



**MEF Standard
MEF 64**

**Operator Layer 1 Service Attributes and
Services**

February 2020

Disclaimer

© MEF Forum 2020. All Rights Reserved.

The information in this publication is freely available for reproduction and use by any recipient and is believed to be accurate as of its publication date. Such information is subject to change without notice and MEF Forum (MEF) is not responsible for any errors. MEF does not assume responsibility to update or correct any information in this publication. No representation or warranty, expressed or implied, is made by MEF concerning the completeness, accuracy, or applicability of any information contained herein and no liability of any kind shall be assumed by MEF as a result of reliance upon such information.

The information contained herein is intended to be used without modification by the recipient or user of this Standard. MEF is not responsible or liable for any modifications to this Standard made by any other party.

The receipt or any use of this Standard or its contents does not in any way create, by implication or otherwise:

- a) any express or implied license or right to or under any patent, copyright, trademark or trade secret rights held or claimed by any MEF member which are or may be associated with the ideas, techniques, concepts or expressions contained herein; nor
- b) any warranty or representation that any MEF members will announce any product(s) and/or service(s) related thereto, or if such announcements are made, that such announced product(s) and/or service(s) embody any or all of the ideas, technologies, or concepts contained herein; nor
- c) any form of relationship between any MEF member and the recipient or user of this Standard.

Implementation or use of specific MEF standards or recommendations and MEF specifications will be voluntary, and no Member shall be obliged to implement them by virtue of participation in MEF Forum. MEF is a non-profit international organization to enable the development and worldwide adoption of agile, assured and orchestrated network services. MEF does not, expressly or otherwise, endorse or promote any specific products or services.

Table of Contents

1	List of Contributing Members	1
2	Abstract	1
3	Terminology and Abbreviations	2
4	Compliance Levels	5
5	Numerical Prefix Conventions	5
6	Introduction	6
6.1	Operator Layer 1 Services Framework.....	8
7	ENNI and Operator Layer 1 Services Characteristics	11
7.1	OTN ENNI Overview.....	11
7.2	ENNI Functional Description.....	12
7.3	ENNI Handoff	14
7.4	Operator L1 Services and L1VCs.....	17
8	Operator Layer 1 Service Attributes Definitions and Requirements	20
8.1	ENNI Common Attributes.....	20
8.1.1	ENNI Peering Identifier Common Attribute	20
8.1.2	ENNI List of Physical Layers Common Attribute	21
8.1.3	ENNI Protection Common Attribute.....	24
8.2	ENNI Service Attributes.....	26
8.2.1	Operator ENNI Identifier Service Attribute.....	26
8.2.2	Operator Multiplexing Capability List Service Attribute.....	27
8.2.3	Operator Path Overhead Service Attribute.....	28
8.3	Operator UNI Service Attributes.....	29
8.3.1	Operator UNI Identifier Service Attribute	29
8.3.2	Operator UNI Physical Layer Service Attribute	29
8.4	Operator L1VC Service Attributes	35
8.4.1	Operator L1VC Identifier Service Attribute	35
8.4.2	Operator L1VC End Point List Service Attribute	36
8.4.3	Operator L1VC Service Level Specification Service Attribute	36
8.5	Operator L1VC End Point Service Attributes	49
8.5.1	Operator L1VC End Point Identifier Service Attribute.....	49
8.5.2	Operator L1VC End Point External Interface Type Service Attribute.....	49
8.5.3	Operator L1VC End Point External Interface Identifier Service Attribute	50
8.5.4	Operator L1VC End Point Map Service Attribute	50
9	Operator Layer 1 Service Definitions and Requirements	53
9.1	Operator Access Layer 1 Service Definition and Requirements.....	53
9.2	Operator Transit Layer 1 Service Definition and Requirements.....	53
10	References	55
Appendix A	Additional Multiplexing Examples (Informative)	57
Appendix B	Relationship Between Operator L1VCs and ODUk Paths (Informative)	60
Appendix C	ENNI Hairpin Connectivity (Informative)	62

Appendix D Evaluation of One-way Errored Second Performance Metric (Informative) 63

Appendix E Use Cases (Informative) 64

 E.1 Router Interconnect 64

 E.2 Enterprise Computing Interconnect..... 70

 E.3 Cloud Computing Access 73

Appendix F Shared ENNI (Informative) 75

List of Figures

Figure 1 – Subscriber L1 Service and Component Operator L1 Service Types.....	6
Figure 2 – Operator L1VC Types	7
Figure 3 – Super Operator and Operator L1 Services Example	8
Figure 4 – Operator L1 Service Definition Framework.....	9
Figure 5 – OTUk Structure for Directly Mapped Client Protocols	11
Figure 6 – OTUk Structure for Mapped & Multiplexed Client Protocols	12
Figure 7 – ENNI Coding and Optical Interface Functions for Directly Mapped Clients	13
Figure 8 – ENNI Coding & Optical Interface Functions for Mapped & Multiplexed Clients	14
Figure 9 – Operator Access and Transit L1 Services Example	15
Figure 10 – ENNI Terminating Function Configurations.....	16
Figure 11 – ENNI Handoff Type 1	16
Figure 12 – ENNI Handoff Type 2	17
Figure 13 – ENNI Handoff Type 3	17
Figure 14 – Operator Access and Transit L1VCs Aggregation Example.....	18
Figure 15 – Operator Transit L1VC Trunked Example.....	19
Figure 16 – 1+1 unidir SNC/I Protected ENNI Handoff Type 1	25
Figure 17 – 1+1 unidir SNC/I Protected ENNI Handoff Type 2.....	25
Figure 18 – 1+1 unidir SNC/I Protected ENNI Handoff Type 3.....	26
Figure 19 – Hierarchy of Time	38
Figure 20 – Example of Detection of Unavailability and Availability	39
Figure 21 – Example of a Maintenance Interval.....	40
Figure 22 – One-way Delay for L1CI.....	41
Figure 23 – Operator Access and Transit L1VCs Example.....	51
Figure 24 – Example of Mapped & Multiplexed Client Protocols over OTLk.4 and OTSiG.....	57
Figure 25 – Example with Directly Mapped Client Protocols included in HO Multiplexing	58
Figure 26 – Example of Mapped & Multiplexed Client Protocols in SHO Multiplexing	59
Figure 27 – Operator L1VCs and ODUk Paths Example	60
Figure 28 – Example of ENNI Hairpin Connectivity	62
Figure 29 – Example Evaluation of the One-way Errored Second Performance Metric.....	63
Figure 30 – Router Interconnect Example	64
Figure 31 – Enterprise Computing Interconnect Example	70
Figure 32 – Cloud Computing Access Example: Subscriber L1VCs	73
Figure 33 – Cloud Computing Access Example: Operator L1VCs	74
Figure 34 – Shared ENNI Example	76

List of Tables

Table 1 – Terminology and Abbreviations	4
Table 2 – Numerical Prefix Conventions.....	5
Table 3 – Value of $\langle OTU_k OH \rangle$	21
Table 4 – Value of $List$ for $\langle HO ODU_k OH \rangle$	22
Table 5 – Optical Interface Function $\langle o \rangle$ Values for OTUk	23
Table 6 – Optical Interface Function $\langle o \rangle$ Values for OTLk.4.....	24
Table 7 – Multiplexing Sequences.....	27
Table 8 – Example Value of the Operator Multiplexing Capability List Service Attribute	28
Table 9 – Value of $List$ for the Operator Path Overhead Service Attribute.....	29
Table 10 – Ethernet Physical Port $\langle c, o \rangle$ Values	30
Table 11 – Fibre Channel Physical Port $\langle c, o \rangle$ Values.....	31
Table 12 – SDH Physical Port $\langle c, o \rangle$ Values.....	33
Table 13 – SONET Physical Port $\langle c, o \rangle$ Values.....	34
Table 14 – Example of an Operator L1VC SLS with One Performance Metric	37
Table 15 – PM Entry for the One-way Delay Performance Metric	41
Table 16 – Errored Client Protocol L1CI Definition	43
Table 17 – Errored ODU L1CI Definition.....	44
Table 18 – PM Entry for the One-way Errored Second Performance Metric	45
Table 19 – Defects and Replacement Signal per Client Protocol in OTN.....	46
Table 20 – Server Defect Detection and Replacement Signal for ODUk.....	46
Table 21 – PM Entry for the One-way Severely Errored Second Performance Metric	47
Table 22 – PM Entry for the One-way Unavailable Second Performance Metric	48
Table 23 – PM Entry for the One-way Availability Performance Metric	49
Table 24 – Example ENNI Common Attribute Values for ENNI 1	65
Table 25 – Example Operator ENNI Service Attribute Values for Operator A at ENNI 1	66
Table 26 – Example Operator UNI Service Attribute Values for Operator A Access L1 Service 1	66
Table 27 – Example Operator L1VC Service Attribute Values for Operator A Access L1 Service 1.....	67
Table 28 – Example Service Attribute Values for the Operator L1VC End Point at ENNI 1 for the Operator A Access L1 Service 1	67
Table 29 – Example Service Attribute Values for the Operator L1VC End Point Maps at ENNI 1 for the Operator A Access L1 Services 2 through 10	67
Table 30 – Example Service Attribute Values for the Operator L1VC End Point at UNI 1 for the Operator A Access L1 Service 1.....	68
Table 31 – Example Operator ENNI Service Attribute Values for the Operator B Transit L1 Service.....	68
Table 32 – Example Operator L1VC Service Attribute Values for the Operator B Transit L1 Service.....	68
Table 33 – Example Service Attribute Values for the Operator L1VC End Points for the Operator B Transit L1 Service	69
Table 34 – Example Service Attribute Values for the Operator L1VC End Point Maps at ENNIs 4 and 5 for the Operator D Access L1 Services 1 and 2	71
Table 35 – Example Service Attribute Values for the Operator L1VC End Point Maps at ENNI 3 for the Operator D Access L1 Services 3 through 10	71



Table 36 – Example Service Attribute Values for the Operator L1VC End Point Maps at ENNIs
3, 4 and 5 for the Operator C Transit L1 Services 72

1 List of Contributing Members

The following members of the MEF participated in the development of this Standard and have requested to be included in this list.

- Bell Canada
- Fujitsu Network Communications
- Nokia

2 Abstract

The Service Attributes of an Operator Layer 1 Service observable at a Layer 1 User Network Interface and a Layer 1 External Network Network Interface are defined. In addition, the Service Attributes of an Operator Access Layer 1 Service between a Layer 1 User Network Interface and Layer 1 External Network Network Interface and the Service Attributes of an Operator Transit Layer 1 Service between a pair of Layer 1 External Network Network Interfaces are defined. A framework for defining specific instances of an Operator Layer 1 Service is also described.

3 Terminology and Abbreviations

This section defines the terms used in this Standard. In many cases, the normative definitions to terms are found in other Standards. In these cases, the third column is used to provide the reference that is controlling, in other MEF or external Standards.

In addition, terms defined in MEF 63 [26] are included in this Standard by reference and are not repeated in the table below.

Term	Definition	Reference
APS	Automatic Protection Switching	ITU-T G.709 [16]
EI	External Interface	This Standard
ENNI	Used within this Standard for brevity when referring to an L1 ENNI.	This Standard
External Interface	Either an L1 UNI or an L1 ENNI.	This Standard
GCC(0,1,2)	General Communication Channel (level 0,1,2)	ITU-T G.709 [16]
Hairpin Connectivity	An Operator Transit L1VC which has its two Operator L1VC End Points in the value of the Operator L1VC End Point List Service Attribute at the same ENNI.	This Standard
HO OPUk/ODUk	An OPUk/ODUk which transports multiple LO OPUk/ODUk	This Standard
HO	Higher Order	This Standard
L1 ENNI	Layer 1 External Network Network Interface.	This Standard
L1 Operator	An organization with administrative control over a network and which provides services to an L1 Super Operator or to an L1 Service Provider.	This Standard
L1 Super Operator	An Operator that uses other Operators to provide connectivity to one of the Operator Layer 1 Virtual Connection End Points of its Operator Layer 1 Virtual Connection.	This Standard
Layer 1 External Network Network Interface	The demarcation point marking the boundary of responsibility between two L1 Operators whose networks are operated as separate administrative domains.	This Standard
LO	Lower Order	This Standard
LO OPUk/ODUk	An OPUk/ODUk which transports a single client protocol	This Standard
ODU	Optical Data Unit	ITU-T G.709 [16]
ODUk	Optical Data Unit-k	ITU-T G.709 [16]
ODUk Path	Optical Data Unit-k Path	ITU-T G.709 [16]
ODU L1CI	Optical Data Unit Layer 1 Characteristic Information	This Standard

Term	Definition	Reference
OH	Overhead	ITU-T G.709 [16]
Operator	Used within this Standard for brevity when referring to an L1 Operator.	This Standard
Operator Access L1VC	Operator Access Layer 1 Virtual Connection	This Standard
Operator Access Layer 1 Service	An Operator Layer 1 Service between an L1 UNI and an L1 ENNI.	This Standard
Operator Access Layer 1 Virtual Connection	An Operator Layer 1 Virtual Connection with one Operator Layer 1 Virtual Connection End Point at an L1 UNI and the other Operator Layer 1 Virtual Connection End Point at an L1 ENNI.	This Standard
Operator L1VC	Operator Layer 1 Virtual Connection	This Standard
Operator L1VC End Point	Operator Layer 1 Virtual Connection End Point	This Standard
Operator Layer 1 Service	A connectivity service provided by an Operator to an L1 Super Operator or to a Service Provider that delivers Layer 1 Characteristic Information between two External Interfaces where at least one External Interface is an L1 ENNI, specified using the Service Attributes in this Standard.	This Standard
Operator Layer 1 Virtual Connection	An association of two Operator Layer 1 Virtual Connection End Points that limits the transport of Layer 1 Characteristic Information between those Operator Layer 1 Virtual Connection End Points where at least one of the Operator Layer 1 Virtual Connection End Points is at an L1 ENNI.	This Standard
Operator Layer 1 Virtual Connection End Point	Represents the logical attachment of an Operator Layer 1 Virtual Connection to a given External Interface.	This Standard
Operator Network	A network used by the Operator to provide services to one or more Service Providers or other Operators.	This Standard
Operator Transit L1VC	Operator Transit Layer 1 Virtual Connection	This Standard
Operator Transit Layer 1 Service	An Operator Layer 1 Service between an L1 ENNI and another L1 ENNI.	This Standard
Operator Transit Layer 1 Virtual Connection	An Operator Layer 1 Virtual Connection with one Operator Layer 1 Virtual Connection End Point at an L1 ENNI and the other Operator Layer 1 Virtual Connection End Point at another L1 ENNI.	This Standard
Operator UNI Service Attribute	Operator UNI Service Attribute values are agreed to by the Service Provider/Super Operator and the Operator.	This Standard

Term	Definition	Reference
Optical Data Unit Layer 1 Characteristic Information	An ODUk frame of a BIP-8 encoded protocol.	This Standard
OPU	Optical Payload Unit	ITU-T G.709 [16]
OPUk	Optical Payload Unit-k	ITU-T G.709 [16]
OSMC	OTN synchronization messaging channel	ITU-T G.709 [16]
OTL	Optical Transport Lane	ITU-T G.709 [16]
OTLk.n	A group of n Optical Transport Lanes that carries one OTUk	ITU-T G.709 [16]
OTN	Optical Transport Network	ITU-T G.709 [16]
OTSi	Optical Tributary Signal	ITU-T G.709 [16]
OTSiG	Optical Tributary Signal Group	ITU-T G.709 [16]
OTU	Optical Transport Unit	ITU-T G.709 [16]
OTUk	Optical Transport Unit-k	ITU-T G.709 [16]
Path Overhead	The APS, GCC, TTI overhead fields of an ODUk	This Standard
Shared ENNI	An ENNI with Operator L1VCs supporting Subscriber L1 Services for more than one Service Provider/Super Operator.	This Standard
SHO	Super Higher Order	This Standard
SHO OPUk/ODUk	An OPUk/ODUk which transports multiple HO OPUk/ODUk	This Standard
SNC/I	Subnetwork Connection protection with Inherent monitoring	ITU-T G.709 [16]
SP/SO	Service Provider/Super Operator	This Standard
Super Operator	Used within this Standard for brevity when referring to an L1 Super Operator.	This Standard
TS	Tributary Slot	ITU-T G.709 [16]
TTI	Trail Trace Identifier	ITU-T G.709 [16]

Table 1 – Terminology and Abbreviations

4 Compliance Levels

The key words "MUST", "MUST NOT", "REQUIRED", "SHALL", "SHALL NOT", "SHOULD", "SHOULD NOT", "RECOMMENDED", "NOT RECOMMENDED", "MAY", and "OPTIONAL" in this Standard are to be interpreted as described in BCP 14 (RFC 2119 [9], RFC 8174 [11]) when, and only when, they appear in all capitals, as shown here. All key words must be in bold text.

Items that are **REQUIRED** (contain the words **MUST** or **MUST NOT**) are labeled as [Rx] for required. Items that are **RECOMMENDED** (contain the words **SHOULD** or **SHOULD NOT**) are labeled as [Dx] for desirable. Items that are **OPTIONAL** (contain the words **MAY** or **OPTIONAL**) are labeled as [Ox] for optional.

5 Numerical Prefix Conventions

This Standard uses the prefix notation to indicate multiplier values as shown in Table 2.

Decimal		Binary	
Symbol	Value	Symbol	Value
k	10 ³	Ki	2 ¹⁰
M	10 ⁶	Mi	2 ²⁰
G	10 ⁹	Gi	2 ³⁰
T	10 ¹²	Ti	2 ⁴⁰
P	10 ¹⁵	Pi	2 ⁵⁰
E	10 ¹⁸	Ei	2 ⁶⁰
Z	10 ²¹	Zi	2 ⁷⁰
Y	10 ²⁴	Yi	2 ⁸⁰

Table 2 – Numerical Prefix Conventions

6 Introduction

This Standard describes Operator Layer 1 (L1) Service Attributes for services provided to an L1 Service Provider (MEF 63 [26]) or L1 Super Operator by an L1 Operator using an Operator L1 Virtual Connection (L1VC) (Section 8.4). An L1 Operator is an organization with administrative control over a network and which provides L1 Services. An L1 Super Operator is an L1 Operator that uses other L1 Operators to provide connectivity to its Operator L1VC End Points (Section 8.5). In this Standard, an L1 Service Provider and L1 Super Operator are referred to as Service Provider and Super Operator, respectively, for brevity. Collectively, they are referred to as SP/SO. An L1 Operator is referred to as Operator for brevity.

The Operator L1 Service Attributes observable at an L1 User Network Interface (UNI) and L1 External Network Network Interface (ENNI) are also defined, which will be referred to as UNI and ENNI, respectively, for brevity in the remainder of this Standard. In addition, the Service Attributes of an Operator Access L1 Service between a UNI and ENNI and the Service Attributes of an Operator Transit L1 Service between a pair of ENNIs are defined.

An Operator Network is a network used by the Operator to provide services to one or more SP/SOs. In the Figure 1 example, Operators C and E provide Access L1 Services (blue), interconnected by the Operator D Transit L1 Service (brown) at ENNIs 1 and 2. Together, the three Operator L1 Services form the connectivity between UNIs 1 and 2 for the Subscriber L1 Service (MEF 63 [26]) provided by the Service Provider, which interconnects the two locations of the Subscriber Network (SN).

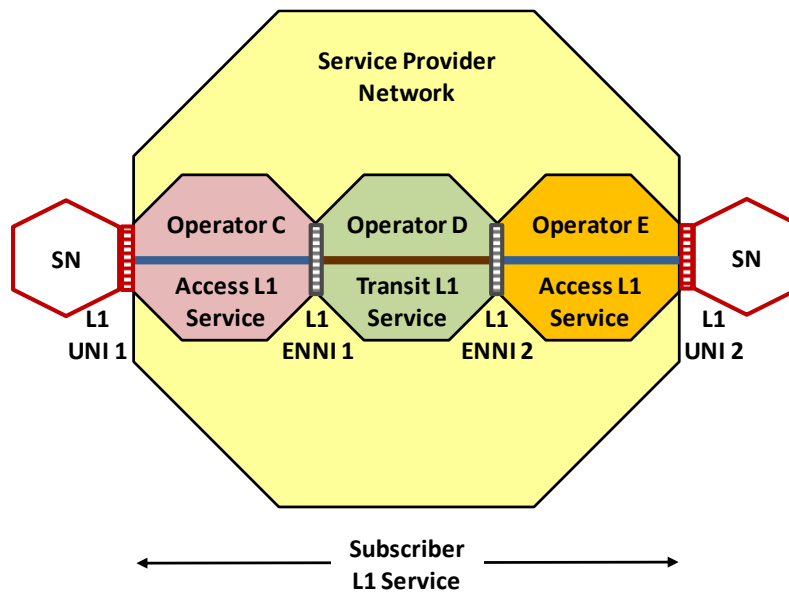

Figure 1 – Subscriber L1 Service and Component Operator L1 Service Types

The equivalent reference model depicting the component Operator L1VC types and associated Operator L1VC End Points is shown in Figure 2. In this Standard, an Operator Access L1 Service is depicted by a solid blue line, while an Operator Transit L1 Service is shown using a solid brown line (as in Figure 1). An Operator Access L1VC, which has one Operator Access L1VC End Point at a UNI and the other Operator Access L1VC End Point at an ENNI, is shown using a dotted blue

line, while an Operator Transit L1VC, which has one Operator Access L1VC End Point at an ENNI and the other Operator Access L1VC End Point at another ENNI, is shown using a dashed brown line (as in Figure 2).

An Operator L1 Service consists of a single Operator L1VC, associated External Interfaces (UNI or ENNI) and Operator L1VC End Points, that is provided by an Operator to a SP/SO.

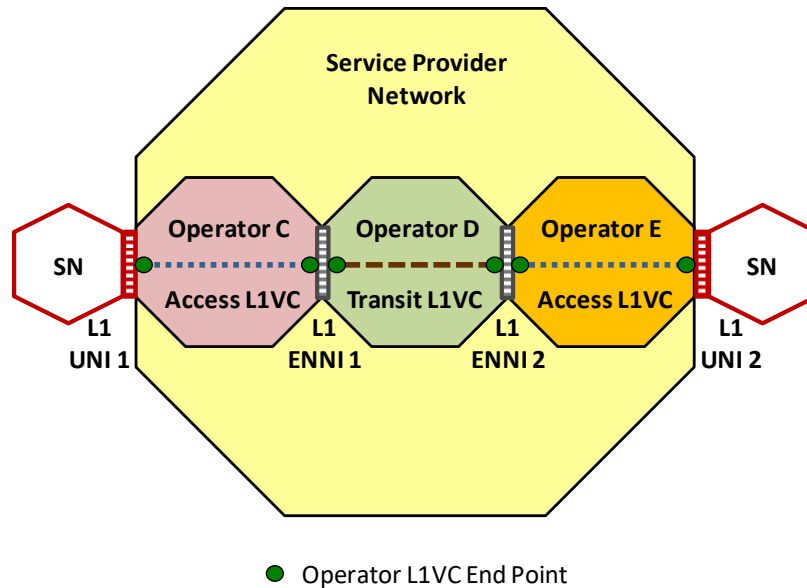

Figure 2 – Operator L1VC Types

The Service Provider can make arrangements for an Operator L1 Service with an Operator which may be acting as a Super Operator. The Super Operator would make arrangements for Operator L1 Services with other Operators (i.e., Operators C and D in this example) not visible to the Service Provider, as in Figure 3.

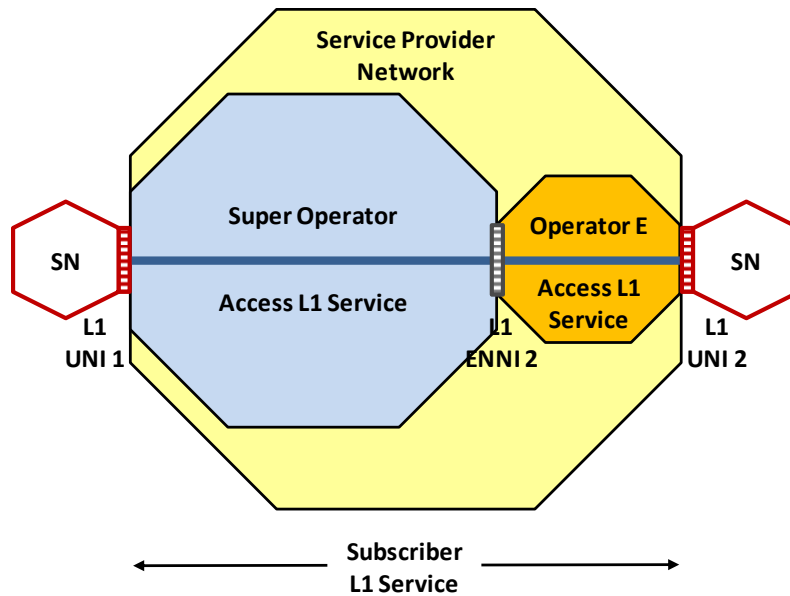

Figure 3 – Super Operator and Operator L1 Services Example

A number of Service Attributes are defined that specify the behavior of an Operator L1 Service including its performance objectives as described in the Service Level Specification (SLS) (Section 8.4.3). This Standard does not define how the Service Attributes are implemented or how SLS compliance is measured or reported. Further, this Standard does not define how an Operator L1 Service is implemented in an Operator’s network. Note that when the term support is used in a normative context in this document, it means that the Operator is capable of enabling the functionality upon agreement between the SP/SO and the Operator.

6.1 Operator Layer 1 Services Framework

The Operator L1 Service definition framework provides a model for specifying an Operator L1 Service. An Operator L1 Service has a set of Service Attributes that define its characteristics. A specific Operator L1 Service is defined by the values of the Service Attributes. This framework is shown in Figure 4.

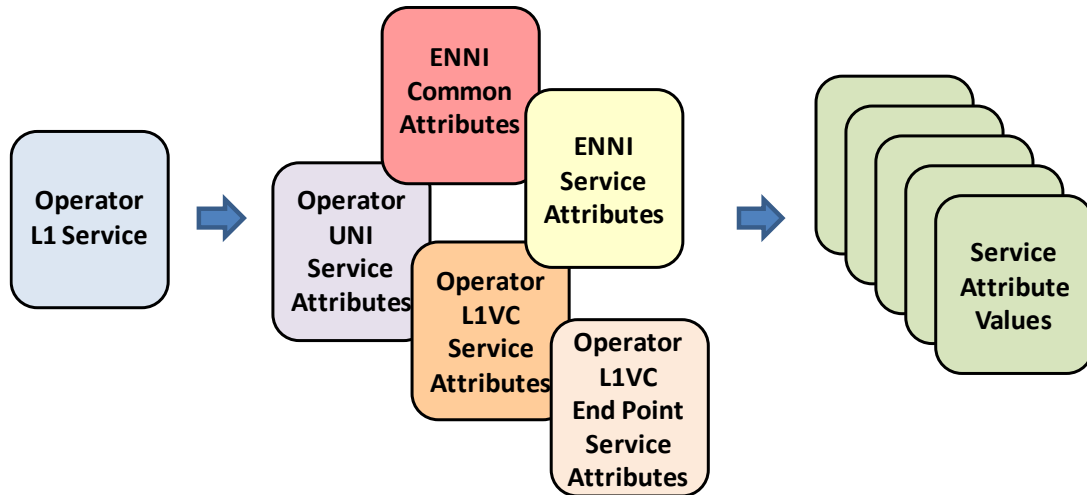

Figure 4 – Operator L1 Service Definition Framework

The Operator L1 Service Attributes and their values apply to a single Operator network. Thus in Figure 1, the Service Provider deals with three sets of Operator L1 Service Attributes and values, one set for each of Operator C, Operator D and Operator E. In addition, the Service Provider agrees with the Subscriber on the values of the Subscriber L1 Service Attributes (MEF 63 [26]). The three sets of Operator L1 Service Attributes and values correspond to the three Operator L1 Services purchased by the Service Provider from the Operators to instantiate the UNI-to-UNI Subscriber L1 Service purchased by the Subscriber from the Service Provider.

The approach is to define Service Attributes that apply to an Operator network. Each Service Attribute can take on one or more values, where the value for a Service Attribute dictates behavior for the Operator network as seen by an external observer. How a behavior is implemented within an Operator network is opaque to the external observer and beyond the scope of this document.

Two kinds of Service Attributes are defined:

- ENNI Common Attributes control Operator network behaviors that enable Operator networks to be interconnected and exchange OTUk frames. The interconnection is achieved by the Operators agreeing on the value for each ENNI Common Attribute.
- Operator Service Attributes control the behavior observable at and between interfaces to an Operator network. The behaviors are achieved by the Operator and the SP/SO agreeing on the value for each Operator Service Attribute.

This document is organized as follows:

- An overview of the ENNI physical layer, functions and relationship to Operator L1 Services and L1VCs is provided in Section 7,
- ENNI Common Attributes are defined in Section 8.1,
- Operator Service Attributes are defined in the following groups
 - ENNI Service Attributes in Section 8.2
 - Operator UNI Service Attributes in Section 8.3
 - Operator L1VC Service Attributes in Section 8.4

- Operator L1VC End Point Service Attributes in Section 8.5.

This Standard then uses those Service Attributes to define Operator L1 Services in Section 9.

7 ENNI and Operator Layer 1 Services Characteristics

To ensure the interconnection of Operator L1 Services, the ENNI physical layer must be specified. This Standard specifies the Optical Transport Network (OTN) defined in ITU-T G.709 [16] and G.872 [19] for the ENNI physical layer. A brief overview of OTN aspects of the ENNI relevant to Operator L1 Services follows in Section 7.1. The OTN physical layer at an ENNI is then described in Section 7.2 in terms of the functions specified by Service Attributes in this Standard. In Section 7.3, those functions are discussed in more detail in the context of ENNI handoff scenarios. Section 7.4 then describes Operator L1 Services and L1VCs in relationship to those ENNI handoffs.

7.1 OTN ENNI Overview

The client protocols, specifically the L1CI in MEF 63 Table 3 [26], are mapped into OTN containers called Lower Order Optical Payload Unit (LO OPU) and Lower Order Optical Data Unit (LO ODU) of corresponding rate, designated by the letter “k”. For the client protocols in Figure 5, there are corresponding physical interfaces at the rate “k” supporting the Optical Transport Unit (OTUk) and Optical Tributary Signal (OTSi)¹, therefore no multiplexing is required (dotted lines). In this Standard, the OTUk structure refers to the OTUk and the hierarchy of OPU/ODU containers and client protocols.

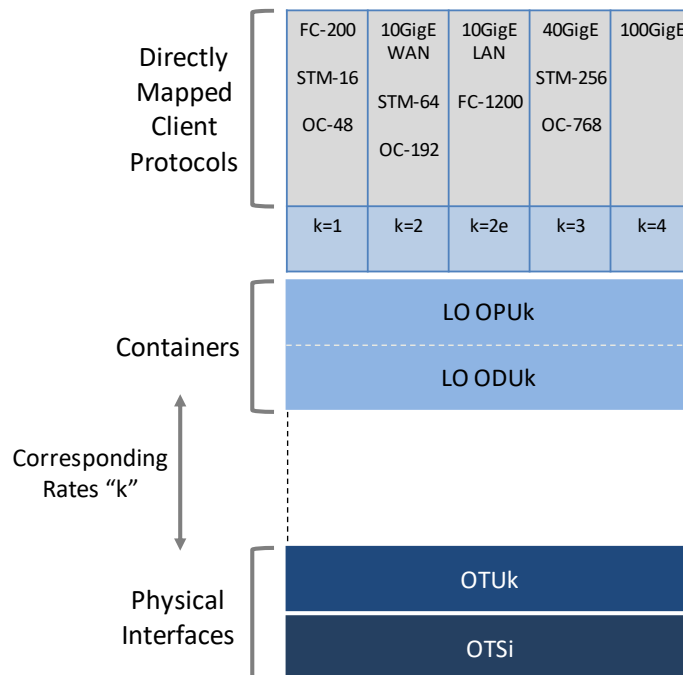

Figure 5 – OTUk Structure for Directly Mapped Client Protocols

For the client protocols in Figure 6 no physical interfaces are defined at the same rate, therefore the LO ODU, using the suffix “j”, must be multiplexed² into a Higher Order (HO) OPUk and HO

¹ Note that the last letter in “OTSi” is the letter “i” from the word “Signal”, it is not an index.

² In this Standard, when the term “multiplex” or “aggregation” is used the equivalent demultiplex or disaggregation capability is implied unless stated otherwise. Similarly, for the opposite usage of the terms.

ODUk which do have defined physical interfaces. Consequently, at the ENNI two basic types of OTUk structures are possible, as illustrated in Figure 5 and Figure 6.

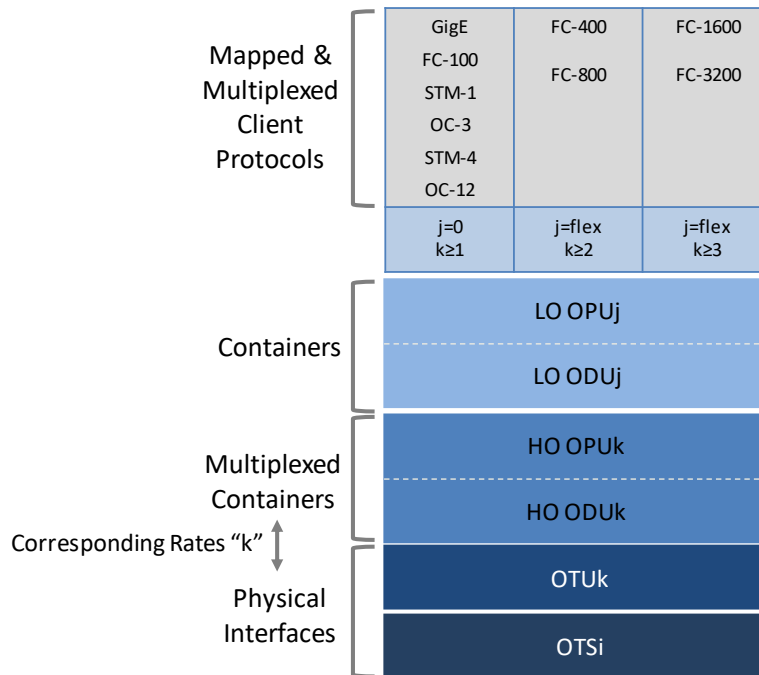

Figure 6 – OTUk Structure for Mapped & Multiplexed Client Protocols

For higher rates of “k”, the OTUk may be split into parallel lanes for transport over lower cost optical modules. The parallel lane structure is referred to as OTLk.n, a group of “n” Optical Transport Lanes (OTL) that carry one OTUk. In this Standard, the value of “n” is always four as that is the implementation currently used in the industry. Specifically, an OTL3.4 carries an OTU3 using four lanes and an OTL4.4 carries an OTU4 using four lanes. The OTLk.4, when utilized, is below the OTUk (see Appendix A). Each of the four lanes is carried over a corresponding OTSi, forming an OTSi Group (OTSiG) (see Appendix A).

7.2 ENNI Functional Description

In this Standard, the ENNI physical layer is specified by two functions: the ENNI Coding Function (Section 8.1.2) and the ENNI Optical Interface Function (Section 8.1.2). The ENNI Optical Interface Function includes the OTSi, which corresponds to a specific rate “k”. The ENNI Coding Function includes the OTLk.4/OTUk and the hierarchy of OPU/ODU containers, which has the two basic structures described above. In Figure 7, the ENNI Coding Function has a single LO OPUk/ODUk with directly mapped client protocols.

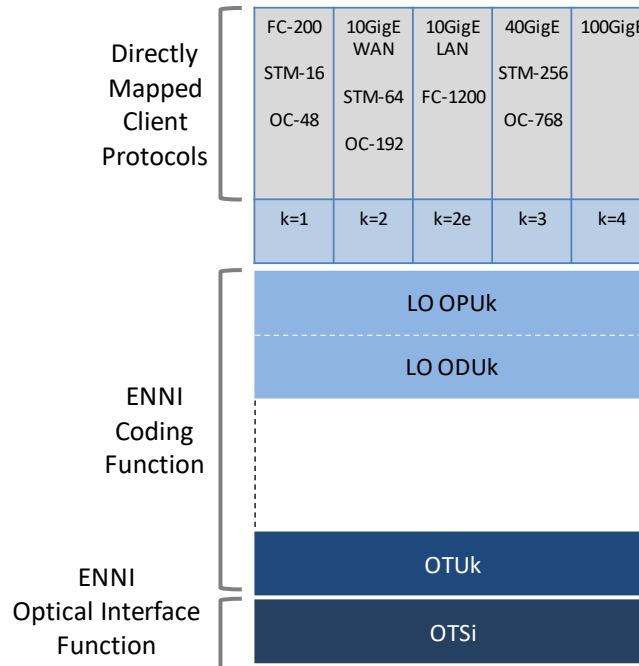

Figure 7 – ENNI Coding and Optical Interface Functions for Directly Mapped Clients

In Figure 8, the ENNI Coding Function has the LO OPU_j/ODU_j for the client protocols without corresponding physical interfaces and which must be multiplexed into a HO OPU_k/ODU_k. Note that the directly mapped client protocols (in LO OPU_j/ODU_j) can also be multiplexed into the HO OPU_k/ODU_k (see Appendix A). Further, the HO OPU_k/ODU_k can be multiplexed (as HO OPU_j/ODU_j) into a Super HO (SHO) OPU_k/ODU_k (see Appendix A).

In this Standard, the OPU/ODU container closest to the OTU_k always has the matching suffix “k”. When there are other OPU/ODU containers in the model stack due to multiplexing, their suffixes take on the preceding letters of the alphabet (i.e., LO OPU_j/ODU_j in single-stage multiplexing to HO OPU_k/ODU_k, or LO OPU_i/ODU_i followed by HO OPU_j/ODU_j in two-stage multiplexing to SHO OPU_k/ODU_k).

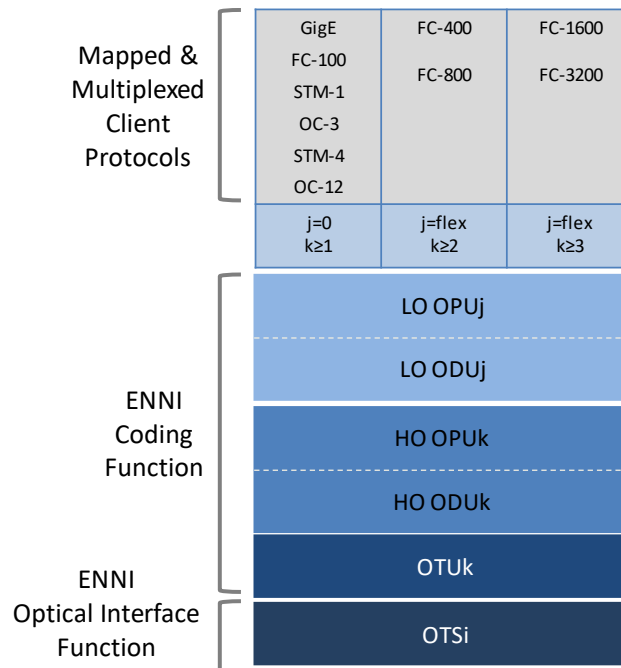

Figure 8 – ENNI Coding & Optical Interface Functions for Mapped & Multiplexed Clients

7.3 ENNI Handoff

At an ENNI, the ENNI Optical Interface Function and the OTLk.4/OTU_k portion of the ENNI Coding Function are always terminated by each Operator. The container above the OTU_k which is exchanged by the two Operators at the ENNI is agreed to by the SP/SO and the Operators. That ODU container, or lower rate ODU containers within it, carries Layer 1 Characteristic Information (L1CI) (MEF 63 [26]). The L1CI that an Operator providing a Transit L1 Service is responsible for delivering from one ENNI to the other ENNI is referred to as ODU L1CI. The ODU L1CI is the entire block of bits in an ODU_k frame ($4 \times 3824 \times 8 = 122,368$ bits) (G.709 [16]). When an Operator aggregates multiple Transit L1 Services the corresponding ODU containers are multiplexed into a higher rate ODU container for exchange at the ENNI. An Operator providing an Access L1 Service is responsible for delivering the client protocol L1CI (MEF 63 [26]) between the corresponding UNI and ENNI, where the client protocol L1CI is within an ODU container at the ENNI. When an Operator aggregates multiple Access L1 Services, the corresponding ODU containers are multiplexed into a higher rate ODU container for exchange at the ENNI. Note that an Operator may provide both an Access L1 Service (blue) and a Transit L1 Service (brown) at an ENNI as illustrated in Figure 9 for Operator D at ENNI 1.

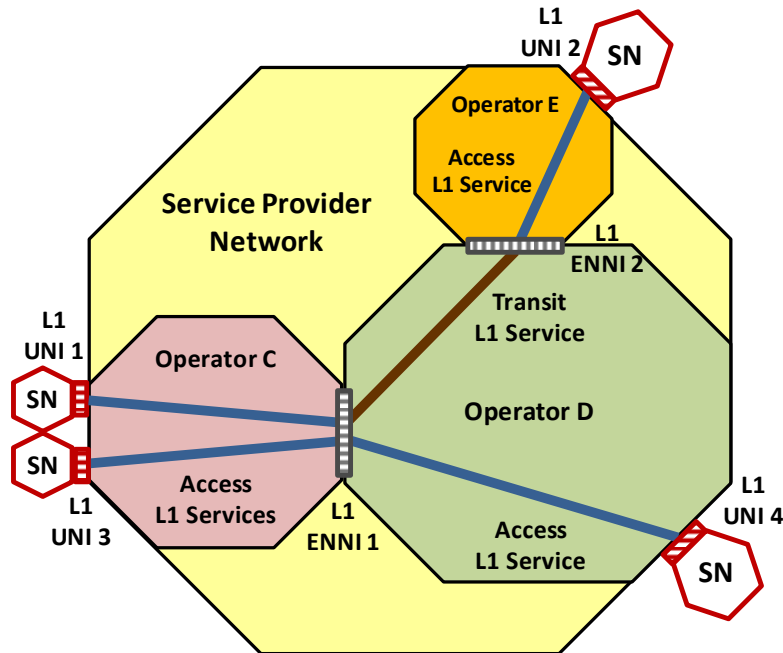

Figure 9 – Operator Access and Transit L1 Services Example

An ODU container that crosses the ENNI may be carried intact or demultiplexed and the lower rate containers within it individually transported, yielding two cases for the terminating functions:

- OTSi and OTUk terminated, or
- OTSi and OTUk plus HO ODUk/OPUk containers terminated.

The latter case is intended to include when a SHO OPUk/ODUk is terminated and its constituent HO OPUj/ODUj or LO OPUi/ODUi are demultiplexed. The term “terminated” includes the processing of overhead. In Figure 10, the two cases of ENNI terminating functions and corresponding overhead fields are illustrated. The description of the OTUk overhead processing is in Section 8.1.2. Descriptions of the HO ODUk overhead processing are in Section 8.1.2 and Section 8.2.3. The description of the ODUj path overhead processing for $j < k$ is in Section 8.2.3.

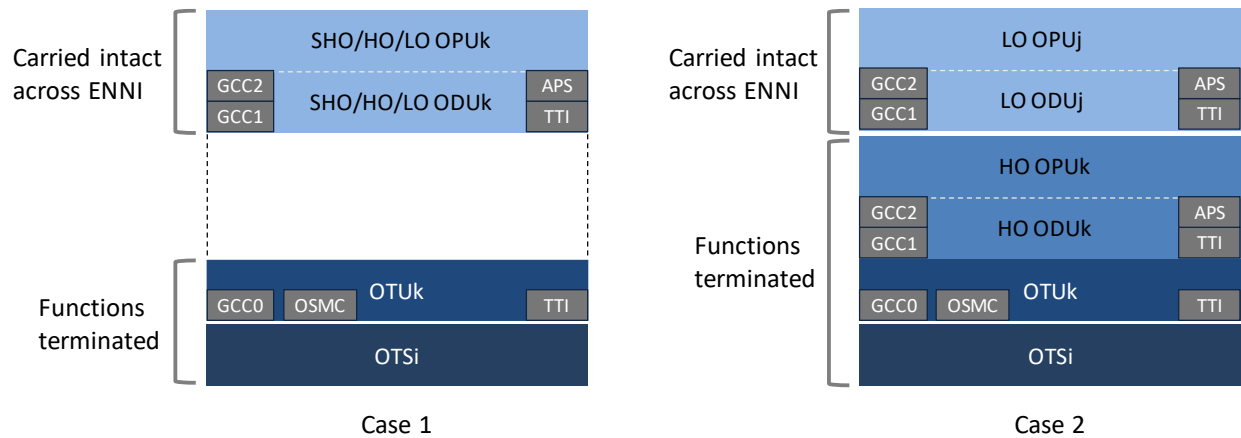

Figure 10 – ENNI Terminating Function Configurations

The two cases of ENNI terminating functions in Figure 10 yield three types of interconnection combinations as shown in Figure 11, Figure 12 and Figure 13.

In Figure 11, the LO ODUk, or HO ODUk, or SHO ODUk container is carried intact across the ENNI.³

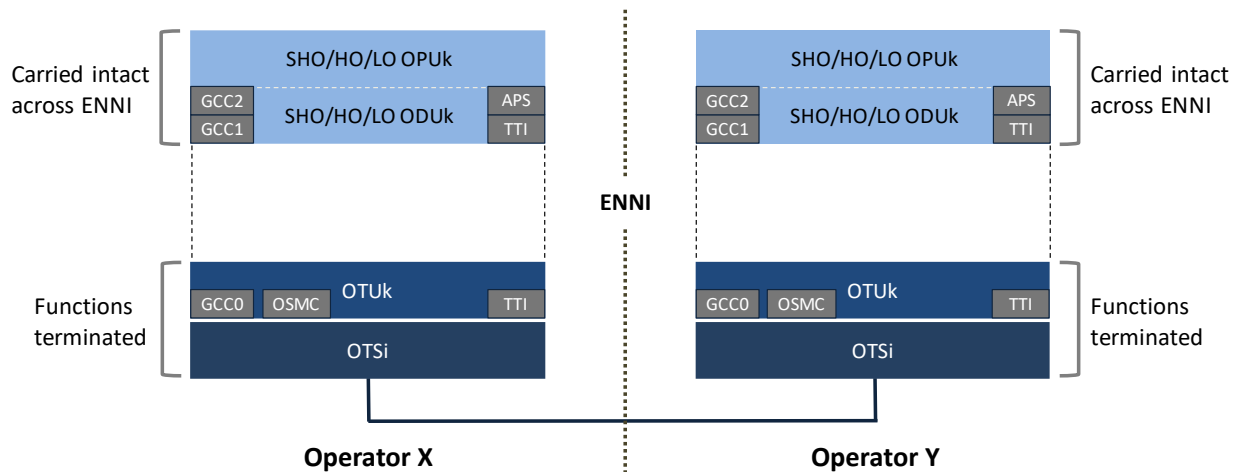

Figure 11 – ENNI Handoff Type 1

In Figure 12, the ODU container from Operator X is terminated by Operator Y and the LO ODUj are demultiplexed from the HO ODUk, or the HO ODUj are demultiplexed from the SHO ODUk. Note this case is intended to include when LO ODUi are further demultiplexed from the HO ODUj.⁴

³ For example, a transponder-to-transponder handoff using grey interfaces (non-ITU-T grid) over the ENNI.

⁴ For example, from an Operator X transponder to an Operator Y OTN multiplexer.

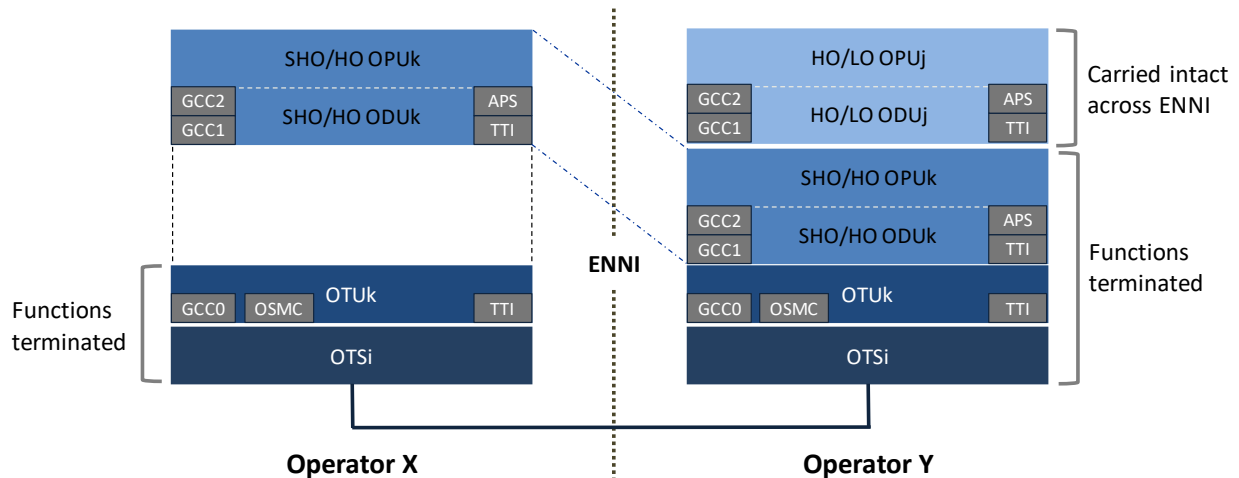

Figure 12 – ENNI Handoff Type 2

In Figure 13, multiplexing of LO ODUj into HO ODUk, or HO ODUj into SHO ODUk is performed by both Operators X and Y. Note this case is intended to include when LO ODUi are multiplexed into the HO ODUj.⁵

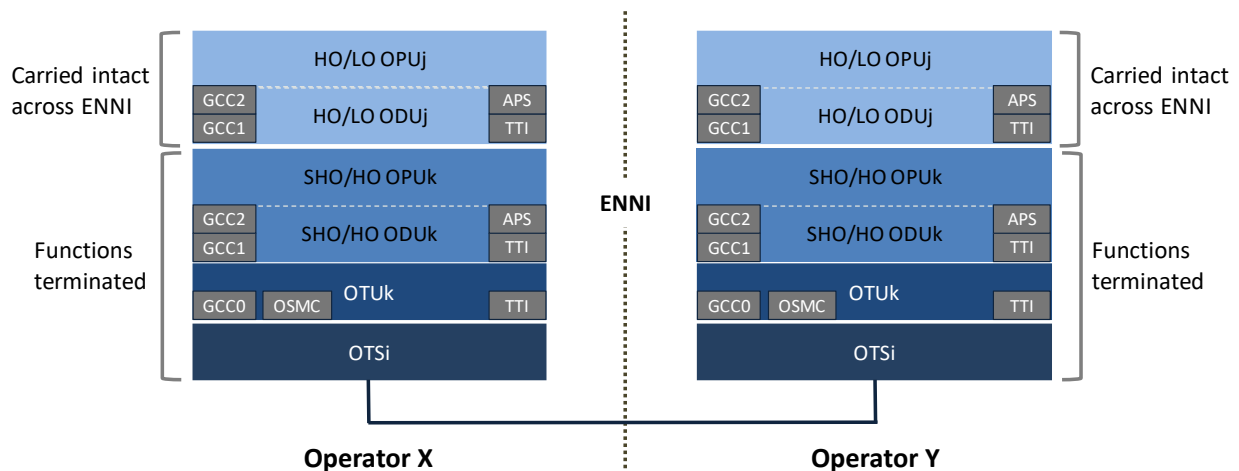

Figure 13 – ENNI Handoff Type 3

7.4 Operator L1 Services and L1VCs

A fundamental aspect of an Operator L1 Service is the Operator L1VC (Section 8.4). An Operator L1VC is an association of two Operator L1VC End Points. An Operator L1VC End Point represents the logical attachment of an Operator L1VC to an External Interface (EI), either a UNI or an ENNI. An Operator Access L1VC transports client protocol L1CI between a UNI and an ENNI, where the client protocol L1CI is within an ODU container when it crosses the ENNI. An Operator Transit L1VC transports ODU L1CI between a pair of ENNIs. The pair of Operator L1VC End Points associated by an Operator L1VC are said to be “in the Operator L1VC”. Consequently, the

⁵ For example, when the Operators have interconnected OTN multiplexers.

corresponding EIs are said to be “in the Operator L1VC”. An Operator L1VC always supports point-to-point, bi-directional (full duplex) transmission of L1CI.

In Figure 14, the Operator Access and Transit L1VCs (and their associated End Points) corresponding to the Figure 9 Operator L1 Services are illustrated. The Operator C Access L1VCs are aggregated at ENNI 1 by multiplexing the traffic mapped to the L1VC End Points into a higher rate (as indicated by the black ellipse) for traversing the ENNI, similarly for the Operator D Access and Transit L1VCs. This approach may be used by the Operators to reduce the number of physical ports and links (i.e., cost) at the ENNI. For the case where the Subscriber L1 Service between UNI 1 and UNI 2 and the Subscriber L1 Service between UNI 3 and UNI 4 are provided by different Service Providers, ENNI 1 is referred to as a Shared ENNI. A Shared ENNI is defined as an ENNI with Operator L1VCs supporting Subscriber L1 Services for more than one SP/SO (see Appendix F). In this example, the ENNI 1 handoff corresponds to the Type 3 shown in Figure 13, while the ENNI 2 handoff corresponds to the Type 1 shown in Figure 11.

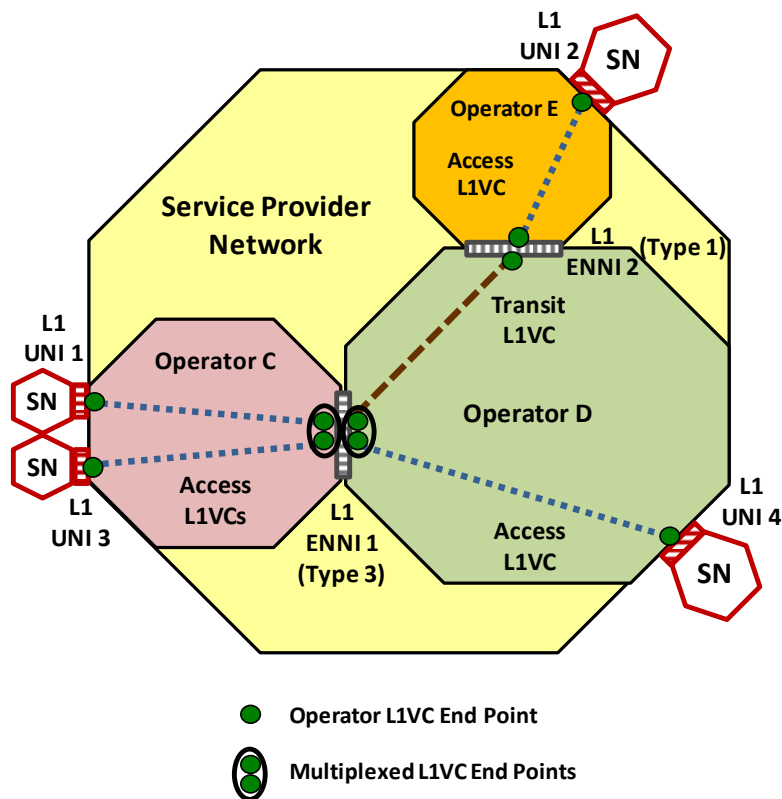

Figure 14 – Operator Access and Transit L1VCs Aggregation Example

For comparison, in Figure 15 the Operator C Access L1VCs which are aggregated at ENNI 1 are transported as a single, higher rate Transit L1VC by Operator D to ENNI 2. In this example, both the ENNI 1 and ENNI 2 handoffs correspond to the Type 2 shown in Figure 12.

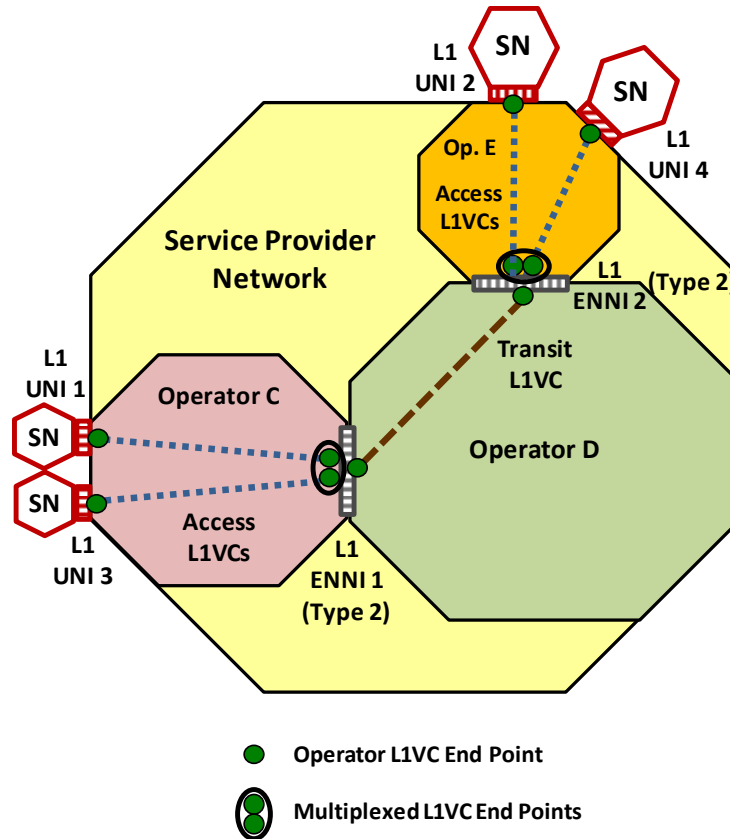

Figure 15 – Operator Transit L1VC Trunked Example

8 Operator Layer 1 Service Attributes Definitions and Requirements

Section 8.1 defines ENNI Common Attributes, which control Operator network behaviors that enable Operator networks to be interconnected and exchange OTUk frames. The interconnection is achieved by the Operators agreeing on the value for each ENNI Common Attribute. Operator Service Attributes are then defined which control the behavior observable at and between interfaces to an Operator network. The behaviors are achieved by the Operator and the SP/SO agreeing on the value for each Operator Service Attribute. The Operator Service Attributes are defined in the following sub-sections:

- Section 8.2 ENNI Service Attributes,
- Section 8.3 Operator UNI Service Attributes,
- Section 8.4 Operator L1VC Service Attributes, and
- Section 8.5 Operator L1VC End Point Service Attributes.

8.1 ENNI Common Attributes

When Operators interconnect their networks to form an ENNI and exchange OTUk frames, several technical details need to be agreed to, such as the physical layer of the links supporting the ENNI. These technical details are called ENNI Common Attributes. The Operators need to agree on the value for each ENNI Common Attribute. The method by which agreement is reached is outside the scope of this Standard. In general, the Operators that need to agree are any Operator that is not a Super Operator and any Super Operator that has arranged for unshared access to the ENNI. A SP/SO that is not party to the agreement of the ENNI Common Attribute values can be aware or unaware of the value for each one. Such organizations may want to be aware of the values since they can influence the decision as to which ENNIs to use.

8.1.1 ENNI Peering Identifier Common Attribute

The ENNI Peering Identifier Common Attribute value is a string used to allow the Operators at the ENNI to uniquely identify the ENNI. It is subject to the following requirements.

- [R1]** The value of the ENNI Peering Identifier Common Attribute **MUST** be unique across all ENNIs for each of the Operators.

If Operators A and B connect via an ENNI with the value of the ENNI Peering Identifier Common Attribute equal to “Toronto Adelaide – Amazon 7”, then [R1] mandates that no other ENNI supported by Operator A have the same value for the ENNI Peering Identifier Common Attribute. The mandate also applies to Operator B.

- [R2]** The value of the ENNI Peering Identifier Common Attribute **MUST** contain no more than 45 characters.⁶

⁶ The limit of 45 characters is intended to establish limits on field lengths in existing or future protocols that will carry the identifier.

[R3] The value of the ENNI Peering Identifier Common Attribute **MUST** be a non-null RFC 2579 [10] DisplayString but not contain the characters 0x00 through 0x1f.

8.1.2 ENNI List of Physical Layers Common Attribute

The value of the ENNI List of Physical Layers Common Attribute is a list of 2-tuples of the form $\langle c, o \rangle$. The $\langle c \rangle$ specifies the Coding Function while the $\langle o \rangle$ specifies wavelength structure, span loss, fibre type and other aspects of the physical layer.

The details for the 2-tuple $\langle c, o \rangle$ are:

- $\langle c \rangle$ is the Coding Function. It is a 3-tuple of the form $\langle k, OTUk\ OH, HO\ ODUk\ OH \rangle$, where:
 - $\langle k \rangle$ is an index representing the OTLk.4/OTUk physical layer line rate.

[R4] The value of $\langle k \rangle$ **MUST** be one of the following values: {1, 2, 2e, 3, 4}.

- $\langle OTUk\ OH \rangle$ is a list of overhead values corresponding to the terminated OTUk, where each entry in the list has the value *Disabled* or *Enabled*.

[R5] The value of $\langle OTUk\ OH \rangle$ **MUST** be a list of three pairs {Field, Value} with each Field and corresponding Value as in Table 3:

Field	Value (1)
OTUk TTI	<i>Disabled</i> or <i>Enabled</i>
OTUk GCC0	<i>Disabled</i> or <i>Enabled</i>
OTUk OSMC	<i>Disabled</i> or <i>Enabled</i>

(1) If the Value is *Enabled* the Operators agree on the values of the parameters (G.709 [16]) for that Field.

Table 3 – Value of $\langle OTUk\ OH \rangle$

- The value of $\langle HO\ ODUk\ OH \rangle$ is either *None* or *List*. When the value of $\langle HO\ ODUk\ OH \rangle$ is *List*, the ENNI is referred to as Type 3 (see Figure 13) and the entries are the overhead values corresponding to the terminated HO ODUk (or SHO ODUk), where each entry in the list has the value *Disabled* or *Enabled*.
- When the value of $\langle HO\ ODUk\ OH \rangle$ is *None*, the ENNI is referred to as either Type 1 (see Figure 11) or Type 2 (see Figure 12).

[R6] When the value of $\langle HO\ ODUk\ OH \rangle$ is *List*, the entries **MUST** be a list of four pairs {Field, Value} with each Field and corresponding Value as in Table 4:

Field	Value (1)
SHO/HO ODUk TTI	<i>Disabled or Enabled</i>
SHO/HO ODUk GCC1	<i>Disabled or Enabled</i>
SHO/HO ODUk GCC2	<i>Disabled or Enabled</i>
SHO/HO ODUk APS	<i>Disabled or Enabled</i>

(1) If the Value is *Enabled* the Operators agree on the values of the parameters (G.709 [16]) for that Field.

Table 4 – Value of List for $\langle HO\ ODUk\ OH \rangle$

- $\langle o \rangle$ is the Optical Interface Function.

[R7] The value of $\langle o \rangle$ corresponding to the index $\langle k \rangle$ in the entry $\langle c \rangle$ **MUST** be one of the Optical Interface Function values in either Table 5 (OTUk) or Table 6 (OTLk.4).

In Table 5, the values of $\langle k \rangle$ are grouped into Classes defined in G.959.1 [22]. Within a Class there are several possible values for the Optical Interface Function $\langle o \rangle$. The references in the column G.959.1 [22] are to tables in that Recommendation which provide more details for each of the values of $\langle o \rangle$.

k	Class	Optical Interface Function $\langle o \rangle$ Values	G.959.1 [22]
1	NRZ 2.5G (~622 Mb/s to 2.67 Gb/s)	P16S1-1D2, P32S1-1D2, P16S1-1D5, P32S1-1D5	[Table 5-3]
		P16L1-1A2, P16L1-1A5	[Table 5-4]
		P1I1-1D1	[Table 5-5]
		P1S1-1D1, P1S1-1D2	[Table 5-6]
		P1L1-1D1, P1L1-1D2, 1L1-1D2F	[Table 5-7]
		P1U1-1A2, 1U1-1B2F, P1U1-1A3, 1U1- 1B3F, P1U1-1A5, 1U1-1B5F	[Table 5-9]
2, 2e	NRZ 10G (~2.4 Gb/s to 10.76 Gb/s) Note 2e is 11.0957 Gb/s.	P4I1-2D1, 4I1-2D1F, P16I1-2D2, P32I1- 2D2, P16I1-2D3, P16I1-2D5, P32I1-2D5	[Table 5-2]
		P16S1-2B2, P16S1-2C2, P32S1-2B2, P32S1-2C2, P16S1-2C3, P16S1-2B5, P16S1-2C5, P32S1-2B5, P32S1-2C5	[Table 5-3]
		P16L1-2A2, P16L1-2A5	[Table 5-4]
		P1I1-2D1r, P1I1-2D1, P1I1-2D2r, P1I1- 2D2, P1I1-2D3, P1I1-2D5	[Table 5-5]
		P1S1-2D1, P1S1-2D2a,b, 1S1-2D2bF, P1S1-2D3a,b, 1S1-2D3bF, P1S1-2D5a,b, 1S1-2D5bF	[Table 5-6]
		P1L1-2D1, P1L1-2D2, 1L1-2D2F, P1L1- 2D2E, 1L1-2D2FE	[Table 5-7]
		P1V1-2C2, 1V1-2C2F, P1V1-2B2E, 1V1- 2B2FE, P1V1-2B5, 1V1-2B5F	[Table 5-8]
3	NRZ 40G (~9.9 Gb/s to 43.02 Gb/s)	P1I1-3D1, 1I1-3D1F, P1I1-3D3, P1I1-3D5	[Table 5-5]
		P1S1-3D1, 1S1-3D1F, P1S1-3C2, P1S1- 3C3, P1S1-3C5	[Table 5-6]
		P1L1-3C1, 1L1-3C1F, P1L1-3A2, 1L1- 3C2F, 1L1-3C2FD, P1L1-3A3, 1L1-3C3F, 1L1-3C3FD, P1L1-3A5, 1L1-3C5F, 1L1- 3C5FD	[Table 5-7]
		P1L1-7A2, P1L1-7A3, P1L1-7A5	[Table 5-7]
	RZ 40G (~9.9 Gb/s to 43.02 Gb/s)		

Table 5 – Optical Interface Function $\langle o \rangle$ Values for OTUk

In Table 6, the values of $\langle k \rangle$ are grouped into Classes defined in G.959.1 [22] and G.695 [14]. Within a Class there are several possible values for the Optical Interface Function $\langle o \rangle$. The references in the columns G.959.1 [22] and G.695 [14] are to tables within those Recommendations which provide more details for each of the values of $\langle o \rangle$. Appendix E.1 includes an example value of an Optical Interface Function.

k	Class	Optical Interface Function $\langle o \rangle$ Values	G.959.1 [22]	G.695 [14]
3	NRZ 10G (~2.4 Gb/s to 10.76 Gb/s)	P4I1-2D1, 4I1-2D1F, P16I1-2D2, P32I1-2D2, P16I1-2D3, P16I1-2D5, P32I1-2D5	[Table 5-2]	
		P16S1-2B2, P16S1-2C2, P32S1-2B2, P32S1-2C2, P16S1-2C3, P16S1-2B5, P16S1-2C5, P32S1-2B5, P32S1-2C5	[Table 5-3]	
		P16L1-2A2, P16L1-2A5	[Table 5-4]	
		C4S1-2D1, C4L1-2D1		[Table 5-1]
4	NRZ 25G (~9.9 Gb/s to 28 Gb/s)	4I1-9D1F	[Table 5-2]	
		4L1-9C1F, 4L1-9D1F	[Table 5-4]	
		C4S1-9D1F		[Table 5-1]

Table 6 – Optical Interface Function $\langle o \rangle$ Values for OTLk.4

8.1.3 ENNI Protection Common Attribute

The ENNI Protection Common Attribute value specifies the protection protocol deployed at the ENNI for the ODU container exchanged by the Operators (Section 7.3). The ENNI Protection Common Attribute value is either:

- *None*, or
- *One of the rows* as specified in G.873.1 Section 8.5, Table 8-1 [20].

[R8] When the value of the ENNI Protection Common Attribute is not *None* the number of $\langle c, o \rangle$ entries in the ENNI List of Physical Layers Common Attribute **MUST** be as indicated in G.873.1 Section 8.5, Table 8-1, column *Protection architecture* (i.e., two entries for 1+1; n+1 entries for 1:n).

The simplest ENNI Protection Common Attribute value listed in G.873.1 Section 8.5, Table 8-1 is in the first row, specifically *1+1 unidir SNC/I* (uni-directional, Subnetwork Connection with Inherent monitoring). With this value, an APS signaling channel (i.e., Protection Communication Channel – PCC) is not required (G.873.1 [20]). Further, agreement between the Operators on the value of revertive/non-revertive mode is not required, as a mismatch of this parameter does not prevent interworking (G.873.1 [20]).

[D1] When the value of the ENNI Protection Common Attribute is not *None* the value **SHOULD** be *1+1 unidir SNC/I*.

The specification of a protection protocol for a region within an Operator’s network is outside the scope of this Standard.

Figure 16, Figure 17 and Figure 18 illustrate the three ENNI handoff types (Section 7.3) when the ENNI Protection Common Attribute has the value *1+1 unidir SNC/I*. The Bridge function is 1+1 (the same traffic is sent to both OTUK sublayers) and the Selector function selects one of the two received traffic flows (from one OTUK sublayer).

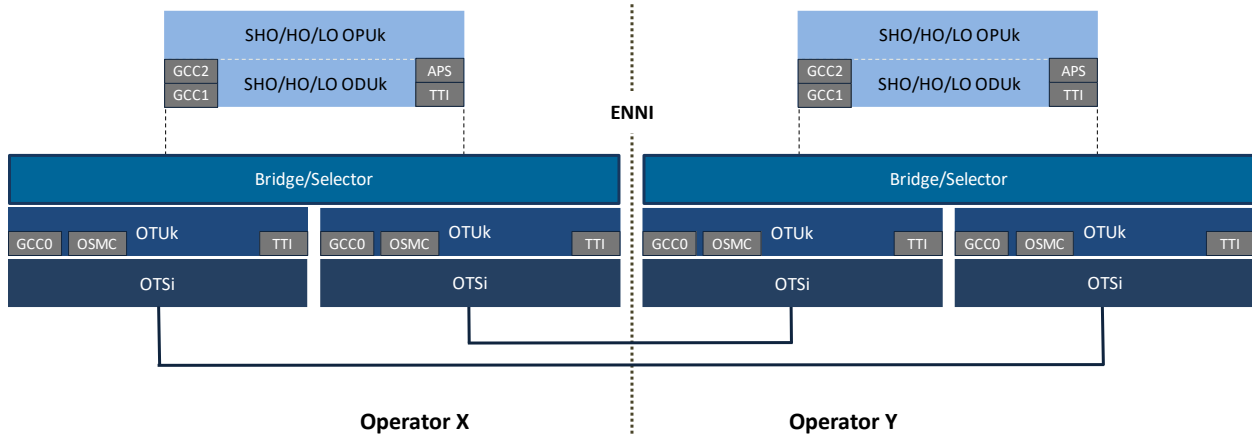

Figure 16 – 1+1 unidir SNC/I Protected ENNI Handoff Type 1

Note that the APS field in the Figure 16 SHO/HO/LO ODUk sublayer is not related to the ENNI protection.

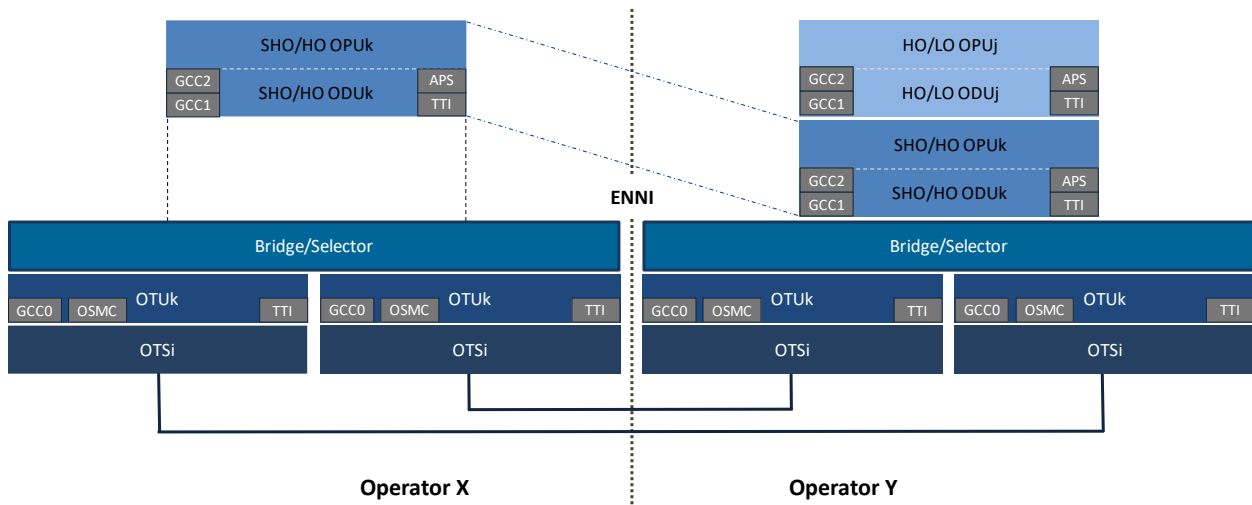

Figure 17 – 1+1 unidir SNC/I Protected ENNI Handoff Type 2

Note that the APS field in the Figure 17 HO/LO ODUj sublayer and the APS field in the SHO/HO ODUk sublayer are not related to the ENNI protection.

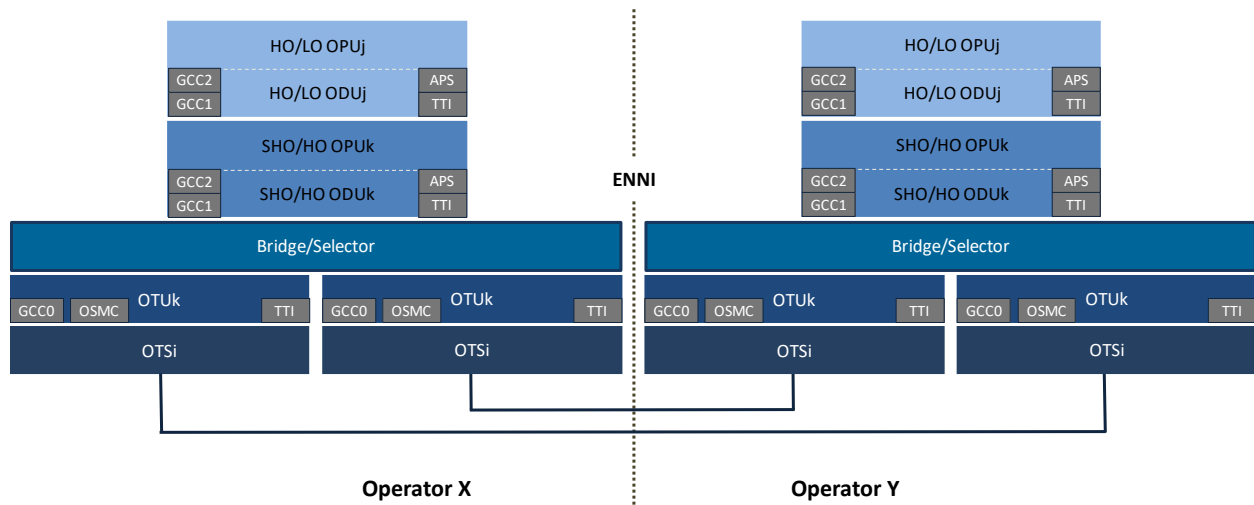

Figure 18 – 1+1 unidir SNC/I Protected ENNI Handoff Type 3

Note that the APS field in the Figure 18 HO/LO ODUj sublayer and the APS field in the SHO/HO ODUk sublayer are not related to the ENNI protection.

8.2 ENNI Service Attributes

For each instance of an ENNI, there are multiple sets of ENNI Service Attributes. The value for each ENNI Service Attribute in a set for an Operator network is specific to the SP/SO that is using the ENNI. Each such value is agreed to by the SP/SO and the Operator. The methods and procedures for reaching agreement are beyond the scope of this Standard.

8.2.1 Operator ENNI Identifier Service Attribute

The Operator ENNI Identifier Service Attribute value is a string used to allow the SP/SO and Operator to uniquely identify the ENNI.

- [R9]** The value of the Operator ENNI Identifier Service Attribute **MUST** be unique across all ENNIs supported by the Operator.
- [R10]** The value of the Operator ENNI Identifier Service Attribute **MUST** contain no more than 45 characters.⁷
- [R11]** The value of the Operator ENNI Identifier Service Attribute **MUST** be a non-null RFC 2579 [10] DisplayString but not contain the characters 0x00 through 0x1f.

⁷ The limit of 45 characters is intended to establish limits on field lengths in existing or future protocols that will carry the identifier.

8.2.2 Operator Multiplexing Capability List Service Attribute

The value of the Operator Multiplexing Capability List Service Attribute indicates the Operator’s ability to multiplex a given LO ODU_j into a HO ODU_k (single-stage), or multiplex a given LO ODU_i into a HO ODU_j and into a SHO ODU_k (two-stage), or more multiplexing stages. This information is used by the SP/SO to determine if an Operator can provide the required multiplexing to form the ODU container exchanged between Operators at an ENNI (Section 7.3).

Note that this is a capability Service Attribute, it does not provide information regarding the assignment of an Operator L1VC End Point to a multiplexing sequence. The assignment of an Operator L1VC End Point to a multiplexing sequence (e.g., an ODU0 in an ODU0-ODU2-ODU4 multiplexing sequence) is described by the Operator L1VC End Point Map Service Attribute (see Section 8.5.4). Note that the value *Null* is used to indicate no multiplexing capability.

Table 7 lists the possible multiplexing sequences for a given LO ODU into a HO ODU using a nomenclature similar to OIF ENNI [27]. Each HO ODU column lists each possible multiplexing sequence in a separate row. For example, there are eight possible multiplexing sequences for a LO ODU0 into a HO ODU4.

LO Entity	Multiplexing Sequences			
	HO ODU4	HO ODU3	HO ODU2	HO ODU1
ODU0	ODU0-ODU1-ODU2-ODU3-ODU4: 64	ODU0-ODU1-ODU2-ODU3: 32	ODU0-ODU1-ODU2: 8	ODU0-ODU1: 2
	ODU0-ODU1-ODU3-ODU4: 64	ODU0-ODU1-ODU3: 32	ODU0-ODU2: 8	
	ODU0-ODU1-ODU2-ODU4: 80	ODU0-ODU2-ODU3: 32		
	ODU0-ODU1-ODU4: 80	ODU0-ODU3: 32		
	ODU0-ODU2-ODU3-ODU4: 64			
	ODU0-ODU2-ODU4: 80			
	ODU0-ODU3-ODU4: 64			
	ODU0-ODU4: 80			
ODU1	ODU1-ODU2-ODU3-ODU4: 32	ODU1-ODU2-ODU3: 16 (1.25TS)	ODU1-ODU2: 4 (1.25TS)	
	ODU1-ODU2-ODU4: 40	ODU1-ODU2-ODU3: 16 (2.5TS)	ODU1-ODU2: 4 (2.5TS)	
	ODU1-ODU3-ODU4: 32	ODU1-ODU3: 16 (1.25TS)		
	ODU1-ODU4: 40	ODU1-ODU3: 16 (2.5TS)		
ODUflex	ODUflex-ODU2-ODU3-ODU4: 10G	ODUflex-ODU2-ODU3: 10G	ODUflex-ODU2: 10G	
	ODUflex-ODU2-ODU4: 10G	ODUflex-ODU3: 40G		
	ODUflex-ODU3-ODU4: 40G			
	ODUflex-ODU4: 100G			
ODU2	ODU2-ODU3-ODU4: 8	ODU2-ODU3: 4 (1.25TS)		
	ODU2-ODU4: 10	ODU2-ODU3: 4 (2.5TS)		
ODU2e	ODU2e-ODU3-ODU4: 6	ODU2e-ODU3: 3		
	ODU2e-ODU4: 10			
ODU3	ODU3-ODU4: 2			

Table 7 – Multiplexing Sequences

The number following a given multiplexing sequence indicates the maximum quantity of LO ODU which can be multiplexed (e.g., ODU0-ODU1-ODU2-ODU4: 80, indicates that up to 80 LO ODU0 can be multiplexed in that sequence of HO ODU). For the case of a LO ODUflex, the number indicates the approximate maximum bit rate which can be multiplexed (e.g., ODUflex-ODU2-ODU4: 10G, indicates that a LO ODUflex up to 10Gb/s can be multiplexed in that sequence). The suffix (1.25TS) or (2.5TS) indicates whether the HO ODU_k, for k={2, 3} supports 1.25Gb/s Tributary Slots (TS) or 2.5Gb/s TS when multiplexing LO ODU_j, for j={1, 2}.

The value of the Operator Multiplexing Capability List Service Attribute is either *Null* or at least one multiplexing sequence entry from Table 7. A multiplexing sequence entry in the list indicates that the Operator might agree to instantiating the multiplexing scheme. Additional steps are necessary to reserve and assign capacity for use by the SP/SO (i.e., establish a value for the Operator L1VC End Point Map Service Attribute in Section 8.5.4). Such procedures are beyond the scope of this Standard.

Note the value of *k*, which is specified in the value of the ENNI List of Physical Layers Common Attribute (Section 8.1.2), places a limit on the highest rate of HO ODU multiplexing sequence possible.

- [R12] When the value of the Operator Multiplexing Capability List Service Attribute is not *Null*, the value of the Operator Multiplexing Capability List Service Attribute **MUST** be from the HO ODU column in Table 7 corresponding to the value of *k* which is specified in the value of the ENNI List of Physical Layers Common Attribute (Section 8.1.2).

An example value of the Operator Multiplexing Capability List Service Attribute when the value of *k* = 4 (i.e., from the Table 7 column HO ODU4) is provided in Table 8.

Operator Multiplexing Capability List
ODU0-ODU1-ODU4: 80
ODU0-ODU4: 80
ODU1-ODU2-ODU4: 40
ODU1-ODU4: 40
ODUflex-ODU2-ODU4: 10G
ODUflex-ODU4: 100G
ODU2-ODU4: 10
ODU2e-ODU4: 10

Table 8 – Example Value of the Operator Multiplexing Capability List Service Attribute

8.2.3 Operator Path Overhead Service Attribute

An ODU path is the connectivity between the locations where the path overhead is terminated. ITU-T G.709 [16] defines an ODU_k path. The value of the Operator Path Overhead Service Attribute is either *None* or *List*. When the value of the Operator Path Overhead Service Attribute is *List*, the entries are the overhead values corresponding to each of the SHO/HO/LO ODU paths carried across an ENNI which is terminated in an Operator’s network. Each entry in the list has the value *Disabled* or *Enabled*. When there is no ODU path terminated in an Operator’s network, the value of the Operator Path Overhead Service Attribute is *None*.

- [R13] When the value of the Operator Path Overhead Service Attribute is *List*, the value of the Operator Path Overhead Service Attribute **MUST** be a list of four pairs {Field, Value} for each path terminated in the Operator’s network, with each Field and corresponding Value as in Table 9:

Field	Value (1)
ODU TTI	<i>Disabled or Enabled</i>
ODU GCC1	<i>Disabled or Enabled</i>
ODU GCC2	<i>Disabled or Enabled</i>
ODU APS	<i>Disabled or Enabled</i>

(1) If the Value is *Enabled* the SP/SO and Operator coordinate the provisioning of the parameters (G.709 [16]) for that Field.

Table 9 – Value of *List* for the Operator Path Overhead Service Attribute

Note that Appendix B discusses the relationship between Operator L1VCs, ODUk paths, Operator L1VC End Points and ODUk path overhead termination. The Operator Path Overhead Service Attribute value for each Operator in a network example is also discussed.

8.3 Operator UNI Service Attributes

The Operator UNI Service Attribute values are agreed to by the SP/SO and the Operator. It is important to note that the Operator UNI Service Attributes are different from the Subscriber UNI Service Attributes detailed in MEF 63 [26]. They are different because the value of each Operator UNI Service Attribute is agreed to by the SP/SO and the Operator, while the value of each Subscriber UNI Service Attribute is agreed to by the Subscriber and the Service Provider. Note that the value of the Operator UNI Physical Layer Service Attribute and the value of the Subscriber UNI Physical Layer Service Attribute need to be the same, while the value of the Operator UNI Identifier Service Attribute and the value of the Subscriber UNI Identifier Service Attribute can be different.

8.3.1 Operator UNI Identifier Service Attribute

The value of the Operator UNI Identifier Service Attribute is a string that is used to allow the SP/SO and Operator to uniquely identify the UNI.

- [R14] The value of the Operator UNI Identifier Service Attribute **MUST** be unique across all UNIs supported by the Operator.
- [R15] The value of the Operator UNI Identifier Service Attribute **MUST** contain no more than 45 characters.⁸
- [R16] The value of the Operator UNI Identifier Service Attribute **MUST** be a non-null RFC 2579 [10] DisplayString but not contain the characters 0x00 through 0x1f.

8.3.2 Operator UNI Physical Layer Service Attribute

The Operator UNI Physical Layer Service Attribute specifies the Client Protocol, the Coding Function and the Optical Interface Function used by the Operator for the physical link implementing

⁸ The limit of 45 characters is intended to establish limits on field lengths in existing or future protocols that will carry the identifier.

the UNI. A Physical Port is defined in MEF 63 [26] as the combination of one Coding Function and one Optical Interface Function. Note that primarily Single-Mode Fibre (SMF) Optical Interface Functions are considered as they are more commonly deployed for higher rate interfaces. The value of the Operator UNI Physical Layer Service Attribute is a 3-tuple of the form $\langle p, c, o \rangle$ where:

- p is the Client Protocol, and
- c is the Coding Function, and
- o is the Optical Interface Function.

[R17] The Client Protocol $\langle p \rangle$ **MUST** be one of the following values:

- *Ethernet*, or
- *Fibre Channel*, or
- *SDH*, or
- *SONET*.

[R18] When p has the value *Ethernet*, the 3-tuple $\langle Ethernet, c, o \rangle$ **MUST** use one of the 13 possible $\langle c, o \rangle$ values for the Coding Function and Optical Interface Function shown in Table 10:

Coding Function $\langle c \rangle$ (1)	Optical Interface Function $\langle o \rangle$ (1)
1000BASE-X PCS clause 36 coding function	SX PMD clause 38
	LX PMD clause 38
	LX10 PMD clause 59
	BX10 PMD clause 59
10GBASE-W (WAN PHY) PCS clause 49 and WIS clause 50 coding function	LW PMD clause 52
	EW PMD clause 52
10GBASE-R (LAN PHY) PCS clause 49 coding function	LR PMD clause 52
	ER PMD clause 52
40GBASE-R PCS clause 82 coding function	LR4 PMD clause 87
	ER4 PMD clause 87
	FR PMD clause 89
100GBASE-R PCS clause 82 coding function	LR4 PMD clause 88
	ER4 PMD clause 88

(1) The clause references are in IEEE Std 802.3 [8].

Table 10 – Ethernet Physical Port $\langle c, o \rangle$ Values

Note that each Coding Function reference and Optical Interface Function reference includes the bit rate.

For example, if the value of the Client Protocol $\langle p \rangle$ is *Ethernet*, then $\langle c, o \rangle$ could be $\langle 10GBASE-R PCS clause 49 coding function, LR PMD clause 52 \rangle$.

Another example of $\langle c, o \rangle$ for an *Ethernet Client Protocol* is $\langle 10GBASE-R PCS clause 49 coding function, ER PMD clause 52 \rangle$.

[R19] When p has the value *Fibre Channel*, the 3-tuple $\langle \textit{Fibre Channel}, c, o \rangle$ **MUST** use one of the 10 possible $\langle c, o \rangle$ values for the Coding Function and Optical Interface Function shown in Table 11:

Coding Function $\langle c \rangle$	Optical Interface Function $\langle o \rangle$
FC-100 (1.0625 Gb/s) FC-FS-2 [3] clause 5 FC-1 8B/10B coding function	FC-PI-2 [2] clause 6.3 FC-0 100-SM-LC-L
FC-200 (2.125 Gb/s) FC-FS-2 [3] clause 5 FC-1 8B/10B coding function	FC-PI-2 [2] clause 6.3 FC-0 200-SM-LC-L
FC-400 (4.250 Gb/s) FC-FS-2 [3] clause 5 FC-1 8B/10B coding function	FC-PI-5 [5] clause 6.3 FC-0 400-SM-LC-L
	FC-PI-5 [5] clause 6.3 FC-0 400-SM-LC-M
FC-800 (8.500 Gb/s) FC-FS-2 [3] clause 5 FC-1 8B/10B coding function	FC-PI-5 [5] clause 6.3 FC-0 800-SM-LC-L
	FC-PI-5 [5] clause 6.3 FC-0 800-SM-LC-I
FC-1200 (10.51875 Gb/s) FC-10GFC [1] clause 13 FC-1 coding function	FC-10GFC [1] clause 6.4 FC-0 1200-SM-LL-L
FC-1600 (14.025 Gb/s) FC-FS-3 [4] clause 5 FC-1 64B/66B coding function	FC-PI-5 [5] clause 6.3 FC-0 1600-SM-LC-L
	FC-PI-5 [5] clause 6.3 FC-0 1600-SM-LZ-I
FC-3200 (28.05 Gb/s) FC-FS-4 [6] clause 5 FC-1 64B/66B coding function plus 256B/257B transcoding and FEC encoding	FC-PI-6 [7] clause 5.3 FC-0 3200-SM-LC-L

Table 11 – Fibre Channel Physical Port $\langle c, o \rangle$ Values

Note that the bit rate is specified for each Coding Function because the reference is bit rate independent. The bit rate of 28.05 Gb/s for the FC-3200 Coding Function corresponds to both the 64B/66B encoded L1CI bit rate and the bit rate after 256B/257B transcoding and FEC encoding (i.e., those two codings do not alter the bit rate). Each Optical Interface Function reference includes the bit rate.

For example, if the value of the Client Protocol (p) is *Fibre Channel*, then $\langle c, o \rangle$ could be $\langle FC-800 (8.500 Gb/s) FC-FS-2 clause 5 FC-1 8B/10B coding function, FC-PI-5 clause 6.3 FC-0 800-SM-LC-L \rangle$.

Another example of $\langle c, o \rangle$ for a *Fibre Channel Client Protocol* is $\langle FC-800 (8.500 Gb/s) FC-FS-2 clause 5 FC-1 8B/10B coding function, FC-PI-5 clause 6.3 FC-0 800-SM-LC-I \rangle$.

[R20] When p has the value *SDH*, the 3-tuple $\langle SDH, c, o \rangle$ **MUST** use one of the 42 possible $\langle c, o \rangle$ values for the Coding Function and Optical Interface Function shown in Table 12:

Coding Function $\langle c \rangle$	Optical Interface Function $\langle o \rangle$
STM-1 ITU-T G.707 [15] framer, N=1	ITU-T G.957 [21] I-1
	ITU-T G.957 [21] S-1.1
	ITU-T G.957 [21] S-1.2
	ITU-T G.957 [21] L-1.1
	ITU-T G.957 [21] L-1.2
	ITU-T G.957 [21] L-1.3
STM-4 ITU-T G.707 [15] framer, N=4	ITU-T G.957 [21] I-4
	ITU-T G.957 [21] S-4.1
	ITU-T G.957 [21] S-4.2
	ITU-T G.957 [21] L-4.1
	ITU-T G.957 [21] L-4.2
	ITU-T G.957 [21] L-4.3
STM-16 ITU-T G.707 [15] framer, N=16	ITU-T G.957 [21] I-16
	ITU-T G.957 [21] S-16.1
	ITU-T G.957 [21] S-16.2
	ITU-T G.957 [21] L-16.1
	ITU-T G.957 [21] L-16.2
	ITU-T G.957 [21] L-16.3
STM-64 ITU-T G.707 [15] framer, N=64	ITU-T G.691 [12] I-64.lr
	ITU-T G.691 [12] I-64.1
	ITU-T G.691 [12] I-64.2r
	ITU-T G.691 [12] I-64.2
	ITU-T G.691 [12] I-64.3
	ITU-T G.691 [12] I-64.5
	ITU-T G.691 [12] S-64.1
	ITU-T G.691 [12] S-64.2
	ITU-T G.691 [12] S-64.3
	ITU-T G.691 [12] S-64.5
	ITU-T G.691 [12] L-64.1
	ITU-T G.691 [12] L-64.2
	ITU-T G.691 [12] L-64.3
STM-256 ITU-T G.707 [15] framer, N=256	ITU-T G.693 [13] VSR2000-3R1
	ITU-T G.693 [13] VSR2000-3R2
	ITU-T G.693 [13] VSR2000-3R3
	ITU-T G.693 [13] VSR2000-3R5
	ITU-T G.693 [13] VSR2000-3M1
	ITU-T G.693 [13] VSR2000-3M2
	ITU-T G.693 [13] VSR2000-3M3
	ITU-T G.693 [13] VSR2000-3M5
	ITU-T G.693 [13] VSR2000-3H2

Coding Function $\langle c \rangle$	Optical Interface Function $\langle o \rangle$
	ITU-T G.693 [13] VSR2000-3H3
	ITU-T G.693 [13] VSR2000-3H5

Table 12 – SDH Physical Port $\langle c, o \rangle$ Values

Note that each Coding Function reference and Optical Interface Function reference includes the bit rate.

For example, if the value of the Client Protocol $\langle p \rangle$ is *SDH*, then $\langle c, o \rangle$ could be $\langle STM-64 ITU-T G.707 framer N=64, ITU-T G.691 L-64.1 \rangle$.

Another example of $\langle c, o \rangle$ for an *SDH* Client Protocol is $\langle STM-64 ITU-T G.707 framer N=64, ITU-T G.691 S-64.3 \rangle$.

- [R21]** When p has the value *SONET*, the 3-tuple $\langle SONET, c, o \rangle$ **MUST** use one of the 49 possible $\langle c, o \rangle$ values for the Coding Function and Optical Interface Function shown in Table 13:

Coding Function $\langle c \rangle$	Optical Interface Function $\langle o \rangle$ (1)
OC-3 GR-253-CORE [28] framer, N=3	SR-1
	IR-1
	IR-2
	LR-1
	LR-2
	LR-3
OC-12 GR-253-CORE [28] framer, N=12	SR-1
	IR-1
	IR-2
	LR-1
	LR-2
	LR-3
	VR-1
	VR-2
	VR-3
	UR-2
UR-3	
OC-48 GR-253-CORE [28] framer, N=48	SR-1
	IR-1
	IR-2
	LR-1
	LR-2
	LR-3
	VR-2
	VR-3
UR-2	

Coding Function $\langle c \rangle$	Optical Interface Function $\langle o \rangle$ (1)
OC-192 GR-253-CORE [28] framer, N=192	UR-3
	SR-1
	SR-2
	IR-1
	IR-2
	IR-3
	LR-1
	LR-2
	LR-2a
	LR-2b
	LR-2c
	LR-3
	VR-2a
	VR-2b
VR-3	
OC-768 GR-253-CORE [28] framer, N=768	SR-1
	SR-2
	IR-1
	IR-2
	IR-3
	LR-1
	LR-2
LR-3	

(1) The reference for all the listed values of $\langle o \rangle$ is GR-253-CORE clause 4.1 [28]

Table 13 – SONET Physical Port $\langle c, o \rangle$ Values

Note that each Coding Function reference and Optical Interface Function reference includes the bit rate.

For example, if the value of the Client Protocol $\langle p \rangle$ is *SONET*, then $\langle c, o \rangle$ could be $\langle OC-192 GR-253-CORE \text{ framer } N=192, GR-253-CORE \text{ clause } 4.1 LR-2b \rangle$.

Another example of $\langle c, o \rangle$ for a *SONET* Client Protocol is $\langle OC-192 GR-253-CORE \text{ framer } N=192, GR-253-CORE \text{ clause } 4.1 IR-3 \rangle$.

The following general requirement applies:

[R22] The Physical Layer **MUST** operate in full duplex mode.

Note that it is the responsibility of the Service Provider to ensure that requirements [R12] and [R13] from MEF 63 [26] are met.

8.4 Operator L1VC Service Attributes

An Operator L1VC is an association of two Operator L1VC End Points. An Operator L1VC End Point represents the logical attachment of an Operator L1VC to an EI. Only a single Operator L1VC End Point can be associated with a UNI, but multiple Operator L1VC End Points can be associated with an ENNI.

The following requirements constrain how L1CIs can be exchanged between EIs.

- [R23] If the egress L1CI mapped to an Operator L1VC End Point results from ingress L1CI mapped to an Operator L1VC End Point, there **MUST** be an Operator L1VC that associates the two Operator L1VC End Points.
- [R24] If the egress L1CI mapped to an Operator L1VC End Point results from ingress L1CI mapped to an Operator L1VC End Point, the two Operator L1VC End Points **MUST** be different from each other.
- [R25] Except in cases of detected errors or faults, the L1CI **MUST** be transported bit identical from the ingress EI to the egress EI at the same frequency (aka timing transparent).

Note that [R25] is a description of the ideal service. The L1CIs that are intended to be delivered might be replaced due to detected errors or faults. See the Operator L1VC Service Level Specification (Section 8.4.3).

An Operator L1VC always supports point-to-point, bi-directional (full duplex) transmission of L1CIs. That is, each Operator L1VC End Point associated by the Operator L1VC always supports ingress and egress L1CIs for that Operator L1VC. See Figure 14 and Figure 15 for examples of Operator Access and Operator Transit L1VCs.

8.4.1 Operator L1VC Identifier Service Attribute

The value of the Operator L1VC Identifier Service Attribute is a string that is used to allow the SP/SO and Operator to uniquely identify an Operator L1VC.

- [R26] The value of the Operator L1VC Identifier Service Attribute **MUST** be unique among all such identifiers for Operator L1VCs supported by the Operator Network.
- [R27] The value of the Operator L1VC Identifier Service Attribute **MUST** contain no more than 45 characters.⁹
- [R28] The value of the Operator L1VC Identifier Service Attribute **MUST** be a non-null RFC 2579 [10] DisplayString but not contain the characters 0x00 through 0x1f.

⁹ The limit of 45 characters is intended to establish limits on field lengths in existing or future protocols that will carry the identifier.

Note that the value of the Subscriber L1VC Identifier Service Attribute described in MEF 63 [26] is known to the Subscriber and Service Provider. Whether the value of the Subscriber L1VC Identifier Service Attribute is made known to the Operators is up to the Service Provider. Similarly, whether the value of the Operator L1VC Identifier Service Attribute is made known to the Subscriber is also up to the Service Provider.

8.4.2 Operator L1VC End Point List Service Attribute

The value of the Operator L1VC End Point List Service Attribute is a list of two Operator L1VC End Point Identifier Service Attribute values (Section 8.5.1), one for each Operator L1VC End Point associated by the Operator L1VC.

[R29] The values of the Operator L1VC End Point Identifiers in the Operator L1VC End Point List **MUST** be different.

Note that when the Operator L1VC End Points in the value of the Operator L1VC End Point List Service Attribute are at the same ENNI, the Operator Transit L1VC is said to provide Hairpin Connectivity (see Appendix C).

8.4.3 Operator L1VC Service Level Specification Service Attribute

The Operator L1VC Service Level Specification (SLS) Service Attribute is the technical specification of aspects of the service performance agreed to by the SP/SO and the Operator. For any given SLS, a given Performance Metric may or may not be specified.

The value of the Operator L1VC SLS Service Attribute is either *None* or a 3-tuple of the form $\langle t_s, T, PM \rangle$ where:

- t_s is a time that represents the date and time for the start of the SLS.

[R30] t_s **MUST** be specified to the nearest second.

- T is a duration that is used in conjunction with t_s to specify a contiguous sequence of time intervals for determining when performance objectives are met. The units for T are not constrained. For example, a calendar month is an allowable value. Since the duration of a month varies it could be specified as, e.g. from midnight on the 10th of one month up to but not including midnight on the 10th of the following month.

[R31] T **MUST** contain an integer number of seconds.

- PM is a non-empty list where each element in the list consists of a Performance Metric Name, a list of parameter values specific to the definition of the Performance Metric, and Performance Metric Objective.

A Performance Metric is a quantitative characterization of L1CI delivery quality experienced by the SP/SO. Methods for the SP/SO and the Operator to monitor the Operator L1VC performance to estimate this delivery quality are beyond the scope of this Standard. This section specifies the following Performance Metrics:

1. The One-way Delay Performance Metric (Section 8.4.3.3),
2. The One-way Errored Second Performance Metric (Section 8.4.3.4),
3. The One-way Severely Errored Second Performance Metric (Section 8.4.3.5),
4. The One-way Unavailable Second Performance Metric (Section 8.4.3.6), and
5. The One-way Availability Performance Metric (Section 8.4.3.7).

These are similar to the Performance Metrics for a Subscriber L1VC described in MEF 63 [26] but are more general because they apply to both the client protocol L1CI of an Operator Access L1VC and the ODU L1CI of an Operator Transit L1VC (Section 7.4). For brevity the term L1CI is used to refer to both the client protocol L1CI and the ODU L1CI.

[R32] If *PM* contains an entry with a given Performance Metric Name, then the entry **MUST** specify the related parameter values and the Performance Objective for that Performance Metric.

An example of an Operator L1VC SLS Service Attribute (3-tuple) is shown in Table 14.

Operator L1VC Service Level Specification	
Tuple Entry	Value
t_s	2017-07-01, 08:00:00 UTC
T	one calendar month
PM	One-way Availability Performance Metric
	Ordered Operator L1VC End Point pair $\langle U1, U2 \rangle$
	$\hat{A} = 99.99\%$

Table 14 – Example of an Operator L1VC SLS with One Performance Metric

PM can contain multiple entries with a given Performance Metric Name, but one or more of the parameter values associated with each objective for a given Performance Metric Name need to be different from each other. For example, *PM* could contain two objectives for the One-way Delay Performance Metric, each corresponding to a different value of the percentile P_d (see Section 8.4.3.3).

[D2] The Operator **SHOULD** support an SLS with a value not equal to *None*.

[D3] The Operator **SHOULD** support an SLS where the *PM* has separate entries with the same Performance Metric Name for each ordered Operator L1VC End Point pair in the value of the Operator L1VC End Point List Service Attribute.

For example, given an Operator L1VC End Point List Service Attribute value = $\langle A, B \rangle$, the One-way Delay Performance Metric Objective for ordered Operator L1VC End Point pair $\langle A, B \rangle$ could be different than the One-way Delay Performance Metric Objective for ordered Operator L1VC End Point pair $\langle B, A \rangle$ when the connectivity is provided over a uni-directional ring.

8.4.3.1 Basic Time Constructs

For the SLS, the sequence $\{T_l, l = 0,1,2, \dots\}$ is used where¹⁰

$$T_l = [t_s + lT, t_s + (l + 1)T)$$

Each element of the sequence $\{T_l\}$, referred to as an interval T_l , is used for assessing the success of the Operator L1VC in meeting the Performance Metric Objectives of the SLS. Note that an interval T_l has a date and time for its start and end, whereas T is simply a duration with no specified start and end time. Further, an interval T_l is specified with respect to the start of the SLS (i.e., t_s).

A sequence of seconds $\{\sigma_k, k = 0,1,2, \dots\}$ is defined where

$$\sigma_k = [t_s + k, t_s + k + 1)$$

A L1CI is considered to be in a σ_k second at an EI (e.g., to evaluate errored L1CI) when the last bit of that L1CI arrives at that EI within that σ_k second. Note that a L1CI could be in one σ_k second at the ingress EI and a different σ_k second at the egress EI (see Appendix D).

8.4.3.2 Hierarchy of Time

An SLS interval T_l is divided into three categories: Available Time, Unavailable Time (see the text following Figure 21) and Maintenance Interval Time (see the text following Figure 20). The SLS Performance Metric Objectives for the One-way Delay Performance Metric, One-way Errored Second Performance Metric and One-way Severely Errored Second Performance Metric only apply during Available Time.¹¹ Figure 19 illustrates the relationship between the three categories of time in an SLS interval T_l .¹²

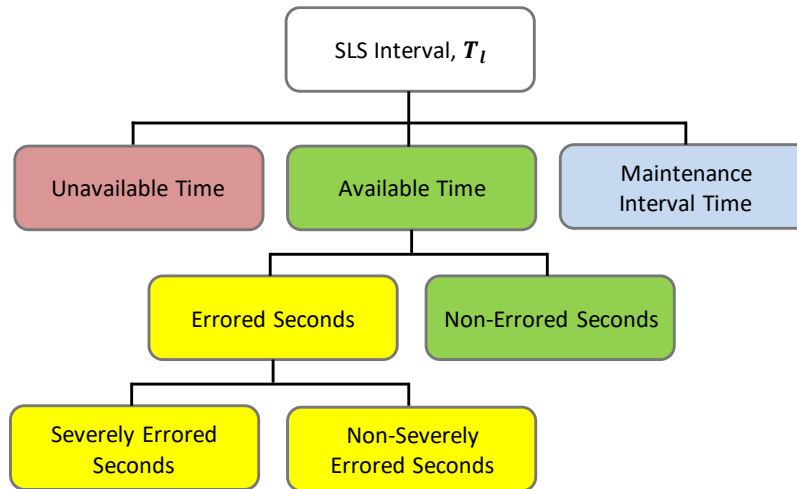

Figure 19 – Hierarchy of Time

¹⁰ A value is in the range $[X, Y)$ if $X \leq \text{value} < Y$. In other words, the range includes all the values from X up to but not including Y .

¹¹ This is consistent with Note 6 of Figure I.1 in G.8201 [24] Appendix I.

¹² Based on Figure 16 in MEF 10.4 [25].

For a given ordered Operator L1VC End Point pair $\langle i, j \rangle$ and a given T_l let

$$\text{Operator L1VC}_{SES}^{(i,j)}(\sigma_k) = E_{SES}^{(j)}(\sigma_k) - I_{SES}^{(i)}(\sigma_k)$$

Where $E_{SES}^{(j)}(\sigma_k)$ and $I_{SES}^{(i)}(\sigma_k)$ are defined in Section 8.4.3.5.¹³ Informally, *availability detected* occurs following ten consecutive seconds when

$$\text{Operator L1VC}_{SES}^{(i,j)}(\sigma_k) \leq 0$$

For a given second σ_k , the set of egress L1CI will be different than the set of ingress L1CI due to the transit delay (e.g., approximately 5ms for 1000km of fibre), which may result in a negative value for the above formula. Informally, *unavailability detected* occurs following ten consecutive seconds when

$$\text{Operator L1VC}_{SES}^{(i,j)}(\sigma_k) = 1$$

Figure 20 illustrates an example of the detection of unavailability and availability.¹⁴ Each SES (gray square) in Figure 20 indicates that the value of $\text{Operator L1VC}_{SES}^{(i,j)}(\sigma_k) = 1$ for that second. Each ES (crossed square) or error-free second (clear square) indicates that the value of $\text{Operator L1VC}_{SES}^{(i,j)}(\sigma_k) \leq 0$ for that second. Note that the ten consecutive seconds detection interval shifts by one second increments, referred to as a sliding window.

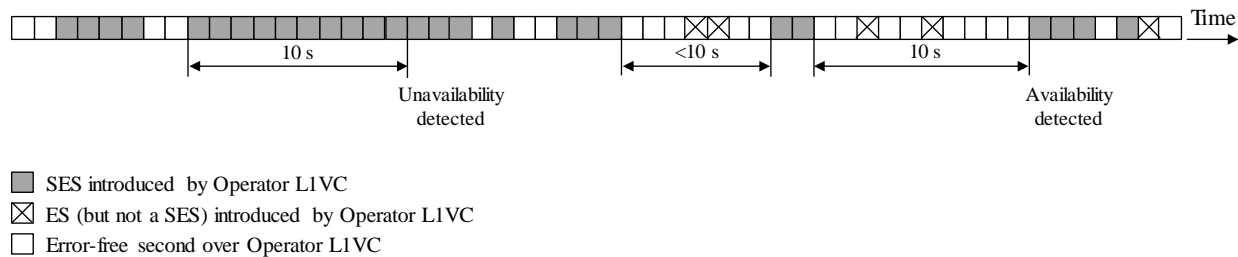

Figure 20 – Example of Detection of Unavailability and Availability

Maintenance Interval Time (MIT) for $\langle i, j \rangle$, $MIT(i, j)$, is defined as the set of σ_k 's within T_l agreed to by the SP/SO and Operator during which the Operator L1VC may not perform well or at all. Examples of a Maintenance Interval include:¹⁵

- An interval during which the Operator may disable the Operator L1VC for network maintenance such as equipment replacement.
- An interval during which the SP/SO and Operator may perform joint fault isolation testing.

¹³ The value of $\text{Operator L1VC}_{SES}^{(i,j)}(\sigma_k)$ can be approximated by the Operator for an Access or Transit L1VC using ODU tandem connection monitoring in G.709 [16]. However, measurement techniques are beyond the scope of this Standard.

¹⁴ This figure is based on Figure A.1 in G.8201[24] Annex A.

¹⁵ This is consistent with G.7710 [23] clause 10.1.2.

- An interval during which the Operator makes SP/SO requested changes and making such changes may disrupt the Operator L1VC.

The sliding window of ten seconds used to detect availability or unavailability operates independently of MIT. Consequently, a period of Unavailable Time (UAT) or Available Time (AT) (defined formally below, including $U(i, j)$ and $A(i, j)$) of less than ten seconds could be entered prior to a Maintenance Interval. Similarly, a period of AT or UAT could be entered immediately following a Maintenance Interval. Figure 21 illustrates an example of a Maintenance Interval. Each SES (gray square) in Figure 21 indicates that the value of $Operator\ L1VC_{SES}^{(i,j)}(\sigma_k) = 1$ for that second. Each ES (crossed square) or error-free second (clear square) indicates that the value of $Operator\ L1VC_{SES}^{(i,j)}(\sigma_k) \leq 0$ for that second. Note that the consecutive SES introduced by the Operator L1VC resulting in the detection of UAT are Unavailable Seconds (UAS) and do not contribute towards the One-way Severely Errored Second Performance Metric.

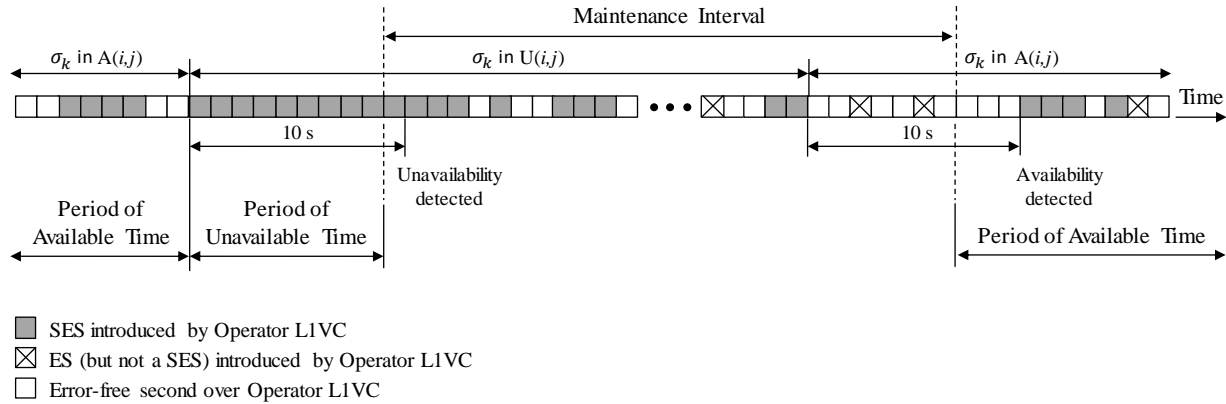

Figure 21 – Example of a Maintenance Interval

The formal definitions of AT and UAT follow.¹⁶ Each $\sigma_k, k = 0, 1, 2, \dots$ belongs to one of two sets; $A(i, j)$ or $U(i, j)$. The membership is determined by the following two expressions:

$$\sigma_0 \in A(i, j)$$

For $k = 1, 2, \dots$

$$\sigma_k \in \begin{cases} A(i, j) & \text{if } \sigma_{k-1} \in A(i, j) \text{ and there exists } m \in \{k, k+1, \dots, k+9\} \text{ such that } Operator\ L1VC_{SES}^{(i,j)}(\sigma_m) \leq 0 \\ U(i, j) & \text{if } \sigma_{k-1} \in A(i, j) \text{ and } Operator\ L1VC_{SES}^{(i,j)}(\sigma_m) = 1 \text{ for } m = k, k+1, \dots, k+9 \\ U(i, j) & \text{if } \sigma_{k-1} \in U(i, j) \text{ and there exists } m \in \{k, k+1, \dots, k+9\} \text{ such that } Operator\ L1VC_{SES}^{(i,j)}(\sigma_m) = 1 \\ A(i, j) & \text{if } \sigma_{k-1} \in U(i, j) \text{ and } Operator\ L1VC_{SES}^{(i,j)}(\sigma_m) \leq 0 \text{ for } m = k, k+1, \dots, k+9 \end{cases}$$

Then Available Time for $\langle i, j \rangle$ and T_l is defined as

$$AT(i, j, T_l) = \{\sigma_k, k = 0, 1, \dots \mid \sigma_k \in A(i, j), \sigma_k \subseteq T_l, \sigma_k \notin MIT(i, j)\}$$

¹⁶ Note these definitions of Available Time and Unavailable Time are different than the Available Time and Unavailable Time defined in G.7710 [23] Table 25 which do not explicitly state that MIT is excluded from the calculation of Available Time and Unavailable Time.

and Unavailable Time for $\langle i, j \rangle$ and T_l is defined as

$$UAT(i, j, T_l) = \{\sigma_k, k = 0, 1, \dots \mid \sigma_k \in U(i, j), \sigma_k \subseteq T_l, \sigma_k \notin MIT(i, j)\}$$

8.4.3.3 One-way Delay Performance Metric

The One-way Delay¹⁷ for the L1CI that ingresses at EI₁ and that egresses at EI₂ is defined as the time elapsed from the reception of the first bit of the ingress L1CI at EI₁ until the reception of that first bit of the corresponding L1CI egressing at EI₂.¹⁸ This definition is illustrated in Figure 22.

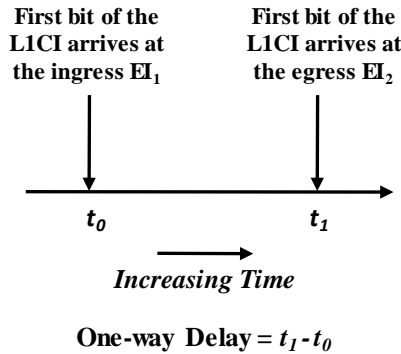

Figure 22 – One-way Delay for L1CI

For a given ordered Operator L1VC End Point pair, denoted $\langle i, j \rangle$, and a given T_l , let $\tilde{D}(\langle i, j \rangle, T_l)$ be the set of all One-way delays for L1CIs that ingress at the EI where i is located during Available Time. Note that $\tilde{D}(\langle i, j \rangle, T_l)$ can be empty, e.g., when $AT(i, j, T_l) = \emptyset$ (i.e., is empty). Let P_d be a percentage in $(0, 100]$.

[R33] The SLS **MUST** define the One-way Delay Performance Metric, denoted $\bar{D}(\langle i, j \rangle, T_l)$ as

$$\bar{D}(\langle i, j \rangle, T_l) = \begin{cases} 0 & \text{if } \tilde{D}(\langle i, j \rangle, T_l) = \emptyset \\ P_d\text{-percentile of the values in } \tilde{D}(\langle i, j \rangle, T_l) & \text{otherwise} \end{cases}$$

Table 15 shows what is contained in a *PM* entry for the One-way Delay Performance Metric.

Item	Value
Performance Metric Name	One-way Delay Performance Metric
$\langle i, j \rangle$	Ordered pair of Operator L1VC End Points
P_d	A percentage in $(0, 100]$
\hat{D}	Performance Metric Objective in time units > 0

Table 15 – *PM* Entry for the One-way Delay Performance Metric

¹⁷ One-way delay is difficult to measure and therefore one-way delay may be approximated from two-way measurements. However, measurement techniques are beyond the scope of this Standard.

¹⁸ This definition is consistent with G.7710 [23] clause 10.1.2.

- [R34]** The SLS **MUST** define the One-way Delay Performance Metric Objective as met during Available Time over T_l for a PM entry of the form in Table 15 if and only if $\bar{D}((i, j), T_l) \leq \widehat{D}$.

Recall that for any given SLS, a given Performance Metric may or may not be specified (see Section 8.4.3).

Note that two One-way Delay Performance Metric Objectives \widehat{D}_1 and \widehat{D}_2 could be specified with corresponding parameters P_{d1} and P_{d2} respectively, where $P_{d2} > P_{d1}$ (\widehat{D}_2 being a longer delay objective associated with a higher percentile P_{d2} (e.g., 100th) to bound potentially longer delays following a protection switch).

Note that an ENNI demarcation is a point, such that the time of the first bit of a given L1CI to egress one Operator's network at an ENNI is also the time of the first bit of the same L1CI to ingress the adjacent Operator's network – there is zero delay across an ENNI.

8.4.3.4 One-way Errored Second Performance Metric

An errored second (ES) is defined as one second σ_k in Available Time with at least one errored block (EB)¹⁹ and is not a SES (see Section 8.4.3.5). An EB is defined as a block in which one or more bits are in error following Forward Error Correction.²⁰ In this specification the L1CI corresponds to a block. The definition of an errored client protocol L1CI for each category of client protocol is listed in Table 16.

¹⁹ This definition is consistent with G.8201 [24] Annex A and G.7710 [23] clause 10.1.2.

²⁰ This definition is consistent with G.8201 [24] clauses 3.1.1 and 3.2 and G.7710 [23] clause 10.1.2.

Client Protocol / Physical Port	Coding	Errored Client Protocol L1CI Definition (1)
Ethernet		
GigE	8B/10B	An invalid code-group as defined in clause 36.2.4.6 in IEEE Std 802.3 [8]
10GigE WAN	Scrambled	A Section BIP-8 anomaly/error as defined in clause 50.3.2.5 in IEEE Std 802.3 [8]
10GigE LAN	64B/66B	An invalid block as defined in Clause 49.2.4.6 in IEEE Std 802.3 [8]
40GigE	64B/66B	An invalid block as defined in clause 82.2.3.5 in IEEE Std 802.3 [8]
100GigE	64B/66B	
Fibre Channel		
FC-100	8B/10B	A code violation as defined in Clause 5.3.3.3 in FC-FS-2 [3]
FC-200	8B/10B	
FC-400	8B/10B	
FC-800	8B/10B	
FC-1200	64B/66B	Clause 13 in FC-10GFC [1] points to IEEE Std 802.3 [8]
FC-1600	64B/66B	A code violation as defined in clause 5.3 in FC-FS-3 [4]
FC-3200	64B/66B	A code violation as defined in clause 5.3 in FC-FS-4 [6]
SDH		
STM-1	Scrambled	A Regenerator Section B1 error and errored block as defined in clause 10.2.1.2 in ITU-T G.783 [17]
STM-4	Scrambled	
STM-16	Scrambled	
STM-64	Scrambled	
STM-256	Scrambled	
SONET		
OC-3	Scrambled	Section B1 error monitoring as defined in clause 3.3.2.1 in Telcordia GR-253-CORE [28]
OC-12	Scrambled	
OC-48	Scrambled	
OC-192	Scrambled	
OC-768	Scrambled	

(1) The error detection capability of the coding functions varies.

Table 16 – Errored Client Protocol L1CI Definition

The definition of an errored ODU L1CI is listed in Table 17.

ODUk	Coding	Errored ODU L1CI Definition
0	Scrambled	An ODUk path BIP-8 error and errored block as defined in clause 8.3.4.2 in ITU-T G.798 [18]
1	Scrambled	
flex	Scrambled	
2	Scrambled	
2e	Scrambled	
3	Scrambled	
4	Scrambled	

Table 17 – Errored ODU L1CI Definition

Per [R25], an ES at the ingress EI will typically result in an ES at the egress EI. To quantify the performance of the Operator L1VC the One-way Errored Second Performance Metric is defined as the difference between egress ES and ingress ES.

[R35] For a given ordered Operator L1VC End Point pair $\langle i, j \rangle$ and a given T_l , the SLS **MUST** define the One-way Errored Second Performance Metric as follows:

- Let $I_{ES}^{(i)}(\sigma_k) = \begin{cases} 1 & \text{if } \sigma_k \text{ is an Errored Second} \\ 0 & \text{otherwise} \end{cases}$

denote whether there is an ingress ES during one second σ_k of Available Time in T_l at the EI where Operator L1VC End Point i is located.

- Let $E_{ES}^{(j)}(\sigma_k) = \begin{cases} 1 & \text{if } \sigma_k \text{ is an Errored Second} \\ 0 & \text{otherwise} \end{cases}$

denote whether there is an egress ES during the same one second σ_k of Available Time in T_l at the EI where Operator L1VC End Point j is located.

- Then the One-way Errored Second Performance Metric **MUST** be defined as:

$$\sum_{\sigma_k \subseteq AT(i, j, T_l)} \left(E_{ES}^{(j)}(\sigma_k) - I_{ES}^{(i)}(\sigma_k) \right)$$

The value of the One-way Errored Second Performance Metric is represented by the symbol *Errored Second PM*.

For a given second σ_k of Available Time, the set of egress L1CI will be different than the set of ingress L1CI due to the transit delay (e.g., approximately 5ms for 1000km of fibre). However, the net effect on an *Errored Second PM* is expected to be negligible.

Table 18 shows what is contained in a *PM* entry for the One-way Errored Second Performance Metric.

Item	Value
Performance Metric Name	One-way Errored Second Performance Metric
$\langle i, j \rangle$	Ordered pair of Operator L1VC End Points
\widehat{ES}	Performance Metric Objective expressed as an integer ≥ 0

Table 18 – PM Entry for the One-way Errored Second Performance Metric

[R36] The SLS **MUST** define the One-way Errored Second Performance Metric Objective as met during Available Time over T_l for a PM entry of the form in Table 18 if and only if *Errored Second PM* $\leq \widehat{ES}$.

Recall that for any given SLS, a given Performance Metric may or may not be specified (see Section 8.4.3).

8.4.3.5 One-way Severely Errored Second Performance Metric

A Severely Errored Second (SES) is defined as:

- One second σ_k which contains $\geq 15\%$ errored L1CI²¹, where an errored L1CI is defined in Section 8.4.3.4, or
- One second σ_k which contains a defect (e.g., loss of signal)²².

A defect may occur on ingress to an Operator’s network or within the Operator’s network and may result in the insertion of a replacement signal (transport technology specific). Note that a replacement signal itself represents a defect.

Note that a SES is not counted as an ES (see Section 8.4.3.4).

For example, if the Operator Access L1 Service is provided by an OTN network, the client protocol defect, transport defect and replacement signal reference for each category of client protocol are listed in Table 19.

²¹ This definition is consistent with G.8201 [24] clause 3.1.2.

²² This definition is consistent with G.8201 [24] clause 7.1.2 and G.7710 [23] clause 10.1.2.

Client Protocol / Physical Port	Defects and Replacement signal Clause reference in G.709 [16]
Ethernet	
GigE	17.7.1
10GigE WAN	17.2
10GigE LAN	17.2
40GigE	17.7.4
100GigE	17.7.5
Fibre Channel	
FC-100	17.7.1
FC-200	17.7.2
FC-400	17.9.1
FC-800	17.9.1
FC-1200	17.8.2
FC-1600	17.9.2
FC-3200	17.9.3
SDH	
STM-1	17.7.1
STM-4	17.7.1
STM-16	17.2
STM-64	17.2
STM-256	17.2
SONET	
OC-3	17.7.1
OC-12	17.7.1
OC-48	17.2
OC-192	17.2
OC-768	17.2

Table 19 – Defects and Replacement Signal per Client Protocol in OTN

As another example, if the Operator Transit L1 Service is provided by an OTN network, the server defect detection (OTUk) and replacement signal (ODU-AIS) references are listed in Table 20.

Function	Definition	Reference
Server defect detection and replacement signal insertion	OTU/ODU Adaptation Sink	G.798 Section 13.3.1.2 [18]
	ODU-AIS replacement signal	G.709 Section 16.5.1 [16]

Table 20 – Server Defect Detection and Replacement Signal for ODUk

Per [R25], a SES at the ingress EI will typically result in a SES at the egress EI. To quantify the performance of the Operator L1VC the One-way Severely Errored Second Performance Metric is defined as the difference between egress SES and ingress SES.

- [R37] For a given ordered Operator L1VC End Point pair $\langle i, j \rangle$ and a given T_l , the SLS **MUST** define the One-way Severely Errored Second Performance Metric as follows:

- Let $I_{SES}^{(i)}(\sigma_k) = \begin{cases} 1 & \text{if } \sigma_k \text{ is a Severely Errored Second} \\ 0 & \text{otherwise} \end{cases}$
denote whether there is an ingress SES during one second σ_k within T_l at the EI where Operator L1VC End Point i is located.
- Let $E_{SES}^{(j)}(\sigma_k) = \begin{cases} 1 & \text{if } \sigma_k \text{ is a Severely Errored Second} \\ 0 & \text{otherwise} \end{cases}$
denote whether there is an egress SES during the same one second σ_k within T_l at the EI where Operator L1VC End Point j is located.
- Then the One-way Severely Errored Second Performance Metric **MUST** be defined as:

$$\sum_{\sigma_k \in AT(i,j,T_l)} \left(E_{SES}^{(j)}(\sigma_k) - I_{SES}^{(i)}(\sigma_k) \right)$$

The value of the One-way Severely Errored Second Performance Metric is represented by the symbol *Severely Errored Second PM*.

For a given second σ_k of Available Time, the set of egress L1CI will be different than the set of ingress L1CI due to the transit delay (e.g., approximately 5ms for 1000km of fibre). However, the net effect on a *Severely Errored Second PM* is expected to be negligible.

Table 21 shows what is contained in a *PM* entry for the One-way Severely Errored Second Performance Metric.

Item	Value
Performance Metric Name	One-way Severely Errored Second Performance Metric
$\langle i, j \rangle$	Ordered pair of Operator L1VC End Points
\widehat{SES}	Performance Metric Objective expressed as an integer ≥ 0

Table 21 – *PM* Entry for the One-way Severely Errored Second Performance Metric

- [R38]** The SLS **MUST** define the One-way Severely Errored Second Performance Metric Objective as met during Available Time over T_l for a *PM* entry of the form in Table 21 if and only if *Severely Errored Second PM* $\leq \widehat{SES}$.

Recall that for any given SLS, a given Performance Metric may or may not be specified (see Section 8.4.3).

8.4.3.6 *One-way Unavailable Second Performance Metric*

An Unavailable Second (UAS) is defined as a second during Unavailable Time (UAT) (Section 8.4.3.2).

- [R39] For a given ordered Operator L1VC End Point pair and a given T_l , the SLS **MUST** define the One-way Unavailable Second Performance Metric as the total number of UAS for the ordered Operator L1VC End Point pair over T_l .

The value of the One-way Unavailable Second Performance Metric is represented by the symbol *Unavailable Seconds PM*.

Table 22 shows what is contained in a *PM* entry for the One-way Unavailable Second Performance Metric.

Item	Value
Performance Metric Name	One-way Unavailable Second Performance Metric
$\langle i, j \rangle$	Ordered pair of Operator L1VC End Points
\overline{UAS}	Performance Metric Objective expressed as an integer ≥ 0

Table 22 – *PM* Entry for the One-way Unavailable Second Performance Metric

- [R40] The SLS **MUST** define the One-way Unavailable Second Performance Metric Objective as met over T_l for a *PM* entry of the form in Table 22 if and only if *Unavailable Seconds PM* $\leq \overline{UAS}$.

Recall that for any given SLS, a given Performance Metric may or may not be specified (see Section 8.4.3).

8.4.3.7 One-way Availability Performance Metric

Availability is defined as the number of seconds of Available Time divided by the sum of the number of seconds of Available Time plus the number of seconds of Unavailable Time expressed as a percentage over a given interval T_l (Section 8.4.3.2).²³

- [R41] For a given ordered Operator L1VC End Point pair and a given T_l , the SLS **MUST** define the One-way Availability Performance Metric for the ordered Operator L1VC End Point pair over the time interval T_l as:

$$\frac{|AT(i, j, T_l)|}{|AT(i, j, T_l)| + |UAT(i, j, T_l)|} \times 100\%$$

when $(|AT(i, j, T_l)| + |UAT(i, j, T_l)|) > 0$ and 100% otherwise

where the vertical bars around each set indicate the number of elements in the set.

The value of the One-way Availability Performance Metric is represented by the symbol *Availability PM*.

²³ Note this definition of Available Time is different than the Available Time defined in G.7710 [23] Table 25 which does not explicitly state that MIT is excluded from the calculation of Available Time.

For example, for $|AT(i, j, T_l)| = 2,591,974$ and $|UAT(i, j, T_l)| = 26$, then the *Availability PM* is 99.999%.

Table 23 shows what is contained in a *PM* entry for the One-way Availability Performance Metric.

Item	Value
Performance Metric Name	One-way Availability Performance Metric
$\langle i, j \rangle$	Ordered pair of Operator L1VC End Points
\hat{A}	Performance Metric Objective expressed as a percentage > 0

Table 23 – *PM* Entry for the One-way Availability Performance Metric

- [R42] The SLS **MUST** define the One-way Availability Performance Metric Objective as met over T_l for a *PM* entry of the form in Table 23 if and only if *Availability PM* $\geq \hat{A}$.

Recall that for any given SLS, a given Performance Metric may or may not be specified (see Section 8.4.3).

8.5 Operator L1VC End Point Service Attributes

An Operator L1VC End Point is a logical entity at a given EI that is associated with L1CI passing over that EI. Per Section 8.4, an Operator L1VC is an association of two Operator L1VC End Points. An Operator L1VC End Point represents the logical attachment of an Operator L1VC to an EI.

8.5.1 Operator L1VC End Point Identifier Service Attribute

The value of the Operator L1VC End Point Identifier Service Attribute is a string that is used to allow the SP/SO and Operator to uniquely identify the Operator L1VC End Point.

- [R43] The value of the Operator L1VC End Point Identifier **MUST** be unique among all such identifiers for Operator L1VC End Points supported by the Operator network.
- [R44] The value of the Operator L1VC End Point Identifier **MUST** contain no more than 45 characters.²⁴
- [R45] The value of the Operator L1VC End Point Identifier **MUST** be a non-null RFC 2579 [10] Display String but not contain the characters 0x00 through 0x1f.

8.5.2 Operator L1VC End Point External Interface Type Service Attribute

The value of the Operator L1VC End Point External Interface Type Service Attribute is either *UNI* or *ENNI*.

²⁴ The limit of 45 characters is intended to establish limits on field lengths in existing or future protocols that will carry the identifier.

8.5.3 Operator L1VC End Point External Interface Identifier Service Attribute

The value of the Operator L1VC End Point External Interface Identifier Service Attribute is either an Operator ENNI Identifier Service Attribute value per Section 8.2.1 or an Operator UNI Identifier Service Attribute value per Section 8.3.1.

[R46] If the value of the Operator L1VC End Point External Interface Type Service Attribute is *ENNI*, then the value of the Operator L1VC End Point External Interface Identifier Service Attribute **MUST** be an Operator ENNI Identifier Service Attribute value per Section 8.2.1.

[R47] If the value of the Operator L1VC End Point External Interface Type Service Attribute is *UNI*, then the value of the Operator L1VC End Point External Interface Identifier Service Attribute **MUST** be an Operator UNI Identifier Service Attribute value per Section 8.3.1.

The combination of the Operator L1VC End Point External Interface Type value (Section 8.5.2) and the Operator L1VC End Point External Interface Identifier value serve to specify a specific EI. The Operator L1VC End Point is said to be at this EI.

8.5.4 Operator L1VC End Point Map Service Attribute

The value of the Operator L1VC End Point Map Service Attribute is either *Not Applicable* or a non-empty list of 2-tuples of the form $\langle i, TS \rangle$.

[R48] The value of the Operator L1VC End Point Map Service Attribute **MUST** be *Not Applicable* if, and only if, the value of the Operator L1VC End Point Interface Type Service Attribute is *UNI*.

In the 2-tuple $\langle i, TS \rangle$, where $i \in \{1, 2, \dots, k\}$ and k is specified in the value of the ENNI List of Physical Layers Common Attribute (Section 8.1.2) for the ENNI identified by the value of the Operator L1VC End Point External Interface Identifier Service Attribute (Section 8.5.3) and TS is either:

- A specification of the Tributary Slots occupied in a HO ODU_i of the form $n\{\text{list of integers}\}$ where $n = 1.25$ or 2.5 to indicate the nominal Tributary Slot rate in Gb/s [Table 7-9 in G.709 [16]] or
- *Null*.

The Operator L1VC End Point Map Service Attribute specifies which bits that cross the ENNI are mapped to and from the Operator L1VC End Point. $TS = \text{Null}$ indicates that all bits of the ODU crossing the ENNI are mapped to the Operator L1VC End Point and $i = k$.

[R49] The value of the Operator L1VC End Point Map Service Attribute **MUST** contain an entry with $i = k$.

Note that it is the responsibility of the SP/SO to ensure that the value of $\langle k, TS \rangle$ be used in the value of the proper Operator L1VC End Point Map Service Attribute in the peering Operator Network.

- [R50] The value of the Operator L1VC End Point Map Service Attribute **MUST** be such that each value of i is unique within the list of 2-tuples.

Referring to the Figure 23 example, consider the Operator C Access L1VC between UNI 1 and ENNI 1 which has an ENNI List of Physical Layers Common Attribute with an index $k = 4$ in the value of the entry $\langle c \rangle$. Suppose the SP and Operator C agree that the client protocol is FC-400, which is mapped into a LO ODUflex that is further multiplexed into a HO ODU2. The details of how LO ODUs are multiplexed into the Tributary Slots of HO ODUs are defined in clause 19 of G.709 [16]. Then the value of the Operator C L1VC End Point Map Service Attribute could be: $\langle 2, 1.25\{1,2,3,4\} \rangle$, $\langle 4, 1.25\{9,10,11,12,13,14,15,16\} \rangle$, where the LO ODUflex is multiplexed into Tributary Slots 1-4 of a HO ODU2, which is multiplexed into Tributary Slots 9-16 of the HO ODU4 exchanged at ENNI 1 (as indicated by the black ellipse, only the associated L1VC End Point is shown for clarity).

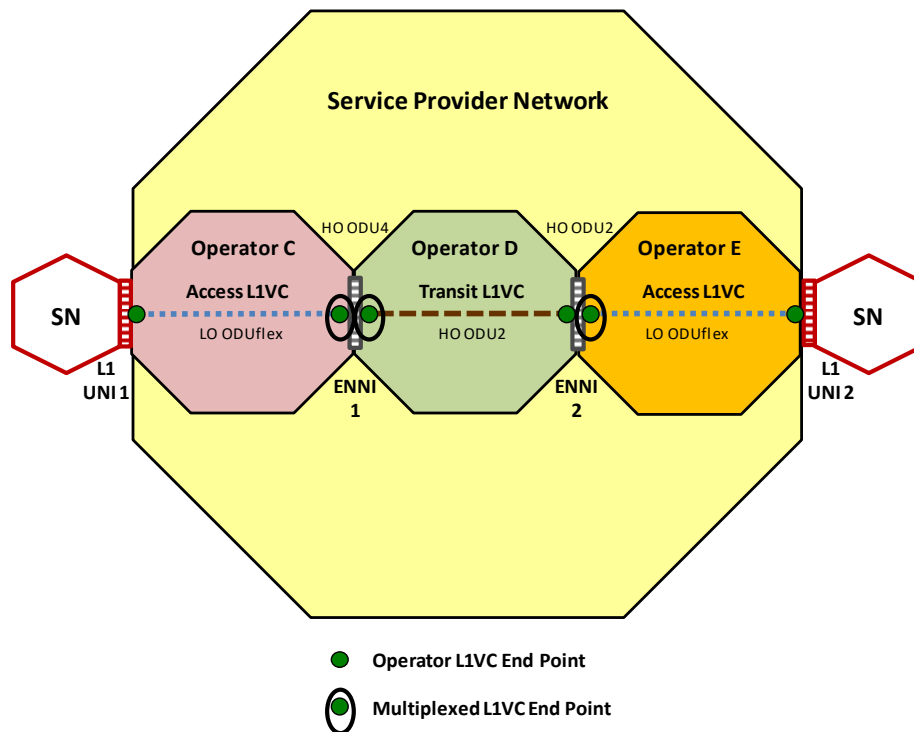

Figure 23 – Operator Access and Transit L1VCs Example

Continuing the example for the Operator D Transit L1VC, at the same ENNI 1 which has an ENNI List of Physical Layers Common Attribute with an index $k = 4$ in the value of the entry $\langle c \rangle$, the SP and Operator D agree on the value of the Operator D L1VC End Point Map Service Attribute to be: $\langle 4, 1.25\{9,10,11,12,13,14,15,16\} \rangle$. Operator D is responsible for transporting the HO ODU2 and has no need to know its structure, only the Tributary Slots it occupies in the HO ODU4 (indicated by the black ellipse, only the associated L1VC End Point is shown for clarity). At ENNI 2, which has an ENNI List of Physical Layers Common Attribute with an index $k = 2$ in the value

of the entry $\langle c \rangle$, the SP and Operator D agree on the value of the Operator D L1VC End Point Map Service Attribute to be: $\langle 2, Null \rangle$ (note there is no multiplexing by Operator D for delivering the HO ODU2 across ENNI 2, therefore the *Null* value and no black ellipse is in the figure).

For the Operator E Access L1VC between ENNI 2, which has an ENNI List of Physical Layers Common Attribute with an index $k = 2$ in the value of the entry $\langle c \rangle$, and UNI 2, the SP and Operator E agree on the value of the Operator E L1VC End Point Map Service Attribute to be: $\langle 2, 1.25\{1,2,3,4\} \rangle$, where the LO ODUflex can be demultiplexed from Tributary Slots 1-4 of the HO ODU2 (indicated by the black ellipse, only the associated L1VC End Point is shown for clarity) and delivered to UNI 2 where the FC-400 client protocol is demapped.

9 Operator Layer 1 Service Definitions and Requirements

The Operator L1 Service definitions in this Standard use the Service Attribute framework described in Section 6.1. Based on that framework, the four types of Service Attributes are used to define a given Operator L1 Service: ENNI (Section 8.2), Operator UNI (Section 8.3), Operator L1VC (Section 8.4) and Operator L1VC End Point (Section 8.5). Note that ENNI Common Attributes (Section 8.1) are, by definition, common to all Operator L1 Services with Operator L1VC End Points at the ENNI. This section does not impose any constraints on the values of the ENNI Common Attributes as specified in Section 8.1.

Section 9.1 provides the requirements for an Operator Access L1 Service and Section 9.2 provides the requirements for an Operator Transit L1 Service.

9.1 Operator Access Layer 1 Service Definition and Requirements

An Operator Access L1 Service is an Operator L1 Service that uses an Operator L1VC which associates one Operator L1VC End Point at a UNI and one Operator L1VC End Point at an ENNI; that is, where the Operator L1VC End Point List Service Attribute value contains one Operator L1VC End Point with an Operator L1VC End Point External Interface Type Service Attribute value of *UNI* and one with an Operator L1VC End Point External Interface Type Service Attribute value of *ENNI*.

Figure 9 illustrates several examples of an Operator Access L1 Service.

The Operator Access L1 Service definition is specified in terms of the Service Attributes in Section 8. The additional requirement below applies for the Operator L1VC End Point List Service Attribute (Section 8.4.2).

- [R51]** For an Operator Access L1 Service one of the Operator L1VC End Points in the value of the Operator L1VC End Point List Service Attribute **MUST** be at an ENNI and the other **MUST** be at a UNI.

9.2 Operator Transit Layer 1 Service Definition and Requirements

An Operator Transit L1 Service is an Operator L1 Service that uses one Operator L1VC which associates one Operator L1VC End Point at an ENNI and one Operator L1VC End Point at another ENNI; that is, where the Operator L1VC End Point List Service Attribute value contains two Operator L1VC End Points where both have an Operator L1VC End Point External Interface Type Service Attribute value of *ENNI*.

Figure 9 illustrates an example of an Operator Transit L1 Service.

The Operator Transit L1 Service definition is specified in terms of the Service Attributes in Section 8. The additional requirement below applies for the Operator L1VC End Point List Service Attribute (Section 8.4.2).

- [R52]** For an Operator Transit L1 Service both of the Operator L1VC End Points in the value of the Operator L1VC End Point List Service Attribute **MUST** be at ENNIs.

10 References

- [1] ANSI INCITS 364-2003, *Fibre Channel – 10 Gigabit (FC-10GFC)*, November 2003.
- [2] ANSI INCITS 404-2006, *Fibre Channel – Physical Interfaces – 2 (FC-PI-2)*, August 2006.
- [3] ANSI INCITS 424-2007[R2012], *Fibre Channel – Framing and Signaling – 2 (FC-FS-2)*, February 2007.
- [4] ANSI INCITS 470-2011, *Fibre Channel – Framing and Signaling – 3 (FC-FS-3)*, December 2011.
- [5] ANSI INCITS 479-2011, *Fibre Channel – Physical Interfaces – 5 (FC-PI-5)*, November 2011.
- [6] ANSI INCITS 488-2016, *Fibre Channel – Framing and Signaling – 4 (FC-FS-4)*, December 2016.
- [7] ANSI INCITS 512-2015, *Fibre Channel – Physical Interfaces – 6 (FC-PI-6)*, January 2015.
- [8] IEEE Std 802.3, *IEEE Standard for Ethernet*, 2018.
- [9] Internet Engineering Task Force RFC 2119, *Key words for use in RFCs to Indicate Requirement Levels*, March 1997.
- [10] Internet Engineering Task Force RFC 2579, *Textual Conventions for SMIV2*, April 1999.
- [11] Internet Engineering Task Force RFC 8174, *Ambiguity of Uppercase vs Lowercase in RFC 2119 Key Words*, May 2017.
- [12] ITU-T Recommendation G.691, *Optical interfaces for single channel STM-64 and other SDH systems with optical amplifiers*, March 2006.
- [13] ITU-T Recommendation G.693, *Optical interfaces for intra-office systems*, November 2009.
- [14] ITU-T Recommendation G.695, *Optical interfaces for coarse wavelength division multiplexing applications*, July 2018.
- [15] ITU-T Recommendation G.707/Y.1322, *Network node interface for the synchronous digital hierarchy (SDH)*, January 2007.
- [16] ITU-T Recommendation G.709/Y.1331, *Interfaces for the optical transport network, Amendment 3*, March 2019.

- [17] ITU-T Recommendation G.783, *Characteristics of synchronous digital hierarchy (SDH) equipment functional blocks*, March 2006.
- [18] ITU-T Recommendation G.798, *Characteristics of optical transport network hierarchy equipment functional blocks, Amendment 1*, August 2018.
- [19] ITU-T Recommendation G.872, *Architecture of optical transport networks*, January 2017.
- [20] ITU-T Recommendation G.873.1, *Optical transport network (OTN): Linear protection*, October 2017.
- [21] ITU-T Recommendation G.957, *Optical interfaces for equipments and systems relating to the synchronous digital hierarchy*, March 2006.
- [22] ITU-T Recommendation G.959.1, *Optical transport network physical layer interfaces*, July 2018.
- [23] ITU-T Recommendation G.7710/Y.1701, *Common equipment management function requirements*, February 2012.
- [24] ITU-T Recommendation G.8201, *Error performance parameters and objectives for multi-operator international paths within optical transport networks*, April 2011.
- [25] MEF 10.4, *Subscriber Ethernet Service Attributes*, December 2018.
- [26] MEF 63, *Subscriber Layer 1 Service Attributes*, August 2018.
- [27] OIF Implementation Agreement OIF-ENNI-OTNv3-AM-01.0, *OTNv3 Amendment to OIF UNI 2.0 and ENNI 2.0/2.1 Common Part*, May 19, 2014.
- [28] Telcordia GR-253-CORE, *Synchronous Optical Network Transport Systems: Common Generic Criteria, Issue 5*, October 2009.

Appendix A Additional Multiplexing Examples (Informative)

In Figure 24, the OTUK is split into parallel lanes referred to as OTLk.n, a group of “n” Optical Transport Lanes (OTL) that carry one OTUK. In this example the value of “n” is four, which means that an OTUK is carried over the four lanes of an OTLk.4. Each of the four lanes is carried over a corresponding OTSi, forming an OTSi Group (OTSiG).

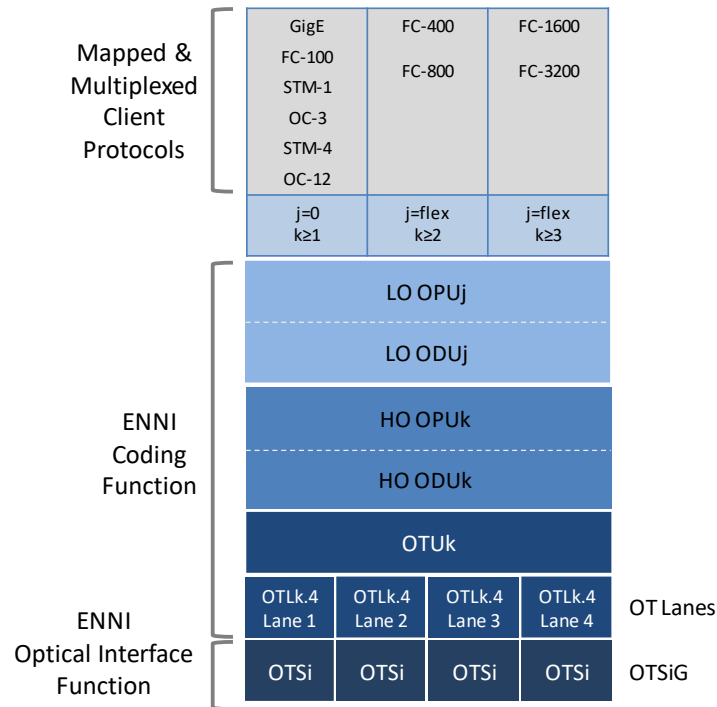

Figure 24 – Example of Mapped & Multiplexed Client Protocols over OTLk.4 and OTSiG

In Figure 25, the directly mapped client protocols are illustrated being multiplexed into HO OPU_k/ODU_k along with the mapped and multiplexed client protocols. Note that for a 100GigE client protocol, which is mapped into a LO OPU₄/ODU₄, there is no higher rate HO OPU/ODU defined for multiplexing (i.e., not considering the OPUC_n/ODUC_n/OTUC_n in this version of the document).

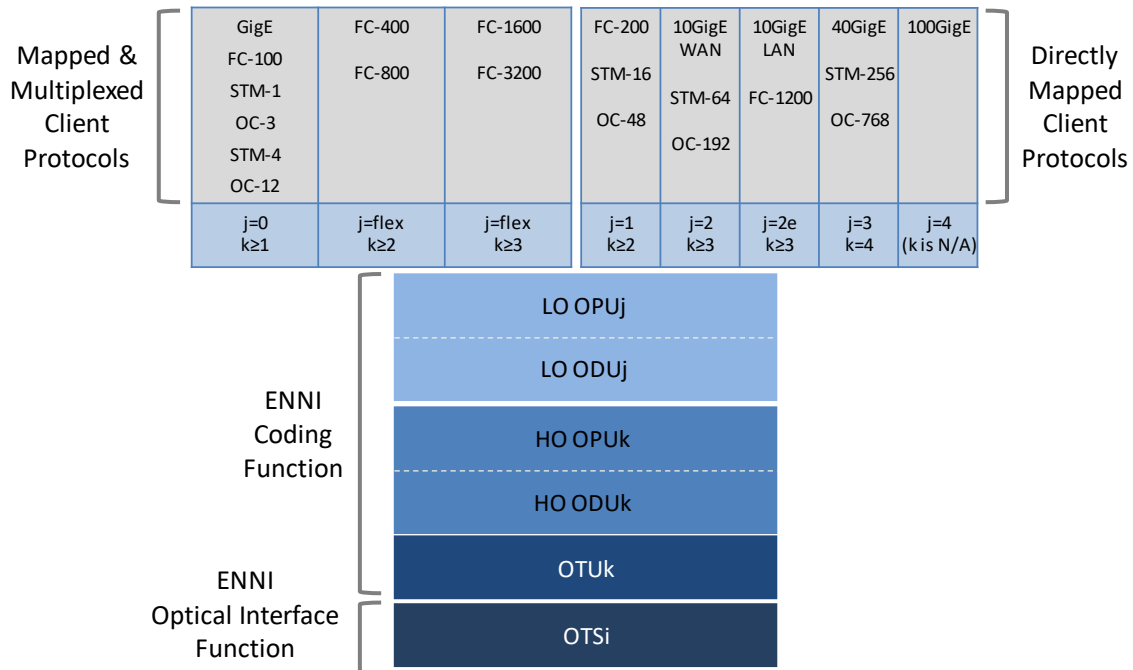

Figure 25 – Example with Directly Mapped Client Protocols included in HO Multiplexing

In Figure 26, the mapped and multiplexed client protocols (i.e., mapped into LO OPU_i/ODU_i and multiplexed into HO OPU_j/ODU_j) are further multiplexed with other HO OPU_j/ODU_j into a Super HO (SHO) OPU_k/ODU_k. This scenario is possible at a Shared ENNI, where Access L1VCs associated with one Service Provider are aggregated into a HO OPU_j/ODU_j, then multiplexed with HO OPU_j/ODU_j associated with other Service Providers into the SHO OPU_k/ODU_k for handoff at the ENNI.

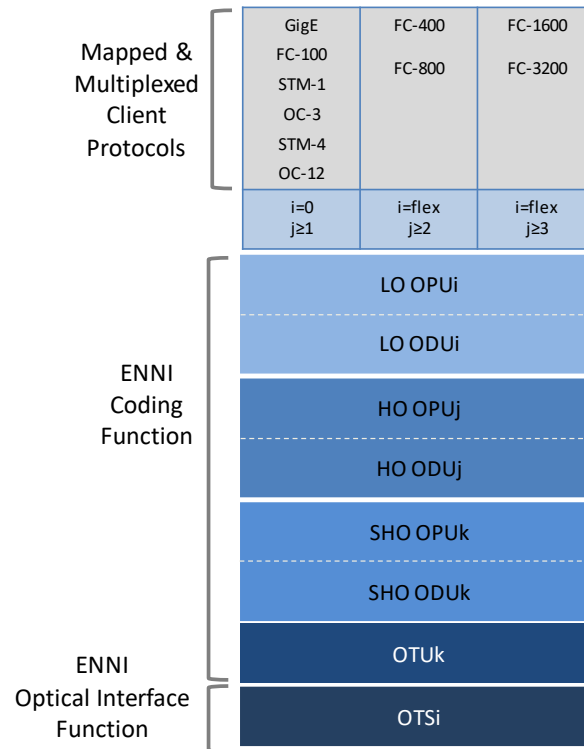

Figure 26 – Example of Mapped & Multiplexed Client Protocols in SHO Multiplexing

Appendix B Relationship Between Operator L1VCs and ODUk Paths (Informative)

An Operator L1VC does not typically correspond to an ODUk path. For example, a possible set of ODUk paths supporting the Operator L1VCs from Figure 14 is shown in Figure 27 (which has been reorganized to compare the Operator L1VCs with the supporting ODUk paths). There are non-OTN path segments at each end of the connectivity between UNI 1 and UNI 2 (e.g., physical links native to the client protocol). Therefore, in this example, UNIs 1 and 2 do not coincide geographically with the locations of the LO ODU2e path overhead termination. Further, ENNI 1 and 2 do not correspond to LO ODU2e path overhead termination points. The same applies for the connectivity between UNIs 3 and 4 in the Operator C and D networks. In this example we assume that a HO ODU3 is used to multiplex and carry the two LO ODU2e across ENNI 1. There is no Operator L1VC associated with the HO ODU3.

The relationship between an Operator L1VC End Point and the LO/HO ODU structure at an ENNI is described by the Operator L1VC End Point Map Service Attribute (Section 8.5.4).

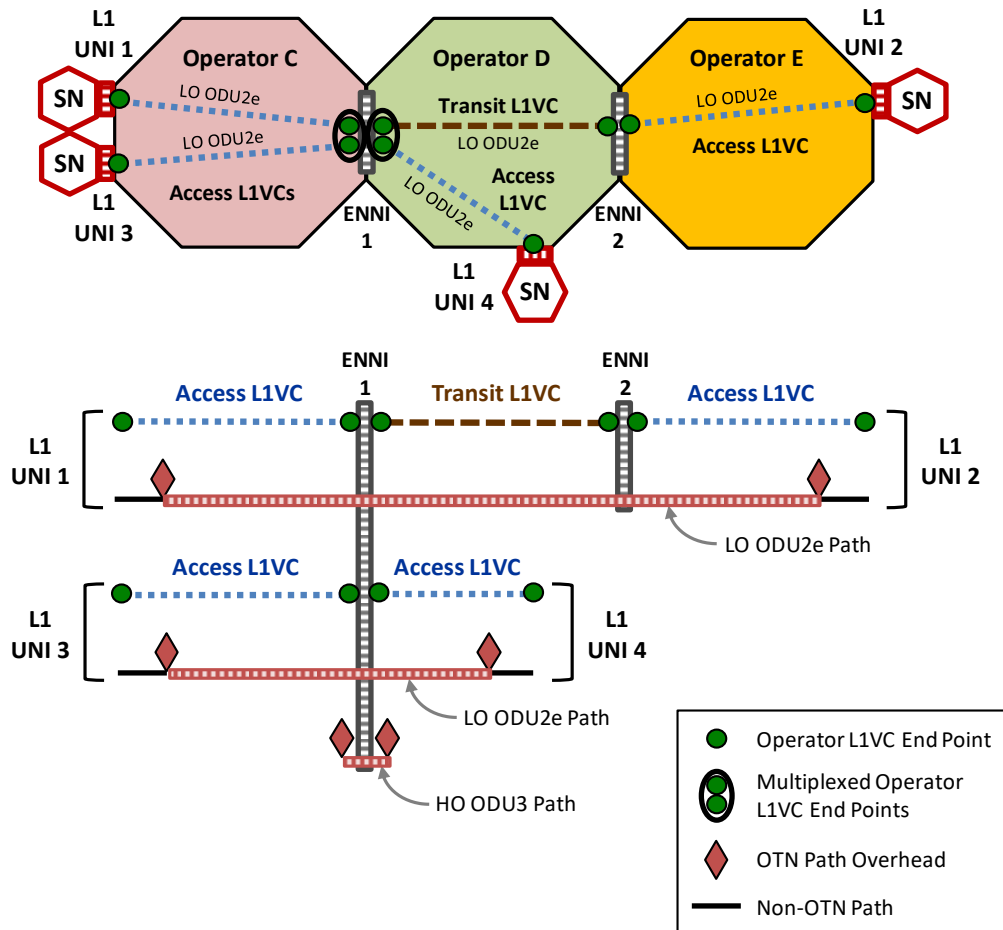

Figure 27 – Operator L1VCs and ODUk Paths Example

The following discusses the value of the Operator Path Overhead Service Attribute (Section 8.2.3) for each of the three Operators in Figure 27. The value of the Operator C Path Overhead Service

Attribute is *List*, with a set of overhead entries (see Table 9) for each LO ODU2e terminated at UNI 1 and UNI 3. The value of the Operator E Path Overhead Service Attribute is *List*, with a set of overhead entries for the LO ODU2e terminated at UNI 2. The SP/SO (not shown in the figure) agrees with Operator C and Operator E to establish consistent values of the overhead entries for the LO ODU2e terminated at UNI 1 and UNI 2, respectively.

The value of the Operator D Path Overhead Service Attribute is *List*, with a set of overhead entries for the LO ODU2e terminated at UNI 4. Note that Operator D does not terminate the LO ODU2e supporting the Transit L1VC, so there is no associated set of overhead entries. The SP/SO agrees with Operator C and Operator D to establish consistent values of the overhead entries for the LO ODU2e terminated at UNI 3 and UNI 4, respectively.

ENNI 1 is a Type 3 ENNI (see Figure 13) and the HO ODU3 overhead values are specified by the ENNI List of Physical Layers Common Attribute (Section 8.1.2), agreed by Operator C and Operator D.

Appendix C ENNI Hairpin Connectivity (Informative)

In the Figure 28 example network, Operator C is unable to provide the desired connectivity between UNI 1 and UNI 3 within its network. The SP/SO arranges for Operator C to provide Access L1VCs from UNI 1 and UNI 2 to ENNI 1 and for Operator D to provide a Transit L1VC with Hairpin Connectivity at ENNI 1. The traffic from the Operator D Transit L1VC End Points at ENNI 1 use different Tributary Slots in the multiplexed HO ODUk across ENNI 1 to the Operator C network. For example, if the Operator C Access L1VCs and the Operator D Transit L1VC are carried in an ODU2e and the value of $k = 3$ for ENNI 1, then the values of the corresponding Operator L1VC End Point Map Service Attribute (Section 8.5.4) could be as listed in the tables in Figure 28.

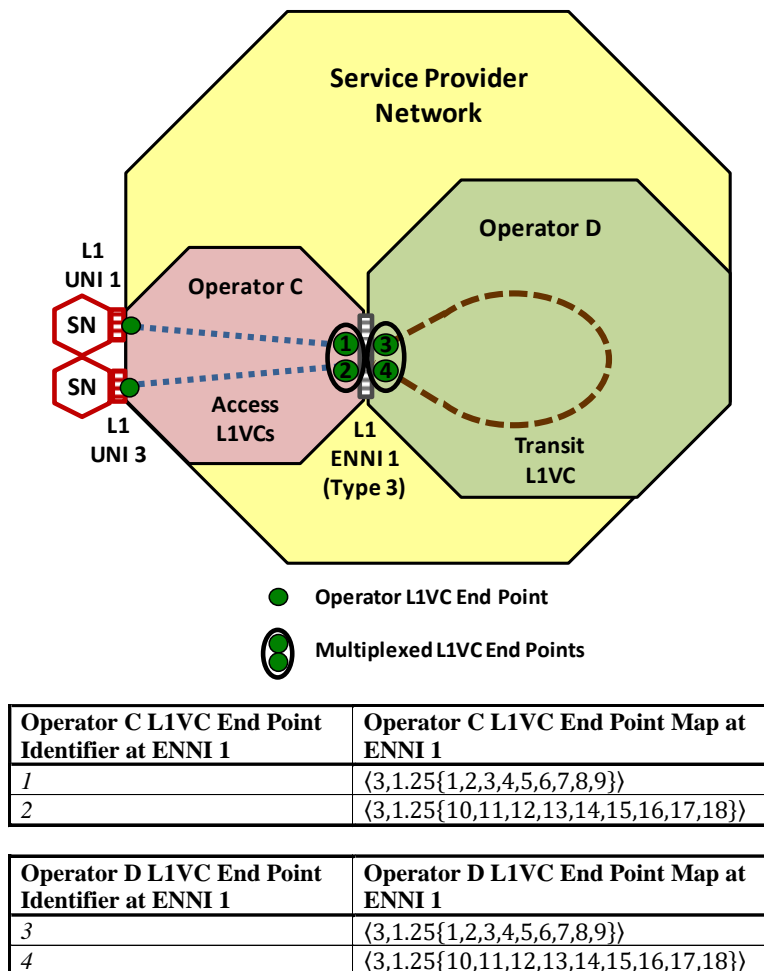

Figure 28 – Example of ENNI Hairpin Connectivity

Appendix D Evaluation of One-way Errored Second Performance Metric (Informative)

The One-way Errored Second Performance Metric is defined in section 8.4.3.4 as:

$$\sum_{\sigma_k \in AT(i,j,T_l)} \left(E_{ES}^{(j)}(\sigma_k) - I_{ES}^{(i)}(\sigma_k) \right)$$

As discussed, for a given second σ_k of Available Time, the set of egress L1CI can be different than the set of ingress L1CI due to the transit delay (e.g., approximately 5ms for 1000km of fibre). An example of the effect of this delay on the evaluation of the One-way Errored Second Performance Metric is illustrated in Figure 29.

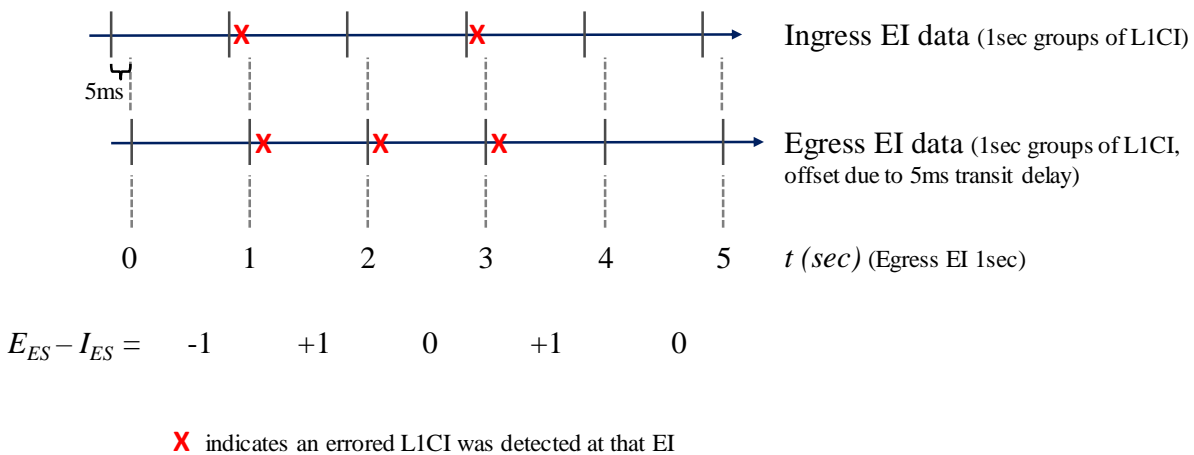

Figure 29 – Example Evaluation of the One-way Errored Second Performance Metric

In the example, the egress EI σ_k is used to determine whether there was an ingress or egress ES. For a delay of 5ms, 0.5% of the L1CI arriving at the ingress EI during a given σ_k will be evaluated in the following σ_k at the egress EI. Note there is a similar effect on the evaluation of the One-way Severely Errored Second Performance Metric.

Appendix E Use Cases (Informative)

The following sections provide examples of Subscriber L1 Service use cases composed of Operator L1 Services.

E.1 Router Interconnect

In this use case, Operator A has two independent business units (BU). The Operator A Metro BU provides typical residential and business services within a metro. The services in different metros are interconnected using routers. The Operator A Transport BU provides the regional interconnect between areas served by the Operator A Metro BU. In the Figure 30 example, the footprint of the Operator A Transport network is supplemented through an arrangement with Operator B to use their national backbone service. Note that in this example the Operator A Metro BU is the Subscriber for the ten Subscriber L1 Services interconnecting the ten pairs of routers and the Operator A Transport BU is the Service Provider.

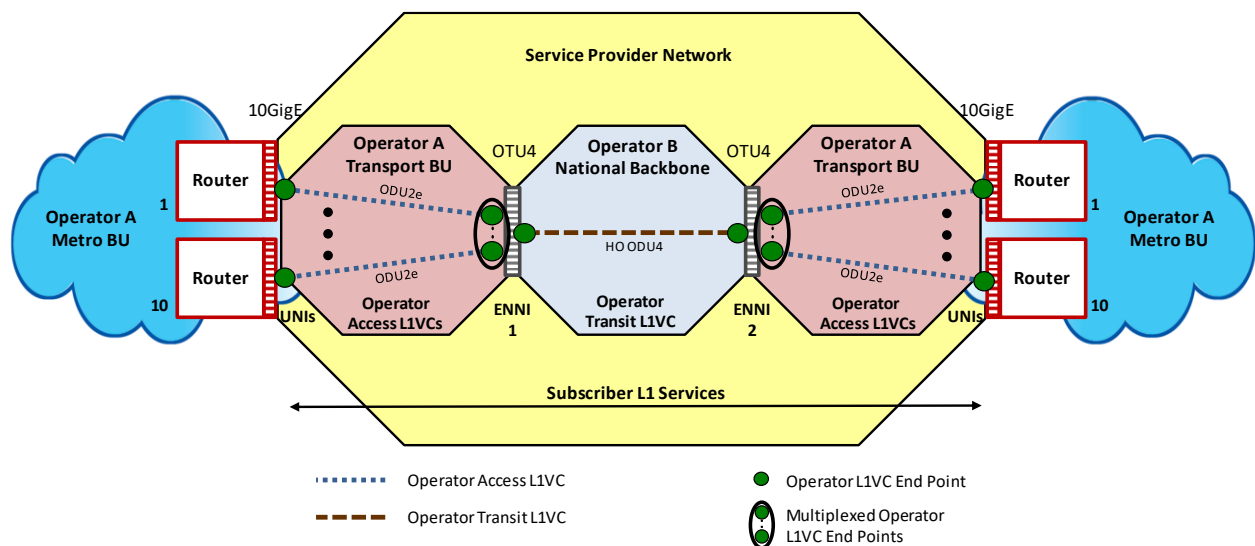

Figure 30 – Router Interconnect Example

The router-to-router transport connectivity is composed of twenty Operator A Access L1VCs (ten in each region) plus a single Operator B Transit L1VC. Each Operator A Access L1VC provides adaptation of a 10GigE client protocol into a LO ODU2e container, which is then multiplexed with other LO ODU2e's into a HO ODU4 for handoff at an ENNI (illustrated by a black ellipse). A pair of short reach (protected) OTU4 optical interfaces (not shown in the figure) is used for each ENNI interconnect. The Operator B Transit L1VC supports the HO ODU4 between ENNIs 1 and 2.

Example ENNI Common Attribute values and Service Attribute values for the Operator A Access L1 Services with Operator L1VC End Points at the left set of UNIs and ENNI 1 and the Operator B Transit L1 Service are provided in the following tables.

ENNI Common Attribute	ENNI 1
ENNI Peering Identifier	<i>Sydney-gateway-1</i>
ENNI List of Physical Layers	Working $\langle c, o \rangle$: $c = \langle 4, \{OTUk\ TTI, Disabled\}, \{OTUk\ GCC0, Disabled\}, \{OTUk\ OSMC, Disabled\}, None \rangle$ $o = 4I1-9D1F$ Protection $\langle c, o \rangle$: $c = \langle 4, \{OTUk\ TTI, Disabled\}, \{OTUk\ GCC0, Disabled\}, \{OTUk\ OSMC, Disabled\}, None \rangle$ $o = 4I1-9D1F$
ENNI Protection	<i>1+1 unidir SNC/I</i>

Table 24 – Example ENNI Common Attribute Values for ENNI 1

Note that ENNI 1 is a Type 2 handoff (see Section 7.3).

The value of the Optical Interface Function $\langle 4I1-9D1F \rangle$ decodes as follows:

- *4*: 4 wavelengths
- *I*: 10km reach
- *I*: single span
- *9*: NRZ 25G class
- *D*: no amplifiers necessary
- *I*: 1310nm source over G.652 fibre
- *F*: G.709 FEC required.

Operator ENNI Service Attribute	Operator A - ENNI 1
Operator ENNI Identifier	<i>Sydney-gateway-1-10GigE-Agg</i>
Operator Multiplexing Capability List	{ <i>ODU0-ODU4: 80, ODU1-ODU4: 40, ODU2-ODU4: 10, ODU2e-ODU4: 10</i> }
Operator Path Overhead	<p>ODU2e for Access L1VC 1: {<i>ODU TTI, Enabled</i>}, {<i>ODU GCC1, Disabled</i>}, {<i>ODU GCC2, Disabled</i>}, {<i>ODU APS, Disabled</i>}</p> <p>ODU2e for Access L1VC 2: {<i>ODU TTI, Enabled</i>}, {<i>ODU GCC1, Disabled</i>}, {<i>ODU GCC2, Disabled</i>}, {<i>ODU APS, Disabled</i>}</p> <p>ODU2e for Access L1VC 3: {<i>ODU TTI, Enabled</i>}, {<i>ODU GCC1, Disabled</i>}, {<i>ODU GCC2, Disabled</i>}, {<i>ODU APS, Disabled</i>}</p> <p>ODU2e for Access L1VC 4: {<i>ODU TTI, Enabled</i>}, {<i>ODU GCC1, Disabled</i>}, {<i>ODU GCC2, Disabled</i>}, {<i>ODU APS, Disabled</i>}</p> <p>ODU2e for Access L1VC 5: {<i>ODU TTI, Enabled</i>}, {<i>ODU GCC1, Disabled</i>}, {<i>ODU GCC2, Disabled</i>}, {<i>ODU APS, Disabled</i>}</p> <p>ODU2e for Access L1VC 6: {<i>ODU TTI, Enabled</i>}, {<i>ODU GCC1, Disabled</i>}, {<i>ODU GCC2, Disabled</i>}, {<i>ODU APS, Disabled</i>}</p> <p>ODU2e for Access L1VC 7: {<i>ODU TTI, Enabled</i>}, {<i>ODU GCC1, Disabled</i>}, {<i>ODU GCC2, Disabled</i>}, {<i>ODU APS, Disabled</i>}</p> <p>ODU2e for Access L1VC 8: {<i>ODU TTI, Enabled</i>}, {<i>ODU GCC1, Disabled</i>}, {<i>ODU GCC2, Disabled</i>}, {<i>ODU APS, Disabled</i>}</p> <p>ODU2e for Access L1VC 9: {<i>ODU TTI, Enabled</i>}, {<i>ODU GCC1, Disabled</i>}, {<i>ODU GCC2, Disabled</i>}, {<i>ODU APS, Disabled</i>}</p> <p>ODU2e for Access L1VC 10: {<i>ODU TTI, Enabled</i>}, {<i>ODU GCC1, Disabled</i>}, {<i>ODU GCC2, Disabled</i>}, {<i>ODU APS, Disabled</i>}</p> <p>HO ODU4: {<i>ODU TTI, Enabled</i>}, {<i>ODU GCC1, Disabled</i>}, {<i>ODU GCC2, Disabled</i>}, {<i>ODU APS, Disabled</i>}</p>

Table 25 – Example Operator ENNI Service Attribute Values for Operator A at ENNI 1

In the Figure 30 example, the Operator A Transport BU is using the *ODU2e-ODU4: 10* multiplexing sequence at both ENNIs.

Operator UNI Service Attribute	UNI 1
Operator UNI Identifier	<i>Metro-Node3-Slot2-Port1</i>
Operator UNI Physical Layer	<i><Ethernet, 10GBASE-R PCS clause 49 coding function, LR PMD clause 52></i>

Table 26 – Example Operator UNI Service Attribute Values for Operator A Access L1 Service 1

Operator L1VC Service Attribute	Operator A Access L1VC 1		
Operator L1VC Identifier	<i>Access-L1VC-1-Metro-Sydney</i>		
Operator L1VC End Point List	<i>{Metro-1, Sydney-1}</i>		
Operator L1VC SLS	<i>t_s</i>	<i>2018-07-01, 08:00:00 UTC</i>	
	<i>T</i>	<i>one calendar month</i>	
	<i>PM</i>	<i>One-way Availability Performance Metric</i>	
		<i>{Metro-1, Sydney-1}</i>	
		<i>99.999%</i>	
		<i>One-way Availability Performance Metric</i>	
		<i>{Sydney-1, Metro-1}</i>	
<i>99.999%</i>			

Table 27 – Example Operator L1VC Service Attribute Values for Operator A Access L1 Service 1

See Section 8.4.3 for the definition of the *PM* entry.

Operator L1VC End Point Service Attribute	Operator L1VC End Point at ENNI 1
Operator L1VC End Point Identifier	<i>Sydney-1</i>
Operator L1VC End Point External Interface Type	<i>ENNI</i>
Operator L1VC End Point External Interface Identifier	<i>Sydney-gateway-1-10GigE-Agg</i>
Operator L1VC End Point Map	<i>{4,1.25{1,2,3,4,5,6,7,8}}</i>

Table 28 – Example Service Attribute Values for the Operator L1VC End Point at ENNI 1 for the Operator A Access L1 Service 1

Table 29 lists example values for the Operator L1VC End Point Map Service Attribute at ENNI 1 for the remaining nine Operator A Access L1 Services.

Operator L1VC End Point Identifier at ENNI 1	Operator L1VC End Point Map at ENNI 1
<i>Sydney-2</i>	<i>{4,1.25{9,10,11,12,13,14,15,16}}</i>
<i>Sydney-3</i>	<i>{4,1.25{17,18,19,20,21,22,23,24}}</i>
<i>Sydney-4</i>	<i>{4,1.25{25,26,27,28,29,30,31,32}}</i>
<i>Sydney-5</i>	<i>{4,1.25{33,34,35,36,37,38,39,40}}</i>
<i>Sydney-6</i>	<i>{4,1.25{41,42,43,44,45,46,47,48}}</i>
<i>Sydney-7</i>	<i>{4,1.25{49,50,51,52,53,54,55,56}}</i>
<i>Sydney-8</i>	<i>{4,1.25{57,58,59,60,61,62,63,64}}</i>
<i>Sydney-9</i>	<i>{4,1.25{65,66,67,68,69,70,71,72}}</i>
<i>Sydney-10</i>	<i>{4,1.25{73,74,75,76,77,78,79,80}}</i>

Table 29 – Example Service Attribute Values for the Operator L1VC End Point Maps at ENNI 1 for the Operator A Access L1 Services 2 through 10

Operator L1VC End Point Service Attribute	Operator L1VC End Point at UNI 1
Operator L1VC End Point Identifier	<i>Metro-1</i>
Operator L1VC End Point External Interface Type	<i>UNI</i>
Operator L1VC End Point External Interface Identifier	<i>Metro-Node3-Slot2-Port1</i>
Operator L1VC End Point Map	<i>Not Applicable</i>

Table 30 – Example Service Attribute Values for the Operator L1VC End Point at UNI 1 for the Operator A Access L1 Service 1

Operator ENNI Service Attribute	Operator B - ENNI 1	Operator B - ENNI 2
Operator ENNI Identifier	<i>Sydney-gateway-1-100G</i>	<i>Melbourne-gateway-1-100G</i>
Operator Multiplexing Capability List	{ <i>ODU1-ODU4: 40, ODU2-ODU4: 10, ODU2e-ODU4: 10</i> }	{ <i>ODU1-ODU4: 40, ODU2-ODU4: 10, ODU2e-ODU4: 10</i> }
Operator Path Overhead	<i>None</i>	<i>None</i>

Table 31 – Example Operator ENNI Service Attribute Values for the Operator B Transit L1 Service

Note that in the Figure 30 example, Operator B is not providing any multiplexing at the ENNIs. This is identified by the values of the corresponding Operator L1VC End Point Map entries in Table 33.

Operator L1VC Service Attribute	Operator B Transit L1VC 1		
Operator L1VC Identifier	<i>Transit-L1VC-1-Sydney-Melbourne</i>		
Operator L1VC End Point List	<i>{Sydney-GW-1, Melbourne-GW-1}</i>		
Operator L1VC SLS	<i>t_s</i>	<i>2018-07-01, 08:00:00 UTC</i>	
	<i>T</i>	<i>one calendar month</i>	
	<i>PM</i>	<i>One-way Availability Performance Metric</i>	
		<i>{Sydney-GW-1, Melbourne-GW-1}</i>	
		<i>99.999%</i>	
		<i>One-way Availability Performance Metric</i>	
<i>{Melbourne-GW-1, Sydney-GW-1}</i>			
<i>99.999%</i>			

Table 32 – Example Operator L1VC Service Attribute Values for the Operator B Transit L1 Service

See Section 8.4.3 for the definition of the *PM* entry.

Operator L1VC End Point Service Attribute	Operator L1VC End Point at ENNI 1	Operator L1VC End Point at ENNI 2
Operator L1VC End Point Identifier	<i>Sydney-GW-1</i>	<i>Melbourne-GW-1</i>
Operator L1VC End Point External Interface Type	<i>ENNI</i>	<i>ENNI</i>
Operator L1VC End Point External Interface Identifier	<i>Sydney-gateway-1-100G</i>	<i>Melbourne-gateway-1-100G</i>
Operator L1VC End Point Map	<i><4, Null></i>	<i><4, Null></i>

Table 33 – Example Service Attribute Values for the Operator L1VC End Points for the Operator B Transit L1 Service

E.2 Enterprise Computing Interconnect

In the Figure 31 use case, Operator D is also the Service Provider and offers business services (i.e., Subscriber L1 Services) to Enterprises, specifically the interconnection of individual campuses with their remote computing resources. The following discussion provides a description of the use case connectivity for Enterprise 1, working from right to left. In the north Operator D geographic region, each Access L1VC provides adaptation of a 10GigE client protocol into a LO ODU2e container, which is carried separately for handoff at geographically diverse ENNI 4 and 5. A pair of short reach (protected) OTU2e optical interfaces (not shown in the figure) is used for ENNI 4 and another pair for ENNI 5. In the south Operator D geographic region, eight Access L1VCs provide similar connectivity, they are aggregated into a (partial fill) HO ODU4 for handoff at ENNI 3 (illustrated by the black ellipse). A pair of short reach OTU4 optical interfaces is used for the ENNI 3 interconnect.

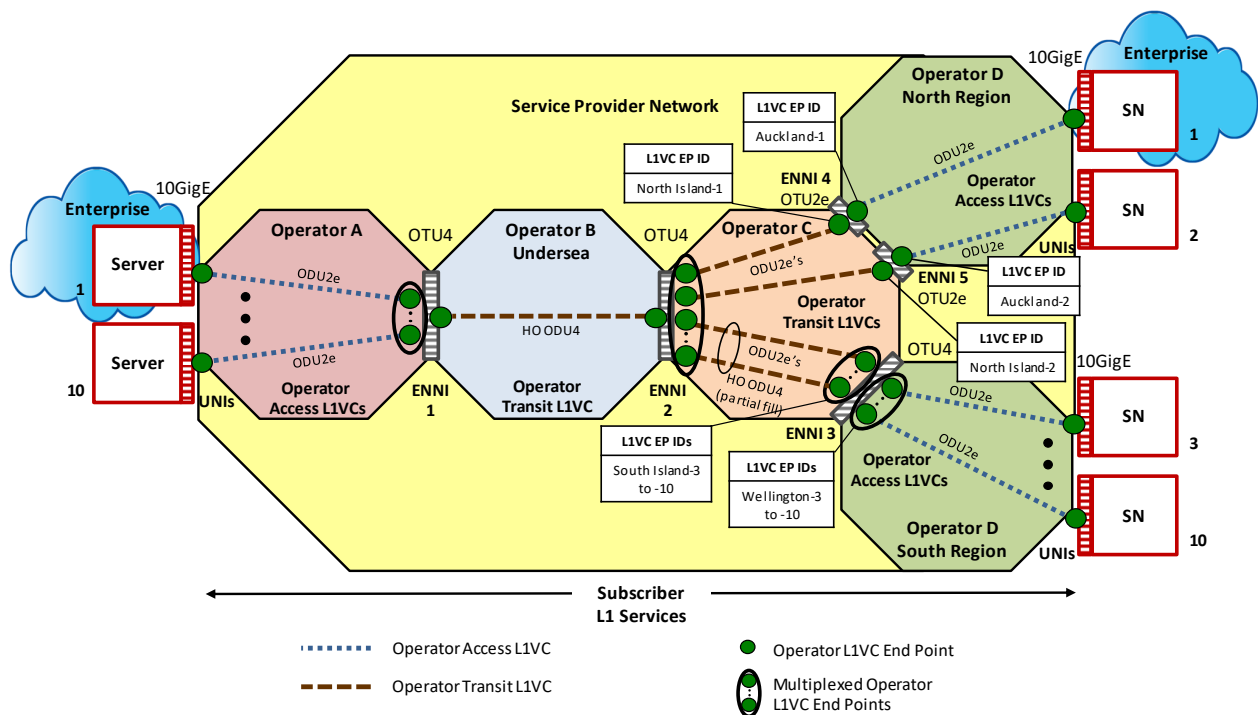

Figure 31 – Enterprise Computing Interconnect Example

Operator C provides aggregation of the two ODU2e Transit L1VCs (from ENNI 4 and 5) with the eight ODU2e Transit L1VCs²⁵ carried in a partial fill HO ODU4 (from ENNI 3), into a full fill (ten ODU2e's) HO ODU4 for handoff at the undersea landing site at ENNI 2 (illustrated by the black ellipse). A pair of short reach OTU4 optical interfaces is used for the ENNI 2 interconnect. The Operator B Transit L1VC supports the HO ODU4 between ENNI 1 and 2. A pair of short reach OTU4 optical interfaces is used for the ENNI 1 landing site interconnect. Operator A demultiplexes the HO ODU4 into ten Access L1VCs (illustrated by the black ellipse) and delivers

²⁵ There are eight Operator C L1VC End Point Maps at ENNI 3, one for each LO ODU2e (matching the eight Operator D L1VC End Point Maps). Note that the L1VC End Point Maps apply to the ENNI connectivity, not how the L1VCs are transported within an Operator's network.

each one to its corresponding Enterprise, where each 10GigE client protocol is demapped from its LO ODU2e container prior to the UNI handoff.

The Operator A Access L1VCs and aggregation thereof provide similar connectivity to those from the Operator A Transport BU in the E.1 example. Therefore, the example Service Attribute values in the associated tables could also apply to this use case (i.e., Table 24 through Table 30). Similarly, for the Operator B Transit L1VC in the E.1 example (i.e., Table 31 through Table 33) and this use case.

Table 34 lists example values for the Operator D North Region Operator L1VC End Point Map Service Attribute at ENNIs 4 and 5 for two Operator D Access L1 Services.

Operator L1VC End Point Identifier	ENNI	Operator L1VC End Point Map
<i>Auckland-1</i>	4	$\langle 2e, Null \rangle$
<i>Auckland-2</i>	5	$\langle 2e, Null \rangle$

Table 34 – Example Service Attribute Values for the Operator L1VC End Point Maps at ENNIs 4 and 5 for the Operator D Access L1 Services 1 and 2

Table 35 lists example values for the Operator D South Region Operator L1VC End Point Map Service Attribute at ENNI 3 for eight Operator D Access L1 Services.

Operator L1VC End Point Identifier at ENNI 3	Operator L1VC End Point Map at ENNI 3
<i>Wellington-3</i>	$\langle 4, 1.25\{17, 18, 19, 20, 21, 22, 23, 24\} \rangle$
<i>Wellington-4</i>	$\langle 4, 1.25\{25, 26, 27, 28, 29, 30, 31, 32\} \rangle$
<i>Wellington-5</i>	$\langle 4, 1.25\{33, 34, 35, 36, 37, 38, 39, 40\} \rangle$
<i>Wellington-6</i>	$\langle 4, 1.25\{41, 42, 43, 44, 45, 46, 47, 48\} \rangle$
<i>Wellington-7</i>	$\langle 4, 1.25\{49, 50, 51, 52, 53, 54, 55, 56\} \rangle$
<i>Wellington-8</i>	$\langle 4, 1.25\{57, 58, 59, 60, 61, 62, 63, 64\} \rangle$
<i>Wellington-9</i>	$\langle 4, 1.25\{65, 66, 67, 68, 69, 70, 71, 72\} \rangle$
<i>Wellington-10</i>	$\langle 4, 1.25\{73, 74, 75, 76, 77, 78, 79, 80\} \rangle$

Table 35 – Example Service Attribute Values for the Operator L1VC End Point Maps at ENNI 3 for the Operator D Access L1 Services 3 through 10

Table 36 lists example values for the Operator C L1VC End Point Map Service Attribute at ENNIs 3, 4 and 5 for the Operator C Transit L1 Services.

Operator L1VC End Point Identifier	ENNI	Operator L1VC End Point Map
<i>North-Island-1</i>	4	$\langle 2e, Null \rangle$
<i>North-Island-2</i>	5	$\langle 2e, Null \rangle$
<i>South-Island-3</i>	3	$\langle 4, 1.25\{17,18,19,20,21,22,23,24\} \rangle$
<i>South-Island-4</i>		$\langle 4, 1.25\{25,26,27,28,29,30,31,32\} \rangle$
<i>South-Island-5</i>		$\langle 4, 1.25\{33,34,35,36,37,38,39,40\} \rangle$
<i>South-Island-6</i>		$\langle 4, 1.25\{41,42,43,44,45,46,47,48\} \rangle$
<i>South-Island-7</i>		$\langle 4, 1.25\{49,50,51,52,53,54,55,56\} \rangle$
<i>South-Island-8</i>		$\langle 4, 1.25\{57,58,59,60,61,62,63,64\} \rangle$
<i>South-Island-9</i>		$\langle 4, 1.25\{65,66,67,68,69,70,71,72\} \rangle$
<i>South-Island-10</i>		$\langle 4, 1.25\{73,74,75,76,77,78,79,80\} \rangle$

Table 36 – Example Service Attribute Values for the Operator L1VC End Point Maps at ENNIs 3, 4 and 5 for the Operator C Transit L1 Services

E.3 Cloud Computing Access

In the Figure 32 use case, the Operator B Cloud Computing BU provides typical cloud services from its data center for ten Enterprise customers within the metro. The Operator B Cloud Computing BU owns the servers and is also the Service Provider for the transport connectivity. Each Enterprise is a Subscriber of a Subscriber L1 Service and a customer of the cloud service provided by the Operator B Cloud Computing BU. From each Enterprise SN perspective, a Subscriber L1 Service provides 10GigE connectivity to a corresponding server in the Operator B Cloud Computing BU data center. Each Subscriber L1 Service is composed of a Subscriber L1VC and its two Subscriber L1VC End Points.

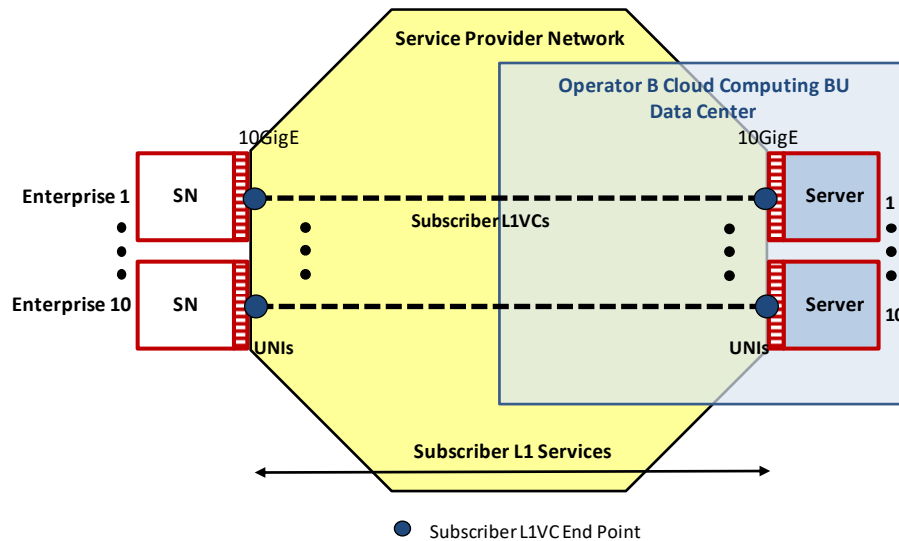

Figure 32 – Cloud Computing Access Example: Subscriber L1VCs

Figure 33 illustrates the example of Figure 32 expanded to show that Operator B is composed of two independent BUs, the Operator B Cloud Computing BU and the Operator B Transport BU. The Operator B Transport BU, on behalf of the Operator B Cloud Computing BU, provides the interconnections within the Operator B Cloud Computing BU data center and coordinates with Operator A to establish the necessary connectivity across the metro to each of the ten Enterprise SNs. The transport connectivity between each Enterprise SN and corresponding server is provided by one Operator A Access L1VC and one Operator B Access L1VC. Each Operator Access L1VC provides adaptation of a 10GigE client protocol into a LO ODU2e container, which is then aggregated with the other LO ODU2e's into a HO ODU4 for handoff at the ENNI within the Operator B Cloud Computing BU data center (illustrated by each black ellipse). A pair of short reach (protected) OTU4 optical interfaces (not shown in the figure) is used for the ENNI interconnect.

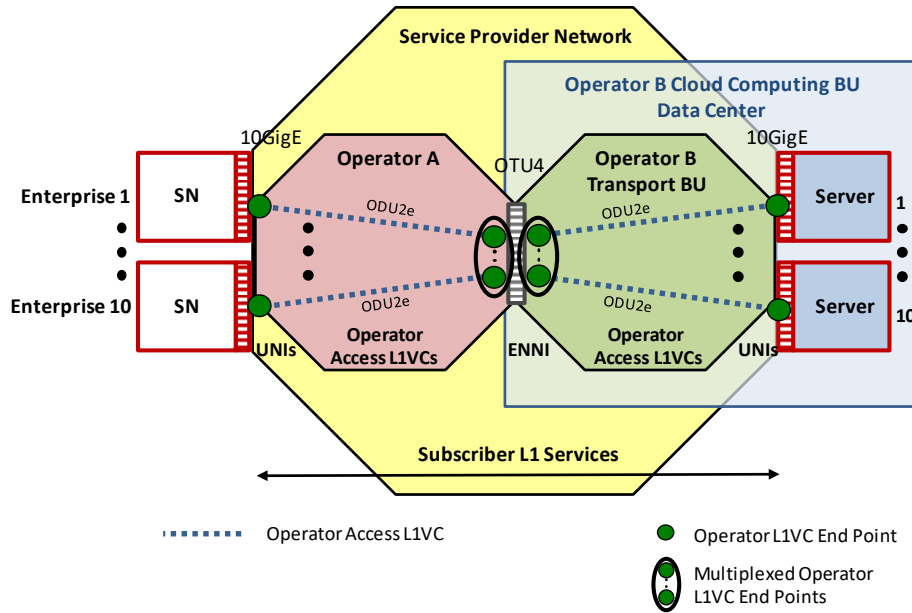

Figure 33 – Cloud Computing Access Example: Operator L1VCs

Appendix F Shared ENNI (Informative)

In the Figure 34 example of a Shared ENNI, Operator A provides Access L1VCs for Service Provider X and Service Provider Y to ENNI 1 (the corresponding UNIs and Service Provider networks are not shown for simplicity). The traffic from the Operator A Access L1VC End Points (labelled 1 and 2 in the figure) for Service Provider X, supported by LO ODU2s, is first multiplexed into a HO ODU3 (not shown) which is further multiplexed with a similarly formed HO ODU3 (not shown) for Service Provider Y into a SHO ODU4 (not shown) for the Type 3 handoff (see Figure 13) at ENNI 1 to Operator B.

Operator B demultiplexes the SHO ODU4 at ENNI 1 into the two HO ODU3s with corresponding Operator B Transit L1VC End Points (labelled 5 and 6 in the figure) for each Service Provider (the other ENNIs are not shown for simplicity).

The tables in Figure 34 provide the values of the Operator L1VC End Point Map Service Attribute (Section 8.5.4) for each Operator L1VC End Point at ENNI 1. Service Provider X agrees with Operator A on the values for the Operator A L1VC End Point Map for Operator L1VC End Points 1 and 2. Service Provider Y agrees with Operator A on the values for the Operator A L1VC End Point Map for Operator L1VC End Points 3 and 4. Service Provider X agrees with Operator B on the value of the Operator B L1VC End Point Map for Operator L1VC End Point 5. Service Provider Y agrees with Operator B on the value of the Operator B L1VC End Point Map for Operator L1VC End Point 6.

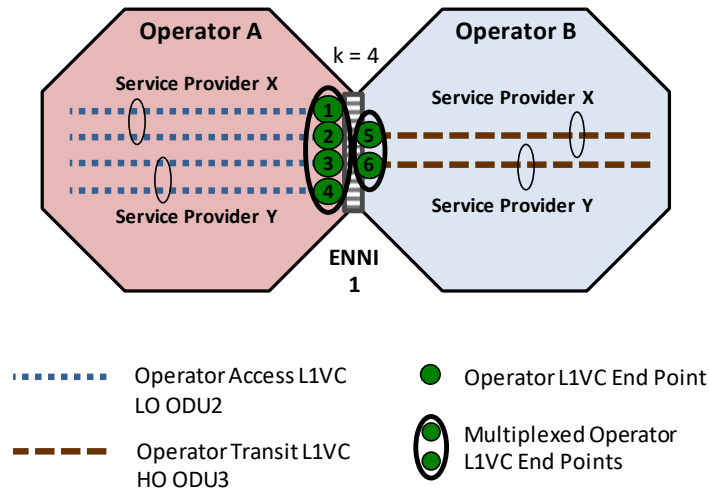

Operator A L1VC End Point Identifier at ENNI 1	Operator A L1VC End Point Map at ENNI 1
1	{3,1.25{1,2,3,4,5,6,7,8}}, {4,1.25{1,2,3,4,5,6,7,8,9,10,11,12,13,14,15,16,17,18,19,20,21,22,23,24,25,26,27,28,29,30,31}}
2	{3,1.25{9,10,11,12,13,14,15,16}} {4,1.25{1,2,3,4,5,6,7,8,9,10,11,12,13,14,15,16,17,18,19,20,21,22,23,24,25,26,27,28,29,30,31}}
3	{3,1.25{1,2,3,4,5,6,7,8}}, {4,1.25{32,33,34,35,36,37,38,39,40,41,42,43,44,45,46,47,48,49,50,51,52,53,54,55,56,57,58,59,60,61,62}}
4	{3,1.25{9,10,11,12,13,14,15,16}}, {4,1.25{32,33,34,35,36,37,38,39,40,41,42,43,44,45,46,47,48,49,50,51,52,53,54,55,56,57,58,59,60,61,62}}

Operator B L1VC End Point Identifier at ENNI 1	Operator B L1VC End Point Map at ENNI 1
5	{4,1.25{1,2,3,4,5,6,7,8,9,10,11,12,13,14,15,16,17,18,19,20,21,22,23,24,25,26,27,28,29,30,31}}
6	{4,1.25{32,33,34,35,36,37,38,39,40,41,42,43,44,45,46,47,48,49,50,51,52,53,54,55,56,57,58,59,60,61,62}}

Figure 34 – Shared ENNI Example