



**MEF Standard  
MEF 61.1**

**IP Service Attributes**

**May 2019**

## Disclaimer

© MEF Forum 2019. All Rights Reserved.

The information in this publication is freely available for reproduction and use by any recipient and is believed to be accurate as of its publication date. Such information is subject to change without notice and MEF Forum (MEF) is not responsible for any errors. MEF does not assume responsibility to update or correct any information in this publication. No representation or warranty, expressed or implied, is made by MEF concerning the completeness, accuracy, or applicability of any information contained herein and no liability of any kind shall be assumed by MEF as a result of reliance upon such information.

The information contained herein is intended to be used without modification by the recipient or user of this document. MEF is not responsible or liable for any modifications to this document made by any other party.

The receipt or any use of this document or its contents does not in any way create, by implication or otherwise:

- a) any express or implied license or right to or under any patent, copyright, trademark or trade secret rights held or claimed by any MEF member which are or may be associated with the ideas, techniques, concepts or expressions contained herein; nor
- b) any warranty or representation that any MEF members will announce any product(s) and/or service(s) related thereto, or if such announcements are made, that such announced product(s) and/or service(s) embody any or all of the ideas, technologies, or concepts contained herein; nor
- c) any form of relationship between any MEF member and the recipient or user of this document.

Implementation or use of specific MEF standards, specifications, or recommendations will be voluntary, and no Member shall be obliged to implement them by virtue of participation in MEF Forum. MEF is a non-profit international organization to enable the development and worldwide adoption of agile, assured and orchestrated network services. MEF does not, expressly or otherwise, endorse or promote any specific products or services.

## Table of Contents

<b>1</b>	<b>List of Contributing Members</b> .....	<b>1</b>
<b>2</b>	<b>Abstract</b> .....	<b>1</b>
<b>3</b>	<b>Terminology and Abbreviations</b> .....	<b>2</b>
<b>4</b>	<b>Compliance Levels</b> .....	<b>7</b>
<b>5</b>	<b>Numerical Prefix Conventions</b> .....	<b>7</b>
<b>6</b>	<b>Introduction</b> .....	<b>8</b>
<b>7</b>	<b>Key Concepts for Subscriber IP Services</b> .....	<b>10</b>
7.1	Subscriber IP Services .....	10
7.2	Service Attributes .....	11
7.3	UNIs and UNI Access Links .....	12
7.4	IP Virtual Connections and IPVC End Points .....	16
7.5	Subscriber-Managed and Provider-Managed CEs .....	17
7.6	Service Assurance.....	20
7.7	Virtual Private Network (VPN) Services .....	20
7.8	Extranet Services .....	21
7.9	Internet and Cloud Access Services .....	24
7.9.1	Internet Access.....	24
7.9.2	Private Cloud Access .....	25
7.10	IPVC Topology.....	26
7.11	IP Subscriber Services Framework.....	27
7.12	IP Packets .....	27
<b>8</b>	<b>Key Concepts for Operator IP Services</b> .....	<b>29</b>
8.1	Operator IP Services .....	29
8.2	ENNI and ENNI Links.....	32
8.3	Service Attributes for Operator IP Services .....	32
8.4	IP Operator Service Hierarchy .....	35
8.5	Operator IP Service Framework .....	36
8.6	Connecting Services across an ENNI.....	37
8.7	Rooted Multipoint Services across an ENNI.....	41
<b>9</b>	<b>Routing and Packet Delivery in an IPVC</b> .....	<b>44</b>
9.1	IP Routing in an SP or Operator Network.....	44
9.1.1	UNI Routing Information Database .....	45
9.1.2	ENNI Service Mapping Context Routing Information Database.....	46
9.1.3	IPVC EP Local Routing Information Database .....	46
9.1.4	IPVC EP Remote Routing Information Database .....	48
9.1.5	IPVC EP Routing Table .....	48
9.1.6	Summary .....	49
9.2	IP Routing Across an ENNI .....	51
9.3	IP Packet Delivery .....	52
9.3.1	Selecting an Ingress IPVC EP.....	52
9.3.2	Delivering IP Packets across an IPVC .....	58
9.4	IP Data Packet Transparency.....	59

<b>10</b>	<b>IPVC Service Attributes.....</b>	<b>62</b>
10.1	IPVC Identifier Service Attribute.....	63
10.2	IPVC Topology Service Attribute.....	63
10.3	IPVC End Point List Service Attribute.....	63
10.4	IPVC Packet Delivery Service Attribute.....	64
10.5	IPVC Maximum Number of IPv4 Routes Service Attribute.....	66
10.6	IPVC Maximum Number of IPv6 Routes Service Attribute.....	67
10.7	IPVC DSCP Preservation Service Attribute.....	69
10.8	IPVC List of Class of Service Names Service Attribute.....	69
10.9	IPVC Service Level Specification Service Attribute.....	70
10.9.1	SLS Reference Points.....	72
10.9.2	Qualified Packets.....	75
10.9.3	One-way Packet Delay.....	76
10.9.4	One-way Packet Delay Percentile Performance Metric.....	77
10.9.5	One-way Mean Packet Delay Performance Metric.....	78
10.9.6	One-way Inter-Packet Delay Variation Performance Metric.....	78
10.9.7	One-way Packet Delay Range Performance Metric.....	80
10.9.8	One-way Packet Loss Ratio Performance Metric.....	81
10.9.9	Service Uptime Performance Metric.....	82
10.10	IPVC MTU Service Attribute.....	83
10.11	IPVC Path MTU Discovery Service Attribute.....	84
10.12	IPVC Fragmentation Service Attribute.....	85
10.13	IPVC Cloud Service Attribute.....	85
10.13.1	Cloud Type.....	86
10.13.2	Cloud Ingress Class of Service Map.....	86
10.13.3	Cloud Data Limit.....	89
10.13.4	Cloud Network Address Translation.....	89
10.13.5	Cloud DNS Service.....	90
10.13.6	Cloud Subscriber Prefix List.....	91
10.14	IPVC Reserved Prefixes Service Attribute.....	92
<b>11</b>	<b>IPVC End Point Service Attributes.....</b>	<b>93</b>
11.1	IPVC EP Identifier Service Attribute.....	94
11.2	IPVC EP EI Type Service Attribute.....	94
11.3	IPVC EP EI Service Attribute.....	94
11.4	IPVC EP Role Service Attribute.....	95
11.5	IPVC EP Prefix Mapping Service Attribute.....	96
11.5.1	Mapping IP Data Packets to an IPVC.....	97
11.6	IPVC EP ENNI Service Mapping Identifier Service Attribute.....	100
11.7	IPVC EP Maximum Number of IPv4 Routes Service Attribute.....	101
11.8	IPVC EP Maximum Number of IPv6 Routes Service Attribute.....	102
11.9	IPVC EP Ingress Class of Service Map Service Attribute.....	102
11.10	IPVC EP Egress Class of Service Map Service Attribute.....	106
11.11	IPVC EP Ingress Bandwidth Profile Envelope Service Attribute.....	108
11.12	IPVC EP Egress Bandwidth Profile Envelope Service Attribute.....	108
<b>12</b>	<b>UNI Service Attributes.....</b>	<b>109</b>
12.1	UNI Identifier Service Attribute.....	109

12.2	UNI Management Type Service Attribute.....	110
12.3	UNI List of UNI Access Links Service Attribute.....	110
12.4	UNI Ingress Bandwidth Profile Envelope Service Attribute.....	110
12.5	UNI Egress Bandwidth Profile Envelope Service Attribute .....	111
12.6	UNI List of Control Protocols Service Attribute.....	111
12.7	UNI Routing Protocols Service Attribute.....	114
12.7.1	Static.....	116
12.7.2	OSPF.....	116
12.7.3	BGP.....	117
12.8	UNI Reverse Path Forwarding Service Attribute .....	120
<b>13</b>	<b>UNI Access Link Service Attributes.....</b>	<b>122</b>
13.1	UNI Access Link Identifier Service Attribute.....	123
13.2	UNI Access Link Connection Type Service Attribute .....	123
13.3	UNI Access Link L2 Technology Service Attribute .....	124
13.3.1	Physical Point-to-Point Ethernet Link.....	125
13.3.2	Multipoint Ethernet Link over WiFi .....	125
13.3.3	VLAN over an Ethernet Link Aggregation Group.....	125
13.3.4	Physical Ethernet Link using VRRP .....	125
13.3.5	Point to Point Protocol (PPP).....	126
13.3.6	Point-to-Point Ethernet Link using an E-Access service .....	127
13.4	UNI Access Link IPv4 Connection Addressing Service Attribute.....	127
13.5	UNI Access Link IPv6 Connection Addressing Service Attribute.....	131
13.6	UNI Access Link DHCP Relay Service Attribute.....	133
13.7	UNI Access Link Prefix Delegation Service Attribute .....	134
13.8	UNI Access Link BFD Service Attribute .....	136
13.9	UNI Access Link IP MTU Service Attribute .....	139
13.10	UNI Access Link Ingress Bandwidth Profile Envelope Service Attribute.....	140
13.11	UNI Access Link Egress Bandwidth Profile Envelope Service Attribute.....	140
13.12	UNI Access Link Reserved VRIDs Service Attribute.....	141
<b>14</b>	<b>ENNI Service Attributes.....</b>	<b>142</b>
14.1	ENNI Identifier Service Attribute .....	142
14.2	ENNI Type Service Attribute .....	142
14.3	ENNI Routing Information Service Attribute .....	143
14.3.1	ENNI Routing Protocols for Option A.....	143
14.4	ENNI Ingress Bandwidth Profile Envelopes Service Attribute.....	145
14.5	ENNI Egress Bandwidth Profile Envelopes Service Attribute .....	146
<b>15</b>	<b>ENNI Common Attributes .....</b>	<b>148</b>
15.1	ENNI Peering Identifier Common Attribute .....	148
15.2	ENNI Peering Type Common Attribute.....	149
15.3	ENNI List of ENNI Links Common Attribute .....	149
15.3.1	L1 Link Identifier.....	149
15.3.2	L1 Technology .....	150
15.3.3	List of ENNI Links.....	152
15.3.4	Example.....	152
15.4	ENNI List of Control Protocols Common Attribute .....	153
15.5	ENNI Routing Protocols Common Attribute .....	154

15.5.1 ENNI Routing Protocols for Option A.....	154
15.6 ENNI Service Map Common Attribute.....	157
15.6.1 ENNI Service Map for Option A .....	158
<b>16 ENNI Link Attributes.....</b>	<b>161</b>
16.1 ENNI Link Identifier Attribute.....	161
16.2 ENNI Link L2 Technology Attribute .....	161
16.3 ENNI Link IPv4 Connection Addressing Attribute .....	162
16.4 ENNI Link IPv6 Connection Addressing Attribute .....	163
16.5 ENNI Link BFD Attribute.....	164
16.6 ENNI Link IP MTU Attribute .....	166
<b>17 Bandwidth Profiles.....</b>	<b>168</b>
17.1 Structure of Bandwidth Profiles .....	168
17.2 Bandwidth Profile Flows .....	169
17.3 Bandwidth Profile Envelopes .....	174
17.4 Bandwidth Profile Behavior .....	176
17.4.1 Packet Bursts.....	179
17.4.2 Ingress Bandwidth Profiles .....	180
17.4.3 Egress Bandwidth Profiles .....	180
<b>18 References.....</b>	<b>182</b>
<b>Appendix A Using RFC 8299 for MEF IP Services (Informative) .....</b>	<b>186</b>
A.1 Terminology Alignment .....	187
A.2 Representing MEF IP Services.....	188
A.3 IPVC Service Attributes .....	190
A.4 IPVC End Point Service Attributes .....	192
A.4.1 Class of Service Classification.....	194
A.5 UNI Service Attributes .....	195
A.6 UNI Access Link Service Attributes .....	199
A.7 ENNI Service Attributes and ENNI Common Attributes .....	205
A.8 ENNI Link Attributes .....	210
A.9 Bandwidth Profiles .....	213
<b>Appendix B Examples for Subscriber IP Services (Informative) .....</b>	<b>216</b>
B.1 Multiple Subscriber Networks.....	216
B.2 Packet Delivery with Multiple Subscriber IPVCs.....	218
B.3 Packet Delivery with an Extranet .....	224
B.4 Packet Delivery with Multiple UNIs .....	229
B.5 Class of Service Examples .....	232
B.5.1 Ingress CoS Map Examples .....	232
B.5.2 Class of Service Handling with DSCP Preservation.....	234
B.5.3 Class of Service Handling with an Egress CoS Map .....	236
B.6 SLS Examples.....	238
B.7 Bandwidth Profile and Traffic Shaping Examples .....	240
B.7.1 Bandwidth Profile Use Cases.....	240
B.7.2 Bandwidth Profile with Multiple IPVC EPs .....	242
B.7.3 Bandwidth Profile Implementation .....	244

---

B.8	Subscriber Provided Access .....	248
<b>Appendix C</b>	<b>Implementation Examples for Subscriber IP Services (Informative) .....</b>	<b>251</b>
C.1	Multipoint Subscriber IPVC Example.....	251
C.2	Rooted Multipoint IPVC Example .....	266
C.3	Internet Access Example .....	270
<b>Appendix D</b>	<b>Examples for Operator IP Services (Informative) .....</b>	<b>275</b>
D.1	Use Cases.....	275
D.1.1	Access to a Single Remote UNI.....	275
D.1.2	Access to Multiple Remote UNIs.....	277
D.1.3	Multiple Services at an ENNI .....	278
D.1.4	Multiple Services at a Single Remote UNI .....	280
D.1.5	Access to a Remote Managed CPE .....	282
D.2	Use of AS Override at an ENNI .....	283
<b>Appendix E</b>	<b>Using Ethernet Access to Implement IP Services (Informative) .....</b>	<b>286</b>
<b>Appendix F</b>	<b>Implementation Examples for Operator IP Services (Informative).....</b>	<b>290</b>
F.1	Multipoint IPVC Example.....	290
<b>Appendix G</b>	<b>Changes from MEF 61 .....</b>	<b>310</b>

## List of Figures

Figure 1 – Subscriber IP Service connecting 3 Subscriber locations .....	10
Figure 2 – Subscriber IP Service providing access to a cloud service.....	11
Figure 3 – Examples of UNI Access Links in a Single UNI .....	14
Figure 4 – Example of UNIs and UNI Access Links.....	15
Figure 5 – Example of an IPVC and IPVC End Points .....	16
Figure 6 – Relationship of UNIs and IPVC EPs.....	17
Figure 7 – Subscriber-managed and Provider-managed CEs .....	19
Figure 8 – Example of Subscriber VPN services.....	21
Figure 9 – Extranet example .....	22
Figure 10 – Extranet Example showing IPVCs .....	23
Figure 11 – Internet Access Service .....	25
Figure 12 – Cloud Access Service .....	26
Figure 13 – Operator IP Services.....	30
Figure 14 – Operator IP Services with the SP acting as an Operator .....	31
Figure 15 – Example showing Operator IPVCs .....	33
Figure 16 – Example of Hierarchical Operator IP Services .....	35
Figure 17 – Example of two IP Services across an ENNI .....	39
Figure 18 – Example of ENNI Service Mapping Identifiers for IP Services across an ENNI.....	40
Figure 19 – Example of a Rooted Multipoint IPVC across an ENNI.....	42
Figure 20 – Example of a Rooted Multipoint IPVC across an ENNI with Trunk IPVC EPs .....	43
Figure 21 – Routing Information Databases at a UNI (IPVC EPs with <i>Root</i> role) .....	49
Figure 22 – Routing Information Databases at an ENNI.....	50
Figure 23 – IP Packet Delivery overview .....	52
Figure 24 – Selecting an Ingress IPVC EP .....	54
Figure 25 – Example of a Bump-in-the-Wire Service .....	61
Figure 26 – Example of SLS specified using locations .....	73
Figure 27 – Impact of SLS reference locations .....	74
Figure 28 – UNI Access Link using VRRP .....	126
Figure 29 – DHCPv6 Prefix Delegation .....	135
Figure 30 – Example for ENNI Service Map .....	159
Figure 31 – Example of Multiple Subscriber Networks – Logical View .....	216
Figure 32 – Example of Multiple Subscriber Networks – Physical Topology.....	217
Figure 33 – Example of Multiple Subscriber Networks – Setup at one Location .....	218
Figure 34 – Example IP Service .....	219
Figure 35 – Example IP Service Showing Three IPVCs .....	220
Figure 36 – Example IP Service – Subnets and Prefix Mapping.....	221
Figure 37 – Example IP Service – Reachable Prefixes.....	222
Figure 38 – Example IP Service – Per-IPVC EP Routing.....	222
Figure 39 – Example IP Service – Combined Routing.....	224
Figure 40 – Extranet Example showing IPVCs .....	225
Figure 41 – Extranet Example showing IP Prefixes .....	226
Figure 42 – Extranet Example showing Routing Information Databases.....	228
Figure 43 – Extranet Example showing Routing Tables .....	229
Figure 44 – Example IP Service .....	230
Figure 45 – Example IP Service showing IPVCs .....	231



Figure 46 – Example with DSCP Preservation.....	235
Figure 47 – Example with DSCP Preservation showing Service Attributes .....	235
Figure 48 – Example with DSCP Preservation showing packet handling.....	236
Figure 49 – Example of an Egress CoS Map.....	237
Figure 50 – Example of an Egress CoS Map showing Service Attributes .....	237
Figure 51 – Example of an Egress CoS Map showing packet handling .....	238
Figure 52 – Example SLS using IPVC EPs .....	239
Figure 53 – Example SLS using Locations.....	240
Figure 54 – Bandwidth Profile Example for an IP VPN Service .....	241
Figure 55 – Bandwidth Profile Example for an Internet Access Service .....	242
Figure 56 – Bandwidth Profile Example with Multiple IPVC EPs .....	243
Figure 57 – Example Traffic Conditioning Location for a Single IPVC.....	245
Figure 58 – Example per-IPVC Traffic Conditioning Location for Multiple IPVCs.....	246
Figure 59 – Example per-UNI Traffic Conditioning Location for Multiple IPVCs.....	247
Figure 60 – Example Traffic Conditioning Location for a Provider-Managed CE.....	248
Figure 61 – Example of Subscriber Provided Access.....	249
Figure 62 – SP Co-location Facility .....	250
Figure 63 – Example Multipoint IP VPN .....	252
Figure 64 – Example Cloud Access IPVC for Internet Access .....	270
Figure 65 – Access to a Single Remote UNI .....	276
Figure 66 – Access to Multiple Remote UNIs.....	278
Figure 67 – Multiple Services at an ENNI.....	279
Figure 68 – Multiple Services at a Single Remote UNI .....	281
Figure 69 – Operator Transit Service Connecting an SP Managed CPE.....	282
Figure 70 – Example of AS Override at an ENNI.....	284
Figure 71 – Example Subscriber IP Service .....	286
Figure 72 – Using an Ethernet Service to Connect a Remote UNI .....	287
Figure 73 – Access E-Line connecting to an IP Service.....	288
Figure 74 – IP Layer view of the Ethernet Access Service. ....	289
Figure 75 – Example Multipoint IP VPN .....	291
Figure 76 – Example Operator Services used for a Multipoint IP VPN.....	292
Figure 77 – Example Operator Services used for a Multipoint IP VPN.....	308

## List of Tables

Table 1 – Terminology and Abbreviations .....	6
Table 2 – Numerical Prefix Conventions.....	7
Table 3 – IPVC Service Attributes .....	63
Table 4 – Parameters for One-way Packet Delay Percentile .....	77
Table 5 – Parameters for One-way Mean Packet Delay .....	78
Table 6 – Parameters for One-way Inter-Packet Delay Variation .....	79
Table 7 – Parameters for One-way Packet Delay Range.....	80
Table 8 – Parameters for One-way Packet Loss Ratio .....	81
Table 9 – Parameters for Service Uptime .....	82
Table 10 – Subscriber IPVC Cloud Service Attribute parameters .....	86
Table 11 – Values for the Cloud Ingress Class of Service Map .....	87
Table 12 – Matching Criteria for the Cloud Ingress Class of Service Map.....	88
Table 13 – IPVC EP Service Attributes.....	94
Table 14 – Values for the IPVC EP Ingress Class of Service Map .....	104
Table 15 – Matching Criteria for the IPVC EP Ingress Class of Service Map.....	105
Table 16 – UNI Service Attributes .....	109
Table 17 – Example value of the UNI List of Control Protocols Service Attribute .....	112
Table 18 – Example value of the UNI List of Control Protocols Service Attribute .....	113
Table 19 – Examples of IP Control Protocols .....	114
Table 20 – UNI Access Link Service Attributes .....	123
Table 21 – ENNI Service Attributes .....	142
Table 22 – ENNI Common Attributes .....	148
Table 23 – Examples of L1 Technologies .....	152
Table 24 – Example value of the ENNI List of Control Protocols Common Attribute.....	153
Table 25 – Example value of the ENNI Service Map Common Attribute .....	160
Table 26 – Attribute Summary for ENNI Service Map Example.....	160
Table 27 – ENNI Link Attributes .....	161
Table 28 – BWP Flow Criteria and Parameters.....	173
Table 29 – Bandwidth Profile Parameters for a Bandwidth Profile Flow .....	175
Table 30 – Example of BWP Flow Parameters .....	178
Table 31 – Terminology Comparison with RFC 8299 .....	188
Table 32 – IPVC Service Attributes Comparison with RFC 8299 .....	192
Table 33 – IPVC EP Service Attributes Comparison with RFC 8299 .....	194
Table 34 – Comparison of Fields for Class of Service Map.....	195
Table 35 – UNI Service Attributes Comparison with RFC 8299 .....	199
Table 36 – UNI Access Link Service Attributes Comparison with RFC 8299 .....	205
Table 37 – ENNI Service Attributes Comparison with RFC 8299.....	206
Table 38 – ENNI Common Attributes Comparison with RFC 8299.....	210
Table 39 – ENNI Link Attributes Comparison with RFC 8299 .....	212
Table 40 – Representing Envelope MaxIR using QoS Profiles.....	214
Table 41 – Bandwidth Profile Flow Parameter Comparison with RFC 8299 .....	215
Table 42 – Selected Service Attributes for an Extranet.....	227
Table 43 – Example BWP Flow Parameters for Multiple IPVC EPs.....	244
Table 44 – Example of Subscriber IPVC Service Attributes for a Multipoint IP VPN.....	254
Table 45 – Example of UNI Service Attributes for the London UNI.....	256

Table 46 – Example of UNI Access Link Service Attributes for the London UNI.....	258
Table 47 – Example of IPVC EP Service Attributes at the London UNI.....	258
Table 48 – Example of UNI Service Attributes for the Tokyo UNI.....	260
Table 49 – Example of UNI Access Link Service Attributes for the Tokyo UNI.....	260
Table 50 – Example of IPVC EP Service Attributes at the Tokyo UNI.....	261
Table 51 – Example of UNI Service Attributes for the San Francisco UNI.....	263
Table 52 – Example of UNI Access Link Service Attributes for the San Francisco UNI (Link 1) .....	264
Table 53 – Example of UNI Access Link Service Attributes for the San Francisco UNI (Link 2) .....	265
Table 54 – Example of IPVC EP Service Attributes at the San Francisco UNI.....	266
Table 55 – Example of Subscriber IPVC Service Attributes for a Rooted Multipoint IP VPN.	267
Table 56 – Example of IPVC EP Service Attributes at the London UNI for Rooted Multipoint .....	268
Table 57 – Example of IPVC EP Service Attributes at the Tokyo UNI for Rooted Multipoint	269
Table 58 – Example of IPVC EP Service Attributes at the San Francisco UNI for Rooted Multipoint .....	270
Table 59 – Example of Subscriber IPVC Service Attributes for a Cloud Access IPVC .....	271
Table 60 – Example of UNI Service Attributes for a Cloud Access service .....	272
Table 61 – Example of UNI Access Link Service Attributes for a Cloud Access Service .....	273
Table 62 – Example of IPVC EP Service Attributes for a Cloud Access service .....	274
Table 63 – ENNI Common Attribute Values .....	293
Table 64 – Example of Subscriber IPVC Service Attributes for a Multipoint IP VPN.....	294
Table 65 – Example of UNI Service Attributes for the San Francisco UNI.....	295
Table 66 – Example of UNI Access Link Service Attributes for the San Francisco UNI (Link 1) .....	296
Table 67 – Example of UNI Access Link Service Attributes for the San Francisco UNI (Link 2) .....	297
Table 68 – Example of IPVC EP Service Attributes at the San Francisco UNI.....	297
Table 69 – Example of ENNI Service Attributes .....	298
Table 70 – Example of IPVC EP Service Attributes at the ENNI.....	298
Table 71 – Example of Subscriber IPVC Service Attributes for a Multipoint IP VPN.....	300
Table 72 – Example of UNI Service Attributes for the London UNI.....	300
Table 73 – Example of UNI Access Link Service Attributes for the London UNI.....	301
Table 74 – Example of IPVC EP Service Attributes at the London UNI.....	302
Table 75 – Example of UNI Service Attributes for the Tokyo UNI.....	302
Table 76 – Example of UNI Access Link Service Attributes for the Tokyo UNI.....	303
Table 77 – Example of IPVC EP Service Attributes at the Tokyo UNI.....	303
Table 78 – Example of ENNI Service Attributes .....	304
Table 79 – Example of IPVC EP Service Attributes at the ENNI.....	304
Table 80 – ENNI Link Attribute Values for ENNI Link 1 .....	305
Table 81 – ENNI Link Attribute Values for ENNI Link 2 .....	306
Table 82 – New ENNI Common Attribute Values .....	306
Table 83 – Summary of Attributes used in the Example .....	307

## 1 List of Contributing Members

The following members of the MEF participated in the development of this document and have requested to be included in this list.

- Amdocs
- Bell Canada
- Cisco
- Cox Communications
- Ericsson
- Infinera
- Spirent
- Telus
- Zayo
- ZTE

## 2 Abstract

This document specifies the Service Attributes that need to be agreed between a Service Provider and a Subscriber for IP Services, including IP VPNs, cloud access<sup>1</sup> and Internet access. It further specifies the Service Attributes that need to be agreed between a Service Provider and an Operator when part of an end-to-end IP Service needs to be implemented by a partner Operator. Some key concepts are introduced, including IP UNIs, IP ENNIs, IP Virtual Connections, IP Virtual Connection End Points, IP UNI Access Links and IP ENNI Links. Specific Service Attributes and corresponding behavioral requirements are defined for each of these entities. These include support for assured services, e.g. multiple Classes of Service, performance objectives specified in a Service Level Specification, and Bandwidth Profiles.

---

<sup>1</sup> Private cloud access is deferred to a future revision of this document.

### 3 Terminology and Abbreviations

This section defines the terms used in this document. In many cases, the normative definitions to terms are found in other documents. In these cases, the third column is used to provide the reference that is controlling, in other MEF or external documents.

Note: Terms marked with \* are adapted from terms in MEF 4 [63], MEF 10.4 [64], MEF 23.2 [65] and MEF 26.2 [66], to ensure they apply generically to IP or Ethernet services.

Term	Definition	Reference
<b>Bandwidth Profile</b>	A specification of the temporal properties of a sequence of IP Packets at an EI, along with rules for determining the level of conformance to the specification for each IP Packet in the sequence.	This document *
<b>Bandwidth Profile Envelope</b>	A set of one or more Bandwidth Profile Flows, and corresponding parameters, that are associated such that the amount of traffic for one flow can affect the amount that is permitted for another flow.	This document
<b>Bandwidth Profile Flow</b>	A stream of IP Packets that meet certain criteria.	This document *
<b>BWP Envelope</b>	Bandwidth Profile Envelope.	This document
<b>BWP Flow</b>	Bandwidth Profile Flow.	This document
<b>CE</b>	Customer Edge.	RFC 4364 [31]
<b>Class of Service Name</b>	An administrative name assigned to a particular set of performance objectives, and related Bandwidth Profiles.	This document *
<b>Cloud Provider</b>	A person, organization or entity responsible for making cloud services available to Subscribers.	MEF 47 [68]
<b>CoS Name</b>	Class of Service Name. For the avoidance of doubt, note that in this document, the term “CoS” does not refer to the Ethernet Priority Code Point (PCP) field.	This document
<b>Customer Edge</b>	Physical or Virtual Equipment that is dedicated to a particular Subscriber and is directly adjacent (at Layer 3) to one or more PE devices. The CE might or might not be managed by the Subscriber.  <b>Note: this specification uses the IETF definition of Customer Edge that is common parlance in the context of IP. With this definition, the CE is the equipment that is directly adjacent (at Layer 3) to the PE, regardless of who owns and manages it. This is different to the definition of Customer Edge used in other MEF specifications.</b>	Adapted from RFC 4364 [31], RFC 8299 [59]
<b>Differentiated Services Field</b>	In an IP Packet, the six most significant bits of the (former) IPv4 Type Of Service (TOS) octet or the (former) IPv6 Traffic Class octet.	RFC 3260 [22]

<b>Term</b>	<b>Definition</b>	<b>Reference</b>
<b>DNS</b>	Domain Name System.	RFC 1034 [3]
<b>Domain Name System</b>	The system and infrastructure for mapping between IP addresses and domain names.	RFC 1034 [3]
<b>DS Field</b>	Differentiated Services Field.	RFC 3260 [22]
<b>Egress IP Packet</b>	An IP Packet transmitted towards the Subscriber Network at a UNI or towards another Operator Network at an ENNI.	This document
<b>EI</b>	External Interface.	This document *
<b>ENNI</b>	External Network Network Interface.	This document *
<b>ENNI Service Mapping Context</b>	A pair of (SP/SO name, ENNI Service Mapping Identifier).	This document
<b>ENNI Service Mapping Identifier</b>	An Identifier assigned by a SP/SO and used to map an IPVC EP on one side of an ENNI to an IPVC EP on the other side of an ENNI, so as to realize the SP/SO's end-to-end service.	This document
<b>External Network Network Interface</b>	The demarcation point marking the boundary of responsibility between two Operators whose networks are operated as separate administrative domains. In this document, "External Network Network Interface" should be read as meaning "IP External Network Network Interface".	This document *
<b>External Interface</b>	Either a UNI or an ENNI. In this document, "External Interface" should be read as meaning "IP External Interface".	This document *
<b>Ingress IP Packet</b>	An IP Packet received from the Subscriber Network at a UNI or from another Operator Network at an ENNI.	This document
<b>Internet Protocol</b>	A protocol for transmitting blocks of data from source to destination hosts within an interconnected system of packet-switched computer communication networks.	RFC 791 [1]
<b>IP</b>	Internet Protocol.	RFC 791 [1]
<b>IP Attachment Circuit</b>	A means of connecting a CE and a PE at Layer 3, such that they are Layer 3 peers (i.e. over a single IP hop).	RFC 4364 [31]
<b>IP Control Protocol Packet</b>	An IP Packet traversing an EI that is identified as belonging to a control protocol used between the Subscriber and the SP or Operator (at a UNI) or between two Operators (at an ENNI), e.g. a routing protocol or OAM protocol.	This document
<b>IP Data Packet</b>	An IP Packet traversing an EI that is not an IP Control Protocol Packet.	This document
<b>IP External Interface</b>	An EI at which an IP Service is accessed.	This document
<b>IP External Network Network Interface</b>	An ENNI at which an IP Service is accessed.	This document
<b>IP Operator</b>	An Operator for an IP Service.	This document

<b>Term</b>	<b>Definition</b>	<b>Reference</b>
<b>IP Packet</b>	Either an IPv4 Packet or an IPv6 Packet, from the start of the IP Version field to the end of the IP data field.	RFC 791 [1], RFC 8200 [57]
<b>IP Prefix</b>	A set of IP addresses, containing the contiguous range of IP addresses whose initial <i>n</i> bits all have the same value, for some value of <i>n</i> . Typically this is expressed by giving the first address in the range and the value of <i>n</i> (the “prefix length”).	This document
<b>IP Service</b>	A connectivity service that carries IP Packets irrespective of the underlying Layer 2 technology, and that is specified using Service Attributes as defined in a MEF Specification.	This document
<b>IP Service Provider</b>	A Service Provider for an IP Service.	This document
<b>IP Subscriber</b>	A Subscriber of an IP Service.	This document
<b>IP Subscriber Network</b>	A Subscriber Network connected to the SP via IP UNIs.	This document
<b>IP UNI Access Link</b>	A UNI Access Link for an IP Service, i.e. a subnetwork corresponding to a distinct IP subnet, that forms part of a UNI. The subnet might use both IPv4 and IPv6 addressing.	This document
<b>IP User Network Interface</b>	A UNI at which an IP Service is accessed.	This document
<b>IP Virtual Connection</b>	An association of two or more IPVC EPs that limits the exchange of IP Packets to IPVC EPs for the IPVC.	This document
<b>IPv4</b>	IP version 4.	RFC 791 [1]
<b>IPv6</b>	IP version 6.	RFC 8200 [57]
<b>IPVC</b>	IP Virtual Connection.	This document
<b>IPVC End Point</b>	A logical entity at a given External Interface to which a distinct subset of IP Packets passing over that External Interface is mapped.	This document
<b>IPVC EP</b>	IPVC End Point.	This document
<b>L1 .. L7</b>	Layer 1 .. 7.	ISO OSI [70]
<b>Layer 1 .. 7</b>	The layers of the ISO OSI model.	ISO OSI [70]
<b>LLO</b>	Lowest Level Operator.	This document
<b>Lowest Level Operator</b>	The Operator of an Operator IP Service that is not decomposed into further Operator IP Services.	This document
<b>Operator</b>	An organization with administrative control over a network, and which provides wholesale services to other Operators or to Service Providers. In this document, “Operator” should be read as meaning “IP Operator”.	This document *
<b>Operator IPVC</b>	An IPVC used to provide an Operator IP Service.	This document

<b>Term</b>	<b>Definition</b>	<b>Reference</b>
<b>Operator IP Service</b>	A wholesale IP Service that is provided by an Operator to another Operator or a Service Provider, between 2 or more EIs, specified using the Service Attributes described in this document.	This document
<b>Operator Network</b>	An interconnected network used by an Operator to provide services to one or more Service Providers or other Operators.	This document
<b>PE</b>	Provider Edge.	RFC 4364 [31]
<b>Performance Metric</b>	One of a number of performance-related properties of an IPVC, that can be measured and for which objectives can be specified in an SLS.	This document
<b>Provider Edge</b>	Physical or Virtual Equipment that the SP is responsible for, that can support multiple IP Services for different customers, and is directly adjacent (at Layer 3) to one or more CE devices. The PE is logically part of the SP Network and is managed by the SP.	Adapted from RFC 4364 [31], RFC 8299 [59]
<b>Service Attribute</b>	Specific information agreed between the provider and the user of a service, as described in a MEF specification, that describes some aspect of the service behavior.	This document
<b>Service Level Agreement</b>	The contract between the Subscriber and Service Provider specifying the service level commitments and related business agreements for a service.	This document *
<b>Service Level Specification</b>	The technical details of the service level, in terms of performance objectives, agreed between the Service Provider and the Subscriber as part of the SLA.	This document *
<b>Service Provider</b>	An organization that provides services to Subscribers. In this document, “Service Provider” should be read as meaning “IP Service Provider”.	This document *
<b>Service Provider Network</b>	An interconnected network used by the Service Provider to provide services to one or more Subscribers.	This document
<b>SLA</b>	Service Level Agreement.	This document
<b>SLS</b>	Service Level Specification.	This document
<b>SLS-RP</b>	SLS Reference Point.	This document
<b>SLS Reference Point</b>	A point from or to which performance objectives are specified as part of an SLS; either an IPVC End Point or a location specified in the SLS Service Attribute.	This document
<b>SO</b>	Super Operator.	This document *
<b>SP</b>	Service Provider.	This document *
<b>SP/SO</b>	Service Provider or Super Operator; i.e. the user of an Operator IP Service.	This document *
<b>Subscriber</b>	The end-user of a service. In this document, “Subscriber” should be read as meaning “IP Subscriber”.	This document *
<b>Subscriber IPVC</b>	An IPVC used to provide a Subscriber IP Service.	This document



<b>Term</b>	<b>Definition</b>	<b>Reference</b>
<b>Subscriber IP Service</b>	An IP Service that is provided by a Service Provider to a Subscriber between two or more UNIs, or between one or more UNIs and a cloud service, specified using the Service Attributes described in this document.	This document
<b>Subscriber Network</b>	An interconnected network belonging to a given Subscriber, which is connected to the Service Provider at one or more UNIs. In this document, “Subscriber Network” should be read as meaning “IP Subscriber Network”.	This document
<b>Super Operator</b>	An Operator for an Operator IP Service that is decomposed into further Operator IP Services.	This document *
<b>Traffic Class</b>	An alternative term for Class of Service Name. In this document, Class of Service Name (CoS Name) is used. For the avoidance of doubt, note that in this document, the term “CoS” does not refer to the Ethernet Priority Code Point (PCP) field.	This document
<b>UNI</b>	User Network Interface.	This document *
<b>UNI Access Link</b>	An individual connection between the Subscriber and the SP that forms part of a UNI. In this document, “UNI Access Link” should be read as meaning “IP UNI Access Link”.	This document
<b>User Network Interface</b>	The demarcation point between the responsibility of the Service Provider and the responsibility of the Subscriber. In this document, “User Network Interface” should be read as meaning “IP User Network Interface”.	This document *

**Table 1 – Terminology and Abbreviations**

## 4 Compliance Levels

The key words "MUST", "MUST NOT", "REQUIRED", "SHALL", "SHALL NOT", "SHOULD", "SHOULD NOT", "RECOMMENDED", "NOT RECOMMENDED", "MAY", and "OPTIONAL" in this document are to be interpreted as described in BCP 14 (RFC 2119 [7], RFC 8174 [56]) when, and only when, they appear in all capitals, as shown here. All key words must be in bold text.

Items that are **REQUIRED** (contain the words **MUST** or **MUST NOT**) are labeled as [Rx] for required. Items that are **RECOMMENDED** (contain the words **SHOULD** or **SHOULD NOT**) are labeled as [Dx] for desirable. Items that are **OPTIONAL** (contain the words **MAY** or **OPTIONAL**) are labeled as [Ox] for optional.

## 5 Numerical Prefix Conventions

This document uses the prefix notation to indicate multiplier values as shown in Table 2.

Decimal		Binary	
Symbol	Value	Symbol	Value
k	$10^3$	Ki	$2^{10}$
M	$10^6$	Mi	$2^{20}$
G	$10^9$	Gi	$2^{30}$
T	$10^{12}$	Ti	$2^{40}$
P	$10^{15}$	Pi	$2^{50}$
E	$10^{18}$	Ei	$2^{60}$
Z	$10^{21}$	Zi	$2^{70}$
Y	$10^{24}$	Yi	$2^{80}$

Table 2 – Numerical Prefix Conventions

## 6 Introduction

IP Services have been widely deployed by Service Providers for many years, both in the form of the public Internet and in Virtual Private Networks (VPNs) – see IETF STD 5 [61] and RFC 4364 [31]. However, there is no standard framework that specifies how such services are described from the perspective of the user of the service. While Internet access is ubiquitous, Internet access services rarely provide any level of assured connectivity or performance. Even for VPN services, each Service Provider specifies their services in a different way, with respect to terminology, classes of service, service level agreements, etc. Furthermore, SPs might combine their VPN service with other value-added services (e.g., spam filtering), which can make comparison even more difficult, especially if such value-added services are at a different OSI layer.

For end users of IP Services, this makes selecting a Service Provider a very difficult task, as it is often impossible to compare service offerings from different providers when they use different terminology and specifications. Similarly, interactions between different Service Providers, in order to provide end-to-end services across different geographies, for example, are extremely challenging. Each Service Provider has to make a bilateral agreement with each Operator that it partners with, and has to map its internal terminology and methodology to that of each partner.

All of this means that service definition and activation, especially across multiple Operators, is extremely complex and consequently very hard to automate and orchestrate. This results in long lead times, leading to lack of service and higher costs for the Subscriber, and potential lost revenue for the Service Provider.

MEF has addressed similar issues for Ethernet services by creating a series of Ethernet service specifications that define standard terminology and standard attributes for describing Ethernet services. From these specifications, information models, data models and APIs can be created within the MEF LSO reference architecture. This allows for much easier orchestration and automation of Ethernet services. The same approach can also be applied for IP Services.

This document specifies Service Attributes for describing Subscriber and Operator IP Services. This document is consistent with IETF STD 5 [61].

IP Services are described using the Service Attributes specified in this document. Subscriber IP Services, i.e. those used by end users, include private cloud access, Internet access, and managed VPN services. Operator IP Services, i.e. those offered by one Operator to another Operator or Service Provider to help implement one of the above Subscriber IP Services, are also defined. Note this does not include Internet peering between ISPs.

This document focuses on services for unicast traffic. Multicast and broadcast traffic could be covered in a future revision. IPv4, IPv6 and “dual stack” services are supported.

The Service Attributes defined in this document can be used to support multiple redundant access links that connect a given Subscriber Network to the Service Provider. However, multiple redundant access links that connect to different Service Providers, as part of the same IP Service, are beyond the scope of this document. (A Subscriber can of course connect a given network to two different SPs by obtaining a separate IP Service from each of them).

The remainder of this document gives an overview of some key concepts (sections 7 and 8), details of routing and packet delivery in an IP Service (section 9), the specification of the Service Attributes for IP Services (sections 10 – 16), and details regarding Bandwidth Profiles (section 17). Appendix A compares this document to RFC 8299 [59]. Examples showing how to use various Service Attributes for Subscriber IP Services are in Appendix B and Appendix C, and for Operator IP Services in Appendix D and Appendix F. Appendix E describes how an Ethernet Access Service can be used to implement an IP Service. Appendix G describes the changes in this document compared to MEF 61.

In the main body of the document, informative notes, including on possible implementation choices, are given in *blue italic* type.

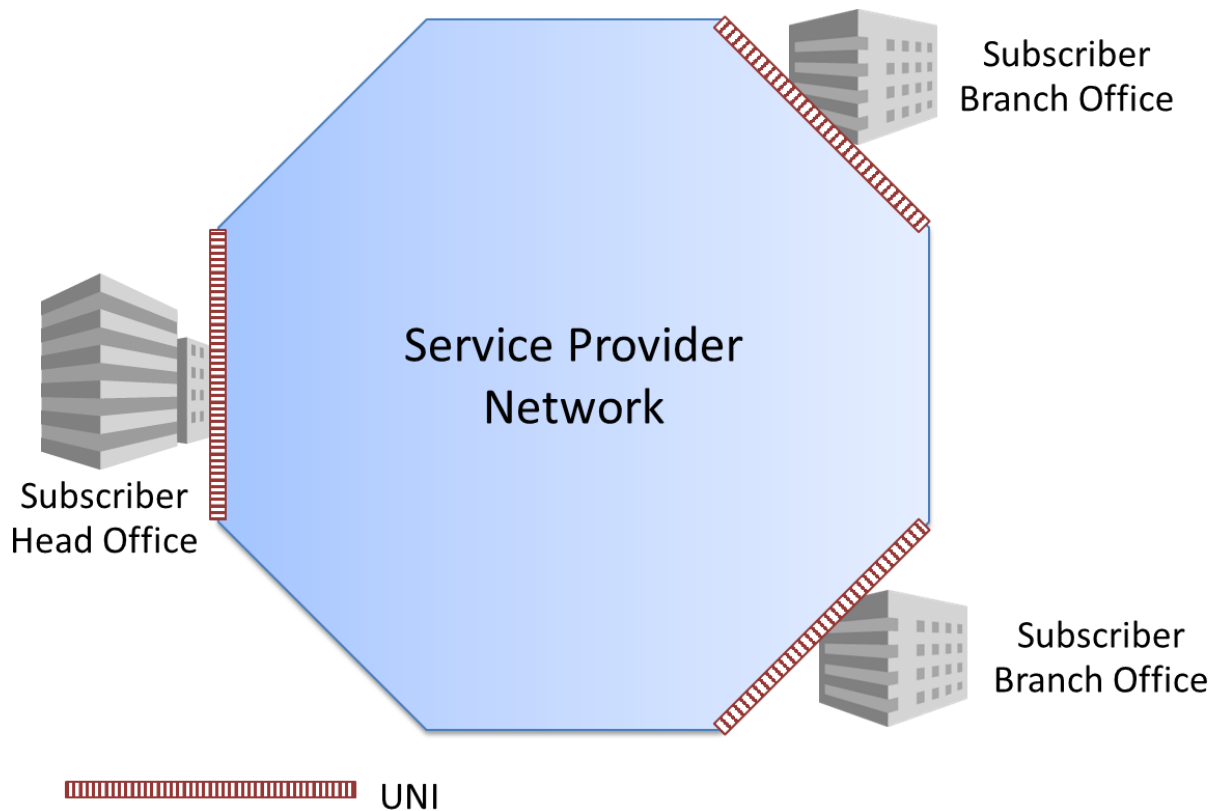
## 7 Key Concepts for Subscriber IP Services

This section explains some key concepts necessary for understanding Subscriber IP Services.

### 7.1 Subscriber IP Services

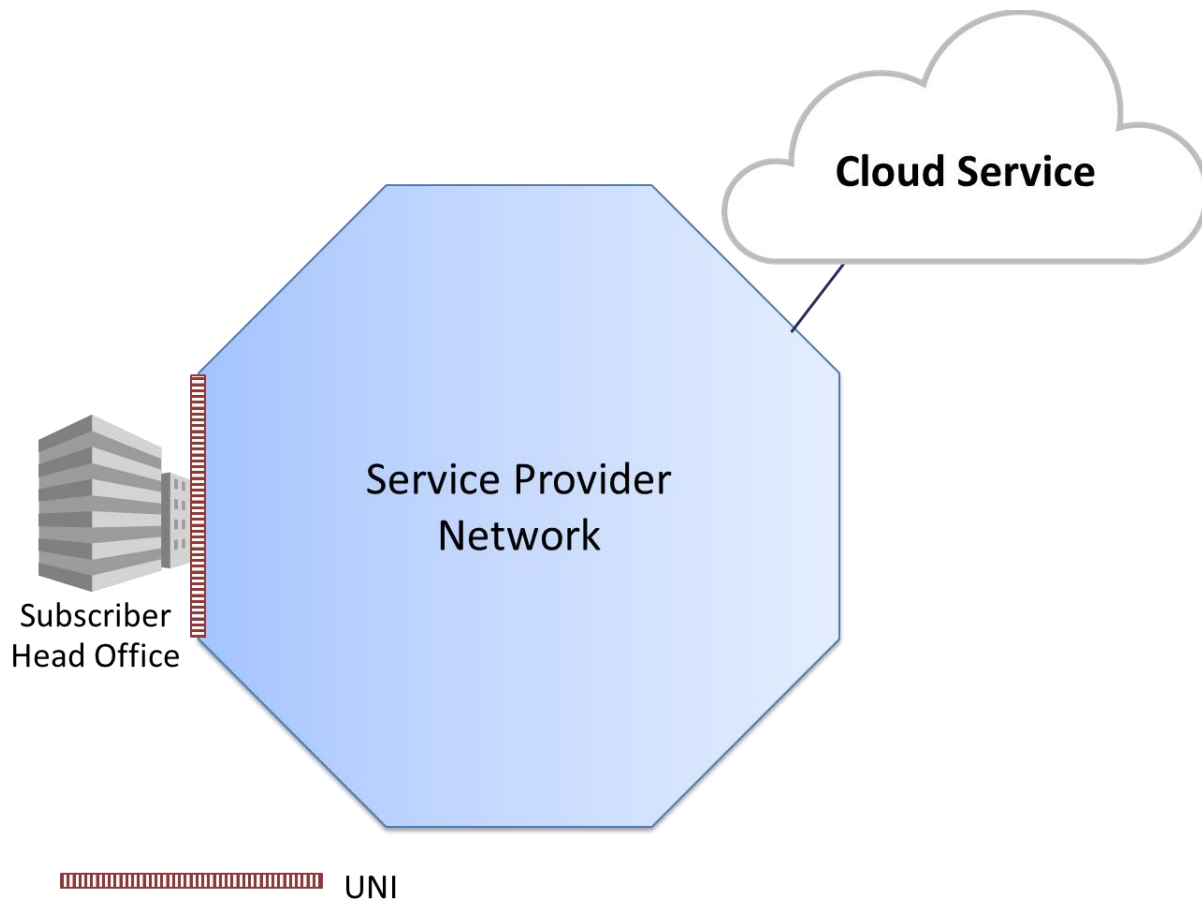
A Subscriber IP Service is an IP Service provided to an end user (the Subscriber) by a Service Provider. There is no restriction on the type of organization that can act as a Subscriber; for example, a Subscriber can be an enterprise, a mobile operator, an IT system integrator, a government department, etc. At its most basic, a Subscriber IP Service provides connectivity for IP Packets between different parts of the Subscriber’s network (usually at different physical locations) or between the Subscriber’s network and an external network, such as the public Internet or a private cloud service.

An example of a Subscriber IP Service connecting parts of the Subscriber’s network at 3 different locations is shown in Figure 1.



**Figure 1 – Subscriber IP Service connecting 3 Subscriber locations**

An example of a Subscriber IP Service connecting the Subscriber to a cloud service is shown in Figure 2.



**Figure 2 – Subscriber IP Service providing access to a cloud service**

Note that details regarding the interface between the SP and the provider of the cloud service are outside the scope of this document.

## 7.2 Service Attributes

MEF services are specified using Service Attributes. A Service Attribute captures specific information that is agreed between the provider and the user of a service, that describes some aspect of the service behavior. How such an agreement is reached is outside the scope of this document. Some examples of how agreement could be reached are given below, but this is not an exhaustive list.

- The provider of the service mandates a particular value.
- The user of the service selects from a set of options specified by the provider.
- The user of the service requests a particular value, and the provider indicates whether they accept it.
- The user and the provider of the service negotiate to reach a mutually acceptable value.

How the agreement is reached, and the specific values agreed, might have an impact on the price of the service or on other business or commercial aspects of the relationship between the provider and the user of the service; this is outside the scope of this document.

Service Attributes describe the externally visible behavior of the service; they do not constrain how the service is implemented by a Service Provider or Operator, or how the Subscriber implements their network.

Service Attributes for Subscriber IP Services are categorized as follows:

- IPVC Service Attributes (section 10).
- IPVC End Point Service Attributes (section 11).
- UNI Service Attributes (section 12).
- UNI Access Link Service Attributes (section 13).

Note: UNIs and UNI Access Links are described in section 7.3; IPVCs and IPVC End Points are described in section 7.4.

### 7.3 UNIs and UNI Access Links

A User Network Interface (UNI) is the demarcation point between the responsibility of the SP and the responsibility of the Subscriber. Note that a given UNI always relates to a single SP and a single Subscriber.

A Subscriber Network is an interconnected IP network belonging to a single Subscriber – different parts of a Subscriber Network can be connected to each other directly, or via a Subscriber IP Service obtained from a Service Provider. A Subscriber Network is connected to the Service Provider at one or more UNIs. A given UNI can only connect one Subscriber Network to the SP.

A given UNI consists of one or more distinct IP links, each of which is a single IP hop from a service perspective (i.e., there is no intermediate router that processes the IP Packets traversing the link). Each such IP link is known as a UNI Access Link, and is a subnetwork corresponding to a distinct IP subnet (which can have both IPv4 and IPv6 addressing). Some examples of UNI Access Links are as follows (this is not an exhaustive list):

- a distinct physical connection.
- a logical Layer 2 connection (for example, an Ethernet VLAN with a given VLAN ID). Such a Layer 2 connection might be over a single physical link, an aggregation of physical links (e.g. an Ethernet Link Aggregation Group) or an entire Layer 2 network (e.g. an Ethernet Switch or an Ethernet E-Access service).
- An IP tunnel (e.g. using GRE) over another IP network (e.g. over the Internet). In this case the UNI Access Link is the tunnel (which is a single IP hop), not the underlying IP network.

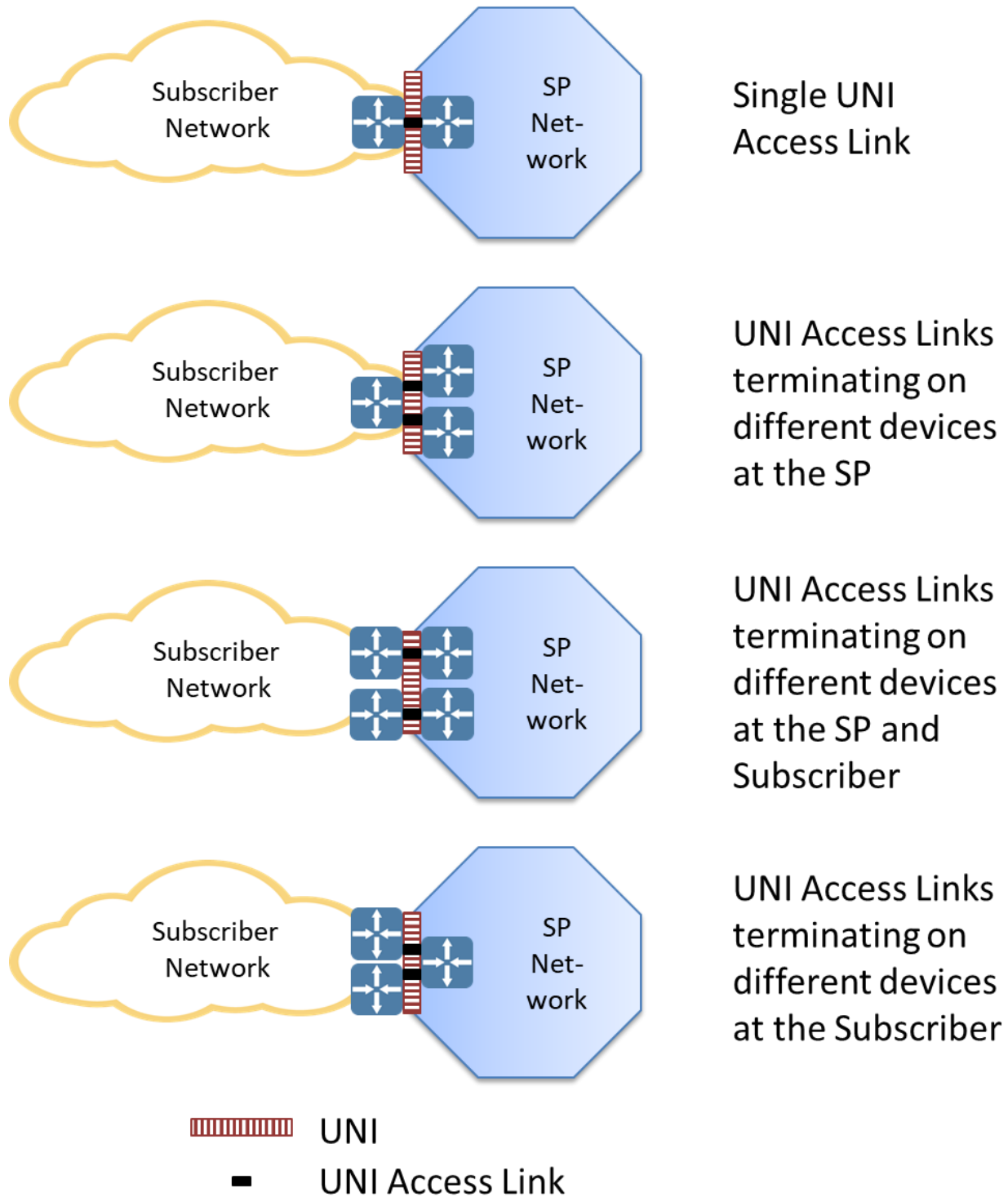
When a Subscriber Network is connected to an SP Network by a number of UNI Access Links, the Subscriber and SP need to agree how the UNI Access Links are grouped together to form UNIs (via the UNI List of UNI Access Links Service Attribute, section 12.3). Each UNI Access Link belongs to exactly one UNI.

This document does not constrain how UNI Access Links for a given Subscriber Network are grouped into UNIs. Typically, UNI Access Links that terminate at the same physical location in the Subscriber Network, and which have similar properties in terms of intended use, are grouped

into a single UNI. UNI Access Links that terminate at a remote physical location in the Subscriber Network, or which have a different intended use (such as for a backup link) are typically treated as separate UNIs. Note that the choice of how UNI Access Links are assigned to UNIs can affect how traffic is forwarded over them, as well as how assurance-related attributes such as Bandwidth Profiles and SLS performance objectives can be applied.

UNI Access Links in a given UNI can be connected to one or multiple devices at the Subscriber and at the Service Provider. Some examples are shown in Figure 3 – other arrangements are also possible. Note that the various examples shown can have different pros and cons; this document does not state a preference for any particular arrangement. Note also that the services to which the UNIs are connected are not shown.

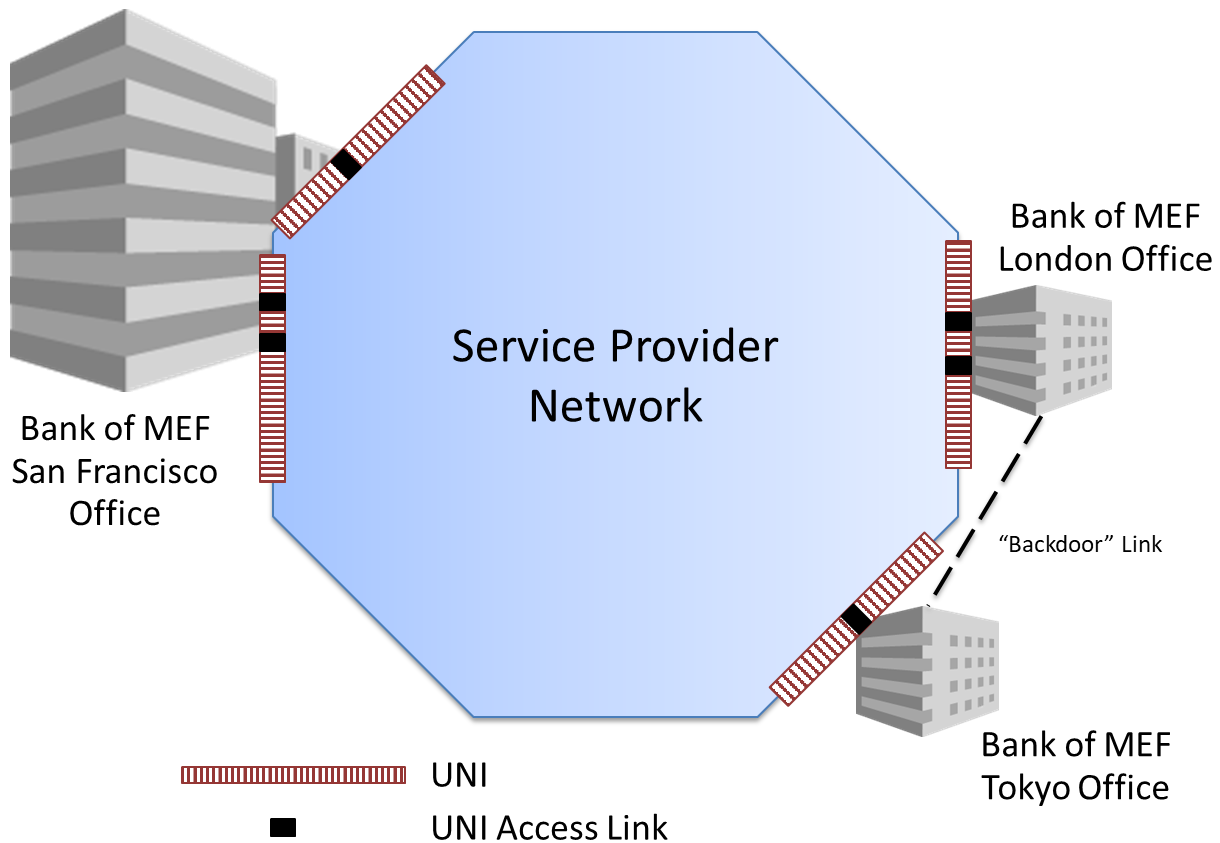




**Figure 3 – Examples of UNI Access Links in a Single UNI**

Figure 4 shows an example of a Subscriber, Bank of MEF, connecting to the SP in a variety of ways at different locations where they have offices. At the San Francisco office, Bank of MEF has three UNI Access Links. Two are grouped together in a single UNI, and these are used as the main connection to the SP and hence to the other parts of Bank of MEF’s Subscriber Network in

London and Tokyo. The third UNI Access Link is assigned to a separate UNI and is used as a backup link, i.e. traffic is only directed over this link when the main links fail (this can be achieved, for example, by setting routing protocol metrics appropriately). At the London office, there are two UNI Access Links grouped in a single UNI, and at the Tokyo office, there is a single UNI Access Link. There is also a “backdoor” link between the London and Tokyo offices, that is used as a backup when the main connection from either of those offices to the SP fails. The backdoor link is not part of the IP Service provided by the SP, but is shown to illustrate that there are no restrictions on how different parts of the Subscriber Network are connected to each other.



**Figure 4 – Example of UNIs and UNI Access Links**

It is possible for a Subscriber to have multiple independent Subscriber Networks. In this case, each Subscriber Network is connected to the Service Provider by distinct UNIs (which could share the same physical interface), that are attached to distinct IPVCs (see section 7.4).

As a UNI Access Link corresponds to a distinct IP link, it is also possible for multiple UNI Access Links to traverse the same physical medium, regardless of whether they belong to the same or different UNIs. For example, two UNI Access Links might be implemented as different VLANs on the same physical Ethernet link.

These two points are illustrated in the example in Appendix B.1.

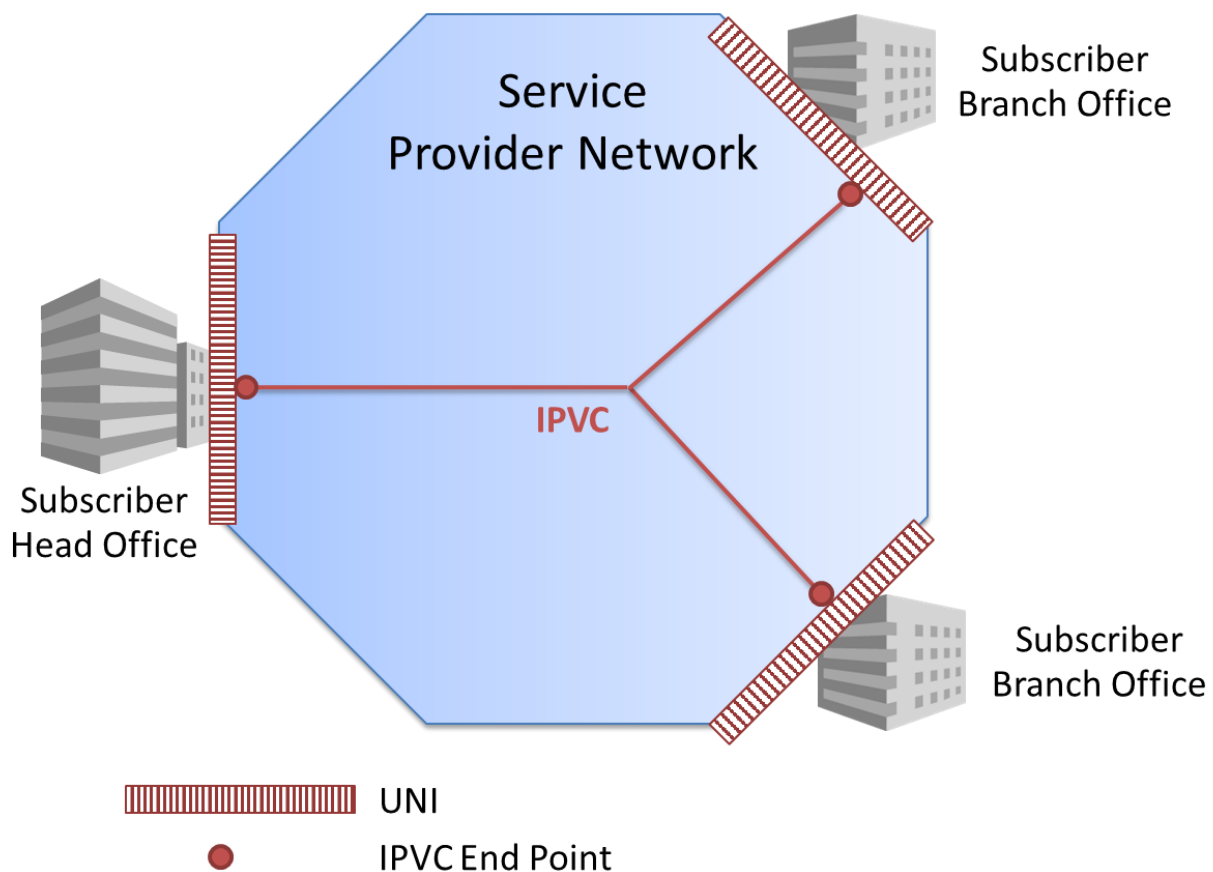
## 7.4 IP Virtual Connections and IPVC End Points

An IP Service is formed of an IP Virtual Connection (IPVC) that links together IPVC End Points at External Interfaces (EIs). In the case of a Subscriber IP Service, the IPVC End Points are specifically at UNIs. An IPVC End Point (IPVC EP) is a logical entity at an EI, to which a particular subset of packets that traverse the EI is mapped. The particular subset is identified by fields in the packet (typically the source IP address and/or destination IP address). Note that at a UNI, an IPVC EP is associated with the UNI as a whole, not with a particular UNI Access Link in the UNI. The subset of packets that are mapped to an IPVC EP is therefore independent of which UNI Access Link in the UNI the packets traverse. If it is desired to segregate traffic for different IPVCs on different UNI Access Links, then the UNI Access Links can be assigned to different UNIs.

If an IPVC has an IPVC EP at a given EI, we say that the EI is attached to the IPVC.

A Subscriber IPVC restricts the transmission of packets across the Service Provider Network to only those IPVC EPs that belong to the IPVC.

Figure 5 shows an example of an IPVC and IPVC EPs for a Subscriber:



**Figure 5 – Example of an IPVC and IPVC End Points**

Figure 6 shows a slightly more complex example with two Subscriber IPVCs. IPVC 1 connects the head office to two branch offices, and a separate IPVC (IPVC 2) with a stricter SLS connects

the head office to the data center. The view of the UNI on the left shows the relationship of UNIs, UNI Access Links, IPVCs and IPVC EPs. At this UNI, four UNI Access Links are shown. Independently, each of the two IPVCs has an IPVC EP at the UNI. Packets that arrive over any UNI Access Link are mapped to at most one of the IPVC EPs, depending on their destination addresses or other fields, as described in section 9. Note that packets that are mapped to different IPVC EPs might originate at the same device in the Subscriber Network, and hence have the same source IP address.

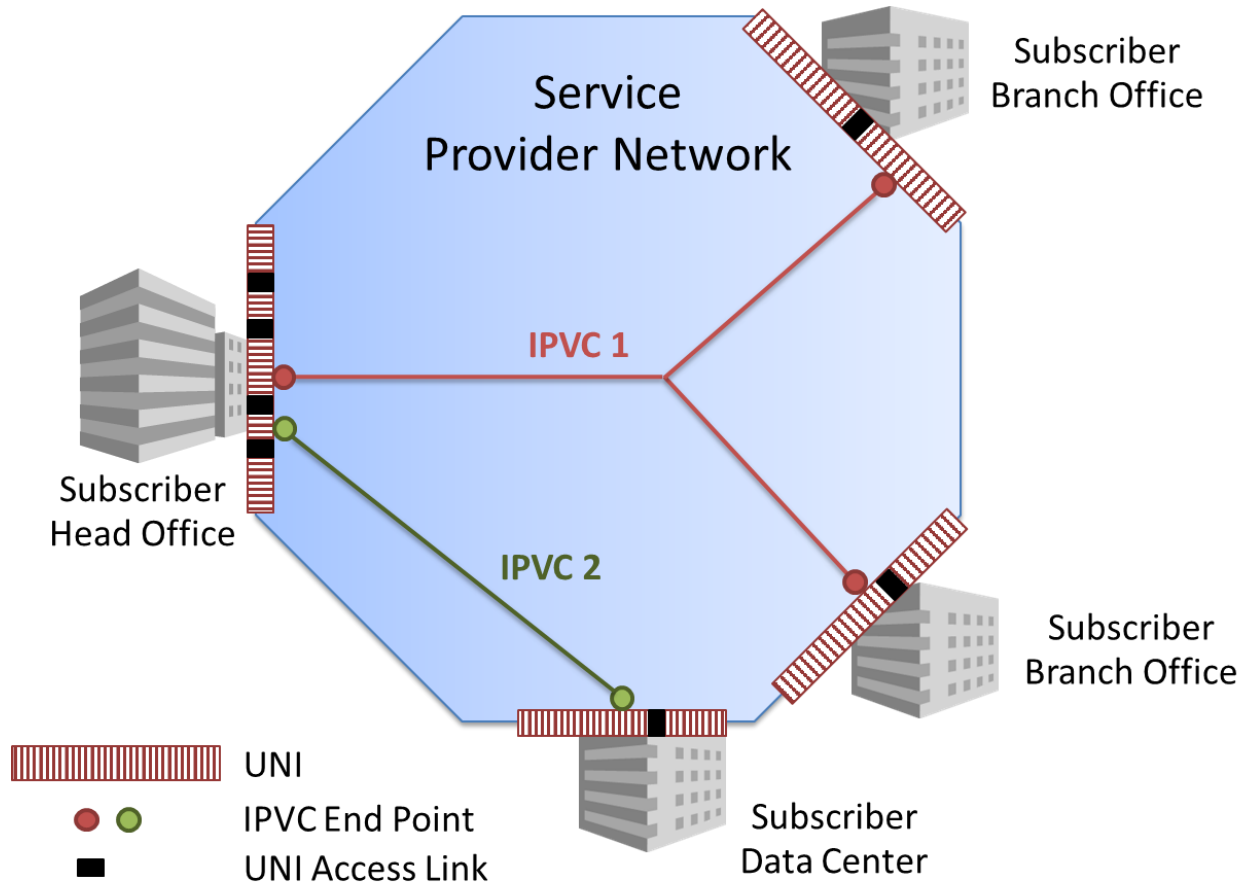


Figure 6 – Relationship of UNIs and IPVC EPs

### 7.5 Subscriber-Managed and Provider-Managed CEs

Implementation of an IP Service typically involves one or more Customer Edge (CE) devices and one or more Provider Edge (PE) devices for each Subscriber site. These devices can be physical or virtual. A physical CE device is dedicated to a single Subscriber, and in most cases only carries traffic for one Subscriber Network and is located at the Subscriber’s premises. A virtual CE device performs the same role but might not be located at the Subscriber’s premises. A PE device (physical or virtual) normally carries traffic for multiple Subscribers and is typically located at the SP’s premises.

**Note: this specification uses the IETF definition of CE that is common parlance in the context of IP. With this definition, the CE is the equipment that is directly adjacent (at Layer 3) to**

**the PE, regardless of who owns and manages it. This is different to the definition of Customer Edge used in other MEF specifications.**

There are two options for where the UNI and the CE device are placed with respect to each other. In the first option (originally defined in RFC 4364 [31]), the CE device is managed by the Subscriber, and the PE device is managed by the SP. In this case, the UNI (which is the demarcation point of responsibilities) is aligned with the IP Attachment Circuits between the PE and the CE – each IP Attachment Circuit corresponds to a UNI Access Link. This arrangement is known as a Subscriber-managed CE.

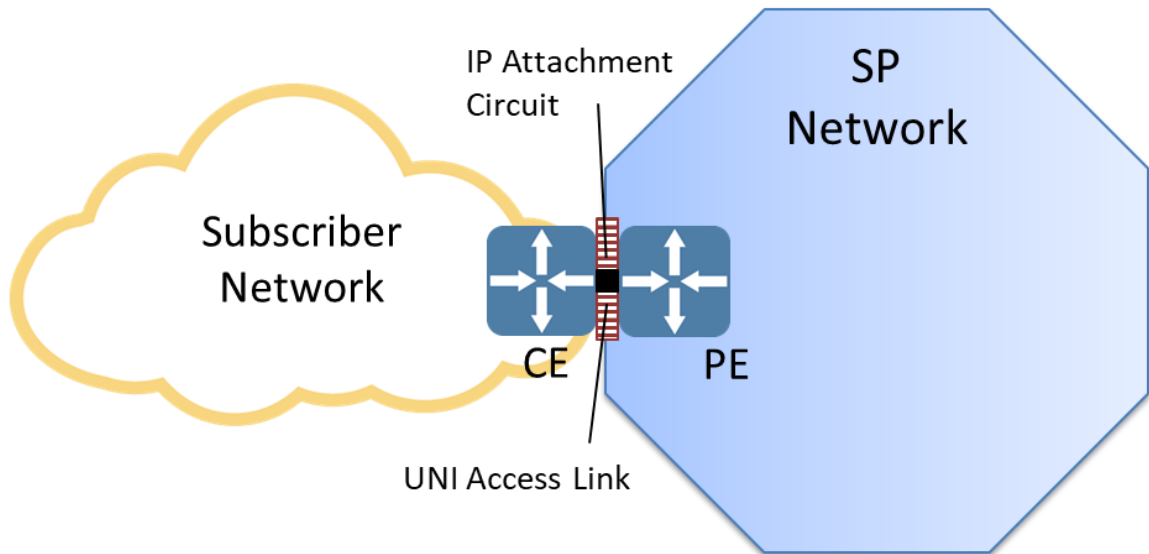
In the second option, which has also become popular, the SP manages the CE device (which is still typically located at the Subscriber's premises), and the Subscriber has their own router connected to the CE, or connects L3 end devices to it (directly or over an intervening L2 network)<sup>2</sup>. In this case, the UNI (the demarcation of responsibility) consists of UNI Access Links between the CE and the Subscriber's network or end stations; the IP Attachment Circuits between the CE and the PE are part of the SP's internal network in this case. This arrangement is known as a Provider-managed CE.

These two options are illustrated in Figure 7.

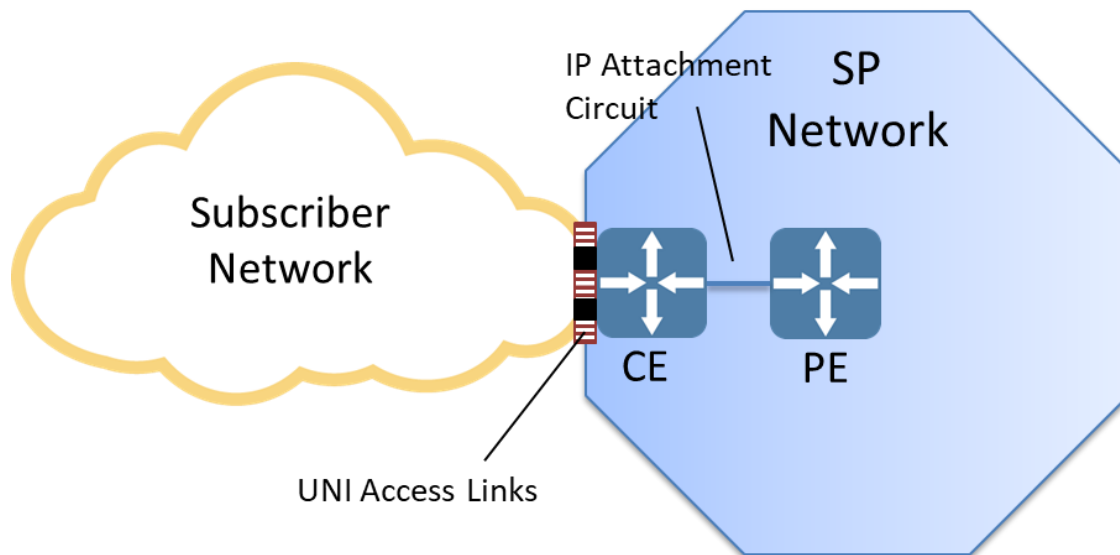
---

<sup>2</sup> In this case the CE is often referred to as a “managed router” or “managed CPE”.

## Subscriber-managed CE



## Provider-managed CE



**Figure 7 – Subscriber-managed and Provider-managed CEs**

Note that the location of the UNI with respect to the PE and CE devices is different in the two cases. Also, in the Provider-managed case, the IP Attachment Circuit and the CE are internal to

the SP Network. In the Subscriber-managed case, the SP might still place some equipment at the Subscriber premises, such as an L2 Network Interface Device (NID).

## 7.6 Service Assurance

Service Assurance is provided for MEF services via two mechanisms:

- A Service Level Specification (SLS), which sets out performance objectives for the service. Performance objectives can be specified for a variety of Performance Metrics, such as mean packet delay and packet loss ratio. Different objectives can be specified for different classes of service. See section 10.9.
- A set of Bandwidth Profiles, which specify the amount of traffic that the SP will accept at each UNI, and identify how much of that traffic is subject to the SLS objectives. See section 17.

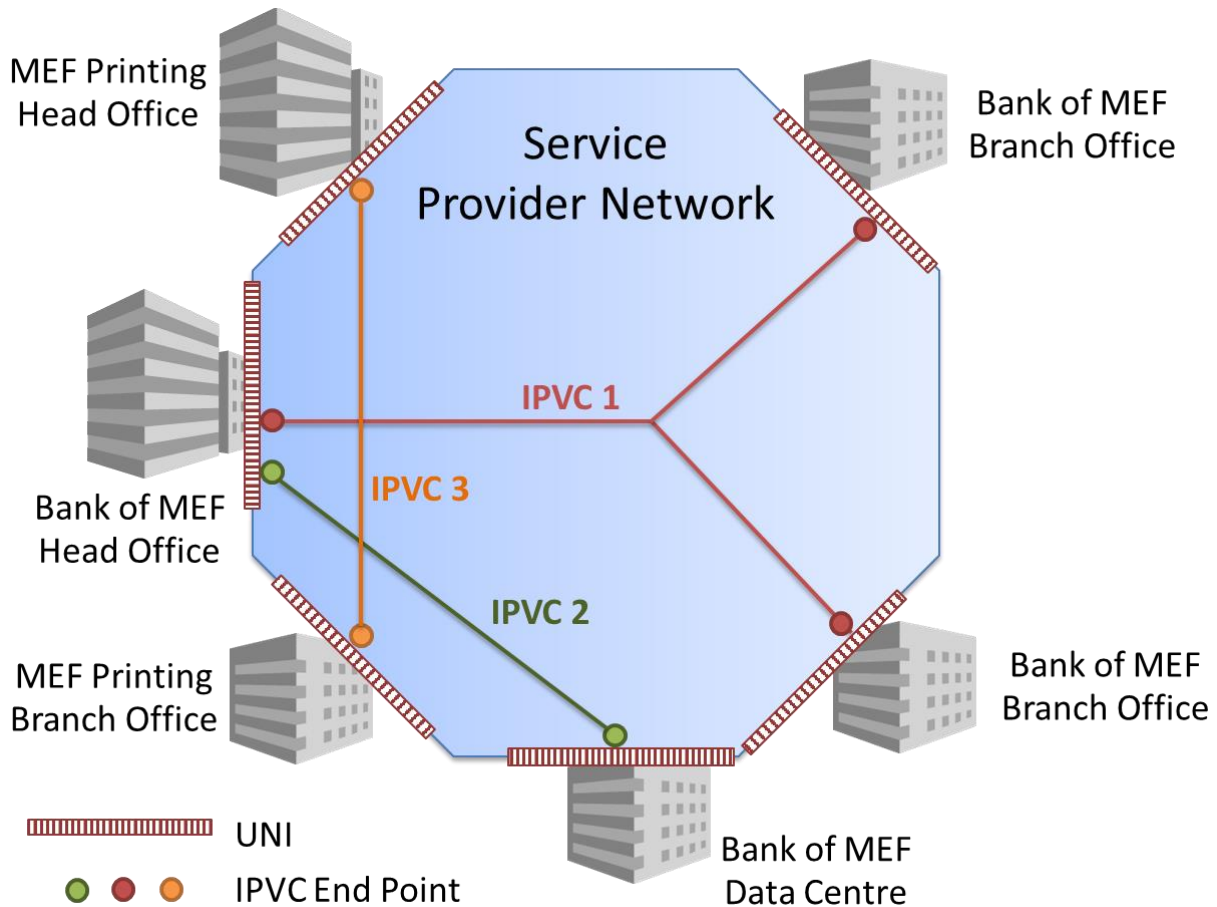
The SLS is generally specified as part of a wider Service Level Agreement (SLA), which might specify financial penalties for the SP if the SLS performance objectives are not met, and can also specify other aspects of the service level experienced by the Subscriber such as the lead time for service modifications or the response time for trouble tickets. Such details are outside the scope of this document.

## 7.7 Virtual Private Network (VPN) Services

A Virtual Private Network service is obtained by a Subscriber to connect together several parts of a Subscriber Network, typically in different physical locations, to create a single “virtual” network. This virtual network is also “private”, in that although the traffic crosses the SP Network, it is segregated from other traffic, such as traffic for other Subscribers and from traffic on the public Internet. This segregation extends to the addressing: the Subscriber need only ensure that IP addresses are unique within their own VPN, and the segregation within the SP Network ensures there is no conflict with other Subscribers, even if they use the same addresses. A Subscriber can obtain several VPN services to connect different parts of the Subscriber Network together in different ways (e.g. creating different topologies or with different bandwidth constraints and performance objectives). This includes accessing multiple VPNs over the same UNI, although in this case it's the Subscriber's responsibility to ensure there is no conflict between the IP Addresses used in the different VPNs.

*VPNs are typically implemented by the SP using BGP/MPLS as described in IETF RFC 4364 [31]. However, this document does not require that BGP/MPLS is used; any implementation that exhibits the same external behavior to the Subscriber is acceptable.*

Figure 8 shows an example of VPN services for two Subscribers using separate Subscriber IPVCs across the SP Network. “Bank of MEF” has two Subscriber IPVCs, one connecting their head office to two branch offices and another connecting their head office to a data center. “MEF Printing” has one Subscriber IPVC connecting their head office to a branch office.



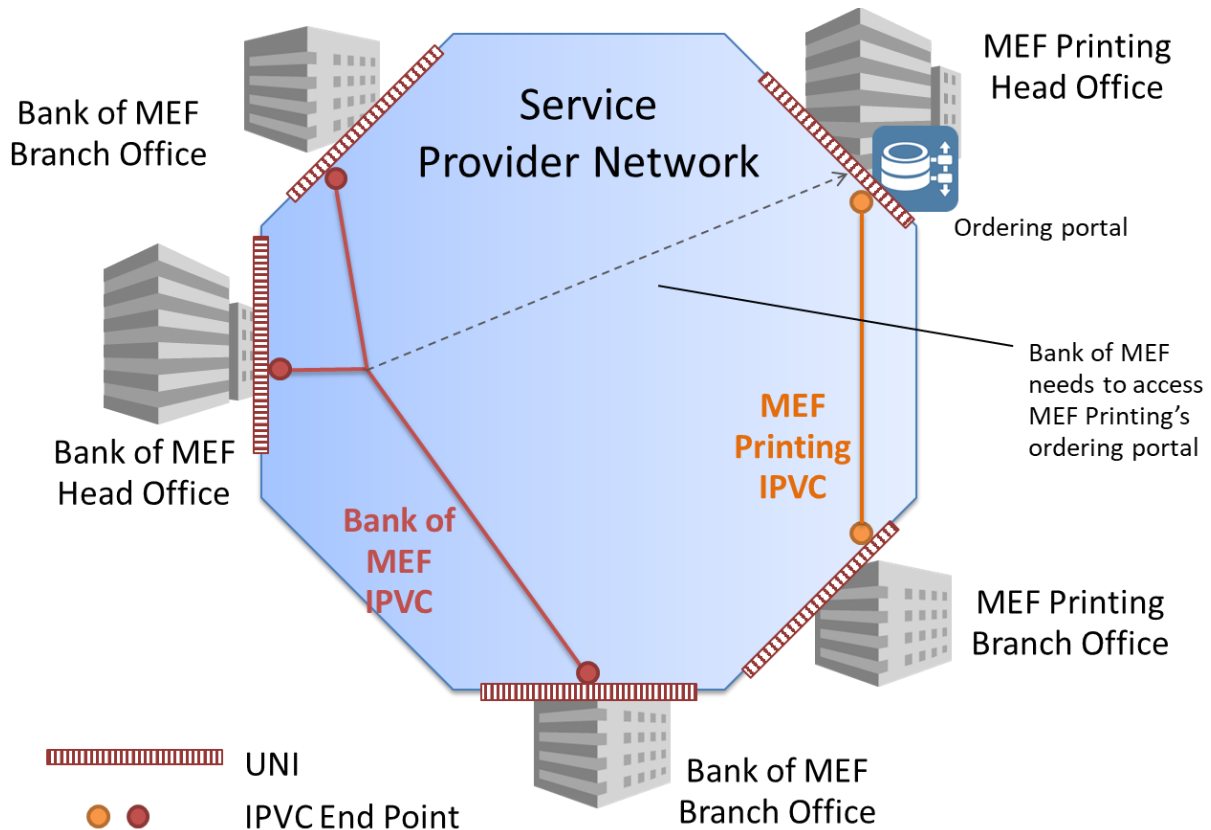
**Figure 8 – Example of Subscriber VPN services**

Note that in this document, a VPN is the same as a Subscriber IPVC, insofar as traffic separation between different VPNs is required. However, in some cases the IP addresses used in different IPVCs are not independent – for example IPVC 1 and IPVC 2 in Figure 8 each have an IPVC EP at the same UNI and therefore the IP addresses used in these IPVCs have to be coordinated.

## 7.8 Extranet Services

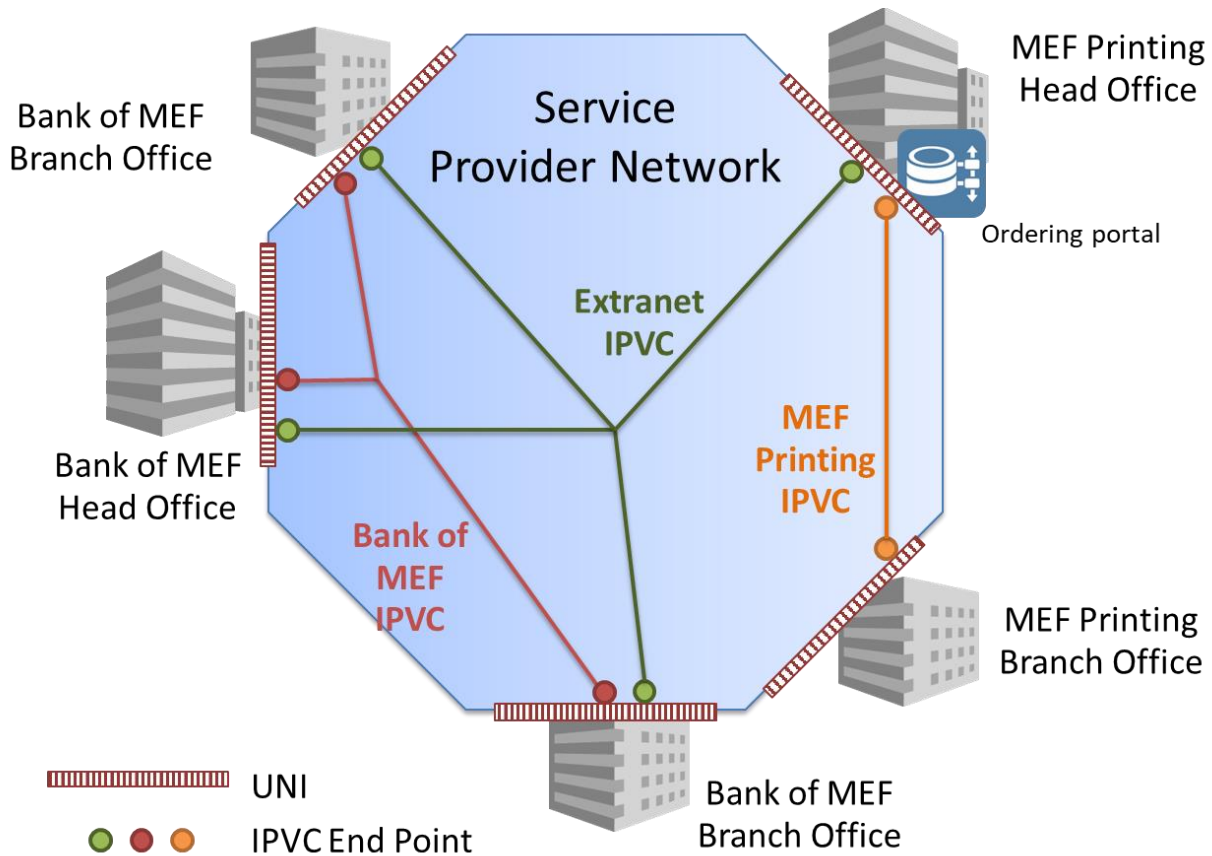
A common enhancement to VPN Services is to add additional connectivity between a Subscriber’s VPN and some external network or host, for example in another Subscriber’s VPN. This is commonly known as an “extranet”. An example of this is to enable an enterprise to access a supplier’s ordering portal through their own VPN, as shown in Figure 9 below, where an enterprise “Bank of MEF” needs to access an ordering portal in one of their suppliers, “MEF Printing”.





**Figure 9 – Extranet example**

An extranet is created by instantiating an additional Subscriber IPVC that links the Bank of MEF Subscriber Network to the MEF Printing Subscriber Network at the UNI where the ordering portal is located. This is shown in Figure 10. Note that as described in this document, this is only possible when Bank of MEF and MEF Printing obtain services from the same Service Provider. Extranets between Subscribers that have different Service Providers are out of scope for this revision of the document and could be addressed in a future revision.



**Figure 10 – Extranet Example showing IPVCs**

In this example, the green extranet IPVC could be a rooted multipoint IPVC (see section 10.2), with the root at the MEF Printing UNI and leaves at the Bank of MEF UNIs; this would prevent it being used for traffic flowing between the Bank of MEF UNIs, which is supposed to use the red Bank of MEF IPVC. At each Bank of MEF UNI, there are two IPVC EPs, and each ingress packet is mapped to one or other of the IPVCs according to the packet’s destination address or other fields. At the MEF Printing UNI where the ordering portal is located, there are again two IPVC EPs and ingress packets can be mapped to the correct one based on the destination address. However, in this case, it is desirable to restrict traffic to and from the IPVC EP for the Extranet IPVC so that it can only be used to access the ordering portal, but not any other devices within MEF Printing’s network. This can be achieved by applying a filter to the IPVC EP based on one or more IP Prefixes, such that only ingress traffic from this IP Prefix or egress traffic destined to it is mapped to the IPVC EP. Further details on packet delivery can be found in section 9, and their application to this example is shown in Appendix B.3.

Note that as the extranet is a separate IPVC, it has its own set of Service Attributes, including the SLS and performance objectives. Note also that when an extranet is used, the IP addresses exposed by the different Subscribers involved in the extranet need to be distinct.

*When BGP/MPLS VPNs are used, extranets are typically implemented (from a routing perspective) by leaking routes from one VPN to another, by judicious use of Route Targets by the SP<sup>3</sup>. This avoids the need for multiple routing lookups, one for each IPVC EP, which would be needed in a simplistic implementation. However, the implementation is not constrained by this specification and any implementation exhibiting the correct externally-visible behavior is acceptable.*

In the example above, each Bank of MEF office uses a single UNI to attach to both the enterprise IPVC and the extranet IPVC. An alternative approach is to use a separate UNI to attach to each IPVC. The choice of approach might have an impact on the service that is agreed, for example on the types of Bandwidth Profile (see section 17) that the SP is able to support.

## 7.9 Internet and Cloud Access Services

An Internet access service or cloud access service differs from a normal VPN service in that rather than connecting multiple parts of a Subscriber Network to each other, the service connects a Subscriber Network to an external network. Note that such a service might only have a single UNI.

Internet access services and private cloud access services are described further in the subsections below.

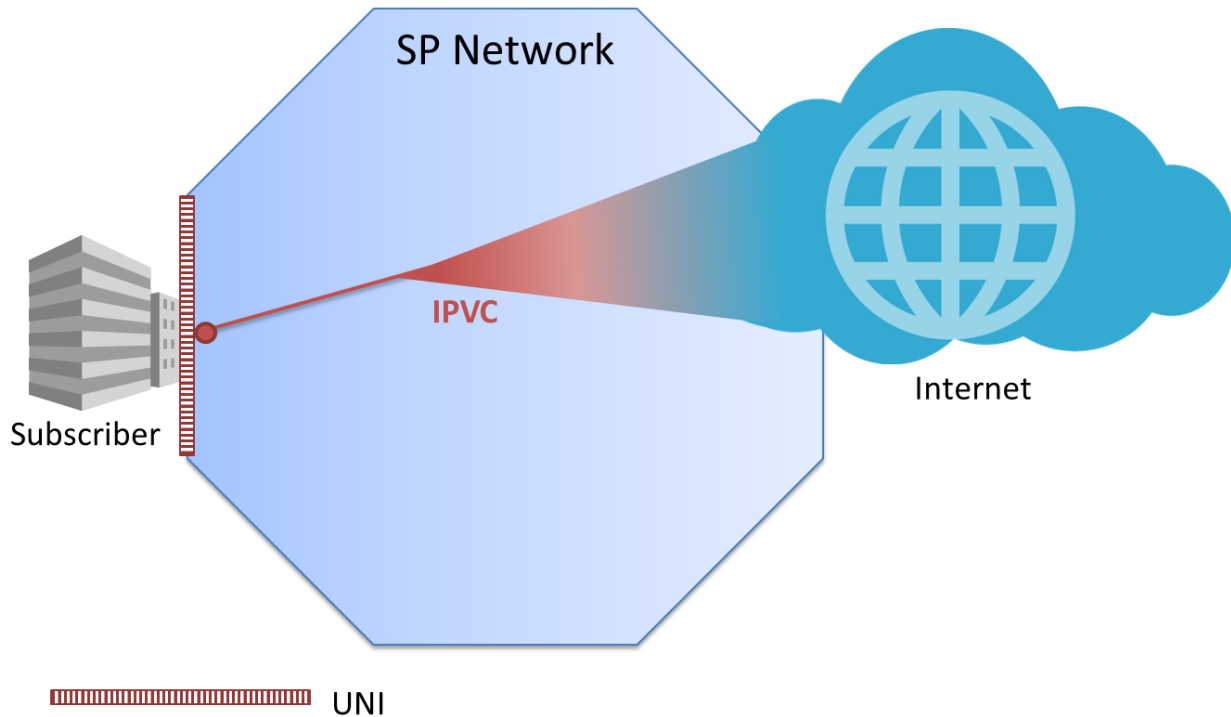
### 7.9.1 Internet Access

An IPVC used for an Internet access service provides the Subscriber with connectivity to the global Internet<sup>4</sup>. If there is a single UNI attached to the IPVC, then it provides Internet access for the Subscriber Network connected at that UNI. If there are multiple UNIs attached to the IPVC, it provides Internet access for the part of the Subscriber Network connected at each UNI, as well as also potentially connecting them to each other. The case of a single UNI is illustrated in Figure 11.

---

<sup>3</sup> See RFC 4364 [31] for an explanation of the use of Route Targets.

<sup>4</sup> In this case the Service Provider is acting as an Internet Service Provider.



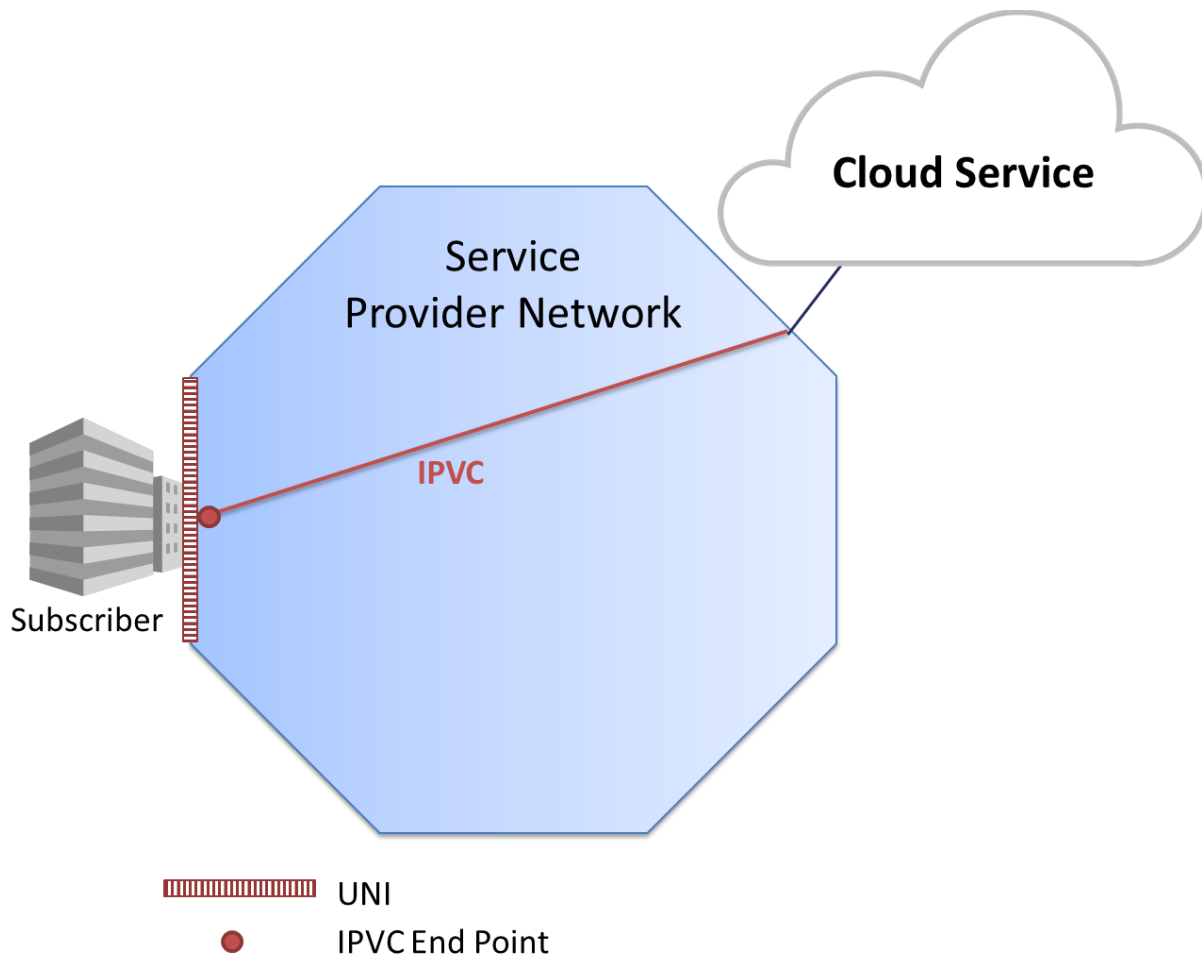
**Figure 11 – Internet Access Service**

From the Subscriber’s perspective, an Internet access service provides general access to a range of content on “the Internet”. The location of the content is typically unknown to the Subscriber, and in particular could be served from within the SP Network or from outside it. This means that, as shown in the figure, there is no clear boundary between the IPVC that provides Internet access and the Internet itself. While there is an IPVC EP at the UNI connecting to the Subscriber, there is no IPVC EP connecting the IPVC to the Internet. A key characteristic of an Internet access service is that from the Subscriber’s perspective, it does not provide any special treatment for traffic to or from a particular location or resource.

An Internet access service can include Network Address Translation (NAT) to enable the Subscriber to use private IP addresses within their network.

### 7.9.2 Private Cloud Access

A private cloud access service connects the Subscriber to a cloud service such as Amazon Web Services, Google Cloud Platform or Microsoft Azure, directly over the SP’s network. While these cloud services can generally be accessed over the public Internet, a private cloud access service can provide better performance, security and assurance for the Subscriber. Typically a Service Provider only offers such a service if they have a direct connection to the Cloud Provider’s network, as illustrated in Figure 12.



**Figure 12 – Cloud Access Service**

The mechanism by which the SP connects to the cloud service is opaque to the Subscriber and hence is outside the scope of this document. In particular, this means there is no Subscriber IPVC EP at the connection between the SP and the cloud service, as there is no need for the Subscriber and the SP to agree on any Service Attribute values that would apply at that point.

Note: the behavior, Service Attributes and requirements for private cloud access services are deferred to a future revision of this specification.

### 7.10 IPVC Topology

The topology of an IPVC is agreed using the IPVC Topology Service Attribute (section 10.2). The possible values are as follows:

- Multipoint – the IPVC connects multiple UNIs with any-to-any connectivity. This might be suitable for a VPN Service as described in section 7.7. Note that a multipoint IPVC that connects exactly two UNIs could be considered a point-to-point service, but this case is not treated specially.

- Rooted Multipoint – the IPVC connects multiple UNIs with restricted connectivity. This can be used to implement a “hub and spoke” network, with one or more hubs. The connectivity is limited by the IPVC EP Role Service Attribute (see section 11.4) for the IPVC EPs for the IPVC. An IPVC EP with a role of *Root* can send and receive traffic from any other IPVC EP, but an IPVC EP with a role of *Leaf* can only send and receive traffic from IPVC EPs with a role of *Root*.
- Cloud Access – the IPVC connects one or more UNIs to a cloud service, i.e. to the Internet or a Private Cloud as described in section 7.9.

Note: a “disjoint hub and spoke” topology, whereby hubs are connected to spokes, but not to each other, can be achieved by using multiple Rooted Multipoint IPVCs, each containing one hub and all of the spokes.

## 7.11 IP Subscriber Services Framework

A complete IP Subscriber Service consists of:

- Exactly one IPVC, with a corresponding set of IPVC Service Attributes (see section 10).
- One or more UNIs where the Subscriber accesses the service, each with a corresponding set of UNI Service Attributes (see section 12).
- Exactly one IPVC EP for the IPVC at each of those UNIs, where each IPVC EP has a corresponding set of IPVC EP Service Attributes (see section 11).
- One or more UNI Access Links in each UNI, each with a corresponding set of UNI Access Link Service Attributes (see section 13).

There is a one-to-one relationship between an IP Service and an IPVC. Note that the IPVC and IPVC EPs (and their Service Attributes) are specific to a given IP Service, whereas the UNIs and UNI Access Links (and their Service Attributes) may be common between multiple IP Services (i.e. if there is more than one IPVC EP at a UNI). Other types of connectivity service – for example, Ethernet Services – could also be offered at the same physical interface as an IP UNI.

Some examples showing all of the Service Attributes for a service can be found in Appendix C.

## 7.12 IP Packets

An IP Packet is either an IPv4 packet as defined in RFC 791 [1], or an IPv6 packet as defined in RFC 8200 [57], from the start of the IP Version field to the end of the IP data field, inclusive.

An IP Packet received from a Subscriber at a UNI (or from another Operator at an ENNI) is called an Ingress IP Packet. An IP Packet transmitted towards a Subscriber at a UNI (or towards another Operator at an ENNI) is called an Egress IP Packet.

IP Packets at an EI can be classified as follows:

- IP Control Protocol Packets. These are packets identified as belonging to a particular control protocol, such as a routing protocol or OAM protocol – optionally with a specific destination (for Ingress IP Packets) or source (for Egress IP Packets) address within the

SP's network – as specified in the UNI List of Control Protocols Service Attribute (see section 12.6) or the ENNI List of Control Protocols Common Attribute (see section 15.4). Ingress IP Control Protocol Packets meeting these criteria are either peered or discarded, and are not forwarded across the IPVC. Egress IP Control Protocol Packets meeting these criteria are generated within the SP's network.

- IP Data Packets. All other packets are considered to be data packets, which are intended to be forwarded across the IPVC from the ingress EI to the egress EI, and are subject to the SLS and other requirements. This includes IP Packets for control protocols not identified in the UNI List of Control Protocols Service Attribute or the ENNI List of Control Protocols Common Attribute (see section 15.4).

Note that although the delivery of multicast IP packets is deferred to a future version of this specification, multicast IP Packets at an EI are still categorized as IP Control Protocol Packets or as IP Data Packets per the definitions above.

## 8 Key Concepts for Operator IP Services

The concepts used to describe Operator IP Services include those used for Subscriber IP Services, as described in section 7. This section explains some additional concepts necessary for understanding Operator IP Services.

### 8.1 Operator IP Services

When a Service Provider provides an end-to-end Subscriber IP Service to a Subscriber, they might not be able to implement the entire service using their own network – for instance, one of the Subscriber’s UNIs might be located in a geographic region where the Service Provider does not operate. In this case, the Service Provider must partner with another Operator who can reach that UNI. The Operator provides an IP connectivity service between the UNI and a point where they can interconnect with the SP’s network.

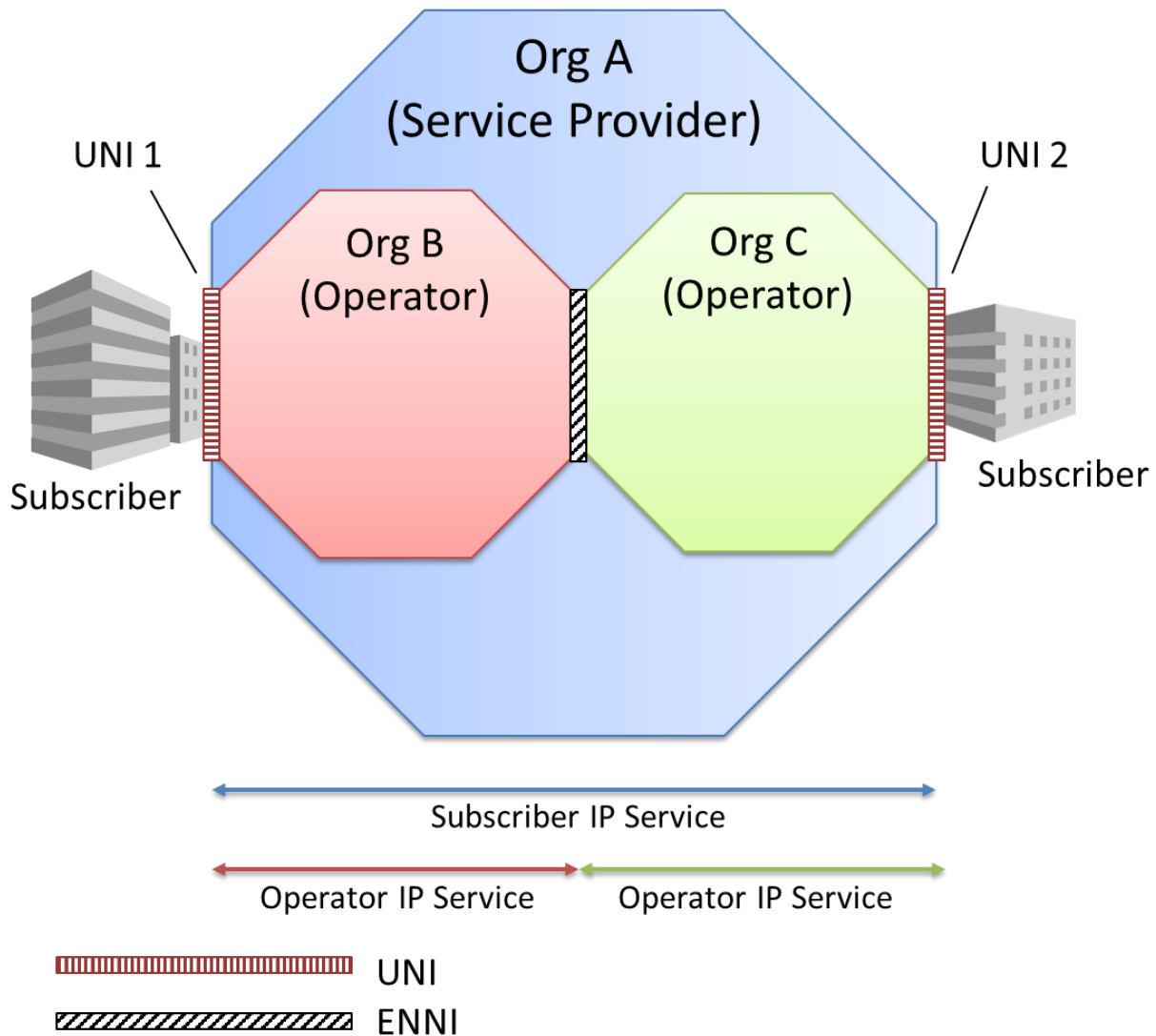
Such IP Services – provided by one Operator to another Operator or a Service Provider, in order to implement part of an end-to-end Subscriber IP Service – are known as Operator IP Services.

It is possible that a Service Provider does not operate their own network at all, and instead implements end-to-end Subscriber IP Services by stitching together multiple Operator IP Services from two or more Operators.

Note that an IP Subscriber Service is always agreed between a Subscriber and the Service Provider – the Subscriber is not aware of the Operators that may be used to implement the service, and does not have any business relationship with them.

An example of a Subscriber IP Service connecting different parts of a Subscriber’s network at two different locations is shown in Figure 13. In this case, the Subscriber IP Service is provided by Organization A acting as the Service Provider, and implemented using two Operator IP Services, provided by Organization B and Organization C.

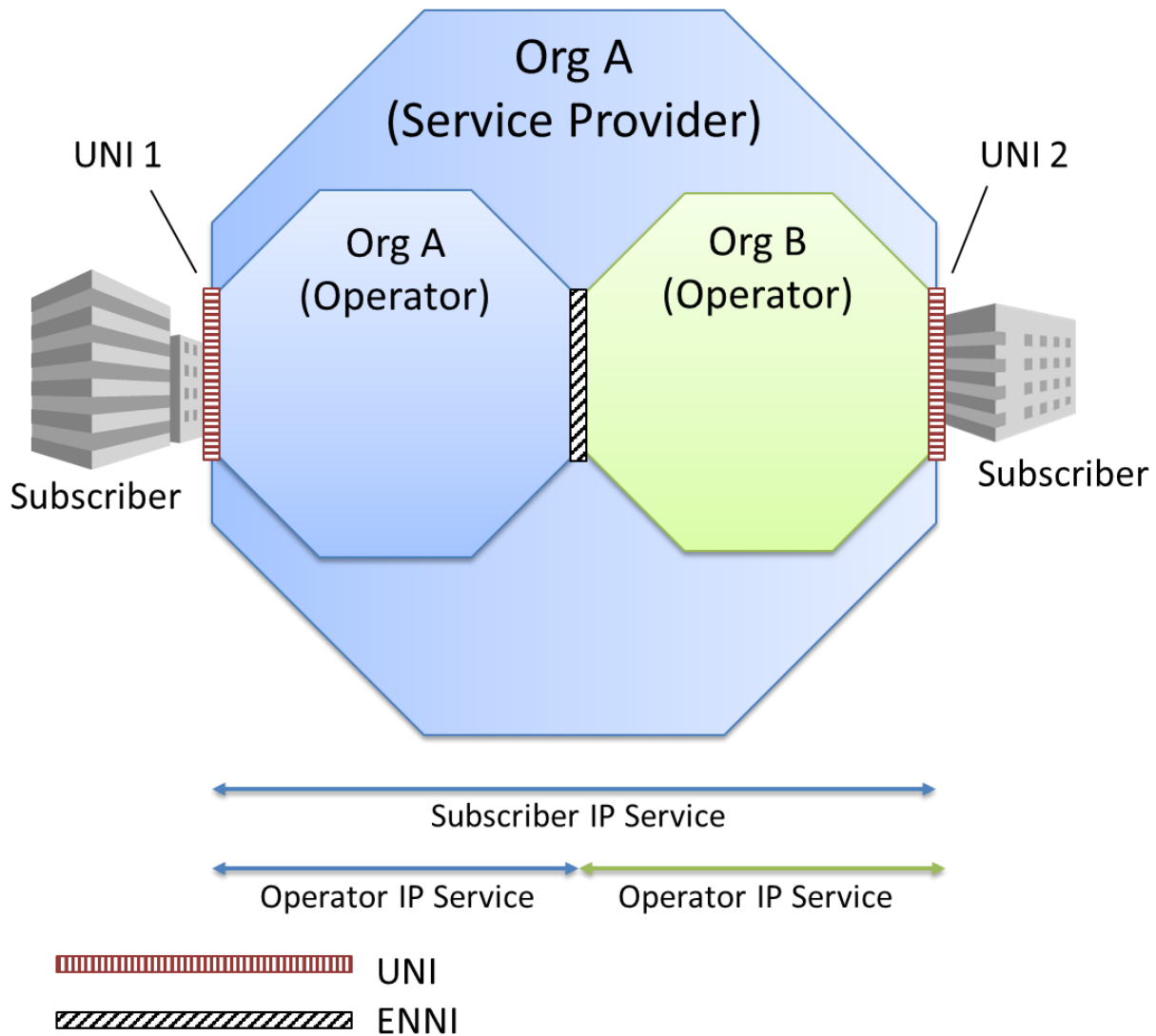




**Figure 13 – Operator IP Services**

In this example, the Service Provider (A) has implemented the Subscriber IP Service by agreeing on Operator IP Services with two Operators (B and C). These are linked together to form the Subscriber IP Service.

A common scenario is that the Service Provider who is responsible for the end-to-end Subscriber IP Service also acts as the Operator for one (or more) of the Operator IP Services used to implement it, as shown in Figure 14. In other words, the terms Service Provider and Operator indicate roles with respect to a given service; they are not necessarily separate organizations.



**Figure 14 – Operator IP Services with the SP acting as an Operator**

In the example shown in Figure 14, the Service Provider (A) connects to the Subscriber directly at UNI 1, but uses an Operator IP Service to connect to the Subscriber at UNI 2 – perhaps because they do not operate a network in that location. At UNI 1, the same organization (A) acts both as the Service Provider, and as an Operator. As the Service Provider, they are responsible to the Subscriber for providing the end-to-end service between UNI 1 and UNI 2, i.e. a Subscriber IP Service. As an Operator, they are responsible for the connectivity between UNI 1 and the ENNI, i.e. an Operator IP Service. Logically, the organization (in its role as an Operator) provides the Operator IP Service to itself (in its role as the Service Provider). In practice, whether such a formal agreement is used within the organization is a matter of internal policy.

Note that in all these cases, the service being provided by the Operator is an IP Service. An alternative is possible whereby an Operator provides an L2 service between the SP and a remote UNI – for example, an E-Access Service. In this case, there is a single IP hop between the SP and the

Subscriber – in other words, the entire L2 service is a single UNI Access Link for the IP Subscriber Service. Such a scenario is outside the scope of this document, but is illustrated in Appendix E.

## 8.2 ENNIs and ENNI Links

An External Network Network Interface (ENNI) is the demarcation point between the responsibility of one Operator and another – in other words, it is the interface where two Operators interconnect.

Like a UNI, an ENNI can comprise one or more distinct IP Links, each of which is a single IP hop. These links are known as ENNI Links, and typically each corresponds to a distinct IP subnet (which can have both IPv4 and IPv6 addressing). ENNI Links are assumed to be point-to-point. Some examples of ENNI Links are as follows (this is not an exhaustive list):

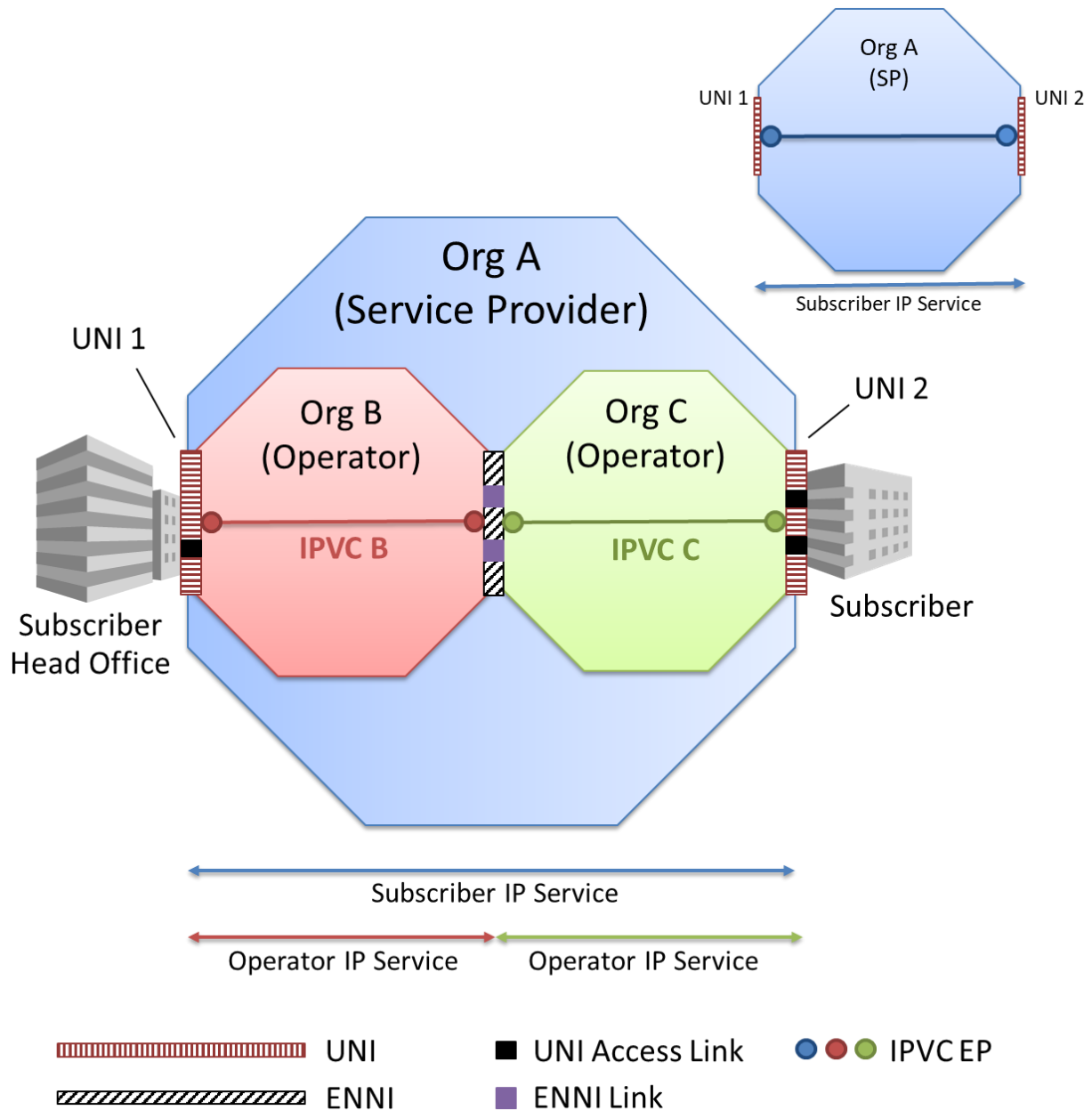
- a distinct physical connection.
- a logical Layer 2 connection (for example, an Ethernet VLAN with a given VLAN ID). Such a Layer 2 connection might be over a single physical link, an aggregation of physical links (e.g. an Ethernet Link Aggregation Group) or an entire Layer 2 network (e.g. an Ethernet Switch or an Ethernet E-Transit service).
- An IP tunnel (e.g. using GRE) over another IP network (e.g. over the Internet). In this case the ENNI Link is the tunnel (which is a single IP hop), not the underlying IP network.

When two Operators are connected by a number of ENNI Links, they need to agree how these links are grouped together to form ENNIs (via the ENNI List of ENNI Links Common Attribute, section 15.3). Each ENNI Link belongs to exactly one ENNI. This document does not constrain how ENNI Links are grouped to form ENNIs.

## 8.3 Service Attributes for Operator IP Services

Operator IP Services are described in a similar way to Subscriber IP Services, i.e. using the concepts of UNIs, UNI Access Links, IPVCs and IPVC End Points, as well as ENNIs and ENNI Links. An IPVC used for an Operator IP Service is known as an Operator IPVC.

Figure 15 shows the Service Provider's view of a Subscriber IP Service implemented using two Operator IP Services. The IPVC and IPVC EPs for the Subscriber IP Service (between the two UNIs) is shown in the top right of the figure.



**Figure 15 – Example showing Operator IPVCs**

There are four distinct business relationships involved in this example:

- The Subscriber agrees on the details of the Subscriber IP Service with the Service Provider (A).
- The two Operators (B and C) agree with each other to implement an ENNI between them.
- The Service Provider (A) agrees on the details of an Operator IP Service with Operator B.
- The Service Provider (A) agrees on the details of an Operator IP Service with Operator C.

As shown in the figure, there are three distinct IPVCs in this example, each with two IPVCEPs: one Subscriber IPVC provided as part of the Subscriber IP Service by the SP to the Subscriber,

and two Operator IPVCs provided as part of the Operator IP Services by each Operator to the SP. The Operator IP Services (and their corresponding IPVCs and IPVC EPs) are used by the SP to implement the Subscriber IP Service (and its corresponding IPVC and IPVC EPs) that they have agreed on with the Subscriber.

A different set of Service Attributes applies in each of the different business relationships. The Service Attributes for a Subscriber IP Service are categorized as follows (as described in section 7.11):

- IPVC Service Attributes (see section 10).
- IPVC End Point Service Attributes (section 11).
- UNI Service Attributes (section 12).
- UNI Access Link Service Attributes (section 13).

For the two Operators to create an ENNI, a number of Service Attributes must be agreed. These are categorized as follows:

- ENNI Common Attributes (section 15).
- ENNI Link Attributes (section 16).

Service Attributes for the Operator IP Service that the SP agrees with each Operator are categorized as follows:

- IPVC Service Attributes (section 10).
- IPVC End Point Service Attributes (section 11).
- UNI Service Attributes (section 12).
- UNI Access Link Service Attributes (section 13).
- ENNI Service Attributes (section 14).

Note that at a given UNI, there is a set of UNI Service Attributes and UNI Access Link Service Attributes agreed between the Subscriber and the Service Provider in the context of the Subscriber IP Service, and also a separate set of UNI Service Attributes and UNI Access Link Service Attributes agreed between the Service Provider and the Operator in the context of the Operator IP Service. A given attribute might or might not have the same value in these two sets.

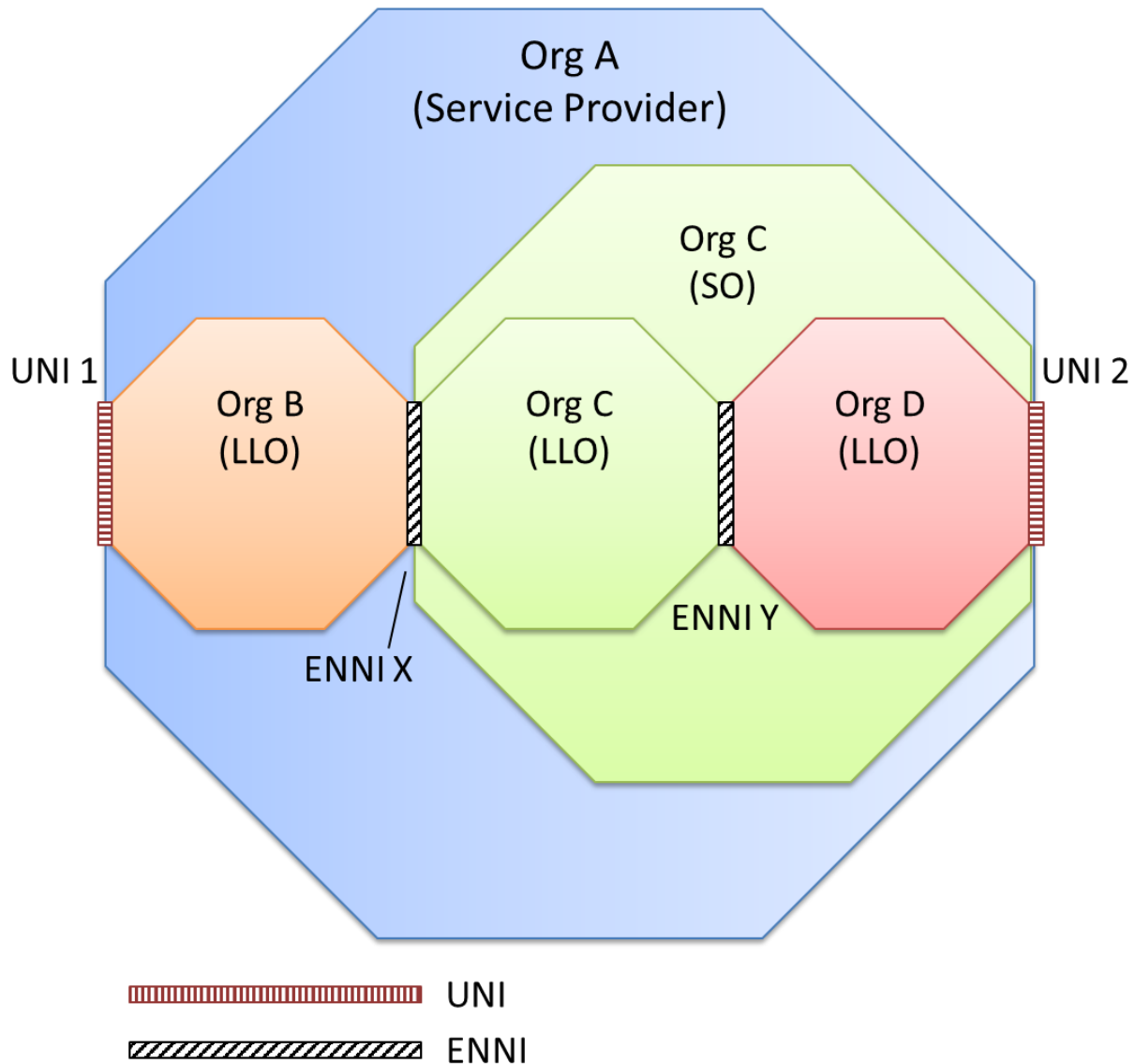
Similarly, the value of the IPVC and IPVC EP Service Attributes for the Subscriber IP Service might or might not be the same as the value of the IPVC and IPVC EP Service Attributes for either of the Operator IP Services. For example, the value of an IPVC EP Service Attribute for the Subscriber IPVC EP at UNI 1 might be different to the value of that Service Attribute for the Operator IPVC EP at UNI 1.

Note also that there are two types of attributes that apply to an ENNI: ENNI Common Attributes are agreed between the two Operators on either side of the ENNI, whereas ENNI Service Attributes are agreed between each Operator and the Service Provider. For a given Service Provider using an ENNI, there are two sets of ENNI Service Attributes (one for each Operator), but there is a single set of ENNI Common Attributes.

An ENNI between two given Operators can be used by multiple Service Providers, to provide Subscriber IP Services to different Subscribers. Each Service Provider might agree on one or more Operator IP Services that terminate at the ENNI.

### 8.4 IP Operator Service Hierarchy

Just as a Subscriber IP Service can be implemented using two or more Operator IP Services, an Operator IP Service itself can be implemented using two or more other Operator IP Services. This is illustrated in Figure 16.



**Figure 16 – Example of Hierarchical Operator IP Services**

In this example, the SP (A) has agreed on Operator IP Services with two Operators (B and C) in order to implement an end-to-end Subscriber IP Service between the UNI 1 and UNI 2. However, Operator C has implemented the Operator IP Service agreed with the SP by agreeing on a further

Operator IP Service with Operator D to connect to UNI 2, and implementing their own Operator IP Service between the two ENNIs. Note that the Service Provider (A) has no business relationship with Operator D and may not even be aware of them. Note also that there are three sets of Service Attributes that apply at UNI 2: those agreed between the Subscriber and the SP (A) as part of the end-to-end Subscriber IP Service; those agreed between the SP (A) and Organization C, as part of the Operator IP Service between ENNI X and UNI 2; and those agreed between Organization C and Organization D as part of the Operator IP Service between ENNI Y and UNI 2.

If an Operator IP Service is implemented by decomposing it into further Operator IP Services, the Operator is referred to as a Super Operator (SO) for that service. If an Operator IP Service is not further decomposed, the Operator is referred to as a Lowest Level Operator (LLO) for that service. It should be stressed that these terms only apply in the context of a given service – an organization that is a Super Operator for one service might be a Service Provider for another service, and a Lowest Level Operator for a third service.

At an ENNI, the requirements of this document mandate that an SO for a service that terminates at an ENNI must be the LLO at the ENNI for any constituent services (as illustrated in Figure 16). This simplifies the Service Attributes considerably, as it means there are always exactly two organizations involved in agreeing on an ENNI, one on each side of it. Scenarios where this is not the case are outside the scope of this document.

An Operator IP Service can be used by an SP or by an SO. For ease of exposition, in the remainder of this document, the user of an Operator IP Service is referred to as an SP/SO.

## 8.5 Operator IP Service Framework

To establish an ENNI, two Operators must agree on:

- Exactly one set of ENNI Common Attributes (see section 15).
- One or more ENNI Links for the ENNI, each with a corresponding set of ENNI Link Attributes (see section 16).

A complete Operator IP Service consists of:

- Exactly one Operator IPVC, with a corresponding set of IPVC Service Attributes (see section 10).
- Zero or more UNIs, each with a corresponding set of UNI Service Attributes (see section 12).
- One or more ENNIs, each with a corresponding set of ENNI Service Attributes (see section 14).
- Exactly one IPVC EP for the IPVC at each of the UNIs and each of the ENNIs, where each IPVC EP has a corresponding set of IPVC EP Service Attributes (see section 11).
- One or more UNI Access Links in each UNI, each with a corresponding set of UNI Access Link Service Attributes (see section 13).

There is a one-to-one relationship between an IP Service and an IPVC. Note that the IPVC and IPVC EPs (and their Service Attributes) are specific to a given IP Service, whereas the UNIs,

ENNI, and UNI Access Links (and their Service Attributes) may be common between multiple IP Services.

An Operator IP Service always has at least one ENNI, and at least two EIs in total. Note that Operator IP Services that connect to a Cloud Service (which might only have one EI) are deferred to a future version of this specification.

## 8.6 Connecting Services across an ENNI

In order for a Service Provider (or Super Operator) to create an end-to-end Subscriber IP Service (or a higher-level Operator IP Service) by stitching together Operator IP Services at an ENNI, a mechanism is needed to relate the Operator IP Service on one side of the ENNI to the corresponding Operator IP Service on the other side of the ENNI, such that Egress IP Packets from one service become Ingress IP Packets for the other service. There are a number of ways this can be done, keeping in mind that there may be a large number of services crossing the ENNI, and they may not have distinct IP addressing. For example:

- Packets can be sent over different ENNI Links depending on which service they should be mapped to by the receiving Operator.
- Packets can be encapsulated, for example using MPLS, where the MPLS labels identify the service that the packet should be mapped to.

A related aspect to the mapping of the Data IP Packets is the mapping of control plane routing information – that is, ensuring that routes towards destinations reachable in the service on one side of an ENNI are made available to the corresponding service (and no others) on the other side of the ENNI. Again, there are many ways this could be done. RFC 4364 [31] identifies in particular three mechanisms, all of which use BGP across the ENNI. They are referred to as Options A, B and C:

- Option A: A separate eBGP session is used across each ENNI Link, and each session carries routes for one service. This results in packets for different services being sent over different ENNI Links. The packets can be plain IP Packets since it is the different links that distinguish them.
- Option B: One or more eBGP sessions are used across the ENNI, each exchanging labelled VPN routes for multiple services. The routes for different services are distinguished by attributes such as Route Distinguishers and Route Targets. This results in IP Packets across the ENNI being encapsulated in MPLS, where IP Packets for different services have different MPLS labels. Typically each packet has a single MPLS label, that identifies both the egress PE and the service.
- Option C: One or more eBGP sessions are used across the ENNI only to distribute labelled unicast routes (and labels) towards each Operator's own routers; furthermore, multipoint eBGP sessions are used between the ingress PE and the egress PE (or equivalent route reflectors) to exchange labelled VPN routes for each service. This results in IP Packets across the ENNI being encapsulated in MPLS, typically with two MPLS labels, one representing the egress PE, and a second that (roughly speaking) identifies the service.



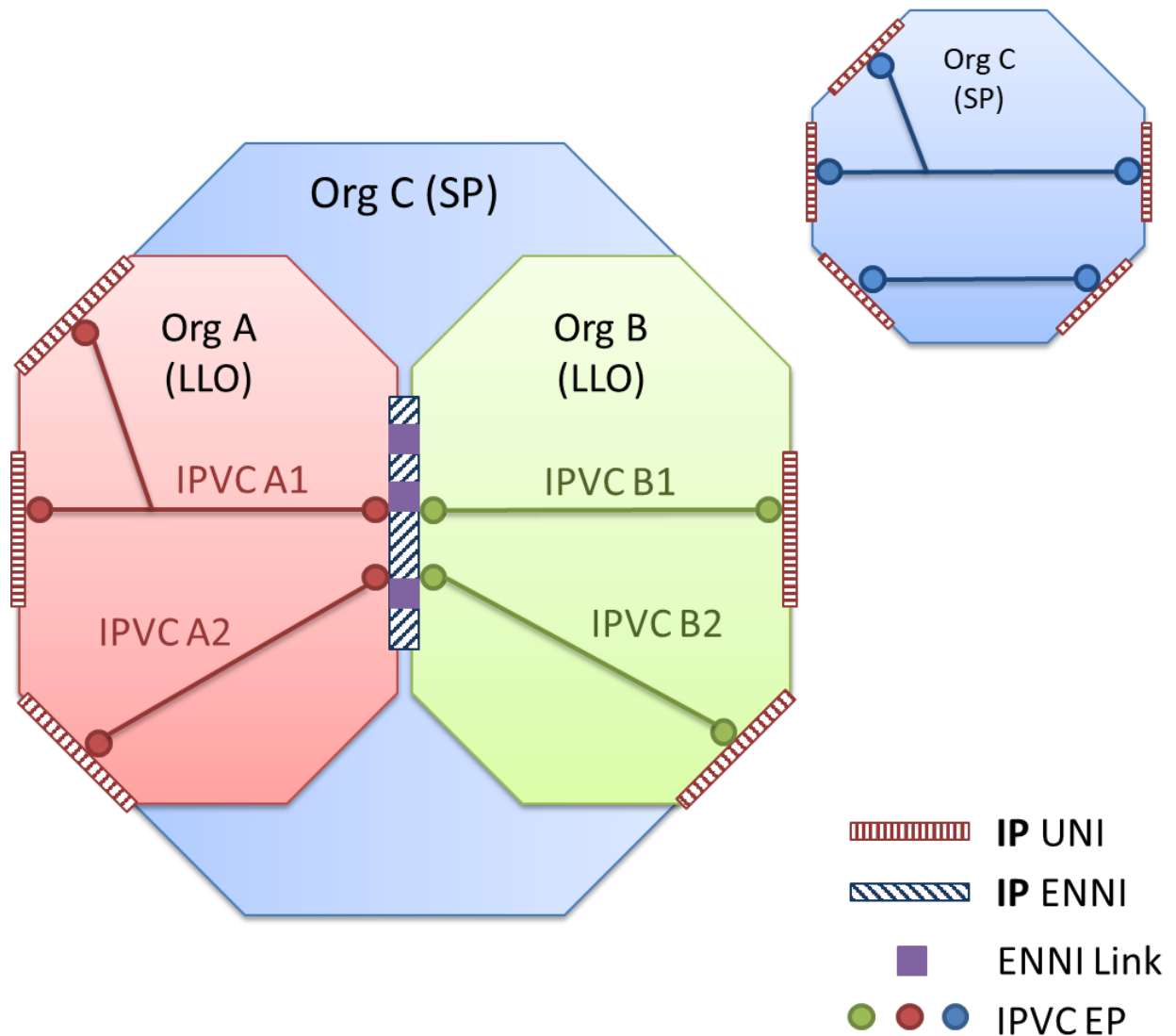
Regardless of which option is used, services provided by the Operator on one side of the ENNI need to be matched with the corresponding services provided by the Operator on the other side of the ENNI, in order to realize the intended end-to-end (UNI to UNI) service for the Subscriber. In other words, IP Packets transmitted over the ENNI from a given egress IPVC EP in one Operator need to be mapped to the correct ingress IPVC EP on reception by the other Operator.

For Option A, this is done in the data plane, by matching up the ENNI Links that each IPVC EP is mapped to, and hence that each end-to-end service is carried on. For Option B and Option C, the matching is done in the control plane, by matching the route targets that are carried in the BGP sessions across the ENNI (for Option B) or in the BGP sessions between the ingress and egress PEs, or equivalent route reflectors (for Option C). In this case, the traffic is separated in the data plane by the use of dynamically allocated MPLS labels.

The option used at an ENNI is set using the ENNI Peering Type Common Attribute (section 15.2) and the ENNI Type Service Attribute (section 14.2). This document covers only Option A; Option B and Option C are deferred to a future revision.

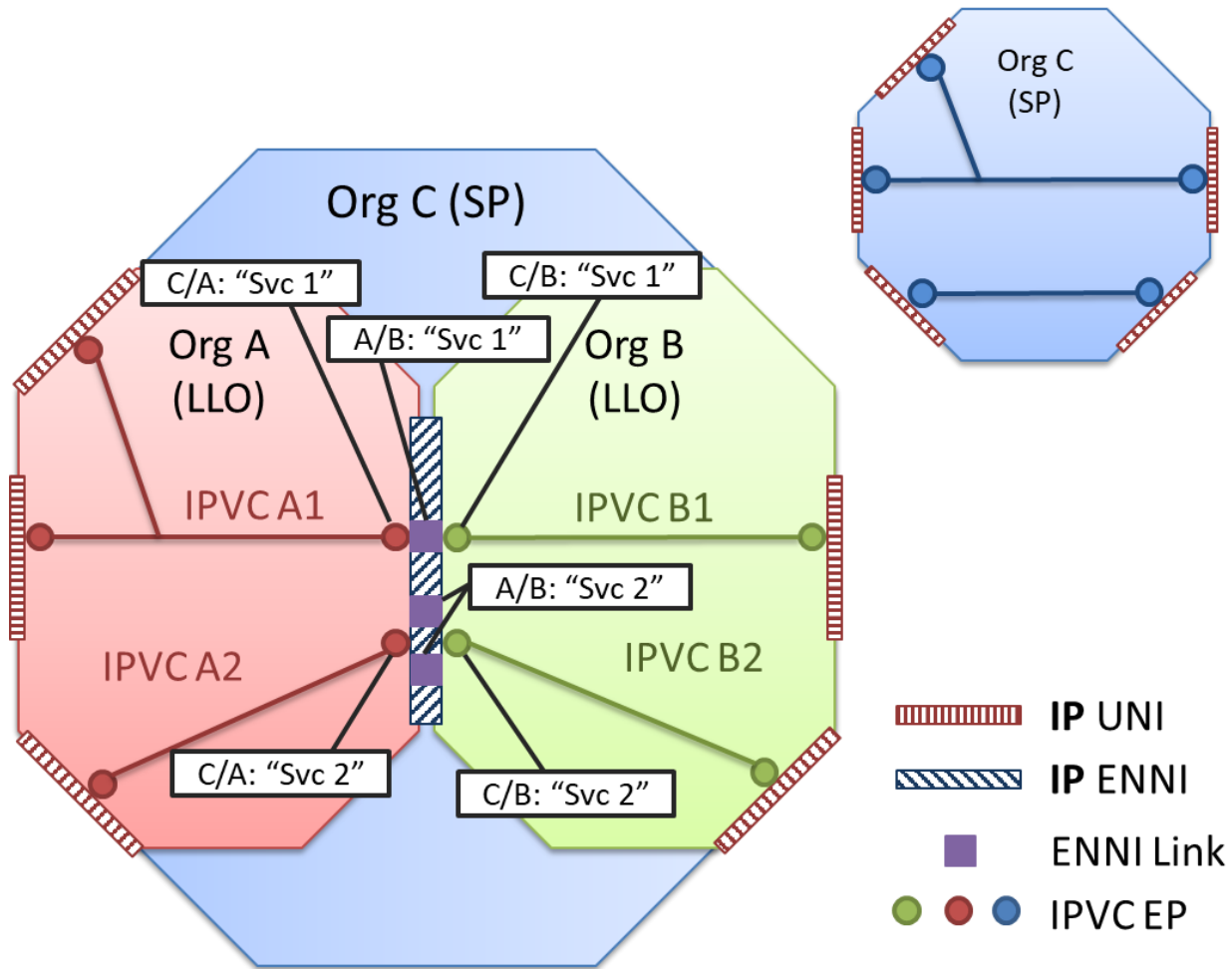
For Option A, the SP/SO that is using the Operator IP Services on either side of the ENNI assigns an ENNI Service Mapping Identifier to each IPVC End Point on either side of the ENNI. The two operators then match up the ENNI Service Mapping Identifiers by agreeing which ENNI Links to use for each of the SP/SO's ENNI Service Mapping Identifiers. The service with a particular ENNI Service Mapping Identifier on one side of the ENNI is matched with the service with the same ENNI Service Mapping Identifier (from the same SP/SO) on the other side of the ENNI.

For example, consider the scenario shown in Figure 17. The SP (C) is providing two Subscriber IPVCs as shown in the top right. To implement these, they use Operator IP Services from Operators A and B. For correct operation across the ENNI, the IPVC EP for IPVC A1 needs to be linked with the IPVC EP for IPVC B1, and likewise the IPVC EP for IPVC A2 needs to be linked with the IPVC EP for B2.



**Figure 17 – Example of two IP Services across and ENNI**

To accomplish this, the SP agrees an ENNI Service Mapping Identifier (e.g. “Svc 1”) with Operator A for the IPVC EP for A1, and the same ENNI Service Mapping Identifier with Operator B for the IPVC EP for B1. The SP agrees a different ENNI Service Mapping Identifier (e.g. “Svc 2”) for the IPVC EPs for A2 and B2 with Operators A and B respectively. Assuming the ENNI uses Option A, Operators A and B then agree with each other which ENNI Links will carry “Svc 1” and which will carry “Svc 2”. The values agreed between the different parties are shown in Figure 18. In this example, the Operators have assigned one ENNI Link to “Svc 1” and two ENNI Links to “Svc 2”.



**Figure 18 – Example of ENNI Service Mapping Identifiers for IP Services across an ENNI**

The Operators ensure that IP Packets for IPVC EPs with a given ENNI Service Mapping Identifier are transmitted over the ENNI Links assigned to that ENNI Service Mapping Identifier, and that IP Packets received on an ENNI Link with a given ENNI Service Mapping Identifier are mapped back to the IPVC EPs with that ENNI Service Mapping Identifier. So, for example, a packet being transmitted from IPVC A1, which has ENNI Service Mapping Identifier “Svc 1”, is sent over the ENNI Link that has been assigned to “Svc 1”. When it is received by B, it is mapped to IPVC EP B1, because that also has ENNI Service Mapping Identifier “Svc 1”. Thus, IPVC A1 is linked to IPVC B1 and the correct end-to-end behavior is realized.

Note that there could be more than one SP/SO using services across the same ENNI (see example in section 15.6.1). ENNI Service Mapping Identifiers are only unique for a given SP/SO; thus it is possible that two SP/SOs use the same ENNI Service Mapping Identifier, for different services. When the two Operators on either side of the ENNI assign ENNI Links to services, they must therefore actually consider the pair of (SP/SO, ENNI Service Mapping Identifier) to ensure uniqueness. This pair is called the ENNI Service Mapping Context. Note that how the Operators identify SP/SOs that use the ENNI is outside the scope of this document, but needs to be agreed between the two Operators.

For ease of exposition in the remainder of the document, we refer to an IPVC EP at an ENNI as having an ENNI Service Mapping Context; this means that the IPVC EP relates to a service for the SP/SO named in the ENNI Service Mapping Context, and has been assigned the value of the ENNI Service Mapping Identifier in the ENNI Service Mapping Context.

The matching of services on either side of an ENNI is controlled by two attributes:

- IPVC EP ENNI Service Mapping Identifier Service Attribute (section 11.6) – this is used by the SP/SO to set the ENNI Service Mapping Identifier for a given IPVC EP.
- ENNI Service Map Common Attribute (section 15.6) – this is used by the Operators on either side of the ENNI to assign an ENNI Service Mapping Context to each ENNI Link.

If a given ENNI Service Mapping Context is assigned to an ENNI Link, then Egress IP Packets from IPVC EPs that have that ENNI Service Mapping Context are transmitted over the ENNI Link, and on ingress to the other Operator's network, they are mapped to an IPVC EP that has the same ENNI Service Mapping Context.

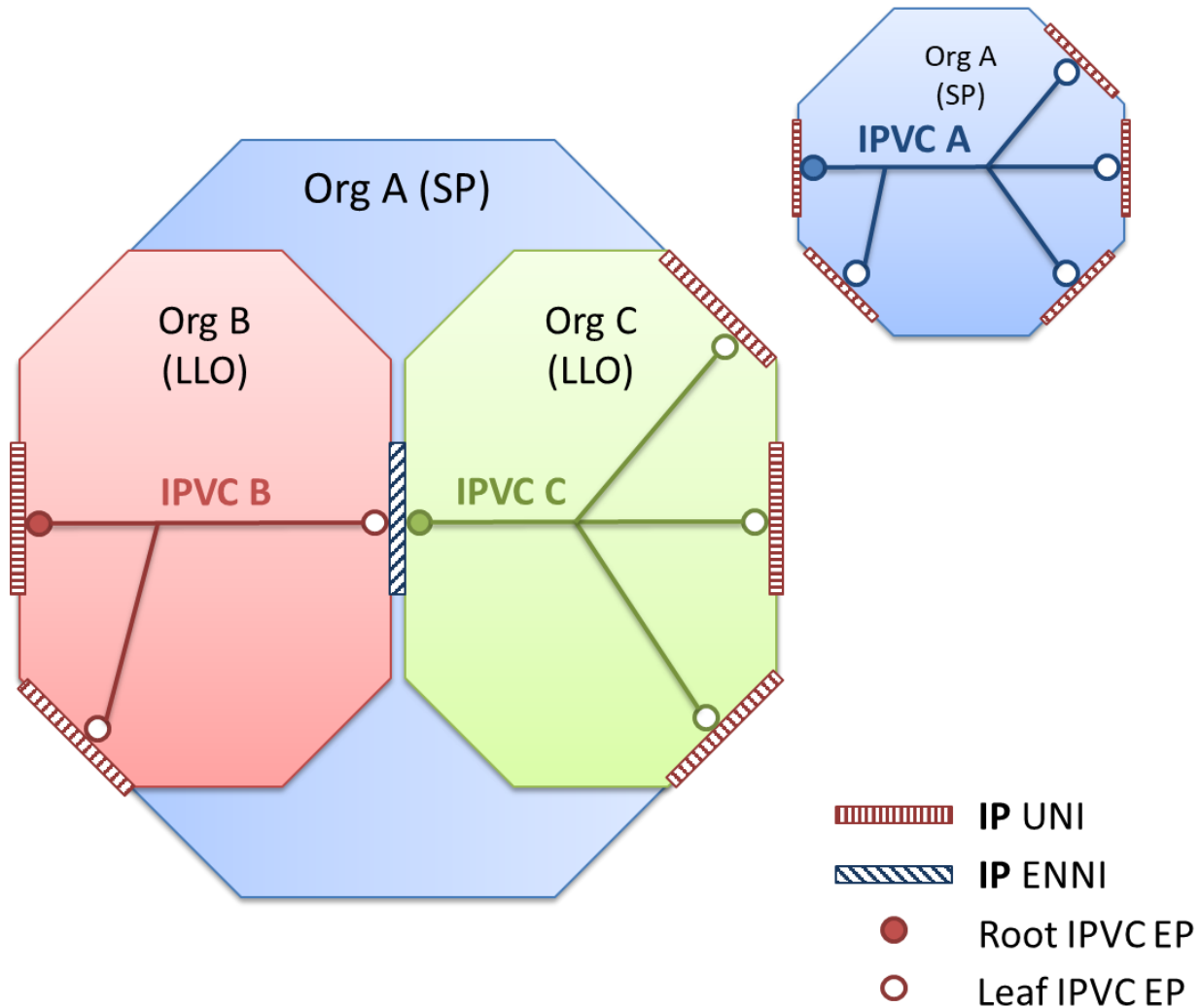
Note that multiple links can be used for a given ENNI Service Mapping Context – this can improve resiliency. It is also possible for the same ENNI Service Mapping Identifier to be used by two or more IPVC EPs for different IPVCs at an ENNI; however, the details of such a configuration are deferred to a future revision of this specification. A given IPVC cannot have more than one IPVC EP at an ENNI.

A further example of ENNI Service Mapping Context Mapping can be found in section 15.6.1.

## 8.7 Rooted Multipoint Services across an ENNI

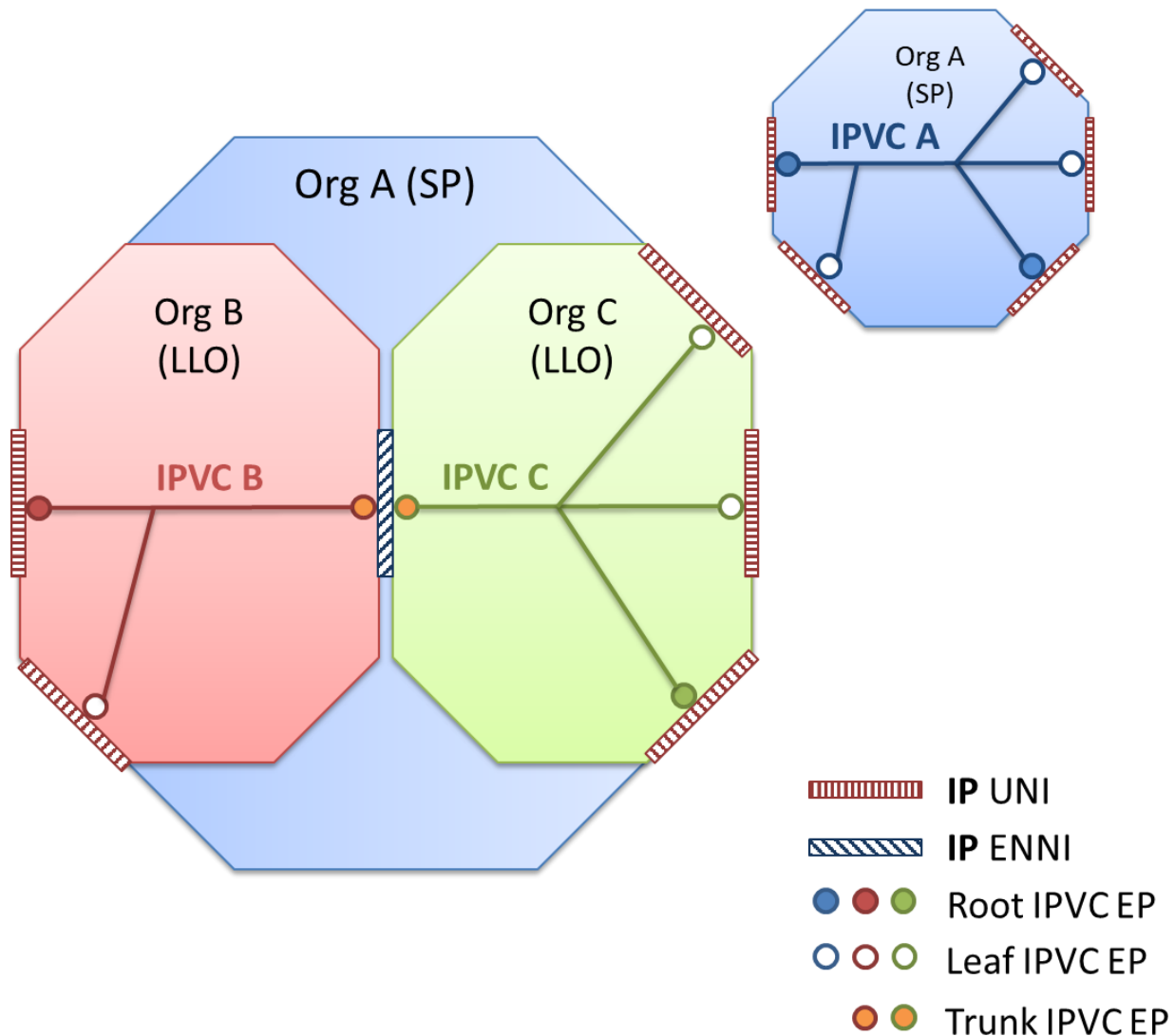
A Service Provider that has agreed on a rooted multipoint Subscriber IPVC (see section 7.10) with a Subscriber might implement this using Operator IPVC Services agreed with two (or more) Operators across an ENNI. In this case, the correct operation of the rooted multipoint Subscriber IPVC can be achieved by selecting the roles of the IPVC EPs (see section 11.4) for the Operator IPVCs appropriately.

Figure 19 shows an example of such a case. The Subscriber IPVC agreed between the SP (A) and the Subscriber is shown in the top right part of the figure. The SP (A) implements the Subscriber IPVC by agreeing on Operator IPVCs with two Operators (B and C), as shown in the main part of the figure.



**Figure 19 – Example of a Rooted Multipoint IPVC across an ENNI**

In this example, one of the Operator IPVCs has the property that all of the IPVC EPs at UNIs have the same role – i.e., in IPVC C, all the IPVC EPs at UNIs have *Leaf* role. In this case, the correct operation of the Subscriber IPVC can be achieved by using *Root* role and *Leaf* role for the IPVC EPs at the ENNI, as shown. In this example, both the Operator IPVCs are also rooted multipoint IPVCs, but in some cases one of them could be a multipoint IPVC. Note that although the Subscriber IPVC can be implemented in this case using only *Leaf* and *Root* Role IPVC EPs at the ENNI, the SP might not choose this option as it would make it harder to later add a *Root* IPVC EP that was reachable via Operator C. Figure 20 shows an example that illustrates this case.



**Figure 20 – Example of a Rooted Multipoint IPVC across an ENNI with Trunk IPVC EPs**

In this case, both of the Operator IPVCs have at least one IPVC EP at a UNI with *Root* role, and at least one with *Leaf* role. It is not possible to obtain the correct operation of the Subscriber IPVC by assigning either *Leaf* role or *Root* role to the IPVC EPs at the ENNI – a new value, called *Trunk* role, must be used. *Trunk* role indicates that the IPVC EPs carry traffic for both roots and leaves.

When *Trunk* role is used, additional information is needed at the ENNI to ensure that traffic originally mapped to an IPVC EP with *Leaf* role in one Operator IPVC is not delivered to an IPVC EP with *Leaf* role in the other Operator IPVC, after having crossed the ENNI. This additional information is used to mark routes advertised across the ENNI as being towards a Leaf (with the default behavior that routes not so marked are towards Roots) – see sections 11.4 and 15.5.

## 9 Routing and Packet Delivery in an IPVC

There are various Service Attributes described in the following sections that affect how Ingress IP Packets are delivered – that is, how an IPVC EP is chosen at the ingress EI, how an egress IPVC EP is chosen from among the IPVC EPs for the IPVC corresponding to the ingress IPVC EP, and finally how a specific UNI Access Link or ENNI Link is selected from among those in the UNI or ENNI where the egress IPVC EP is located. This section summarizes how these attributes are used together (the normative definitions and requirements can be found later in the document). This description applies to Subscriber IPVCs, and to Operator IPVCs for which the IPVC EPs are all at UNIs or at ENNIs that use Option A.

The IPVC Packet Delivery Service Attribute (section 10.4) is used to select whether packet delivery in an IPVC uses standard IP routing, or some other mechanism such as policy-based routing (i.e., routing based on something other than only the reachability of the destination IP address). When standard IP routing is used, the selection of ingress and egress IPVC EPs and egress UNI Access Links or ENNI Links is based on the reachability of the destination address in the IP Packet.

The IPVC EP Prefix Mapping Service Attribute (section 11.5) is used to restrict which hosts in the Subscriber Network can access an IPVC via an IPVC EP at a given EI. It is either empty (no restrictions), or contains a list of IP Prefixes that describe the set of addresses that can access the IPVC via the IPVC EP.

At an ENNI, the ENNI Peering Type Common Attribute (section 15.2) and the ENNI Type Service Attribute (section 14.2) are used to indicate the peering type (Option A, Option B or Option C) used at the ENNI. The IPVC EP ENNI Service Mapping Identifier Service Attribute (section 11.6) and the ENNI Service Map Common Attribute (section 15.6) are used to assign ENNI Service Mapping Identifiers to IPVC EPs and (for ENNIs using Option A) to assign ENNI Service Mapping Contexts to ENNI Links. In addition, the ENNI Routing Common Attribute (section 15.5) describes how routes advertised across the ENNI are marked to indicate that they are for roots or for leaves, in a rooted multipoint IPVC.

The subsections below describe IP Routing and Packet Delivery for IP Services based on these attributes. Some examples can be found in Appendix B.

Note that definition of Service Attributes related to route manipulation that affects the Subscriber are deferred to a future version of this specification.

### 9.1 IP Routing in an SP or Operator Network

Packet delivery using standard IP routing is described using the concept of routing information databases and routing tables. A routing information database is, essentially, a list of IP Prefixes that represents a set of reachable IP addresses, along with one or more potential next-hops (and other attributes) for each IP Prefix. Each next-hop describes either a next-hop IP address and/or an interface which can be used to reach IP addresses within the IP Prefix. A routing table contains the necessary information from a routing information database that is used for delivering IP Packets.

The specific routing information databases and routing tables described in the following subsections are abstract concepts used to explain the behavior of an IP Service; they do not necessarily reflect the implementation used in the actual devices that implement the service (e.g. PE devices). It is not required that the SP use any particular implementation of routing information databases to implement an IP Service.

The IP Prefixes and their associated nexthops in a routing information database are known as routes. Other information or attributes can also be associated with a route, typically specific to a given routing protocol; this further information is outside the scope of this document. Routes can be added (and changed or removed) from a routing information database in a number of ways:

- Statically configured (i.e., static routing).
- Taken from the IP Address and subnet assigned to a UNI Access Link (i.e. “connected” routes).
- Learned dynamically via a routing protocol or other protocol (e.g. DHCP).
- Propagated from another routing information database.

A route is propagated from one routing information database to another by copying the IP Prefix, and one or more of the nexthops and other information and attributes. The nexthops may be modified, but only such that IP Packets destined for the IP Prefix are delivered via the same egress EI as they would have been according to the information in the routing information database from which the route was propagated. Other information and attributes associated with the route may also be modified.

Routes in a routing information database can be active or inactive. A route where the nexthop is an interface (for example, a connected route) is only active when the nexthop interface is operational. In a routing table, a route where the nexthop is an IP address (e.g. a BGP route) is only active when the routing table also contains an active route for a prefix containing that nexthop IP address.

For the purpose of this document, a “default route” is considered to be represented by the IPv4 Prefix 0/0 or the IPv6 Prefix ::/0. Any reference to an IP Prefix includes the possibility that the prefix is 0/0 or ::/0, unless otherwise stated.

The subsections below describe a number of abstract routing information databases that are used to form routing tables, and hence to describe the overall packet delivery behavior.

### 9.1.1 UNI Routing Information Database

For each UNI, a routing information database, denoted  $RID_{UNI}$ , is maintained which contains routes to prefixes in the Subscriber Network that can be reached over the UNI Access Links in the UNI. These include:

- the IP Prefixes described by the IPv4 and IPv6 Connection Addressing Service Attributes (sections 13.4 and 13.5) for each UNI Access Link in the UNI – these are commonly called “connected routes”.
- the IP Prefixes that are listed for static routing over the UNI (per section 12.7.1).



- the IP Prefixes advertised from the Subscriber Network towards the SP as reachable over the UNI by a dynamic routing protocol (e.g. OSPF or BGP), if one is being used (see sections 12.7.2 and 12.7.3).
- any IP Prefixes dynamically allocated to the Subscriber using DHCPv6 Prefix Delegation over UNI Access Links in the UNI (per section 13.7).

Note that the set of routes in  $RID_{UNI}$  can change over time, particularly if a dynamic routing protocol is used. Note also that the status of a route (active or inactive) can change based on network events, for example if a UNI Access Link becomes non-operational.

### 9.1.2 ENNI Service Mapping Context Routing Information Database

For each ENNI Service Mapping Context at an ENNI using Option A, a routing information database, denoted  $RID_{SC}$ , is maintained which contains routes to prefixes in the Subscriber Network that can be reached over the ENNI Links assigned to that ENNI Service Mapping Context. These comprise:

- IP Prefixes that have been advertised by the peer Operator using eBGP over those ENNI Links (see section 9.2).
- IP Prefixes that are listed for static routing over the ENNI for that ENNI Service Mapping Context (see section 14.3).

In either case, routes that are marked as being for leaves (as described in the ENNI Routing Common Attribute, section 15.5 or the ENNI Routing Information Service Attribute, section 14.3) are not included in  $RID_{SC}$ .

An additional routing information database, denoted  $RID_{SCL}$ , is also maintained, if needed, for each ENNI Service Mapping Context at an ENNI using Option A, containing routes to prefixes in the Subscriber Network that can be reached over the ENNI Links assigned to that ENNI Service Mapping Context and that were marked as being for leaves (as described in the ENNI Routing Common Attribute, section 15.5). This is only needed if there are any IPVC EPs at the ENNI that have *Trunk* role (see section 11.4). As for  $RID_{SC}$ , these are routes that have been advertised by the peer Operator using eBGP over those ENNI Links, or that are listed for static routing for the ENNI Service Mapping Context; the difference is that routes that are marked as being for leaves are added to  $RID_{SCL}$ , whereas routes that are not so marked are added to  $RID_{SC}$ .

Note that the set of routes in  $RID_{SC}$  and  $RID_{SCL}$  can change over time, for example depending on eBGP advertisements and withdrawals. Note also that the status of a route (active or inactive) can change based on network events, for example if an ENNI Link becomes non-operational.

### 9.1.3 IPVC EP Local Routing Information Database

For each IPVC EP at a UNI, for an IPVC that uses standard IP routing (that is, where the IPVC Packet Delivery Service Attribute (section 10.4) is *Standard Routing*), a routing information database, denoted  $RID_L$ , is maintained which contains routes to prefixes in the Subscriber Network that can be reached via the UNI Access Links in the UNI where the IPVC EP is located, and that are permitted for use in the IPVC. Similarly, for each IPVC EP with a given ENNI Service Mapping Context at an ENNI using Option A, for an IPVC that uses standard IP routing, a routing

information database, again denoted  $RID_L$ , is maintained which contains routes to prefixes in the Subscriber Network that can be reached via the ENNI Links with that ENNI Service Mapping Context at the ENNI where the IPVC EP is located, that are not marked as for leaves, and that are permitted for use in the IPVC. If the ENNI has a non-empty  $RID_{SCL}$  (i.e., if it has an IPVC EP with *Trunk* role) for that ENNI Service Mapping Context, a second such routing information database, denoted  $RID_{LL}$ , is maintained which contains routes to prefixes in the Subscriber Network that can be reached via the ENNI Links with that ENNI Service Mapping Context at the ENNI where the IPVC EP is located, that are marked as for leaves, and that are permitted for use in the IPVC.

In other words,  $RID_L$  and  $RID_{LL}$  contains the prefixes for which the IPVC EP can be used as an egress IPVC EP. This is controlled by the IPVC EP Prefix Mapping Service Attribute (section 11.5):

- If the IPVC EP Prefix Mapping Service Attribute is not set (that is, it is an empty list), then  $RID_L$  for the IPVC EP contains all of the active routes in  $RID_{UNI}$  if the IPVC EP is at a UNI, or all of the active routes in  $RID_{SC}$  for the ENNI Service Mapping Context assigned to the IPVC EP, if the IPVC EP is at an ENNI.
- If the IPVC EP Prefix Mapping Service Attribute is set, then  $RID_L$  for the IPVC EP contains the subset of active routes in  $RID_{UNI}$  or  $RID_{SC}$  that have IP Prefixes matching an entry in the IPVC EP Prefix Mapping Service Attribute.
  - If the IP Prefix in an active route is the same as or a subset of an IP Prefix in the IPVC EP Prefix Mapping Service Attribute, the route is propagated directly from  $RID_{UNI}$  or  $RID_{SC}$  to  $RID_L$ .
  - If the IP Prefix in an active route is a superset of an IP Prefix in the IPVC EP Prefix Mapping Service Attribute, a route is created in  $RID_L$  for the IP Prefix in the IPVC EP Prefix Mapping Service Attribute, with the next hop and other attributes derived from the route in  $RID_{UNI}$  or  $RID_{SC}$ . That is, only the subnet(s) of the original route that match the value of the IPVC EP Prefix Mapping Service Attribute are propagated.

For an IPVC EP at an ENNI using Option A,  $RID_{LL}$  is populated in the same way from  $RID_{SCL}$ .

In other words, one of the effects of setting the IPVC EP Prefix Mapping Service Attribute (section 11.5) for a given IPVC EP at an EI is to limit which of the routes towards the Subscriber Network at that EI are available in the IPVC for the IPVC EP. Only IP prefixes that are listed in the IPVC EP Prefix Mapping Service Attribute are exposed to that IPVC. This can be useful in the case of an extranet IPVC, to ensure that only hosts that are intended to be made available to other organizations are reachable via the extranet IPVC. Note that the IPVC EP Prefix Mapping Service Attribute can also affect the IP Packets received at the EI, as described in section 9.3.1 below.

At an ENNI using Option A, for an IPVC EP with a given ENNI Service Mapping Context, only routes received over ENNI Links with that ENNI Service Mapping Context are propagated into  $RID_L$  or  $RID_{LL}$ .

Note that regardless of the value of the IPVC EP Prefix Mapping Service Attribute, only active routes are added to  $RID_L$  or  $RID_{LL}$ .

In a cloud access IPVC, an instance of  $RID_L$  is also maintained for the cloud service, containing all IP Prefixes that are reachable in the cloud service. How the SP determines whether an IP Prefix is reachable in the cloud service is outside the scope of this document.

#### 9.1.4 IPVC EP Remote Routing Information Database

For each IPVC EP for an IPVC that uses standard IP routing (that is, where the IPVC Packet Delivery Service Attribute (section 10.4) is *Standard Routing*), a routing information database, denoted  $RID_R$ , is maintained which contains routes to prefixes in the Subscriber Network that can be reached via other IPVC EPs for the IPVC. For a given IPVC EP,  $RID_R$  is formed by propagating routes from  $RID_L$  and  $RID_{LL}$  for each other IPVC EP for the IPVC, as follows:

- If the IPVC EP has *Root* or *Trunk* role (see section 11.4), then  $RID_L$  and  $RID_{LL}$  (if it exists) for each other IPVC EP for the IPVC are considered.
- If the IPVC EP has *Leaf* role, then  $RID_L$  for each other IPVC EP for the IPVC that has *Root* or *Trunk* Role are considered. Note that  $RID_{LL}$  is not considered for other IPVC EPs that have *Trunk* Role.
- If it is a cloud access IPVC, then  $RID_L$  for the cloud service is also considered.
- For each remote  $RID_L$  or  $RID_{LL}$  considered in the steps above, the active route (or routes) for each IP Prefix are propagated into  $RID_R$  for the IPVC EP. The nexthop information for the routes is modified to reflect the internal routing within the SP or Operator.

In a cloud access IPVC, an instance of  $RID_R$  is also maintained for the cloud, formed by propagating routes from  $RID_L$  for each IPVC EP for the IPVC in a similar way as described above.

Assuming that the IPVC EPs for an IPVC are not all implemented by the same device in the SP or Operator Network, forming  $RID_R$  at a given IPVC EP requires that routes are propagated across the SP or Operator Network from other IPVC EPs. This specification does not define how this is done. *Typically it is achieved using MPLS/BGP VPNs as described in RFC 4364 [31], where each IPVC is represented as a separate BGP VPN, and route targets and optionally other BGP attributes are used appropriately to control the distribution of routes.*

#### 9.1.5 IPVC EP Routing Table

For an IPVC EP for an IPVC that uses standard IP routing (that is, where the IPVC Packet Delivery Service Attribute (section 10.4) is *Standard Routing*), the IPVC EP Routing Table, denoted  $RT_{IPVCEP}$ , is a routing information database that contains all the routes that are reachable from that IPVC EP. It is formed by merging  $RID_L$ ,  $RID_{LL}$  (for an IPVC EP with *Trunk* role) and  $RID_R$  for the IPVC EP, by selecting the best active route (or routes) for each IP Prefix that is contained in either  $RID_L$ ,  $RID_{LL}$  or  $RID_R$ . Note that  $RID_L$  or  $RID_{LL}$  and  $RID_R$  might both contain routes to the same IP Prefix, if it is reachable both via the EI where the IPVC EP is located, and via some other EI that has an IPVC EP for the IPVC. In this case, the best route (or routes) overall for that IP Prefix is added to  $RT_{IPVCEP}$ .

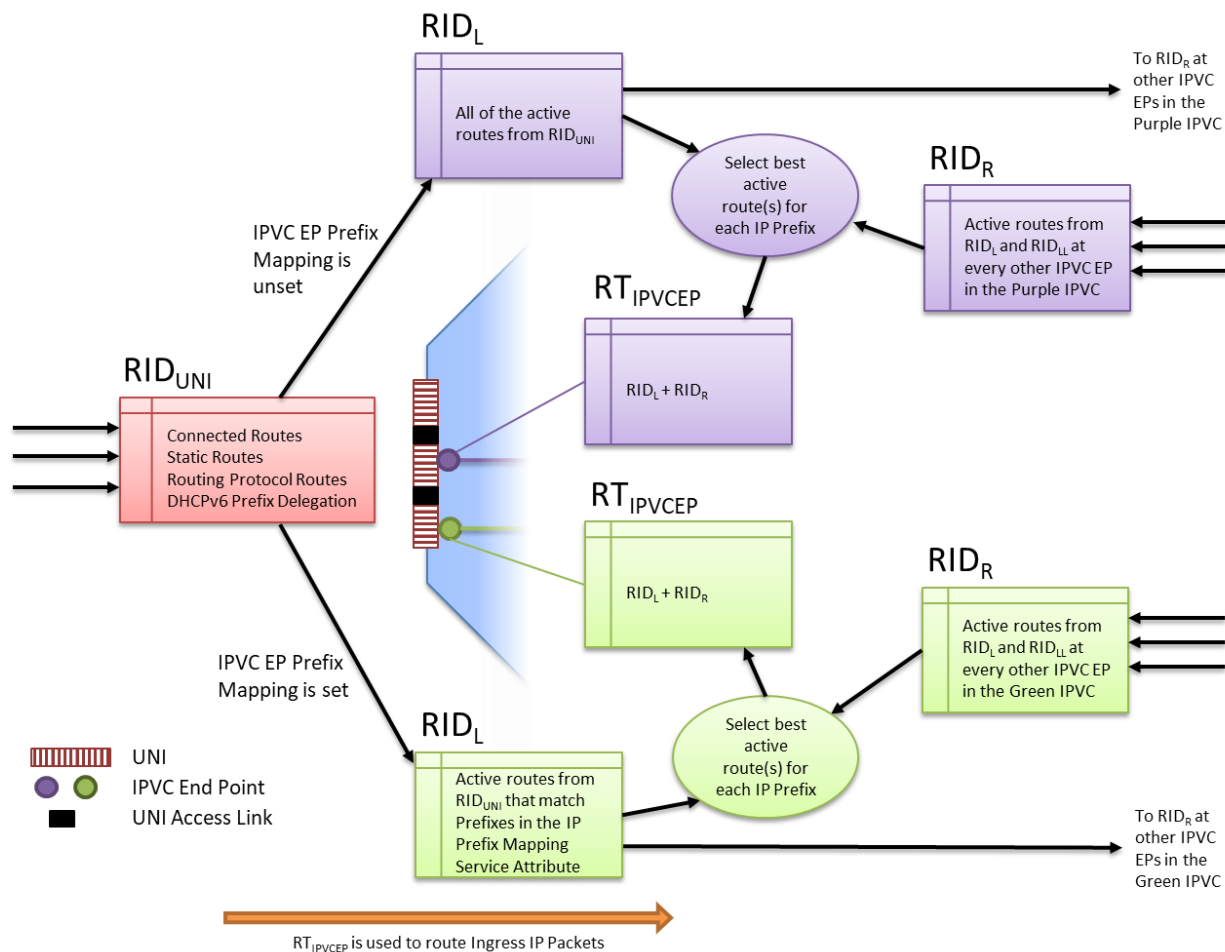
Determining which routes are the best is, in general, beyond the scope of this specification; typically it depends on routing protocol metrics and costs, and the SP's internal routing policies. However, there are some requirements relating to the administrative distance that constrain the choice of best route in certain cases – see sections 12.7, 14.3.1.1, and 15.5.

Note that as  $RID_L$ ,  $RID_{LL}$  and  $RID_R$  only contain active routes,  $RT_{IPVCEP}$  also only contains active routes.

Again, in a cloud access service there is an instance of  $RT_{IPVCEP}$  for the cloud service, formed by merging  $RID_L$  and  $RID_R$  for the cloud service. Note that there is no IPVC EP at the interface between the SP and the cloud service; however, for convenience we use the same terminology to refer to the routing table  $RT_{IPVCEP}$ .

### 9.1.6 Summary

Figure 21 illustrates the flow of routes between the various routing information databases described above, in the case of a UNI. It shows a single UNI containing two UNI Access Links and that has two IPVC EPs (for two different IPVCs), both of which have *Root* role.



**Figure 21 – Routing Information Databases at a UNI (IPVC EPs with *Root* role)**

Note that as illustrated in Figure 21,  $RID_{UNI}$  contains routes over both the UNI Access Links. It is not possible to restrict the propagation of routes from  $RID_{UNI}$  into  $RID_L$  for a given IPVC EP based on the UNI Access Link the route points to or was received over; restricting the routes is only possible based on the target IP Prefix, using the IPVC EP Prefix Mapping Service Attribute. If it is desired to distinguish between UNI Access Links, they can be placed in different UNIs.

$RT_{IPVCEP}$  for each IPVC EP is formed by combining  $RID_R$  and  $RID_L$ . As described in section 9.3, it is used to help select an IPVC EP for Ingress IP Packets at the UNI, and to then route them over the IPVC.

If one of the IPVC EPs had *Leaf* role, the differences would be that only routes from  $RID_L$  at other IPVC EPs with *Root* or *Trunk* role would be propagated into  $RID_R$  for the IPVC EP. Similarly, routes in  $RID_L$  for the IPVC EP would only be propagated to other IPVC EPs for the IPVC that had *Root* or *Trunk* role.

At an ENNI using Option A, the flow of routes is similar, except that the source on the left is the set of routes over ENNI Links with a given ENNI Service Mapping Context ( $RID_{SC}$ ), rather than the set of routes over the UNI Access Links in a given UNI ( $RID_{UNI}$ ), and there may be a second flow involving  $RID_{SCL}$  and  $RID_{LL}$  for routes marked as being for leaves. An example is shown in Figure 22, with a single IPVC EP for the ENNI Service Mapping Context, which has *Root* or *Trunk* role.

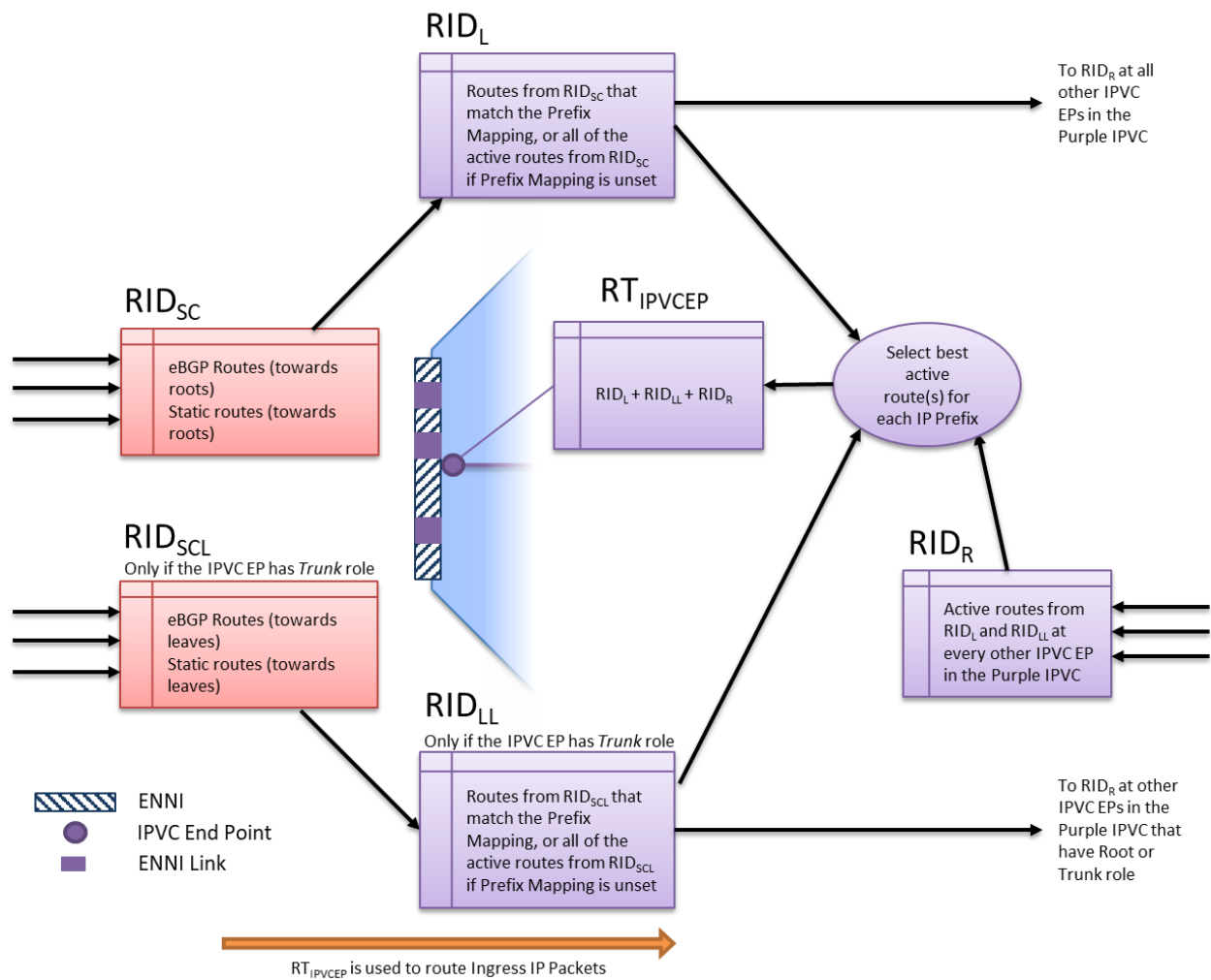


Figure 22 – Routing Information Databases at an ENNI

$RT_{IPVCEP}$  for an IPVC EP is formed by combining  $RID_R$ ,  $RID_L$  and  $RID_{LL}$ . As described in section 9.3, it is used to help select an IPVC EP for Ingress IP Packets at the ENNI, and to then route them over the IPVC.

Again, if the IPVC EP instead had leaf role, the differences would be that only routes from  $RID_L$  at other IPVC EPs with *Root* or *Trunk* role would be propagated into  $RID_R$  for the IPVC EP; and routes in  $RID_L$  for the IPVC EP would only be propagated to other IPVC EPs for the IPVC that had *Root* or *Trunk* role.

In both the above cases – at a UNI or at an ENNI – it can be seen that the SP or Operator must distribute routes between the IPVC EPs for an IPVC, in order to populate  $RID_R$  at each IPVC EP from  $RID_L$  (and if appropriate  $RID_{LL}$ ) at all other IPVC EPs. How this is achieved is not limited by this specification and any method that yields the required behavior is acceptable. *However, it is noted that this is typically achieved using MPLS/BGP VPNs per RFC 4364 [31], where each IPVC is represented as a separate BGP VPN, and route targets and optionally other BGP attributes are used appropriately to control the distribution of routes.*

The description above results in a separate instance of  $RT_{IPVCEP}$  for each IPVC EP at a UNI (recall each IPVC EP is for a different IPVC) and similarly a separate instance of  $RT_{IPVCEP}$  for each IPVC EP with a given ENNI Service Mapping Context at an ENNI using Option A (again each IPVC EP is for a different IPVC). As described below, this routing table is used to select the IPVC EP to which to map an Ingress IP Packet, and is subsequently used to deliver the packet across the IPVC. However, implementations are not required to actually maintain separate routing tables for each IPVC EP, so long as the externally visible behavior is as described. *Typically, a UNI is associated with a particular routing table (i.e., a VRF) containing routes for all of the IPVCs it belongs to, with routes for different IPVCs distinguished, where necessary, by other attributes (for example, route targets).*

## 9.2 IP Routing Across an ENNI

At an ENNI using Option A, a separate BGP session is maintained over every ENNI Link, as described in section 15.5. The routes advertised over an ENNI Link are determined by considering all the routes in  $RID_R$  for the IPVC EPs with an ENNI Service Mapping Context that matches the ENNI Service Mapping Context assigned to the ENNI Link via the ENNI Service Map Common Attribute (section 15.6).

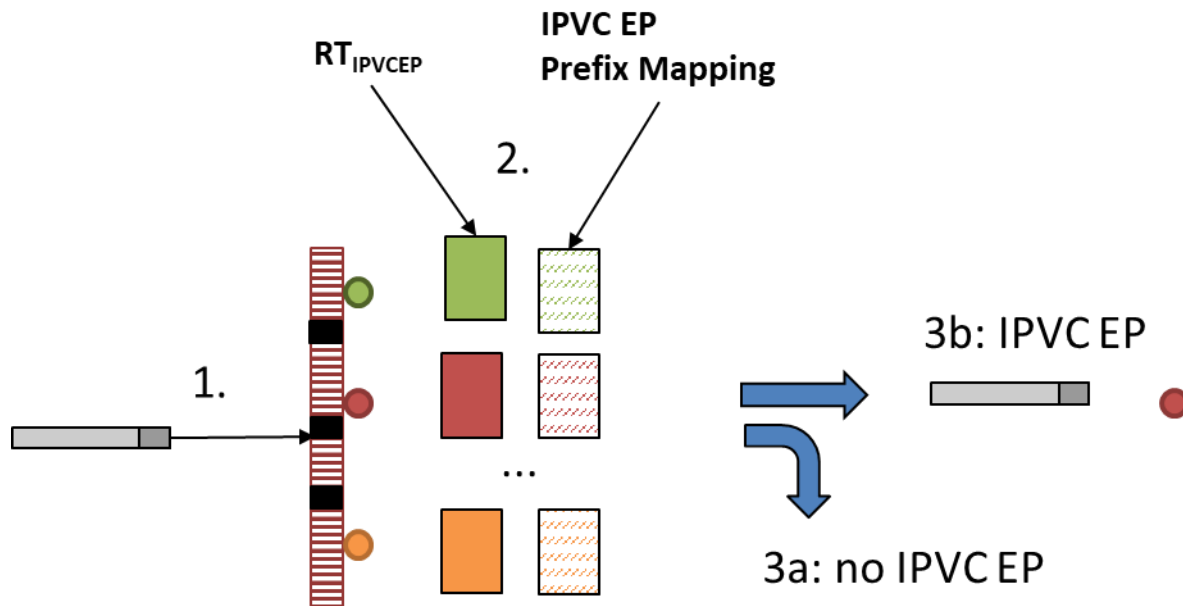
If an IPVC EP with an ENNI Service Mapping Context that matches the ENNI Service Mapping Context assigned to the ENNI Link has *Trunk* role (see section 11.4), then some of the routes may need to be marked as being for leaves, as described in section 15.5. A route in  $RID_R$  for an IPVC EP with *Trunk* role is marked as being for a leaf when it is advertised over the ENNI Link if:

- It was propagated into  $RID_R$  for this IPVC EP from  $RID_L$  for an IPVC EP with *Leaf* role.
- It was propagated into  $RID_R$  for this IPVC EP from  $RID_{LL}$  for an IPVC EP IP with *Trunk* role.

In all other cases, the route is not marked as being for a leaf.

### 9.3 IP Packet Delivery

The subsections below describe the two stages in IP Packet Delivery: first selecting an IPVC EP at the ingress EI, and secondly delivering the IP Packet over the IPVC. Both these stages use information from  $RT_{IPVCEP}$ ; selecting an IPVC EP also uses the IPVC EP Prefix Mapping Service Attribute. The process is illustrated in Figure 23.



**Figure 23 – IP Packet Delivery overview**

As shown, when a packet arrives at an EI (1), it is matched against the  $RT_{IPVCEP}$  and the IPVC EP Prefix Mapping for each IPVC EP (2). If there are no matches, the packet is not forwarded across an IPVC (3a); otherwise, it is forwarded based on the information in the selected  $RT_{IPVCEP}$  (3b). This process is described further in the subsections below.

#### 9.3.1 Selecting an Ingress IPVC EP

The first stage in packet delivery is to determine the right IPVC EP at the ingress EI. The subsections below describe how this is done at a UNI and at an ENNI.

##### 9.3.1.1 Selecting an Ingress IPVC EP at a UNI

At a UNI, IPVC EP selection is done primarily by examining the  $RT_{IPVCEP}$  routing table for each of the IPVC EPs at the UNI, to see if it contains an active route matching the destination address in the packet, and if so, whether it is the most specific matching route (that is, the route with a matching prefix that has the longest prefix length).

In addition, the IPVC EP Prefix Mapping Service Attribute (section 11.5) is also used (if set) during the ingress IPVC EP selection, to filter out packets that should be excluded from the IPVC. If the IPVC EP Prefix Mapping Service Attribute is non-empty, then the IPVC EP can only be selected for Ingress IP Packets with a source address within one of the IP Prefixes in the attribute.

In certain cases, the IPVC EP Prefix Mapping Service Attribute must be properly set to make the IPVC EP selection possible.

Note that the effect of the IPVC EP Prefix Mapping Service Attribute described here is different to the effect it has on routing, as described in section 9.1.2. As described above, one case where this can be useful is in the case of an extranet IPVC, to limit the Ingress IP Packets that can access the IPVC for the extranet to only those originating at hosts that are intended to be exposed to other organizations.

The IPVC EPs present at a given UNI (which are necessarily for different IPVCs) may have the following relationships:

1. The UNI has only a single IPVC EP.
2. Multiple IPVC EPs are sharing the UNI, and routing of the corresponding IPVCs is:
  - a. Non-overlapping: each IPVC has routes for different IP Prefixes.
  - b. Overlapping: at least some of the same routes/IP Prefixes are used by multiple IPVCs.

In the first two cases (1 and 2a), a single IPVC EP can be selected based on route lookup(s) in the RT<sub>IPVCEP</sub> table(s). The role of the IPVC EP Prefix Mapping (if set) is simply to filter out unwanted packets.

However the case of overlapping IPVC EPs (case 2b) is more complex. There are two further sub-cases:

- i. The egress EI to which an ingress IP Packet should be delivered can be determined solely by longest match routing based on the destination address.
- ii. The egress EI to which an ingress IP Packet should be delivered depends on both the routing based on the destination address, and on matching the source address in the packet against the IPVC EP Prefix Mapping Service Attribute for the IPVC EPs.

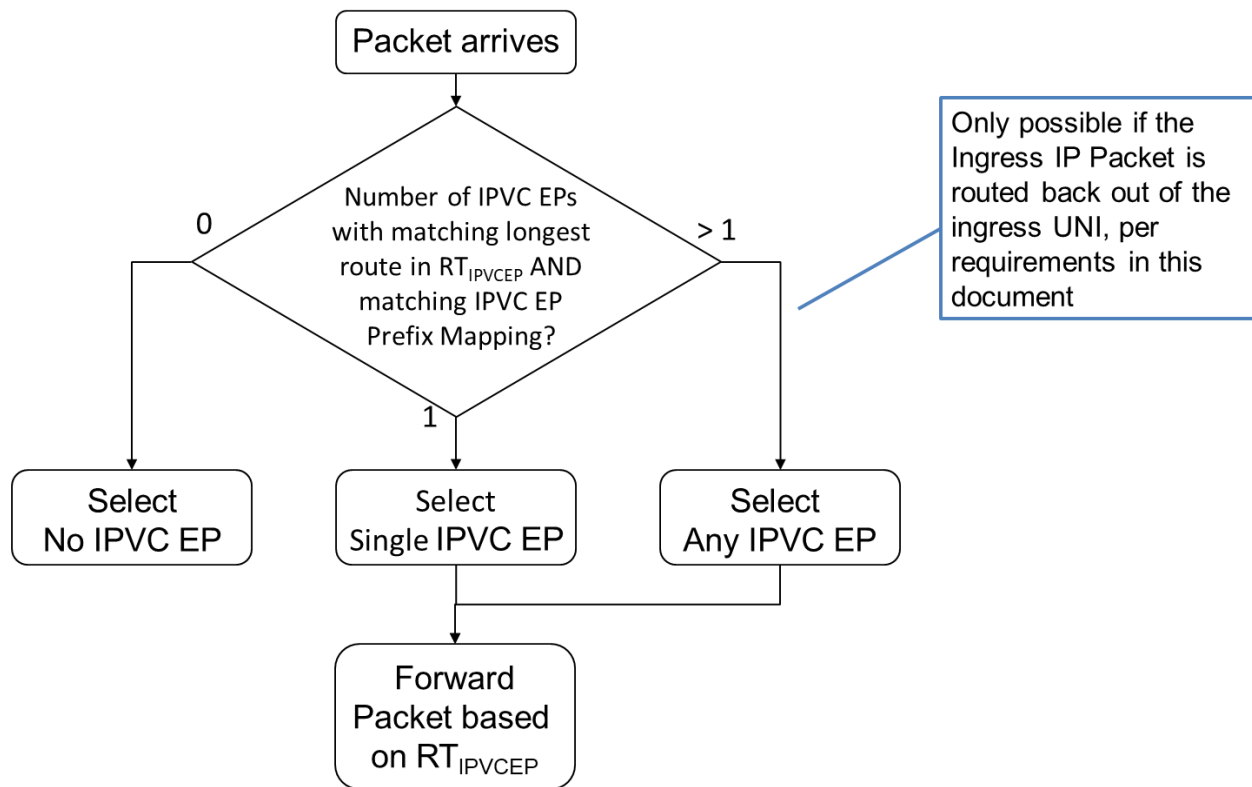
In both cases (i) and (ii), the IPVC EP Prefix Mapping Service Attribute for each IPVC EP is directly involved in the ingress IPVC EP selection, and therefore the values of the IP Prefix Mapping Service Attribute must be non-overlapping, such that a single IPVC EP can be deterministically selected. However, in case (i), this does not affect the egress EI to which the packet is delivered, whereas in case (ii), it may do.

Implementing case (ii) requires more advanced capabilities in the Service Provider or Operator (i.e., routing based on more than just the destination address), which might not be supported. If such capabilities are not supported, the requirements in this specification ensure that case (ii) is avoided. This is achieved by mandating, in this case, that the Subscriber IPVCs agreed between a Subscriber and an SP are such that if two IPVC EPs at a given UNI both have a route to a given IP Prefix, it is a route via the same egress UNI in both IPVCs. Similarly, it is mandated that the Operator IPVCs agreed between an SP/SO and an Operator are such that if two IPVC EPs at a given UNI both have a route to a given IP Prefix, it is a route via the same egress EI in both IPVCs.

The behavior and requirements if case (ii) is supported by the SP or Operator are outside the scope of this document, and may be specified in a future revision.



The overall process (applicable to all the cases above) is illustrated in Figure 24.



**Figure 24 – Selecting an Ingress IPVC EP**

In the case where two or more IPVC EPs both have the most specific matching route to a given destination address, and at least one of these routes is towards a UNI Access Link or ENNI Link in a different EI to the one where the Ingress IP Data Packet has been received, the requirements of this specification mean that the IPVC EPs always have non-empty, non-overlapping values for the IPVC EP Prefix Mapping Service Attribute. This means an IPVC EP can be uniquely chosen using the values of the prefix mapping attribute.

In case (i) described above, the requirements of this specification mean that the routes in the different IPVC EPs must all point to the same egress EI – that is, they must result in traffic for that destination being directed out of a UNI Access Link in the same egress UNI or an ENNI Link in the same ENNI that has the same ENNI Service Mapping Context, regardless of which IPVC EP it is mapped to on ingress.

These constraints allow for the following possibilities for a given IP Prefix, at a UNI where all of the attached IPVCs use standard routing, and with reference to the routing tables described above.

- None of the IPVC EPs have a route to the IP Prefix in their  $RT_{IPVCEP}$ .
- Exactly one of the IPVC EPs has a route to the IP Prefix in its  $RT_{IPVCEP}$ .
- Two or more of the IPVC EPs have a route to the IP Prefix in their  $RT_{IPVCEP}$ , and the best active route in at least one of these points to a UNI Access Link in a remote UNI or an ENNI Link in an ENNI – that is, it comes from a route in  $RID_R$ . In addition, all of the

IPVC EPs have the IPVC EP Prefix Mapping attribute set, with disjoint lists of IP Prefixes.

- Two or more of the IPVC EPs have a route to the IP Prefix in their  $RT_{IPVCEP}$ , and the best active route in all of these points to a UNI Access Link in the UNI where the IPVC EPs are located – that is, it comes from a route in  $RID_L$ .

Given this, an ingress IPVC EP can be chosen for Ingress IP Data Packets as follows:

- When a unicast Ingress IP Data Packet is received at a UNI, the destination IP address in the packet is looked up in the  $RT_{IPVCEP}$  routing table for each of the IPVC EPs at the UNI, to see if there is a matching route.
- If none of the IPVC EPs have a route in their  $RT_{IPVCEP}$  matching the destination address in the packet, the packet is not mapped to any IPVC EP.
- Otherwise, the IPVC EPs that have the most specific such route (that is, with the longest prefix length) are considered. Any IPVC EPs that have a route that is less specific than the route in another IPVC EP are not considered further.
- For each of the IPVC EPs, if the IPVC EP Prefix Mapping Service Attribute is not an empty list, and the source address in the packet does not match any of the IP Prefixes listed in the value of the attribute, remove the IPVC EP from consideration.
- If there is exactly one IPVC EP still under consideration, then the packet is mapped to this IPVC EP. This can be the case if:
  - Only one IPVC EP had the most specific route (or perhaps any route at all) matching the destination address in the packet, and that IPVC EP had an empty list for the IPVC EP Prefix Mapping Service Attribute.
  - Only one IPVC EP had the most specific route (or perhaps any route at all) matching the destination address in the packet, that IPVC EP had a non-empty value for the IPVC EP Prefix Mapping Service Attribute, and the source address in the packet matched one of the IP Prefixes in the attribute value.
  - More than one IPVC EP had the most specific route matching the destination address in the packet, all of them had a non-empty value for the IPVC EP Prefix Mapping Service Attribute, but the source address in the packet matched an IP Prefix in the attribute value for only one of the IPVC EPs.
- If there is more than one IPVC EP still under consideration, then the packet is mapped to any one of them. This can only be the case if more than one IPVC EP had the most specific route matching the destination address in the packet, all those routes pointed to UNI Access Links in the ingress UNI, and for each of the IPVC EPs, either the IPVC EP Prefix Mapping Service Attribute was an empty list, or the source address in the packet matched one of the IP Prefixes listed in the attribute.

In the case where multiple IPVC EPs have a route to the destination address, the selection of a particular IPVC EP to which to map an Ingress IP Packet can affect the attributes that apply to it (for example, which Ingress Class of Service Map applies (see section 11.9) and which SLS objectives apply (see section 10.9)). In case (i) described above, it does not affect the egress EI that the packet will be transmitted over, because the routes in all the possible IPVC EPs are required to be such that the egress EI is the same (see section 11.5.1). This requirement enables implementations to use a single routing table for all IPVC EPs at a UNI, or to perform routing lookups before determining the IPVC EP. However, this specification does not constrain implementations and

any implementation exhibiting the required behavior is acceptable. In particular, routing based on the source IP address or other fields is not precluded, and the routes taken within the SP or Operator Network by packets for different IPVCs may be different even if the packets are eventually transmitted out of the same egress EI.

Note that an Ingress IP Data Packet does not have to be discarded if it cannot be mapped to any IPVC EP; it could, for example, be mapped to some other type of service (e.g. a Platform-as-a-Service or Software-as-a-Service service) and hence delivered or consumed by some other means.

The above process can only be followed when all of the IPVC EPs at a UNI are for IPVCs that use standard IP routing (that is, have the IPVC Packet Delivery Service Attribute (section 10.4) set to *Standard Routing*), as otherwise they might not maintain an  $RT_{IPVCEP}$  routing table. When this is not the case – that is, when there is an IPVC EP at the UNI for an IPVC that does not use standard routing – mapping of Ingress IP Packets to IPVC EPs is beyond the scope of this document (but could be addressed in a future version).

The mechanism by which IP Packets received from a cloud service are mapped to the correct cloud access IPVC are beyond the scope of this document. However, a similar process to that described above could be used, by considering the  $RT_{IPVCEP}$  for the cloud service, across every cloud access IPVC supported by the SP.

It is important to note that the IPVC EP Prefix Mapping Service Attribute (further described in section 11.5) has two separate effects, when non-empty:

- It prevents **Ingress** IP packets at a given UNI with a source address that is not in one of the listed IP Prefixes being mapped to the IPVC EP. This has two impacts, both affecting the data plane:
  - If the source address in an Ingress IP Packet at the UNI is not included in the IPVC EP Prefix Mapping for any of the IPVC EPs through which the packet's destination is reachable, then the packet is discarded (or more accurately, it is not mapped to any IPVC EP) – in other words, the union of the Prefix Mapping for all of the IPVC EPs at a UNI acts as a source address filter on Ingress IP Packets.
  - If the destination address in an Ingress IP Packet is reachable via multiple IPVC EPs at a given UNI, the IPVC EP Prefix Mapping affects which IPVC EP the packet is mapped to.
- It prevents IP Packets that are not destined for an address in one of the listed IP Prefixes being transmitted as **Egress** IP Packets at this UNI (via the IPVC EP).
  - For IPVCs that use standard routing, this is done by limiting which IP Prefixes that are reachable over a given UNI (that is, that are present in  $RID_{UNI}$ ) are made available in the IPVC for the IPVC EP. Only IP Prefixes listed in the attribute are exported into the IPVC. This behavior is in the control plane in the SP or Operator (i.e., the propagation of routing information); it therefore affects whether IP Packets received at other EIs can be mapped to the IPVC at all. There is no need for data plane filtering of the Egress IP Packets (although this is not precluded), as the destination prefixes are not reachable.
  - For IPVCs that use policy-based routing, the same can be done, but data plane filtering of the Egress IP Packets may also be needed.

*The control plane aspect of the IPVC EP Prefix Mapping Service Attribute behavior can be implemented, for example, by appropriate use of BGP Route Targets, and other than in case (ii) above, the data plane aspect can be implemented, for example, using QoS policies and/or access control lists (ACLs) that match on the source and destination addresses in IP Packets. Other than in case (ii), the constraints in this specification ensure that it is not necessary to consider the source IP address to determine how to route packets. In all cases, the implementation of any aspect of the behavior is not constrained by this implementation and any implementation that exhibits the required behavior is acceptable.*

Note that the IPVC EP Prefix Mapping Service Attribute is unrelated to the use of Reverse Path Forwarding (RPF), but can be used in combination with it. The IPVC EP Prefix Mapping Service Attribute is a static list that limits, as a matter of policy, the IP Prefixes that can access a particular IPVC that is attached to the UNI – i.e., it affects a particular IPVC EP. RPF checks (as described in RFC 3704 [25]) use dynamic reachability information to filter out IP Packets that appear to have a spoofed source IP address, and affect the UNI as a whole. RPF checks can be enabled using the UNI Reverse Path Forwarding Service Attribute (section 12.8).

### **9.3.1.2 Selecting an Ingress IPVC EP at an ENNI**

At an ENNI using Option A, IPVC EP selection is done by considering the IPVC EPs that have the ENNI Service Mapping Context that is assigned to the ENNI Link over which the packet was received. This specification only covers the case where there is at most one such IPVC EP; the behavior and requirements when there is more than one IPVC EP with a given ENNI Service Mapping Context at an ENNI are out of scope (but may be specified in a future revision).

In addition, the IPVC EP Prefix Mapping Service Attribute (section 11.5) is also used (if set) during the ingress IPVC EP selection, to filter out packets that should be excluded from the IPVC. If the IPVC EP Prefix Mapping Service Attribute is non-empty, then the IPVC EP can only be selected for Ingress IP Packets with a source address within one of the IP Prefixes in the attribute.

Given the constraint that there is at most one IPVC EP with a given ENNI Service Mapping Context at an ENNI, an ingress IPVC EP can be chosen for an Ingress IP Data Packet at an ENNI as follows, assuming the ENNI uses Option A and the IPVCs attached to the ENNI use standard routing:

- If there is no IPVC EP that has the same ENNI Service Mapping Context as the ENNI Link the packet was received over, the packet is not mapped to any IPVC EP.
- Otherwise, there is a single IPVC EP with the same ENNI Service Mapping Context as the ENNI Link the packet was received over (as other cases are out of scope). The destination IP address in the packet is looked up in the  $RT_{IPVCEP}$  routing table for the IPVC EP, to see if there is a matching route.
- If the IPVC EP does not have a route in its  $RT_{IPVCEP}$  matching the destination address in the packet, the packet is not mapped to any IPVC EP.
- If the IPVC EP Prefix Mapping Service Attribute for the IPVC EP is not an empty list, and the source address in the packet does not match any of the IP Prefixes listed in the value of the attribute, the packet is not mapped to any IPVC EP.
- Otherwise, the packet is mapped to the IPVC EP.

In other words, an Ingress IP Data Packet at an ENNI using Option A is mapped to the IPVC EP with the same ENNI Service Mapping Context as the ENNI Link the packet was received over (if there is one), provided that the IPVC EP has a route in its  $RT_{IPVCEP}$  matching the destination address in the packet, and either the IPVC EP Prefix Mapping Service Attribute is an empty list, or the source address in the packet matches one of the IP Prefixes listed in the value of the attribute. Otherwise, the packet is not mapped to any IPVC EP.

Note that an Ingress IP Data Packet does not have to be discarded if it cannot be mapped to any IPVC EP; it could, for example, be mapped to some other type of service and hence delivered or consumed by some other means.

The above process can only be followed when the IPVC EP with a given ENNI Service Mapping Context at an ENNI is for an IPVC that uses standard IP routing (that is, has the IPVC Packet Delivery Service Attribute (section 10.4) set to *Standard Routing*), as otherwise the IPVC EP might not maintain an  $RT_{IPVCEP}$  routing table. When this is not the case, mapping of Ingress IP Packets to IPVC EPs at an ENNI is beyond the scope of this document (but could be addressed in a future version).

### 9.3.2 Delivering IP Packets across an IPVC

Once an ingress IPVC EP has been selected, this identifies the IPVC that is used to deliver the IP Packet. Assuming the IPVC uses standard IP routing (that is, it has the IPVC Packet Delivery Service Attribute (section 10.4) set to *Standard Routing*), this means there is at least one active route in  $RT_{IPVCEP}$  at the ingress IPVC EP that matches the destination address in the IP Packet. However, there could be more than one such route:

- There could be multiple IP Prefixes in the routing table that match the destination address. In this case, the most specific IP Prefix is used (i.e. “longest prefix matching”).
- There could be multiple paths to reach the IP Prefix. In this case, the best path is chosen. How the best path is determined is outside the scope of this document, and typically depends on routing protocol metrics and costs.

In the latter case, it is also possible that different paths are selected for different packets that match the same IP Prefix, for example using Equal Cost Multipath (ECMP). In this case, care is needed to ensure that packets within a given flow are not re-ordered as they traverse the IPVC.

Note that the distribution of routing information ensures that the destination can only be reachable via an EI that has an IPVC EP in the same IPVC as the ingress IPVC EP, and that in the case of a rooted multipoint IPVC (see section 10.2), if the ingress IPVC EP has *Leaf* role, the destination is not reachable via an EI that has another IPVC EP with *Leaf* role.

*For a Subscriber IP Service, when a route is selected from  $RT_{IPVCEP}$  at the ingress IPVC EP, the SP is responsible for ultimately delivering the IP Packet over a corresponding egress UNI Access Link towards the Subscriber, or in a Cloud Access service, delivering the IP Packet to the cloud service. It might be that the route in  $RT_{IPVCEP}$  at the ingress IPVC EP includes sufficient information to identify the egress UNI Access Link (along with the appropriate nexthop information in the Subscriber Network) or cloud service. Alternatively, it may only identify a point within the SP*

*Network (for example, the egress UNI or a remote PE device), with further routing lookups performed at that point. In this case, the information about the egress UNI Access Link or cloud service does not all need to be known at the ingress UNI. This specification does not constrain the implementation of the service by the SP; any implementation that ensures that packets are delivered using the best route is acceptable. Similar comments apply to an Operator IP Service.*

## 9.4 IP Data Packet Transparency

In general, an IPVC conveys IP Packets without modifying the contents; however, there are some exceptions:

- The TTL/Hop Limit field is decremented by at least 1.
- The DS (RFC 3260 [22]) and ECN (RFC 3168 [21]) fields can be modified
- IPv4 packets can be fragmented.
- The value of IPv6 Hop-by-Hop options with an option type that has the third high-order bit set can be modified.
- The Loose Source and Record Route, the Strict Source and Record Route, and the Record Route options in an IPv4 packet can be modified, and if either of the first two are present, the destination address can also be modified. (RFC 791 [1]).
- The IPv4 header checksum can be updated to reflect changes in other IPv4 header fields.

An IP Service is generally concerned only with the transport of IP Packets across the IPVC; however, the SP and the Subscriber might also agree on other “value-add” services on top of an IP Service (for instance, Security as a Service (SECaaS)), which could modify the contents of an IP Packet. The details of such services are outside the scope of this document.

These exceptions are captured in the following requirements:

**[R1]** If an Ingress IPv4 Data Packet is mapped to an IPVC and delivered as a Egress IPv4 Data Packet, and the packet has not been fragmented as described in RFC 791 [1], the Egress IPv4 Data Packet **MUST** be identical to the Ingress IPv4 Data Packet except that the following fields in the IPv4 header can be changed, and other changes can be made as described in [O1]:

- The TTL field (RFC 791 [1]).
- The DS (RFC 3260 [22]) and ECN (RFC 3168 [21]) fields.
- The Loose Source and Record Route option, the Strict Source and Record Route option, and the Record Route option, if present in the packet (RFC 791 [1]).
- The Destination Address field, if the Loose Source and Record Route option or the Strict Source and Record Route option are present in the packet (RFC 791 [1]).
- The Header Checksum field (RFC 791 [1]).
- Any other field(s), subject to agreement between the Subscriber and the SP (for a Subscriber IP Service) or between the SP/SO and the Operator (for an Operator IP Service).

**[R2]** If an Ingress IPv4 Data Packet is mapped to an IPVC and is fragmented by the SP as described in RFC 791 [1] resulting in a number of corresponding IPv4 Packets that are delivered as Egress IPv4 Packets, the Egress IPv4 Data Packets **MUST** be such that reassembly as described in RFC 791 [1] results in an IP Packet that is identical to the Ingress IPv4 Data Packet except that the following fields in the IPv4 header can be changed, and other changes can be made as described in [O1]:

- The TTL field (RFC 791 [1]).
- The DS (RFC 3260 [22]) and ECN (RFC 3168 [21]) fields.
- The Loose Source and Record Route option, the Strict Source and Record Route option, and the Record Route option, if present in the packet (RFC 791 [1]).
- The Destination Address field, if the Loose Source and Record Route option or the Strict Source and Record Route option are present in the packet (RFC 791 [1]).
- The Header Checksum field (RFC 791 [1]).
- Any other field(s), subject to agreement between the Subscriber and the SP (for a Subscriber IP Service) or between the SP/SO and the Operator (for an Operator IP Service).

**[O1]** In a cloud access IPVC (section 10.2), if Cloud Network Address Translation (section 10.13.4) is not *Disabled*, fields in the IPv4 Packet header, and/or the IPv4 Packet data **MAY** be changed if necessary for the correct operation of the NAT.

The fields that may be modified per [O1] include, for example, the source and destination addresses in the IPv4 header, the source and destination port numbers and the checksum in the TCP or UDP header (if the IPv4 Packet contains a TCP or UDP datagram), the contents of an ICMP datagram (see RFC 3022 [18]) or the contents of a DNS PDU (see RFC 2694 [16]).

**[R3]** If an Ingress IPv6 Data Packet is mapped to an IPVC and delivered as an Egress IPv6 Data Packet, the Egress IPv6 Data Packet **MUST** be identical to the Ingress IPv6 Data Packet except that the following fields in the IPv6 header can be changed:

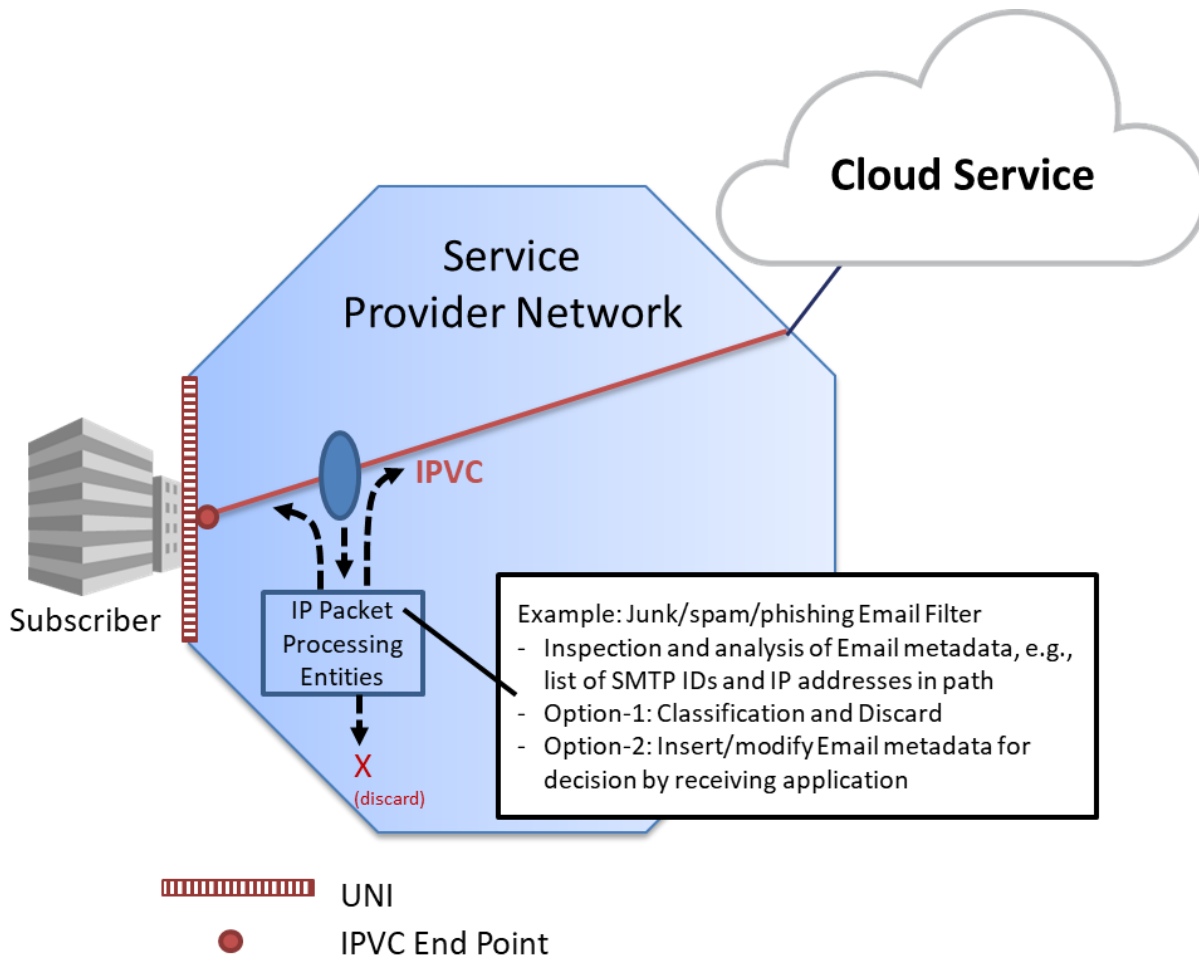
- The Hop Limit field (RFC 8200 [57]).
- The DS (RFC 3260 [22]) and ECN (RFC 3168 [21]) fields.
- The value of any options within a Hop-by-Hop Options header (if present) that have the third high-order bit in the option type field set (RFC 8200 [57]).
- Any other field(s), subject to agreement between the Subscriber and the SP (for a Subscriber IP Service) or between the SP/SO and the Operator (for an Operator IP Service).

Note that modifications to the DS field can be further restricted according to the IPVC DSCP Preservation Service Attribute (see section 10.7).

The use of the Loose Source and Record Route option, the Strict Source and Record Route option, and the Record Route option in IPv4 packets can cause problems due to the additional processing needed at each hop along the path. In addition, the Loose Source and Record Route option and the Strict Source and Record Route option open up a number of potential security risks, as documented in RFC 6274 [46], which outweigh any legitimate use.

**[O2]** A Service Provider or Operator **MAY** discard Ingress IPv4 Packets that contain the Loose Source and Record Route option, the Strict Source and Record Route option, or the Record Route option.

The requirements above allow any field to be changed subject to agreement between the SP and the Subscriber (for a Subscriber IP Service) or between the SP/SO and the Operator (for an Operator IP Service). This is intended to allow for “bump-in-the-wire” services (for example an application-level gateway or proxy service), which could modify certain packets, as shown in Figure 25. Note that such application-layer services are separate to the connectivity provided by the IP Service, but could be offered as a bundle by the SP.



**Figure 25 – Example of a Bump-in-the-Wire Service**



## 10 IPVC Service Attributes

This section specifies Service Attributes for IP Services that apply to the IPVC as a whole. There is one instance of these attributes for each IPVC supported by the SP or Operator. These attributes apply to both Subscriber IPVCs and Operator IPVCs unless otherwise stated. In the case of a Subscriber IP Service, the Service Attributes are agreed between the Subscriber and an SP, and the SP has responsibility for delivering the service (i.e. most requirements are on the SP). In the case of an Operator IP Service, the Service Attributes are agreed between an SP/SO and an Operator, and the Operator has responsibility for delivering the service (i.e. most requirements are on the Operator). The attributes are summarized in Table 3 and described in more detail in the following subsections.

Attribute Name	Summary Description	Possible Values
IPVC Identifier	Unique identifier for the IPVC for management purposes.	Printable string that is unique across the SP's or Operator's network.
IPVC Topology	An indication of the way that IPVC EPs for the IPVC are connected together.	<i>Multipoint, Rooted Multipoint or Cloud Access.</i>
IPVC End Point List	List of IPVC EPs for the IPVC.	List of IPVC EP identifiers.
IPVC Packet Delivery	Indicates whether packets are delivered per standard IP routing behavior or by some other means.	<i>Standard Routing or Policy-Based Routing.</i>
IPVC Maximum Number of IPv4 Routes	Maximum number of IPv4 routes supported by the service as a whole.	Integer $\geq 0$ or <i>Unlimited.</i>
IPVC Maximum Number of IPv6 Routes	Maximum number of IPv6 routes supported by the service as a whole.	Integer $\geq 0$ or <i>Unlimited.</i>
IPVC DSCP Preservation	Indicates whether the SP or Operator is allowed to modify the value of the IP DS field in the IP header of the Subscriber's traffic as it traverses the IPVC.	<i>Enabled or Disabled.</i>
IPVC List of Class of Service Names	List of CoS Names supported by the IPVC.	List of string names.
IPVC Service Level Specification	Set of performance objectives for each CoS Name in the IPVC.	<i>None</i> , or a set of objectives as described in section 10.9.
IPVC MTU	Maximum size (in octets) of an IP Packet that can traverse the IPVC without fragmentation.	Integer $\geq 576$ .
IPVC Path MTU Discovery	Indicates whether Path MTU Discovery is supported for the IPVC.	<i>Enabled or Disabled.</i>
IPVC Fragmentation	Indicates whether IPv4 Packets can be fragmented.	<i>Enabled or Disabled.</i>

Attribute Name	Summary Description	Possible Values
IPVC Cloud	For cloud access services, details of the cloud service being accessed.	<i>None</i> , or parameters for the cloud service as described in section 10.13.
IPVC Reserved Prefixes	IP Prefixes reserved for use by the SP or Operator.	List of IP Prefixes.

**Table 3 – IPVC Service Attributes**

### 10.1 IPVC Identifier Service Attribute

The IPVC Identifier is a unique string identifier for the IPVC. For a Subscriber IP Service, it can be used by the Subscriber and the SP to identify the service to each other. For an Operator IP Service, it can be used by the SP/SO and the Operator to identify the service to each other.

- [R4] The IPVC Identifier **MUST** consist only of ASCII characters in the range 32-126 inclusive.
- [R5] The length of the IPVC Identifier **MUST** be less than or equal to 53 characters.
- [R6] The value of the IPVC Identifier **MUST** be unique among all such identifiers for IPVCs supported by the Service Provider or Operator.

### 10.2 IPVC Topology Service Attribute

The IPVC Topology Service Attribute takes one of three possible values: *Multipoint*, *Rooted Multipoint* and *Cloud Access*. A multipoint IPVC allows packets to flow between any of the IPVC EPs for the IPVC – in this case, every IPVC EP has root role. The IPVC EP Role is further described in section 11.4. If a multipoint IPVC has only two IPVC EPs, it can be thought of as a point-to-point service. A rooted multipoint service is used to implement a hub-and-spoke topology. In a rooted multipoint service, each IPVC EP is assigned either root or leaf role. The rooted multipoint IPVC prevents packets flowing directly between IPVC EPs that have leaf role, but allows them to flow between roots and leaves or between roots. A cloud access IPVC allows traffic to flow between one or more IPVC EPs and the public Internet or a private cloud service. Cloud access IPVCs are described further in section 10.12.

An IPVC with the IPVC Topology set to *Multipoint* is known as a multipoint IPVC.

An IPVC with the IPVC Topology set to *Rooted Multipoint* is known as a rooted multipoint IPVC.

An IPVC with the IPVC Topology set to *Cloud Access* is known as a cloud access IPVC.

- [R7] For an Operator IP Service, the IPVC Topology Service Attribute **MUST NOT** be *Cloud Access*.

### 10.3 IPVC End Point List Service Attribute

The IPVC End Point List Service Attribute is a list of IPVC EP Identifiers (section 11.1) for the IPVC EPs that are connected by the IPVC.

A given IPVC can only have one IPVC EP at a given UNI or ENNI; however, it is still possible for IP Data Packets received at a given UNI to be transmitted out of the same UNI (see section 10.4). Similarly, it is possible for IP Data Packets received at a given ENNI over an ENNI Link with a given ENNI Service Mapping Context to be transmitted out of the same ENNI over an ENNI Link with the same ENNI Service Mapping Context (see section 10.4).

**[R8]** An IPVC **MUST NOT** have more than one IPVC EP at a given UNI.

**[R9]** An IPVC **MUST NOT** have more than one IPVC EP at a given ENNI.

Note that [R8] and [R9] do not preclude an IPVC having IPVC EPs at multiple different UNIs or multiple different ENNIs.

**[R10]** An IPVC for an Operator IP Service **MUST** have at least one IPVC EP at an ENNI.

**[R11]** An Ingress IP Data Packet that is not mapped to any IPVC EP **MUST NOT** result in a corresponding Egress IP Data Packet at any EI.

**[R12]** If an Egress IP Data Packet transmitted at an EI via a given IPVC EP results from an Ingress IP Data Packet received at a different EI (and therefore mapped to a different IPVC EP), the two IPVC EPs **MUST** be for the same IPVC.

**[R13]** At an ENNI where the ENNI Type Service Attribute (section 14.2) is *Option A*, an Egress IP Data Packet transmitted via a given IPVC EP over an ENNI Link that has been assigned a given ENNI Service Mapping Context via the ENNI Service Map Common Attribute (section 15.6) **MUST NOT** result from an Ingress IP Data Packet received at that ENNI over an ENNI Link that has been assigned a different ENNI Service Mapping Context.

**[R14]** If an Ingress IP Data Packet mapped to an IPVC EP is transmitted as an IP Packet towards a cloud service, there **MUST** be an IPVC with IPVC Topology set to *Cloud Access* that connects the IPVC EP to the cloud service.

**[R15]** If an IP Packet received from a cloud service is transmitted as an Egress IP Data Packet mapped to an IPVC EP, there **MUST** be an IPVC with IPVC Topology set to *Cloud Access* that connects the IPVC EP to the cloud service.

## 10.4 IPVC Packet Delivery Service Attribute

The primary purpose of an IPVC is to deliver IP Data Packets from an ingress EI to an egress EI, or between a UNI and a cloud service. The IPVC Packet Delivery Service Attribute specifies how the SP or Operator determines the egress UNI (and UNI Access Link) or egress ENNI (and ENNI Link) for each Ingress IP Data Packet that is mapped to one of the IPVC EPs for the IPVC. It takes one of the two values *Standard Routing*, or *Policy-Based Routing*. In the case of *Policy-Based Routing* some additional details of the policy are also specified.

Note: the behavior and requirements when the IPVC Packet Delivery Service Attribute is set to *Policy-Based Routing* are deferred to a future revision of this specification. Similarly, the behavior and requirements for delivering multicast IP Data Packets are deferred to a future revision of this specification.

If the IPVC Packet Delivery is *Standard Routing*, the egress UNI and UNI Access Link or egress ENNI and ENNI Link are generally selected by examining the destination IP address in the packet and matching it to an IP Prefix reachable via the IPVC EP at the egress EI – in other words, by normal IP routing. In some cases, other fields in the IP Packet can also be used, for example for ECMP. This is described in section 9.

- [R16]** When the IPVC Packet Delivery Service Attribute is set to *Standard Routing*, if a unicast Ingress IP Data Packet is mapped to an IPVC EP for the IPVC, the SP or Operator **MUST** select, for delivery of the packet, an egress UNI Access Link, egress ENNI Link, or, in a cloud access IPVC, the cloud service, as described in section 9.3.2.

The requirement above applies when a unicast Ingress IP Data Packet is mapped to an IPVC EP for the IPVC. The mechanism by which this is done is described in section 11.5.1.

- [R17]** When the IPVC Packet Delivery Service Attribute is set to *Standard Routing*, if a unicast IP Data Packet is received from a cloud service and is mapped to the IPVC, the SP **MUST** select, for delivery of the packet, an egress UNI Access Link as described in section 9.3.2.

How an IP Packet received from a cloud service is mapped to the correct cloud access IPVC is outside the scope of this document.

Note that, as described in section 9.3.2, if there is more than one possible egress UNI Access Link or ENNI Link for an IP Packet, the SP or Operator chooses the best one to use. Typically, this is done based on routing protocol cost/metric data, including that received from the Subscriber if a dynamic routing protocol is in use at the UNIs (see section 12.7). The SP or Operator might also choose to use Equal Cost Multipath or Unequal Cost Multipath to select an egress UNI Access Link or ENNI Link, although in this case care is needed to ensure no issues arise due to the potential for re-ordering of packets within a flow.

- [D1]** IP Packets mapped to an IPVC EP and belonging to the same packet flow **SHOULD** be delivered in the same order that they were received.

A packet flow in this context is identified by fields in the IP Packet header, including the Source Address, Destination Address, Protocol, and any applicable fields in the L4 header; for example, for IP Packets carrying TCP or UDP datagrams, this includes the source port number and destination port number.

The description in section 9 means that if standard routing is used in the IPVC, adhering to [R16] and [R17] automatically ensures compliance with [R12], [R13], [R14] and [R15] – that is, the packet is either delivered to an egress UNI Access Link in a UNI that is attached to the IPVC, to an egress ENNI Link in an ENNI that is attached to the IPVC, or to a cloud service for the IPVC

if it is a cloud access IPVC. Note that this does not preclude a UNI Access Link in the ingress UNI from being selected as the egress UNI Access Link.

## 10.5 IPVC Maximum Number of IPv4 Routes Service Attribute

The IPVC Maximum Number of IPv4 Routes Service Attribute limits the total number of IPv4 Prefixes that can be associated with IPVC EPs for the IPVC. It is an integer  $\geq 0$  or the special value *Unlimited*. With reference to the description in section 9, it is a limit on the number of unique IPv4 Prefixes contained in  $RID_L$  or  $RID_{LL}$  across all the IPVC EPs in the IPVC; or equivalently, a limit on the number of unique IPv4 Prefixes contained in  $RT_{IPVCEP}$  at a single IPVC EP with Root role.

- [D2] If the IPVC Maximum Number of IPv4 Routes Service Attribute is not *Unlimited*, the SP or Operator **SHOULD** disregard any IPv4 Prefixes associated with IPVC EPs for the IPVC above the limit specified by the IPVC Maximum Number of IPv4 Routes Service Attribute.
- [D3] When the limit specified by the IPVC Maximum Number of IPv4 Routes Service Attribute is reached or exceeded, the SP or Operator **SHOULD** select IPv4 Prefixes to disregard so as to minimize disruption to the service.

[D2] means that if the Subscriber advertises too many routes to the SP, the SP can disregard some of them. Similarly, if the Subscriber or another Operator advertises too many routes to an Operator, the Operator can disregard some of them. In both cases this can lead to blackholing of some of the Subscriber's traffic, or other undesirable behavior. The SP or Operator can minimize disruption by disregarding the most recently received IPv4 Prefixes so as to maintain the paths that were previously working.

If the IPVC Maximum Number of IPv4 Routes Service Attribute is set to 0, the effect is to disable IPv4 routing for the service, i.e. to create a service that is IPv6-only, or that uses policy-based routing (PBR, see section 10.4) to direct traffic between IPVC EPs. Note that PBR is not precluded when the value is greater than 0.

Note that the IPVC Maximum Number of IPv4 Routes Service Attribute limits the total number of IPv4 routes in the IPVC. This document also specifies a limit per IPVC EP – see section 11.7.

It can be useful for the SP to notify the Subscriber when the total number of IPv4 Prefixes that are associated with IPVC EPs for the IPVC is approaching the limit specified by the IPVC Maximum Number of IPv4 Routes Service Attribute, or has crossed it. Likewise it is useful for an Operator to notify the SP/SO that is using their service. The details of how this is done are outside the scope of this document.

- [D4] For a Subscriber IP Service, the SP **SHOULD** notify the Subscriber when the total number of IPv4 Prefixes that are associated with IPVC EPs for the IPVC reaches the value of the IPVC Maximum Number of IPv4 Routes Service Attribute.

- [O3] For a Subscriber IP Service, the SP **MAY** notify the Subscriber when the total number of IPv4 Prefixes that are associated with IPVC EPs for the IPVC is approaching the value of the IPVC Maximum Number of IPv4 Routes Service Attribute.
- [D5] For an Operator IP Service, the Operator **SHOULD** notify the SP/SO when the total number of IPv4 Prefixes that are associated with IPVC EPs for the IPVC reaches the value of the IPVC Maximum Number of IPv4 Routes Service Attribute.
- [O4] For an Operator IP Service, the Operator **MAY** notify the SP/SO when the total number of IPv4 Prefixes that are associated with IPVC EPs for the IPVC is approaching the value of the IPVC Maximum Number of IPv4 Routes Service Attribute.

If an Operator IP Service with IPv4 enabled has an IPVC EP at an ENNI using Option A, the corresponding ENNI Links need to have IPv4 addresses assigned in order to be able to carry routes for the service.

- [R18] For an Operator IP Service, if the IPVC Maximum Number of IPv4 Routes Service Attribute is not 0, then for any IPVC EPs in that IPVC that are at an ENNI with the ENNI Type Service Attribute (section 14.2) set to *Option A*, the ENNI Links assigned (via the ENNI Service Map Common Attribute, section 15.6) to the ENNI Service Mapping Context corresponding to the IPVC EP ENNI Service Mapping Identifier (section 11.6) for that IPVC EP **MUST NOT** have ENNI Link IPv4 Connection Addressing Attribute (section 16.3) set to *None*.

## 10.6 IPVC Maximum Number of IPv6 Routes Service Attribute

The IPVC Maximum Number of IPv6 Routes Service Attribute limits the total number of IPv6 Prefixes that can be associated with IPVC EPs for the IPVC. It is an integer  $\geq 0$  or the special value *Unlimited*. With reference to the description in section 9, it is a limit on the number of unique IPv6 Prefixes contained in  $RID_L$  or  $RID_{LL}$  across all the IPVC EPs in the IPVC; or equivalently, a limit on the number of unique IPv6 Prefixes contained in  $RT_{IPVCEP}$  at a single IPVC EP with Root role.

- [D6] If the IPVC Maximum Number of IPv6 Routes Service Attribute is not *Unlimited*, the SP or Operator **SHOULD** disregard any IPv6 Prefixes associated with IPVC EPs for the IPVC above the limit specified by the IPVC Maximum Number of IPv6 Routes Service Attribute.
- [D7] When the limit specified by the IPVC Maximum Number of IPv6 Routes Service Attribute is reached or exceeded, the SP **SHOULD** select IPv6 Prefixes to disregard so as to minimize disruption to the service.

[D6] means that if the Subscriber advertises too many routes to the SP, the SP can disregard some of them. Similarly, if the Subscriber or another Operator advertises too many routes to an Operator, the Operator can disregard some of them. In both cases this can lead to blackholing of some of the Subscriber's traffic, or other undesirable behavior. The SP or Operator can minimize disruption by disregarding the most recently received IPv6 Prefixes so as to maintain the paths that were previously working.

If the IPVC Maximum Number of IPv6 Routes Service Attribute is set to 0, the effect is to disable IPv6 routing for the service, i.e. to create a service that is IPv4-only, or that uses policy-based routing (PBR, see section 10.4) to direct traffic between IPVC EPs. Note that PBR is not precluded when the value is greater than 0.

Note that the IPVC Maximum Number of IPv6 Routes Service Attribute limits the total number of IPv6 routes in the IPVC. This document also specifies a limit per IPVC EP – see section 11.8.

It can be useful for the SP to notify the Subscriber when the total number of IPv6 Prefixes that are associated with IPVC EPs for the IPVC is approaching the limit specified by the IPVC Maximum Number of IPv6 Routes Service Attribute, or has crossed it. Likewise it is useful for an Operator to notify the SP/SO that is using their service. The details of how this is done are outside the scope of this document.

- [D8] For a Subscriber IP Service, the SP **SHOULD** notify the Subscriber when the total number of IPv6 Prefixes that are associated with IPVC EPs for the IPVC reaches the value of the IPVC Maximum Number of IPv6 Routes Service Attribute.
- [O5] For a Subscriber IP Service, the SP **MAY** notify the Subscriber when the total number of IPv6 Prefixes that are associated with IPVC EPs for the IPVC is approaching the value of the IPVC Maximum Number of IPv6 Routes Service Attribute.
- [D9] For an Operator IP Service, the Operator **SHOULD** notify the SP/SO when the total number of IPv6 Prefixes that are associated with IPVC EPs for the IPVC reaches the value of the IPVC Maximum Number of IPv6 Routes Service Attribute.
- [O6] For an Operator IP Service, the Operator **MAY** notify the SP/SO when the total number of IPv6 Prefixes that are associated with IPVC EPs for the IPVC is approaching the value of the IPVC Maximum Number of IPv6 Routes Service Attribute.

If an Operator IP Service with IPv6 enabled has an IPVC EP at an ENNI using Option A, the corresponding ENNI Links need to have IPv6 addresses assigned in order to be able to carry routes for the service.

- [R19] For an Operator IP Service, if the IPVC Maximum Number of IPv6 Routes Service Attribute is not 0, then for any IPVC EPs in that IPVC that are at an ENNI with the ENNI Type Service Attribute (section 14.2) set to *Option A*, the

ENNI Links assigned (via the ENNI Service Map Common Attribute, section 15.6) to the ENNI Service Mapping Context corresponding to the IPVC EP ENNI Service Mapping Identifier (section 11.6) for that IPVC EP **MUST NOT** have ENNI Link IPv6 Connection Addressing Attribute (section 16.4) set to *None*.

## 10.7 IPVC DSCP Preservation Service Attribute

The IPVC DSCP Preservation Service Attribute specifies whether the SP or Operator is allowed to modify the value of the DS field (see RFC 3260 [22]) in Ingress IP Data Packets. It takes one of two values: *Enabled* or *Disabled*. Preserving the value of the DSCP field can be useful if the Subscriber uses the DS field for their own purposes and does not want the SP to modify it. This does not prevent the SP or an Operator from mapping ingress IP Data Packets to different Classes of Service, and/or marking the packets in some other way as they traverse the SP or Operator Network (for example, using the MPLS TC bits, if the SP implements the IPVC using MPLS).

**[R20]** If the value of the IPVC DSCP Preservation Service Attribute is *Enabled*, the value of the DS Field in an Egress IP Data Packet **MUST** be identical to the value of the DS Field in the corresponding Ingress IP Data Packet.

Note that the 3 most significant bits of the DS Field correspond to the (historic) IP Precedence field.

If the value of the IPVC DSCP Preservation Service Attribute is *Disabled*, the SP or Operator is not required to preserve the value of the DS Field received in an Ingress IP Packets when transmitting the corresponding Egress IP Packet. However, they may be required to set the DS Field according to the IPVC EP Egress Class of Service Map (section 11.10).

## 10.8 IPVC List of Class of Service Names Service Attribute

The IPVC List of Class of Service Names Service Attribute is a list of CoS Names (also known as “Traffic Classes”) used in the IPVC. A CoS Name is an arbitrary string, and represents the end-to-end behavior across the IPVC for traffic mapped to the CoS Name (see section 11.9), as specified through the use of per-CoS Name Bandwidth Profile Flows (see section 17.2) and per-CoS Name SLS Performance Objectives (see section 10.9).

Note that there are a set of standard DSCP names registered with IANA [62], which can be (but do not have to be) used as CoS Names for an IPVC: *CS0, CS1, CS2, CS3, CS4, CS5, CS6, CS7, AF11, AF12, AF13, AF21, AF22, AF23, AF31, AF32, AF33, AF41, AF42, AF43, EF, VOICE-ADMIT*. These standard names above can refer to two different concepts:

- The name for a particular Differentiated Services Code Point, i.e. a particular value of the DS Field in IP Packets.
- The name for a particular “per-hop behavior” (PHB). As described in RFC 2474 [14] and RFC 2475 [15], DSCP values are mapped to a PHB at each node that forwards the packet, and it is recommended that each DSCP value is mapped to the corresponding PHB. PHBs are composed as the packet is forwarded over the network so as to give the desired end-to-end behavior.



An exception to the above is that the set of “class selector” names (*CS0* to *CS7*) cannot refer to a PHB – there are no specific PHBs defined with these names, although RFC 2474 [14] places some requirements on the PHBs that the corresponding DSCP values map to.

Since CoS Names are arbitrary, the standard DSCP names can also be used as CoS Names (for example, a CoS Name ‘*EF*’ could be defined). However, this does not imply that any particular DSCP values are used (either at the UNI or ENNI or within the SP or Operator Network), or that any particular PHB is applied within the SP or Operator Network. To avoid confusion, Subscribers, SPs and Operators may wish to avoid using the standard DSCP names as CoS Names.

**[R21]** In the context of Differentiated Services, the end-to-end behavior across an IPVC **MUST** be the same as if a Differentiated Services Domain as specified in RFC 2474 [14] corresponds to the IPVC.

Note that, as described in RFC 2475 [15], traffic is mapped to a CoS Name on ingress to the DS Domain; that is, at the ingress EI. This mapping is specified in the IPVC EP Ingress Class of Service Map Service Attribute (section 11.9). The RFCs recommend that within the DS Domain, such traffic is marked with the corresponding DSCP value as specified by IANA [62]; however, other than as required by the IPVC DSCP Preservation Service Attribute (section 10.7), the use of specific DSCP values within the SP or Operator Network is outside the scope of this document.

## 10.9 IPVC Service Level Specification Service Attribute

The IPVC Service Level Specification (SLS) describes the performance objectives for the performance of conformant IP Data Packets that flow over the IPVC – in other words, of IP Data Packets that are Qualified Packets (see 10.9.2). For example, objectives might be specified for packet loss or packet delay (latency). The performance objectives specified in the SLS often form part of a Service Level Agreement (SLA), which can also specify penalties for the SP or Operator providing the service if the objectives are not met, along with other details such as the service bringup time or the time to respond to customer queries. Such details are beyond the scope of this document.

The IPVC Service Level Specification Service Attribute is either *None*, or a four-tuple of the form (*s*, *T*, *E*, *L*) where *s* is the start time, *T* is a period of time, *E* is a set of SLS entries, and *L* is a set of locations as described in section 10.9.1. Each SLS entry in *E* contains the Performance Metric, the CoS Name, and number of other parameters specific to the Performance Metric, as described in the subsections below.

Some examples showing the structure and value of the IPVC Service Level Specification Service Attribute can be found in Appendix B.6.

The IPVC SLS allows objectives to be specified for a number of Performance Metrics. These Performance Metrics describe the performance experienced by the Subscriber or by the SP/SO using the service. The methods used (by the SP, an Operator or the Subscriber) to measure the IPVC performance are beyond the scope of this document.

Each performance objective is specific to a given CoS Name. Multiple objectives can be specified for the same Performance Metric, e.g. for different CoS Names or between different sets of IPVC EPs. Note that this is only useful if at least one of the parameters is different.

This document specifies the following Performance Metrics that can be used in an SLS Entry:

- One-way Packet Delay Percentile (section 10.9.4).
- One-way Mean Packet Delay (section 10.9.5).
- One-way Inter-Packet Delay Variation (section 10.9.6).
- One-way Packet Delay Range (section 10.9.7).
- One-way Packet Loss Ratio (section 10.9.8).
- Service Uptime (section 10.9.9).

Other Performance Metrics can also be used in the SLS, subject to agreement between the Subscriber and the SP (for a Subscriber IP Service) or between the SP/SO and the Operator (for an Operator IP Service).

The SLS performance objectives are evaluated over a series of consecutive time periods. These time periods are specified by the parameters  $s$  and  $T$  in the value of the IPVC SLS Service Attribute. One time period, denoted  $T_0$ , starts at time  $s$  and has duration  $T$ . Each subsequent time period, denoted  $T_k$ , starts at time  $s + kT$  where  $k$  is an integer, and has duration  $T$ ; in other words, each new time period starts as soon as the previous one ends. Each Performance Metric is evaluated for each time period  $T_k$ , so one can say that for a given  $T_k$ , the performance objective is either met or not met.

Note that  $T$  can be specified using any time units; in particular, calendar months are allowable. In this case, if  $s$  is specified as, for example, midnight on the 5<sup>th</sup> of January and  $T$  is 1 calendar month, then each subsequent  $T_k$  will start at midnight on the 5<sup>th</sup> of the month.

The third parameter of the IPVC SLS Service Attribute is a set,  $E$ , of SLS entries. Each entry consists of the Performance Metric, the CoS Name, and number of other parameters specific to the Performance Metric, as described in the subsections below.

**[R22]** The CoS Name specified in an SLS Entry **MUST** be one of the CoS Names specified in the IPVC List of Class of Service Names (section 10.8).

Performance objectives can be specified between a number of different network locations, as described in section 10.9.1 below. Most performance objectives apply to Qualified Packets, as described in section 10.9.2 below.

Note: ITU-T Recommendation Y.1540 [71] defines parameters that can be used in specifying and assessing the performance of speed, accuracy, dependability and availability of IP Packet transfer of Internet Protocol (IP) data communication services. The defined parameters apply to an end-to-end, point-to-point IP Service. These are similar in intent to the Performance Metrics defined in this specification. In addition ITU-T Recommendation Y.1541 [72] specifies network (UNI to UNI) IP performance objectives for each of the performance parameters defined in ITU-T Y.1540 [71]. The specific performance objectives vary, depending on the network QoS class. The network QoS classes defined are intended to be the basis of agreements between end-users and network Service Providers, and between Service Providers. Definition of specific values for performance objectives is outside the scope of this document.

### 10.9.1 SLS Reference Points

In a multipoint or rooted multipoint IPVC, performance objectives are ideally specified as applying between pairs of IPVC EPs – in other words, they apply to the performance that IP Data Packets experience as they flow from one EI to another. However, in many cases there are practical difficulties in measuring performance between EIs – and in particular between UNIs – so as to determine whether the objective has been met, for example due to limitations in the equipment used or because of the number of UNIs to which an IPVC is attached. It might also be difficult to determine exactly where the EI is located, for example in the case where a UNI Access Link is an IPsec tunnel over the public Internet.

In a cloud access IPVC, as well as specifying performance objectives between UNIs, it can be desirable to specify performance objectives for traffic flowing to or from the cloud service.

In all these cases, the performance objectives can be specified as applying between pairs of locations rather than pairs of IPVC EPs, where each location is associated with one or more IPVC EPs or with a cloud service. A location can refer to a specific address (such as the SP's premises where the PE is located), a city, a region, or even a country.

Note that IPVC EPs located at an ENNI cannot be associated with a location, as the devices used to implement ENNIs typically have higher control plane capacity and/or more functionality, and the number of ENNIs typically lower, than for UNIs.

For ease of description, many of the Performance Metrics described in the sections below are defined between pairs of SLS Reference Points (SLS-RPs). An SLS-RP is defined to be one of:

- An IPVC EP for the IPVC.
- A location that is associated with one or more of the IPVC EPs for the IPVC, for IPVC EPs at UNIs.
- For a cloud access IPVC, a location that is associated with the corresponding cloud service.

If the SLS includes any entries where one or both of the SLS-RPs is a location, then the IPVC SLS Service Attribute includes a set  $L$  with one entry for each location, containing:

- Location Name.
- Description of the Location.
- List of IPVC EP Identifiers (see section 11.1) of IPVC EPs for the IPVC, that are associated with this location.
- For a cloud access IPVC, an indication of whether the corresponding cloud service (see section 10.13) is associated with this location.

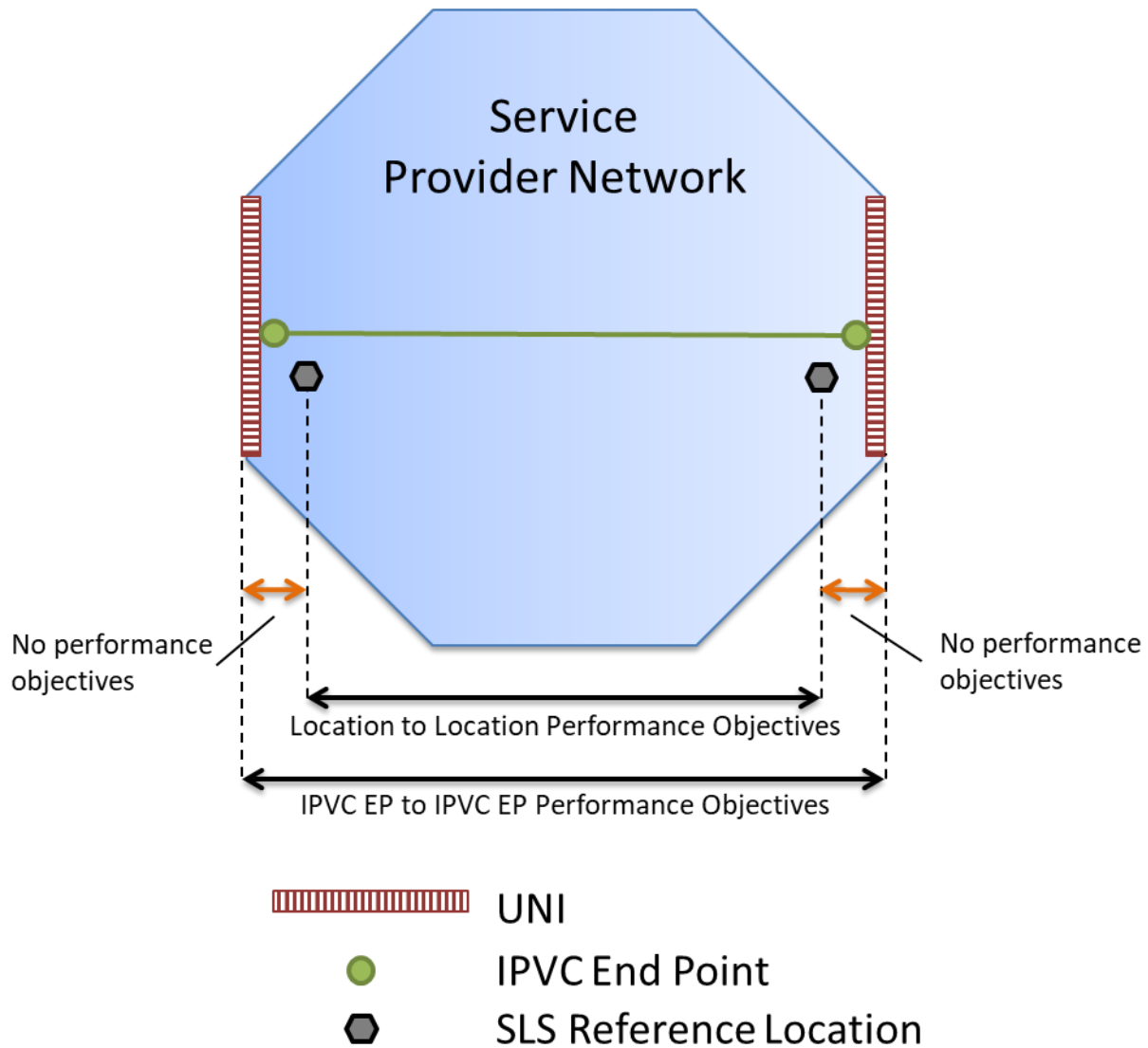
**[R23]** A given entry in  $L$  **MUST** either have a non-empty list of IPVC EP Identifiers, or for a cloud access service, indicate that the cloud service is associated with this location.

**[R24]** A given IPVC EP **MUST** appear in at most one entry in set  $L$ .

**[R25]** An IPVC EP listed in an entry in set *L* **MUST** be located at a UNI.

If all of the SLS-RPs used in the SLS entries are IPVC EPs, then the set *L* can be empty.

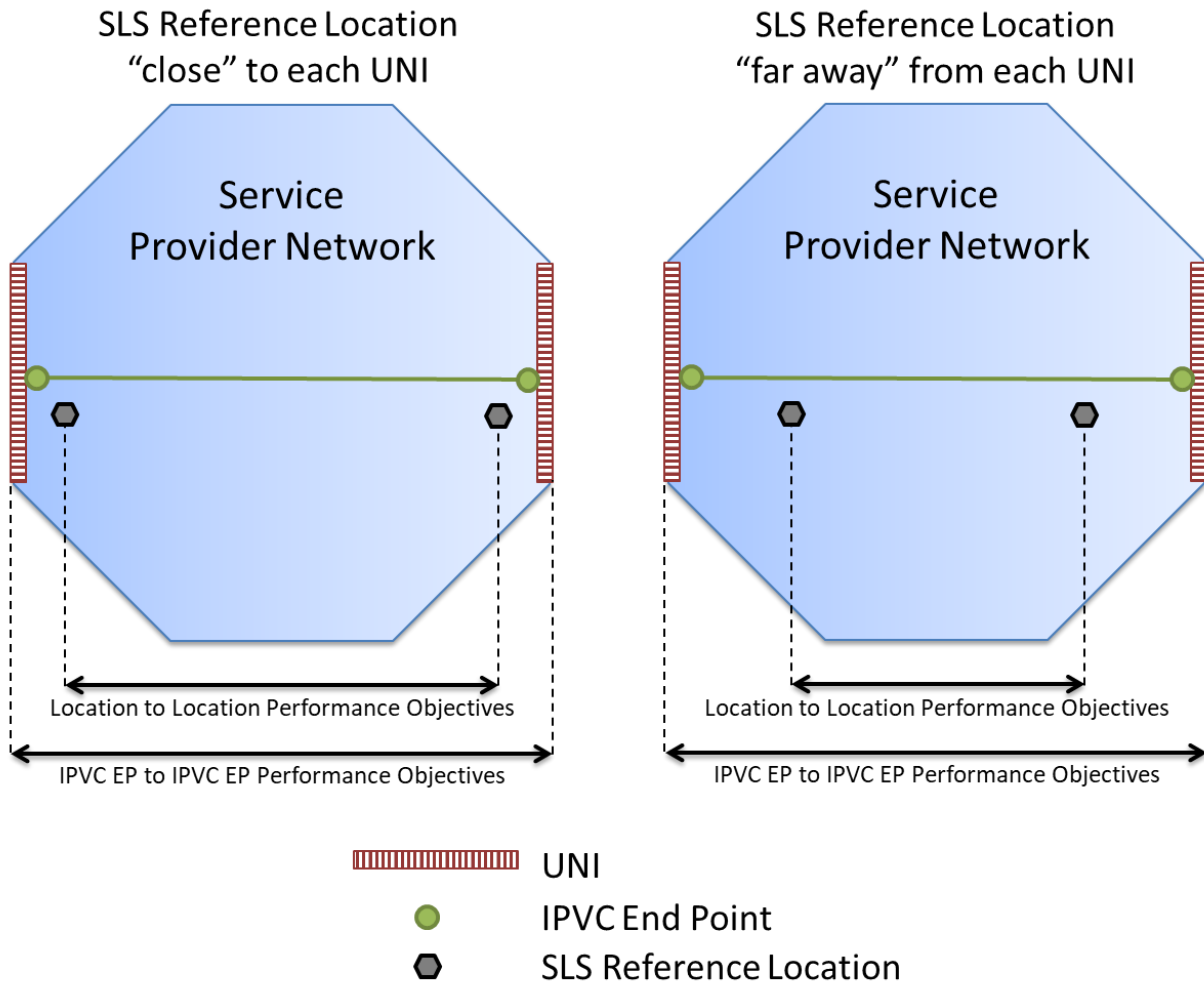
An SLS performance objective that is specified between locations applies to the performance between reference points chosen by the SP or Operator in those locations; it gives no guarantees about the loss or delay experienced between the EI and the associated location reference point. This is illustrated in Figure 26.



**Figure 26 – Example of SLS specified using locations**

When agreeing on an SLS using locations, the Subscriber and the SP (or the SP/SO and the Operator) need to consider the nature of the network between the EI for the IPVC EPs, and the reference point in the corresponding location, as illustrated in Figure 27. If the EI is “close” to the reference point – for example, in the case of a Subscriber-Managed CE where the UNI consists of a short dedicated fiber connection between the CE and the PE, and the PE is the reference point in the

location – the difference between the EI to EI performance and the location to location performance might be negligible. Conversely, if the EI is “far away” from the reference point – for example in the case of a Provider-Managed CE where the UNI is on the Subscriber side of the CE, and the CE is connected to the reference point across an intervening Ethernet access network, which could span across an entire continent – the difference might be highly significant. Note that the EI might not be “connected” to the reference point in its location at all, for instance if the reference point is a different PE to the one the UNI is connected to, but in the same city.



**Figure 27 – Impact of SLS reference locations**

There are two factors that can mitigate the difference between the EI to EI performance and the location to location performance:

- If SP and the Subscriber (or the SP/SO and the Operator) agree to associate each EI with a location that is physically close to it (for instance, in the same city as the EI), and each cloud service with locations that are physically close to where the SP is connected to the cloud service, then the location to location performance will more closely match the EI to EI performance.

- Further performance objectives can be defined that apply between an IPVC EP at an EI and its associated location. By combining these objectives with the location to location objectives, the overall EI to EI performance can be approximated.

Many of the Performance Metrics described in the sections below are based on a set  $S$  of ordered pairs of SLS-RPs. In such cases, the following requirement applies:

**[R26]** If an ordered pair of SLS-RPs is specified as part of a set  $S$ , they **MUST NOT** both be IPVC EPs with the IPVC EP Role (section 11.4) equal to *Leaf*.

[R26] prevents a case where both of the SLS-RPs in a pair are leaves – this is not useful since no traffic can flow between leaves. All other cases are allowed, i.e. where one of the SLS-RPs is a leaf IPVC EP and the other is a root IPVC EP or a location, or where both SLS-RPs in a pair are root IPVC EPs or locations. In particular, [R26] does not preclude a case where both SLS-RPs in a pair are locations that only have leaf IPVC EPs associated with them, although this case is also not useful.

IP Services are generally bidirectional, and so it is recommended that both orders of a given pair of SLS-RPs are included in set  $S$ .

**[D10]** If an ordered pair of SLS-RPs  $\langle i, j \rangle$  is specified as part of a set  $S$ , an ordered pair containing the same SLS-RPs in the opposite order, i.e.  $\langle j, i \rangle$ , **SHOULD** also be included in set  $S$ .

Note that in a cloud access IPVC, the cloud service might be associated with multiple locations. This means that even if there is only one IPVC EP at a UNI in the service, there could be more than two possible ordered pairs of SLS-RPs.

Some examples showing the structure and value of the IPVC Service Level Specification Service Attribute, including locations, can be found in Appendix B.6.

### 10.9.2 Qualified Packets

Many of the Performance Metrics specified in the sections below apply to Qualified Packets. A Qualified Packet is any unicast IP Data Packet that satisfies the following criteria for a given period  $T_k$ , a given CoS Name  $C$ , and a given pair of SLS-RPs  $\langle i, j \rangle$  contained in  $S$ :

- The IP Data Packet ingresses at an EI associated with SLS-RP  $i$ . That is:
  - If  $i$  is an IPVC EP, then the IP Data Packet ingress at the EI where the IPVC EP is located.
  - If  $i$  is a location, then the IP Data Packet ingresses at a UNI that has an IPVC EP that is associated with that location as specified in set  $L$ , or is received from a cloud service associated with that location as specified in set  $L$ .
- The IP Data Packet is mapped to this IPVC as described in section 11.5.1, and to CoS Name  $C$  as described in section 11.9 or 10.13.2.
- The IP Data Packet should be delivered to the EI associated with SLS-RP  $j$ , per the packet delivery requirements of section 10.4. That is:

- If  $j$  is an IPVC EP, then the IP Data Packet should be delivered to the EI where the IPVC EP is located.
- If  $j$  is a location, then the IP Data Packet should be delivered to a UNI that has an IPVC EP that is associated with that location as specified in set  $L$ , or to a cloud service associated with that location as specified in set  $L$ .
- The IP Data Packet is not discarded per requirements [O2], [O7], [R47], [R51], [O8], [O9], [O10], [O11], [R73], [R77], [R87], [R123] or [R252], or to comply with the requirements of RFC 791 [1] or RFC 8200 [57].
- The IP Data Packet is not discarded as a result of another agreement between the SP and the Subscriber (for a Subscriber IP Service) or between the SP/SO and the Operator (for an Operator IP Service), for example as part of a value-added over the top service offering.
- The length of the IP Data Packet is less than or equal to the value of the IPVC MTU Service Attribute (section 10.10).
- The first bit of the Ingress IP Data Packet arrives at the EI associated with SLS-RP  $i$ , or was received from the cloud service associated with SLS-RP  $i$ , within time interval  $T_k$ .

The definition above ensures that IP Packets that are discarded for any of the following reasons are not Qualified Packets; hence, they do not contribute to the Packet Loss Ratio (section 10.9.8) or other performance objectives specified in the SLS:

- IPv4 Packets with the Source Route or Record Route options.
- IP Packets larger than the IPVC MTU (section 10.10).
- IP Packets flowing between Leaf IPVC EPs, in a rooted multipoint IPVC or a cloud access IPVC.
- IP Packets mapped to CoS Name *Discard*.
- IP Packets discarded due to an ingress or egress Bandwidth Profile (section 17.4).
- IP Packets in excess of the Cloud Data Limit in a cloud access IPVC (section 10.13.3).

### 10.9.3 One-way Packet Delay

The one-way packet delay for an IP Data Packet that flows between SLS-RP  $i$  and SLS-RP  $j$  is defined as the time elapsed from the reception of the first bit of the packet at SLS-RP  $i$  until the transmission of the last bit of the first corresponding egress packet at SLS-RP  $j$ . If the packet is erroneously duplicated as it traverses the network, the delay is based on the first copy that is delivered.

Note: If the SLS-RPs are locations, they should be chosen such that sufficient data packets traverse them that a representative view of the performance of the service can be gained.

If the IP Data Packet incurs additional delay as a result of another agreement between the SP and the Subscriber (or between the SP/SO and the Operator), this additional delay is not included in the one-way packet delay for the IP Service. Such additional delay might result, for example, from the application of a value-added service to the IP Data Packet.

Note that this definition of One-way Packet Delay for a packet includes the delays encountered as a result of transmission across the ingress and egress SLS-RPs as well as that introduced by the network that connects them.

One-way packet delay is used in the definition of several Performance Metrics as defined below.

#### 10.9.4 One-way Packet Delay Percentile Performance Metric

The One-way Packet Delay Percentile Performance Metric is the maximum, over all the ordered pairs of SLS-RPs in a given set  $S$ , of the  $p^{th}$  percentile of one-way packet delay for Qualified Packets for a given ordered pair of SLS-RPs, a given CoS Name, and a given time period  $T_k$ .

Table 4 lists the contents of an SLS entry for the One-way Packet Delay Percentile Performance Metric.

Item	Description	Values
Performance Metric	Name of the Performance Metric	One-way Packet Delay Percentile.
$C$	CoS Name	One of the values in the IPVC List of Class of Service Names Service Attribute (section 10.8).
$S$	Set of ordered SLS-RP pairs	A set of ordered SLS-RP pairs as defined in section 10.9.1.
$p$	Packet Delay Percentile	A real number between 0 and 100.
$\hat{d}$	Packet Delay Objective	A real number $>0$ in time units.

**Table 4 – Parameters for One-way Packet Delay Percentile**

[R27] If the SLS contains an entry for the One-way Packet Delay Percentile Performance Metric, it **MUST** be defined as follows, for a given set of parameters as defined in Table 4 and a given time period  $T_k$ :

- Let  $\delta(T_k, C, \langle i, j \rangle, p)$  represent the  $p^{th}$  percentile of one-way packet delay for all Qualified Packets for time period  $T_k$ , CoS Name  $C$  and ordered pair of SLS-RPs  $\langle i, j \rangle$  in  $S$  that are delivered to SLS-RP  $j$ . If there are no such packets, let  $\delta(T_k, C, \langle i, j \rangle, p)$  equal 0.
- Then the One-way Packet Delay Percentile Performance Metric  $d(T_k, C, S, p)$  is the maximum of the values  $\delta(T_k, C, \langle i, j \rangle, p)$  for all  $\langle i, j \rangle$  in  $S$ .

[R28] If the SLS contains an entry for the One-way Packet Delay Percentile Performance Metric, it **MUST** define the objective as being met over time period  $T_k$  for an SLS entry of the form specified in Table 4 if and only if  $d(T_k, C, S, p) \leq \hat{d}$ .



### 10.9.5 One-way Mean Packet Delay Performance Metric

The One-way Mean Packet Delay Performance Metric is the maximum, over all the ordered pairs of SLS-RPs in a given set  $S$ , of the arithmetic mean of one-way packet delay for Qualified Packets for a given ordered pair of SLS-RPs, a given CoS Name, and a given time period  $T_k$ .

Table 5 lists the contents of an SLS entry for the One-way Mean Packet Delay Performance Metric.

Item	Description	Values
Performance Metric	Name of the Performance Metric	One-way Mean Packet Delay.
$C$	CoS Name	One of the values in the IPVC List of Class of Service Names Service Attribute (section 10.8).
$S$	Set of ordered SLS-RP pairs	A set of ordered SLS-RP pairs as defined in section 10.9.1.
$\hat{u}$	Mean Packet Delay Objective	A real number $>0$ in time units.

**Table 5 – Parameters for One-way Mean Packet Delay**

**[R29]** If the SLS contains an entry for the One-way Mean Packet Delay Performance Metric, it **MUST** be defined as follows, for a given set of parameters as defined in Table 5 and a given time period  $T_k$ :

- Let  $\mu(T_k, C, \langle i, j \rangle)$  represent the arithmetic mean of one-way packet delay for all Qualified Packets for time period  $T_k$ , CoS Name  $C$  and ordered pair of SLS-RPs  $\langle i, j \rangle$  in  $S$  that are delivered to SLS-RP  $j$ . If there are no such packets, let  $\mu(T_k, C, \langle i, j \rangle)$  equal 0.
- Then the One-way Mean Packet Delay Performance Metric  $u(T_k, C, S)$  is the maximum of the values  $\mu(T_k, C, \langle i, j \rangle)$  for all  $\langle i, j \rangle$  in  $S$ .

**[R30]** If the SLS contains an entry for the One-way Mean Packet Delay Performance Metric, it **MUST** define the objective as being met over time period  $T_k$  for an SLS entry of the form specified in Table 5 if and only if  $u(T_k, C, S) \leq \hat{u}$ .

### 10.9.6 One-way Inter-Packet Delay Variation Performance Metric

The One-way Inter-Packet Delay Variation Performance Metric is the maximum, over all the ordered pairs of SLS-RPs in a given set  $S$ , of the  $v^{th}$  percentile of differences between the one-way packet delays of Qualified Packets that arrive at times separated by a given interval  $\tau$ , for a given ordered pair of SLS-RPs, a given CoS Name, and a given time period  $T_k$ .

Table 6 lists the contents of an SLS entry for the One-way Inter-Packet Delay Variation Performance Metric.

Item	Description	Values
Performance Metric	Name of the Performance Metric	One-way Inter-Packet Delay Variation.
$C$	CoS Name	One of the values in the IPVC List of Class of Service Names Service Attribute (section 10.8).
$S$	Set of ordered SLS-RP pairs	A set of ordered SLS-RP pairs as defined in section 10.9.1.
$\tau$	Difference in the time of arrival of packets	A real number $>0$ in time units.
$\nu$	Inter-Packet Delay Variation Percentile	A real number between 0 and 100.
$\hat{w}$	Inter-Packet Delay Variation Objective	A real number $>0$ in time units.

**Table 6 – Parameters for One-way Inter-Packet Delay Variation**

**[R31]** If the SLS contains an entry for the One-way Inter-Packet Delay Variation Performance Metric, it **MUST** be defined as follows, for a given set of parameters as specified in Table 6 and a given time period  $T_k$ :

- Let  $a(P, Q, T_k, C, \langle i, j \rangle)$  be the absolute difference between the one-way packet delay of packet  $P$  and the one-way packet delay of packet  $Q$  where  $P$  and  $Q$  are Qualified Packets for time period  $T_k$ , CoS Name  $C$  and ordered pair of SLS-RPs  $\langle i, j \rangle$  in  $S$ ,  $P$  arrives at SLS-RP  $i$  before  $Q$ , and both  $P$  and  $Q$  are delivered to SLS-RP  $j$ .
- Let  $\omega(T_k, C, \langle i, j \rangle, \tau, \nu)$  represent the  $\nu^{\text{th}}$  percentile of the values of  $a(P, Q, T_k, C, \langle i, j \rangle)$  for all packets  $P$  and  $Q$  where the difference between the time packet  $P$  arrives at SLS-RP  $i$  and the time packet  $Q$  arrives at SLS-RP  $i$  is equal to  $\tau$  and both  $P$  and  $Q$  are delivered to SLS-RP  $j$ . If there are no such packets, let  $\omega(T_k, C, \langle i, j \rangle, \tau, \nu)$  equal 0.
- Then the One-way Inter-Packet Delay Variation Performance Metric  $w(T_k, C, S, \tau, \nu)$  is the maximum of all the values  $\omega(T_k, C, \langle i, j \rangle, \tau, \nu)$  for all  $\langle i, j \rangle$  in  $S$ .

The definition of IPDV can be thought of as being determined by selecting pairs of packets,  $P$  and  $Q$ , whose arrival time differs by  $\tau$ , and then calculating the absolute difference in their one-way packet delays. Note that if  $P$  takes longer than  $Q$ , the difference in one-way packet delay will be negative, whereas if  $P$  takes less time than  $Q$ , the difference will be positive. However, since the absolute value of the difference is used in the calculation, these cases are treated identically.

**[R32]** If the SLS contains an entry for the One-way Inter-Packet Delay Variation Performance Metric, it **MUST** define the objective as being met over time period  $T_k$  for an SLS entry of the form specified in Table 6 if and only if  $w(T_k, C, S, \tau, \nu) \leq \hat{w}$ .

Note: RFC 3393 [24] defines a metric for variation in delay of packets across Internet paths that has a similar purpose to the definition of IPDV and PDR in this specification. The metric is based on the difference in the One-Way-Delay of selected pairs of packets (over some period of time), and is valid for measurements between two hosts both in the case that they have synchronized clocks and in the case that they are not synchronized. However, the method of selecting pairs of packets is not specified. RFC 5481 [39] provides applicability statements for different metrics relating to Packet Delay Variation.

### 10.9.7 One-way Packet Delay Range Performance Metric

The One-way Packet Delay Range Performance Metric is the maximum, over all the ordered pairs of SLS-RPs in a given set  $S$ , of the difference between the  $r^{th}$  percentile of one-way packet delay and the minimum one-way packet delay, for Qualified Packets for a given ordered pair of SLS-RPs, a given CoS Name, and a given time period  $T_k$ .

Table 7 lists the contents of an SLS entry for the One-way Packet Delay Range Performance Metric.

Item	Description	Values
Performance Metric	Name of the Performance Metric	One-way Packet Delay Range.
$C$	CoS Name	One of the values in the IPVC List of Class of Service Names Service Attribute (section 10.8).
$S$	Set of ordered SLS-RP pairs	A set of ordered SLS-RP pairs as defined in section 10.9.1.
$r$	Packet Delay Range Percentile	A real number between 0 and 100.
$\hat{g}$	Packet Delay Range Objective	A real number $>0$ in time units.

**Table 7 – Parameters for One-way Packet Delay Range**

**[R33]** If the SLS contains an entry for the One-way Packet Delay Range Performance Metric, it **MUST** be defined as follows, for a given set of parameters as defined in Table 7 and a given time period  $T_k$ :

- Let  $\gamma(T_k, C, \langle i, j \rangle, r)$  represent the  $r^{th}$  percentile of one-way packet delay for all Qualified Packets for time period  $T_k$ , CoS Name  $C$  and ordered pair of SLS-RPs  $\langle i, j \rangle$  in  $S$  that are delivered to SLS-RP  $j$ . If there are no such packets, let  $\gamma(T_k, C, \langle i, j \rangle, r)$  equal 0.
- Let  $m(T_k, C, \langle i, j \rangle)$  represent the minimum one-way packet delay for all Qualified Packets for time period  $T_k$ , CoS Name  $C$  and ordered pair of SLS-RPs  $\langle i, j \rangle$  in  $S$  that are delivered to SLS-RP  $j$ . If there are no such packets, let  $m(T_k, C, \langle i, j \rangle)$  equal 0.
- Then the One-way Packet Delay Range Performance Metric  $g(T_k, C, S, r)$  is the maximum of the values  $\gamma(T_k, C, \langle i, j \rangle, r) - m(T_k, C, \langle i, j \rangle)$  for all  $\langle i, j \rangle$  in  $S$ .

**[R34]** If the SLS contains an entry for the One-way Packet Delay Range Performance Metric, it **MUST** define the objective as being met over time period  $T_k$  for an SLS entry of the form specified in Table 7 if and only if  $g(T_k, C, S, r) \leq \hat{g}$ .

As noted above RFC 3393 [24] defines a metric for variation in delay of packets across Internet paths that has a similar purpose to the definition of IPDV and PDR in this specification. ITU-T Y.1540 [71] also contains a similar definition (the metric is referred to as “PDV”).

### 10.9.8 One-way Packet Loss Ratio Performance Metric

The One-way Packet Loss Ratio Performance Metric is the maximum, over all the ordered pairs of SLS-RPs in a given set  $S$ , of the ratio of lost packets to transmitted packets for a given ordered pair of SLS-RPs, a given CoS Name, and a given time period  $T_k$ .

Table 8 lists the contents of an SLS entry for the One-way Packet Loss Ratio Performance Metric.

Item	Description	Values
Performance Metric	Name of the Performance Metric	One-way Packet Loss Ratio.
$C$	CoS Name	One of the values in the IPVC List of Class of Service Names Service Attribute (section 10.8).
$S$	Set of ordered SLS-RP pairs	A set of ordered SLS-RP pairs as defined in section 10.9.1.
$\hat{F}$	Packet Loss Ratio Objective	Percentage expressed as a real number between 0 and 100%.

**Table 8 – Parameters for One-way Packet Loss Ratio**

**[R35]** If the SLS contains an entry for the One-way Packet Loss Ratio Performance Metric, it **MUST** be defined as follows, for a given set of parameters as specified in Table 8 and a given time period  $T_k$ :

- Let  $I(T_k, C, \langle i, j \rangle)$  be the number of Qualified Packets for time period  $T_k$ , CoS Name  $C$  and ordered pair of SLS-RPs  $\langle i, j \rangle$  in  $S$  that are received at SLS-RP  $i$ .
- Let  $J(T_k, C, \langle i, j \rangle)$  be the number of unique (not duplicate) Qualified Packets for time period  $T_k$ , CoS Name  $C$  and ordered pair of SLS-RPs  $\langle i, j \rangle$  in  $S$  that are transmitted at SLS-RP  $j$ .
- Let  $f(T_k, C, \langle i, j \rangle)$  be defined as:  

$$f(T_k, C, \langle i, j \rangle) = \frac{I(T_k, C, \langle i, j \rangle) - J(T_k, C, \langle i, j \rangle)}{I(T_k, C, \langle i, j \rangle)}$$
 if  $I(T_k, C, \langle i, j \rangle) > 0$   
 $f(T_k, C, \langle i, j \rangle) = 0$  otherwise.
- Then the One-way Packet Loss Ratio Performance Metric  $F(T_k, C, S)$  is the maximum of all the values  $f(T_k, C, \langle i, j \rangle)$  for all  $\langle i, j \rangle$  in  $S$ .

Note that “Qualified Packets for time period  $T_k$ ” always means that the packet arrives at the ingress EI or from the cloud service associated with the SLS-RP during time interval  $T_k$ . Therefore,  $J(T_k,$

$C, \langle i, j \rangle$ ) includes IP Packets that arrived at the EI associated with SLS-RP  $i$  during interval  $T_k$  and were transmitted at the egress EI or towards the cloud service associated with SLS-RP  $j$ , regardless of when they were transmitted.

The Packet Loss Ratio is usually expressed as a percentage.

**[R36]** If the SLS contains an entry for the One-way Packet Loss Ratio Performance Metric, it **MUST** define the objective as being met over time period  $T_k$  for an SLS entry of the form specified in Table 8 if and only if  $F(T_k, C, S) \leq \hat{F}$ .

Note that per the definition above, packets that are eventually delivered are not considered lost, no matter how long the packet delay is.

Note: RFC 7680 [52] defines a metric for one-way loss of packets across Internet paths that is similar to the definition of Packet Loss Ratio in this specification. It builds on notions introduced and discussed in the IP Performance Metrics (IPPM) Framework document, RFC 2330 [11].

### 10.9.9 Service Uptime Performance Metric

The Service Uptime Performance Metric is the proportion of time, during a given time period  $T_k$ , that the service is working from the perspective of the Subscriber (for a Subscriber IP Service) or the perspective of the SP/SO (for an Operator IP Service), excluding any pre-agreed exceptions, for example maintenance intervals.

Table 9 lists the contents of an SLS entry for the Service Uptime Performance Metric.

Item	Description	Values
Performance Metric	Name of the Performance Metric	Service Uptime.
$\hat{U}$	Service Uptime Objective	Percentage between 0 and 100%.

**Table 9 – Parameters for Service Uptime**

**[R37]** If the SLS contains an entry for the Service Uptime Performance Metric, it **MUST** be defined as follows, for a given time period  $T_k$ :

- Let  $O(T_k)$  be the total duration of outages during time period  $T_k$ .
- Let  $M(T_k)$  be the total duration of maintenance periods during time period  $T_k$ .
- Then the Service Uptime,  $U(T_k)$  is defined as:
 
$$U(T_k) = \frac{T - (M(T_k) + O(T_k))}{T - M(T_k)} \quad \text{if } T - M(T_k) > 0;$$

$$1 \quad \text{otherwise.}$$

Note the value  $T$  used in [R37] comes from the four-tuple value of the IPVC SLS Service Attribute (see section 10.9), i.e. it is the duration of  $T_k$ .

- [R38] If the SLS for a Subscriber IP Service includes an entry for the Service Uptime Performance Metric, the Subscriber and SP **MUST** agree on the definition of an outage, including determining when an outage starts and ends.
- [R39] If the SLS for an Operator IP Service includes an entry for the Service Uptime Performance Metric, the SP/SO and the Operator **MUST** agree on the definition of an outage, including determining when an outage starts and ends.

The definition of what constitutes an outage is often (but does not have to be) based on the raising and resolution of customer complaints (“trouble tickets”) rather than the actual performance of data traffic through the network. This definition can be refined based on further commercial considerations, such as exceptions for acts of god or other events beyond the Service Provider’s or Operator’s control. The exact definition is outside the scope of this document.

Service Uptime is generally expressed as a percentage.

- [R40] If the SLS contains an entry for the Service Uptime Performance Metric, it **MUST** define the objective as being met over time period  $T_k$  for an SLS entry of the form specified in Table 9 if and only if  $U(T_k) \geq \hat{U}$ .

## 10.10 IPVC MTU Service Attribute

The IPVC Maximum Transmit Unit (MTU) Service Attribute is an integer  $\geq 576$  that specifies the maximum length in octets of IP Data Packets that the SP or Operator guarantees to be able to carry across the IPVC.

- [R41] For a Subscriber IPVC, the value of the IPVC MTU Service Attribute **MUST** be less than or equal to the minimum of the values of the UNI Access Link IP MTU Service Attribute (see section 13.9) for all of the UNI Access Links in UNIs that the IPVC is attached to.
- [R42] For an Operator IPVC, the value of the IPVC MTU Service Attribute **MUST** be less than or equal to the minimum of the values of the UNI Access Link IP MTU Service Attribute (see section 13.9) for all of the UNI Access Links in UNIs that the IPVC is attached to and the values of the ENNI Link IP MTU Service Attribute (see section 16.6) for all of the ENNI Links that have been assigned an ENNI Service Mapping Context corresponding to the IPVC EP ENNI Service Mapping Identifier Service Attribute (section 11.6) for an IPVC EP in the IPVC at that ENNI.

RFC 791 [1] specifies the minimum MTU for IPv4 Packets as 68 octets; however, it also requires that all devices can handle a packet of length 576 octets (possibly fragmented). This specification strengthens the requirements from RFC 791 [1], by defining the minimum MTU as 576 octets – that is, IPv4 Packets that are shorter than this are guaranteed not to be fragmented or discarded.

RFC 8200 [57] specifies the minimum MTU for IPv6 Packets as 1280 octets; therefore this value is recommended in all cases, and if IPv6 is enabled for this IPVC, it is required.

- [D11] The IPVC MTU **SHOULD** be greater than or equal to 1280 octets.
- [R43] If the IPVC Maximum Number of IPv6 Routes (section 10.6) is greater than 0, the IPVC MTU **MUST** be greater than or equal to 1280 octets.

IP Data Packets with a length greater than the IPVC MTU can be delivered as is, discarded by the SP or Operator, or in the case of IPv4 packets, fragmented within the SP or Operator Network (providing fragmentation is enabled, see section 10.12). Note that in a multipoint service, it might be that packets longer than the IPVC MTU can be delivered between certain pairs of IPVC EPs, but not between others. If the SP or Operator delivers such packets where possible, the Subscriber can make use of this by using Path MTU Discovery (see section 10.11).

- [R44] Ingress IP Data Packets with a length less than or equal to the value of the IPVC MTU Service Attribute **MUST NOT** be discarded or fragmented due to their length.
- [O7] Ingress IP Data Packets with a length strictly greater than the value of the IPVC MTU Service Attribute **MAY** be discarded or (for IPv4) fragmented.

If the SP or Operator receives an IP Data Packet longer than the IPVC MTU, they can choose to discard it or fragment it, if it cannot be delivered. However, fragmentation can impact performance, and hence this can be disabled via the IPVC Fragmentation Service Attribute (section 10.12).

Note that IP Data Packets with length less than or equal to the IPVC MTU are Qualified Packets (see section 10.9.2), provided they meet the other criteria, and hence any Packet Loss Ratio objective in the SLS (see section 10.9.8) applies to them. IP Data Packets longer than the IPVC MTU are not Qualified Packets and hence any objectives in the SLS do not apply to them.

## 10.11 IPVC Path MTU Discovery Service Attribute

The IPVC Path MTU Discovery Service Attribute indicates whether the Service Provider or Operator supports the use of ICMP-based Path MTU Discovery, as specified in RFC 1191 [4] and RFC 8201 [58]. It takes one of two values, *Enabled* or *Disabled*.

- [R45] When the IPVC Path MTU Discovery Service Attribute is *Enabled*, IP routers within the SP Network (for a Subscriber IP Service) or the Operator Network (for an Operator IP Service) **MUST** generate the relevant ICMP error messages when an IP Packet is received that is discarded due to its length (per requirements [O7] and [R47]).

Note that [O7] allows packets longer than the IPVC MTU to be discarded or fragmented if they are not delivered; however, [R47] only allows them to be discarded, if fragmentation is disabled.

- [R46] When the IPVC Path MTU Discovery Service Attribute is *Enabled*, ICMP error messages destined towards a Subscriber Network **MUST NOT** be filtered or discarded.

When IPVC Path MTU Discovery is *Enabled*, hosts within the Subscriber Network can rely on using the mechanisms of RFC 1191 [4] and RFC 8201 [58] to discover the MTU that can be used for transmission of IP Packets to each remote host. Regardless of the value of the IPVC Path MTU Discovery Service Attribute, hosts can use the mechanism of RFC 4821 [34] for path MTU discovery. Depending on the host implementation, hosts might be capable of using a different MTU for each remote host they transmit to, or might select the minimum value of all the hosts they transmit to.

## 10.12 IPVC Fragmentation Service Attribute

The IPVC Fragmentation Service Attribute specifies whether IPv4 Packets that are longer than the IPVC MTU can be fragmented (as described in RFC 791 [1]) as they traverse the IPVC. It takes one of two values, *Enabled* or *Disabled*.

- [R47] When the IPVC Fragmentation Service Attribute is *Disabled*, Ingress IPv4 Data Packets with a length strictly greater than the value of the IPVC MTU Service Attribute **MUST NOT** be fragmented.

Note that when the value is *Enabled*, IP Data Packets that are longer than the IPVC MTU might be delivered, fragmented or discarded, per [O7]. When the value is *Disabled*, such packets are delivered or discarded.

## 10.13 IPVC Cloud Service Attribute

The IPVC Cloud Service Attribute is either *None*, or a set of parameters describing the cloud service as detailed in Table 10 below.

- [R48] If the IPVC Topology Service Attribute (see section 10.2) is *Cloud Access*, the parameters shown in Table 10 **MUST** be specified.
- [R49] If the IPVC Topology Service Attribute (see section 10.2) is not *Cloud Access*, the IPVC Cloud Service Attribute **MUST** be *None*.

Note that the combination of [R7] and [R49] means that the IPVC Cloud Service Attribute is always *None* for an Operator IP Service.

The parameters of a cloud access IPVC are summarized in Table 10 and described in more detail in the following subsections.



Parameter Name	Summary Description	Possible Values
Cloud Type	Indicates the type of cloud service being accessed.	<i>Internet Access</i> or <i>Private</i> .
Cloud Ingress Class of Service Map	Specification of how ingress packets are mapped to different CoS Names.	See section 10.13.2.
Cloud Data Limit	Limit on the amount of Data traffic sent to/received from the cloud service.	<i>Unlimited</i> or a 4-tuple ( $s_{cdl}$ , $T_{cdl}$ , $u_{cdl}$ , $d_{cdl}$ ) as described in section 10.13.3.
Cloud Network Address Translation	Whether Network Address Translation is used, and if so the IPv4 Prefix.	<i>Disabled</i> or an IPv4 Prefix.
Cloud DNS	Whether and how DNS is provided for the service.	<i>None</i> , <i>DHCP</i> , <i>PPP</i> or <i>Static</i> plus a list of DNS Server Addresses.
Cloud Subscriber Prefix List	List of Public IP Prefixes used in the Subscriber Network.	List of IP Prefixes.

**Table 10 – Subscriber IPVC Cloud Service Attribute parameters**

### 10.13.1 Cloud Type

The Cloud Type parameter is *Internet Access* or *Private*. If the value is *Internet Access*, this indicates the cloud access IPVC is used to access the public Internet. If the value is *Private*, this indicates the cloud access IPVC provides a direct connection over the Service Provider’s network to a cloud service such as Amazon Web Services, Google Cloud or Microsoft Azure.

Note: the behavior, parameters and requirements for private cloud access services are deferred to a future revision of this specification.

### 10.13.2 Cloud Ingress Class of Service Map

The Cloud Ingress Class of Service Map is a triple ( $F, M, D$ ) where  $F$  is a list of one or more fields in the packet header that are used to determine the CoS Name,  $M$  is a mapping from combinations of values of those fields to CoS Names, and  $D$  is a default CoS Name used when the map cannot be applied. CoS Names are also known as “Traffic Classes”. The Cloud Ingress Class of Service Map is applied to IP Data Packets that are received from the cloud service. The IPVC EP Ingress Class of Service Map defined in section 11.9 is applied to IP Data Packets received at a UNI and mapped to the IPVC EP.

The possible values that can be included in list  $F$  are:

- *Source IP Address*
- *Destination IP Address*
- *L4 Protocol*
- *Source L4 Port*
- *Destination L4 Port*

Note that *IP DS* is not included in the possible fields, as the DSCP value in IP Packets received from the Internet cannot be relied upon. Matching on the IP DS field might be added in future work on private cloud services.

The map *M* is a set of (key, value) pairs where the key is a tuple containing possible values for the fields specified in list *F*, and the value is one of the CoS Names specified in the IPVC List of Class of Service Names Service Attribute (section 10.8). For example, if *F* contains only *Source IP Address*, then *M* comprises entries of the form (<IP Prefix>, <CoS Name>), such as (192.0.2.176/32, “Best Effort”); if *F* comprises *L4 Protocol* and *Destination L4 Port*, then *M* comprises entries of the form ((<L4 protocol>, <Port Number>), <CoS Name>), such as ((6, 25), “Best Effort”). Note that 6 is the protocol number for TCP, and 25 is the TCP port number for SMTP, so this entry would map email traffic to the “Best Effort” class. Further examples can be found in Appendix B.5.

The value that is included in the key in map *M* for each field specified in list *F* is shown in Table 11.

Field in <i>F</i>	Values in the key in <i>M</i>
<i>Source IP Address</i>	IP Prefix
<i>Destination IP Address</i>	IP Prefix
<i>L4 Protocol</i>	Protocol Number (integer from 0 to 255)
<i>Source L4 Port</i>	Port Number (integer from 0 to 65535)
<i>Destination L4 Port</i>	Port Number (integer from 0 to 65535)

**Table 11 – Values for the Cloud Ingress Class of Service Map**

Note that the Cloud Ingress Class of Service Map does not explicitly distinguish between the handling for IPv4 and IPv6 packets. However, different handling can be specified by including entries in the map that match on *Source IP Address* with the IP Prefix set to 0.0.0.0/0 or ::/0.

The default CoS Name, *D*, is used when the map *M* cannot be applied to the packet, as described below.

- [R50]** The CoS Names used in the map *M* and default *D* in the Cloud Ingress Class of Service Map **MUST** be present in the IPVC List of Class of Service Names (section 10.8) for the corresponding IPVC, or be the special value *Discard*.
- [R51]** IP Data Packets received from the cloud service, that are mapped to the special CoS Name *Discard*, **MUST** be discarded.

Table 12 below shows the criteria for whether an IP Data Packet received from the cloud service matches an entry in map *M* if a given field is included in list *F*.

Field in <i>F</i>	Criteria for matching
<i>Source IP Address</i>	The Source Address in the IP Data Packet is within the IP Prefix in the key in map <i>M</i> , and there is no other matching entry in <i>M</i> that has a more specific IP Prefix.
<i>Destination IP Address</i>	The Destination Address in the IP Data Packet is within the IP Prefix in the key in map <i>M</i> , and there is no other matching entry in <i>M</i> that has a more specific IP Prefix.
<i>L4 Protocol</i>	The Protocol field in the IPv4 header of an IPv4 Data Packet, or the last “Next Header” field in an IPv6 Data Packet matches the value in the key in map <i>M</i> .
<i>Source L4 Port</i>	The IP Data Packet contains a TCP or UDP packet and the Source Port in the TCP or UDP header matches the value in the key in map <i>M</i> .
<i>Destination L4 Port</i>	The IP Data Packet contains a TCP or UDP packet and the Destination Port in the TCP or UDP header matches the value in the key in map <i>M</i> .

**Table 12 – Matching Criteria for the Cloud Ingress Class of Service Map**

In the case of *L4 Protocol*, for an IPv6 Packet, the relevant field is the “Next Header” field in the IPv6 header, if it does not indicate an IPv6 extension header, otherwise the “Next Header” field in the last IPv6 extension header.

*When establishing a TCP connection to a server, the destination port is normally well known whereas the source port is typically chosen arbitrarily by the client. However, responses from the server to the client use the well known number as the source port, and the arbitrarily chosen number as the destination port. In this case, matching the source port can be useful.*

The criteria for matching the source or destination address allow for the case where map *M* contains entries with overlapping IP Prefixes (and the same values for any other fields). In this case, the entry with the most specific IP Prefix (i.e. the longest prefix length) is used (“longest prefix matching”). The following requirement ensures that when both source and destination addresses are matched, a single entry can be selected unambiguously.

- [R52] If list *F* contains both *Source IP Address* and *Destination IP Address*, map *M* **MUST NOT** contain any pair of entries in which the IP Prefixes for Source IP Address overlap, the IP Prefixes for Destination IP Address overlap, the IP Prefix for the Source Address is more specific in one entry and the IP Prefix for the Destination Address is more specific in the other entry.
- [R53] An IP Data Packet received from the cloud service that matches an entry in map *M* as specified in Table 12, for the fields specified in list *F*, **MUST** be assigned the corresponding CoS Name from the map *M*.
- [R54] An IP Data Packet received from the cloud service that does not match any entry in map *M* as specified in Table 12, for the fields specified in list *F*, **MUST** be assigned the default CoS Name, *D*.

*Note that the Ingress Class of Service Map is often implemented with an ACL or QoS marking policy; however, this specification does not mandate any particular implementation.*

### 10.13.3 Cloud Data Limit

The Cloud Data Limit parameter specifies an absolute limit on the amount of data the Subscriber can transmit to, or receive from, the cloud service in a given time period. It is either *Unlimited* or a 4-tuple  $(s_{cdl}, T_{cdl}, u_{cdl}, d_{cdl})$  where:

- $s_{cdl}$  (for start time) specifies a start time.
- $T_{cdl}$  (for duration) specifies a duration (for example, 1 month). Together with the start time, it describes a series of contiguous time intervals, starting at the specified start time and each lasting for the specified duration.
- $u_{cdl}$  (for upload) is an integer indicating a limit, in octets, on the amount of IP traffic that can be transmitted towards the cloud service during each time interval described by  $s_{cdl}$  and  $T_{cdl}$ .
- $d_{cdl}$  (for download) is an integer indicating a limit, in octets, on the amount of IP traffic received from the cloud service that can be delivered to the Subscriber during each time interval described by  $s_{cdl}$  and  $T_{cdl}$ .

In this context, the amount of IP traffic is calculated by summing the lengths of the IP Data Packets transmitted towards or received from the cloud service, as appropriate.

**[O8]** If the Cloud Data Limit for an IPVC is a 4-tuple  $(s_{cdl}, T_{cdl}, u_{cdl}, d_{cdl})$ , within each time interval described by  $s_{cdl}$  and  $T_{cdl}$ , an Ingress IP Data Packet mapped to an IPVC EP for the IPVC **MAY** be discarded if the sum of the lengths of all previous Ingress IP Data Packets mapped to an IPVC EP for this IPVC and transmitted towards the cloud service during the same time interval exceeds the limit  $u_{cdl}$ .

**[O9]** If the Cloud Data Limit for an IPVC is a 4-tuple  $(s_{cdl}, T_{cdl}, u_{cdl}, d_{cdl})$ , within each time interval described by  $s_{cdl}$  and  $T_{cdl}$ , an IP Data Packet received from the cloud service **MAY** be discarded if the sum of the lengths of all previous IP Data Packets received from the cloud service and mapped to an egress IPVC EP for this IPVC during the same time interval exceeds the limit  $d_{cdl}$ .

When the limit is exceeded, the SP might discard all packets (e.g. unless and until the Subscriber obtains an extension to the service), or they might restrict the bandwidth, resulting in some but not all packets being discarded. They might not discard any packets if, for example, they have the facility to automatically bill the Subscriber for the extra usage above the limit. Such details are typically specified in an SLA and are outside the scope of this document.

Note that this limit is agreed between the SP and the Subscriber. If the Subscriber is accessing a content provider within the cloud service, the content provider might also have their own limits. These would likely be unknown to the SP; it is the Subscriber's responsibility to make sure the limits agreed with the SP are sufficient for their needs.

### 10.13.4 Cloud Network Address Translation

The Cloud Network Address Translation (NAT) parameter is either *Disabled* or an IPv4 Prefix. An IPv4 Prefix can be specified for Internet access services, in which case NAT is enabled and

any IPv4 addresses used by the Subscriber are translated to an address in the given IPv4 Prefix. Note that the IPv4 Prefix can be specified with a prefix length of 32, in which case it corresponds to a single IPv4 address. This can be useful, for example, when the Subscriber needs a fixed IPv4 address.

- [R55] If the Cloud Type parameter is *Internet Access*, when the Cloud NAT parameter is not *Disabled*, it **MUST** be a publicly assigned IPv4 Prefix.
- [R56] When the Cloud NAT parameter is an IPv4 Prefix, IPv4 Packets transmitted towards or received from the cloud service **MUST** be subject to behavior consistent with Network Address Translation and Network Address Port Translation as described in RFC 3022 [18], using an IPv4 address in the specified IPv4 Prefix.

Note that the SP might perform multiple stages of NAT; this is consistent with RFC 3022 [18] and hence compliant with [R56] provided that the IP address eventually used to send/receive IP packets to/from the Internet is within the specified IPv4 Prefix. The IPv4 address used in any intermediate stages of NAT need not be from a publicly assigned IPv4 Prefix.

- [R57] When the Cloud NAT parameter is an IPv4 Prefix, the SP **MUST** ensure that the best current practice documented in RFC 4787 [33], RFC 5382 [37], RFC 5508 [40], RFC 5597 [41] and RFC 7857 [54] is followed.

Note that if different NAT is required at different UNIs that all have internet access, this can be achieved by instantiating a separate cloud access IPVC for each UNI.

### 10.13.5 Cloud DNS Service

The Cloud DNS Service parameter indicates whether and how a DNS service (as described in RFC 1034 [3]) is provided to the Subscriber by the SP. The possible values are *None*, *DHCP*, *SLAAC*, *PPP* or *Static*, plus in the case of *Static*, a non-empty list of DNS server IP addresses. If the value is *None*, the SP does not provide a DNS service. If the value is *DHCP*, the SP provides DNS server addresses via DHCP at each UNI (this is only possible if DHCP is used for the connection addressing). If the value is *SLAAC*, the SP provides DNS server addresses via SLAAC Router Advertisement options (per RFC 8106 [55]) at each UNI (this is only possible if SLAAC is used for the connection addressing). If the value is *PPP*, the SP provides DNS server addresses via PPP at each UNI (this is only possible if the underlying L2 Technology uses PPP – see section 13.3). If the value is *Static*, the DNS server addresses are listed explicitly.

- [R58] If the value of the Cloud DNS Service parameter is *DHCP*, every UNI that the IPVC is attached to **MUST** contain at least one UNI Access Link with IPv4 Connection Addressing Type (see section 13.4) equal to *DHCP* or IPv6 Connection Addressing Type (see section 13.5) equal to *DHCP*.
- [R59] If the value of the Cloud DNS Service parameter is *SLAAC*, every UNI that the IPVC is attached to **MUST** contain at least one UNI Access Link with IPv6 Connection Addressing Type (see section 13.5) equal to *SLAAC*.

- [R60] If the Cloud Type parameter (see section 10.13.1) is not *Internet Access*, the Cloud DNS Service parameter **MUST** be *None*.

### 10.13.6 Cloud Subscriber Prefix List

The Cloud Subscriber Prefix List parameter is a list of public IP Prefixes that are used in the Subscriber Network. Agreeing on this list allows the SP to implement security filtering for traffic to or from IP addresses that are not within the listed prefixes.

The list can be empty, or can contain IPv4 or IPv6 Prefixes or both. The listed prefixes might have been allocated to the Subscriber by the SP, or from some other source (e.g. another SP or a Regional Internet Registry).

- [R61] If the Cloud Type parameter (see section 10.13.1) is not *Internet Access*, the Cloud Subscriber Prefix List **MUST** be empty.

If NAT is enabled, the Subscriber's addresses are translated by the SP so this parameter is not needed.

- [R62] If the Cloud Network Address Translation parameter (see section 10.13.4) is not *Disabled*, the Cloud Subscriber Prefix List **MUST** be empty.

It is not necessary to list the IP Prefixes corresponding to the UNI Access Link connection addresses – these addresses are always allowed by the SP. IP Data Packets from outside the connection subnets, that are not listed in the Subscriber Prefix List, can be discarded.

- [O10] If the Cloud Type parameter (see section 10.13.1) for a cloud access IPVC is *Internet Access*, an Ingress IP Data Packet that is mapped to the IPVC at a UNI, with a source IP address that is not within the IP Prefix identified by the UNI Access Link Connection Addressing Service Attributes (see sections 13.4 and 13.5) and is not within an IP Prefix contained in the Cloud Subscriber Prefix List, **MAY** be discarded.

- [O11] If the Cloud Type parameter (see section 10.13.1) for a cloud access IPVC is *Internet Access*, an Egress IP Data Packet that is mapped to the IPVC at a UNI, with a destination IP address that is not within the IP Prefix identified by the UNI Access Link Connection Addressing Service Attributes (see sections 13.4 and 13.5) and is not within an IP Prefix contained in the Cloud Subscriber Prefix List, **MAY** be discarded.

Note that if different filtering is required at different UNIs that all have internet access, this can be achieved by instantiating a separate cloud access IPVC for each UNI.

Note also that if the Cloud Subscriber Prefix List is an empty list, the SP might discard all IP Packets other than those with source or destination IP addresses matching the UNI Access Link connection addresses. If the desired behavior is that the SP does not discard any IP Packets, this can be achieved by specifying a Cloud Subscriber Prefix List containing 0.0.0.0/0 and ::/0.

## 10.14 IPVC Reserved Prefixes Service Attribute

The IPVC Reserved Prefixes Service Attribute specifies a list of IP Prefixes that the SP or Operator reserves for use for the IPVC within their own network, but which are nevertheless exposed to the Subscriber, for example for diagnostics purposes. The list can be empty, or can contain IPv4 or IPv6 Prefixes or both. These IP Prefixes need to be agreed so as to ensure they do not overlap with IP Prefixes used by the Subscriber inside the Subscriber Network.

**[R63]** For a Subscriber IP Service, the Subscriber **MUST NOT** use IP addresses that are within the IP Prefixes listed in the IPVC Reserved Prefixes Service Attribute for devices in the Subscriber Network.

Note that for an Operator IP Service, the Operator may need to agree on their reserved prefixes with the SP in order that the SP can then agree on them with the Subscriber for the corresponding Subscriber IP Service.

One possible use for the IPVC Reserved Prefixes Service Attribute is if the SP exposes the IP addresses for loopback interfaces on their PE devices (or at Provider-Managed UNIs, their CE devices) to the Subscriber; this can help the Subscriber diagnose network problems using tools like ping and traceroute.

Note that it is not necessary to reserve the SP's IP address on the directly connected subnet for a UNI Access Link using this attribute; such addresses are automatically reserved. See sections 13.4 and 13.5.

## 11 IPVC End Point Service Attributes

This section specifies the Service Attributes for IP Services that apply to each IPVC attached to a given UNI or ENNI, i.e. to each IPVC EP. There is one instance of these attributes for each IPVC EP at a UNI or ENNI. These attributes apply to IPVC EPs for both Subscriber IPVCs and Operator IPVCs unless otherwise stated. In the case of a Subscriber IP Service, the Service Attributes are agreed between the Subscriber and an SP, and the SP has responsibility for delivering the service (i.e. most requirements are on the SP). In the case of an Operator IP Service, the Service Attributes are agreed between an SP/SO and an Operator, and the Operator has responsibility for delivering the service (i.e. most requirements are on the Operator). The attributes are summarized in Table 13 and described in more detail in the following subsections.

Attribute Name	Summary Description	Possible Values
IPVC EP Identifier	Unique identifier for the IPVC EP for management purposes.	Printable string that is unique across the SP's or Operator's network.
IPVC EP EI Type	Indicates whether the IPVC EP is at a UNI or an ENNI. (Operator IPVC EPs only).	<i>UNI</i> or <i>ENNI</i> .
IPVC EP EI	The EI where the IPVC EP is located.	UNI Identifier of a UNI or ENNI Identifier of an ENNI.
IPVC EP Role	Role of the IPVC EP in a rooted multipoint IPVC.	<i>Root</i> , <i>Leaf</i> or <i>Trunk</i> .
IPVC EP Prefix Mapping	Indicates which IP Prefixes can send and receive traffic to/from the IPVC.	List of IP Prefixes.
IPVC EP ENNI Service Mapping Identifier	ENNI Service Mapping Identifier assigned by the SP/SO for associating IPVC EPs across an ENNI. (Operator IPVC EPs only).	Printable string.
IPVC EP Maximum Number of IPv4 Routes	Maximum number of IPv4 routes supported by this IPVC EP.	Integer $\geq 0$ or <i>Unlimited</i> .
IPVC EP Maximum Number of IPv6 Routes	Maximum number of IPv6 routes supported by this IPVC EP.	Integer $\geq 0$ or <i>Unlimited</i> .
IPVC EP Ingress Class of Service Map	Specification of how ingress packets are mapped to different CoS Names.	See section 11.9.
IPVC EP Egress Class of Service Map	Specification of how Class of Service is indicated in egress packets.	See section 11.10.
IPVC EP Ingress Bandwidth Profile Envelope	Ingress Bandwidth Profile Envelope for the IPVC EP.	<i>None</i> or a set of parameters as described in section 17.3.



Attribute Name	Summary Description	Possible Values
IPVC EP Egress Bandwidth Profile Envelope	Egress Bandwidth Profile Envelope for the IPVC EP.	<i>None</i> or a set of parameters as described in section 17.3.

**Table 13 – IPVC EP Service Attributes**

### 11.1 IPVC EP Identifier Service Attribute

The IPVC EP Identifier is a unique string identifier for the IPVC EP. For Subscriber IP Services, it can be used by the Subscriber and the SP to identify the IPVC EP to each other. For Operator IP Services, it can be used by the SP/SO and the Operator to identify the IPVC EP to each other.

- [R64] The IPVC EP Identifier **MUST** consist only of ASCII characters in the range 32-126 inclusive.
- [R65] The length of the IPVC EP Identifier **MUST** be less than or equal to 53 characters.
- [R66] The value of the IPVC EP Identifier **MUST** be unique among all such identifiers for IPVC EPs supported by the Service Provider or Operator.

### 11.2 IPVC EP EI Type Service Attribute

The IPVC EP EI Type Service Attribute specifies whether the IPVC EP is located at a UNI or an ENNI. The possible values are *UNI* or *ENNI*. It is only used for IPVC EPs for Operator IP Services and is not specified for Subscriber IP Services. For Subscriber IP Services, IPVC EPs can only be located at UNIs.

### 11.3 IPVC EP EI Service Attribute

The IPVC EP EI Service Attribute specifies the UNI or ENNI where this IPVC EP is located. Its value is a UNI Identifier (see section 12.1) for one of the UNIs supported by the SP or Operator, or an ENNI Identifier (see section 14.1) for one of the ENNIs supported by the Operator. For a Subscriber IP Service, the value is always a UNI Identifier, which is all that is needed to uniquely identify the location of the IPVC EP. For an Operator IP Service, this attribute is used in conjunction with the IPVC EP EI Type Service Attribute (section 11.2) to uniquely identify the location of the IPVC EP.

- [R67] For a Subscriber IP Service, the IPVC EP EI Service Attribute **MUST** be a UNI Identifier (see section 12.1) for one of the UNIs supported by the Service Provider.
- [R68] For an Operator IP Service, if the IPVC EP EI Type Service Attribute (section 11.2) is *UNI*, the IPVC EP EI Service Attribute **MUST** be a UNI Identifier (see section 12.1) for one of the UNIs supported by the Operator.

- [R69] For an Operator IP Service, if the IPVC EP EI Type Service Attribute (section 11.2) is *ENNI*, the IPVC EP EI Service Attribute **MUST** be an ENNI Identifier (see section 14.1) for one of the ENNIs supported by the Operator.

#### 11.4 IPVC EP Role Service Attribute

The IPVC EP Role Service Attribute is one of *Root*, *Leaf*, or *Trunk*, and specifies the role the IPVC EP plays in the IPVC topology.

- [R70] An IPVC EP for a multipoint IPVC **MUST** have an IPVC EP Role of *Root*.

*Trunk* role is used in an Operator IP Service at an ENNI, when the IPVC EP carries both traffic to/from IPVC EPs with root role and IPVC EPs with leaf role.

- [R71] An IPVC EP at a UNI **MUST NOT** have an IPVC EP Role of *Trunk*.

- [R72] A rooted multipoint IPVC **MUST** either have IPVC EPs with at least two different roles, or have only IPVC EPs with a role of *Trunk*.

[R72] precludes having a rooted multipoint IPVC that has only Root IPVC EPs (which would be indistinguishable from a multipoint IPVC) or only Leaf IPVC EPs (where no traffic can flow between any IPVC EPs).

IPVC EPs for a cloud access IPVC can have either *Root* or *Leaf* role. The cloud service itself always acts as if it has *Root* role.

In a rooted multipoint or cloud access IPVC, traffic can flow between roots and leaves, or between two roots, but not between two leaves.

- [R73] An Ingress IP Data Packet mapped to an IPVC EP with IPVC EP Role of *Leaf* **MUST NOT** be transmitted as an Egress IP Data Packet at an IPVC EP with IPVC EP Role of *Leaf*.

Note: The description in section 9 means that if standard routing is used in the IPVC, adhering to [R16] and [R17] automatically ensures compliance with [R73].

When *Trunk* role is used at an ENNI, it is the SP/SO's responsibility to ensure that the IPVC EPs on either side of the ENNI both have *Trunk* role. In this case, additional information is needed at the ENNI to ensure that traffic originally mapped to an IPVC EP with *Leaf* role in one Operator IPVC is not delivered to an IPVC EP with *Leaf* role in the other Operator IPVC, after having crossed the ENNI. This can be done either by ensuring the IP Packets are marked differently when they cross the ENNI depending on whether they came originally from a leaf or a root, or if both Operator IPVCs use standard IP routing, by controlling how routes received over the ENNI are distributed.

- [R74] If an Ingress IP Data Packet mapped to an IPVC EP with IPVC EP Role of *Leaf* is transmitted as an Egress IP Data Packet at an IPVC EP with IPVC EP Role of *Trunk* at an ENNI using Option A, the Operator **MUST** ensure that the

packet has a destination address that matches a route for an IP Prefix received at the ENNI marked as being for a root.

Note that the marking of routes as being from a root or from a leaf is specified using the ENNI Routing Common Attribute (section 15.5). Requirements for ENNIs that do not use Option A are deferred and may be specified in a future version of this document. Likewise, marking of packets at an ENNI to indicate whether they came from a leaf or a root is deferred and may be specified in a future version of this document.

Note also that the description in section 9 means that if standard routing is used in the IPVC, adhering to [R16] automatically ensures compliance with [R74].

## 11.5 IPVC EP Prefix Mapping Service Attribute

The IPVC EP Prefix Mapping Service Attribute is a list, possibly empty, of IP Prefixes (that is, subnet and prefix length). It is used to specify which subnets within the Subscriber Network can access the IPVC via this IPVC EP. If the list is empty, there are no restrictions and packets to or from any address within the Subscriber Network can be mapped to this IPVC EP on ingress or delivered to this IPVC EP on egress. If the list is non-empty, Ingress IP Packets that are not from within one of the specified IP Prefixes are not mapped to this IPVC EP, and only IP Packets delivered across the IPVC that are destined towards one of the specified IP Prefixes are delivered to this IPVC EP on egress. As described in section 9, in IPVCs that use standard routing, this is achieved by only making the specified IP Prefixes available for routing in the IPVC.

The IPVC EP Prefix Mapping attribute can also affect how IP Packets are mapped to an IPVC EP. An overview of this is given in section 9.3. In particular, when there are multiple IPVC EPs at an UNI (for different IPVCs), it is possible for an Ingress IP Data Packet at that UNI to be eligible to be mapped to more than one of them. Section 11.5.1 describes how the appropriate IPVC EP is chosen, based on the value of the IPVC EP Prefix Mapping Service Attribute.

At an ENNI, the IPVC EP Prefix Mapping Service Attribute is only applicable if the ENNI uses Option A.

- [R75]** For an IPVC EP at an ENNI, if the ENNI Type Service Attribute (section 14.2) is not *Option A*, the IPVC EP Prefix Mapping Service Attribute **MUST** be an empty list.

The following requirements describe the effect of the IPVC EP Prefix Mapping Service Attribute.

- [R76]** For an IPVC EP for an IPVC with IPVC Packet Delivery (section 10.4) set to *Standard Routing*, if the IPVC EP Prefix Mapping Service Attribute is not an empty list, an IP Prefix **MUST NOT** be made available for routing within the IPVC unless either the IP Prefix or a superset of it is included in the list.

Referring to the description in section 9, [R76] could be equivalently stated as saying that if the IPVC EP Prefix Mapping Service Attribute is set, routes for IP Prefixes that are not specified in the IPVC EP Prefix Mapping Service Attribute are not propagated from  $RID_{UNI}$  for the UNI where

the IPVC EP is located, or from  $RID_{SC}$  or  $RID_{SCL}$  for the IPVC EP's ENNI Service Mapping Context at the ENNI where the IPVC EP is located, into  $RID_L$  or  $RID_{LL}$  for the IPVC EP.

- [R77]** If the IPVC EP Prefix Mapping Service Attribute is not an empty list, IP Data Packets delivered across the IPVC for the IPVC EP, that have a Destination Address that is not within any of the listed IP Prefixes, **MUST NOT** be delivered as Egress IP Packets at the EI where the IPVC EP is located.

Note that in IPVCs that use standard IP routing, [R76] ensures that only IP Prefixes included in the Prefix Mapping list (if it is not empty) are added to the list of IP Prefixes that are reachable via this IPVC EP. In addition, [R16] and [R17] mean that a unicast packet with a destination address that is not reachable via any IPVC EP for the IPVC is discarded. Together, this means that a unicast IP Data Packet with a destination address that is not within any of the listed IP Prefixes cannot be delivered to this IPVC EP; and thus [R77] is always met in this case. In an IPVC that uses policy based routing (PBR), [R76] does not apply but [R77] must still be met.

- [R78]** If the IPVC EP Prefix Mapping Service Attribute is not an empty list, Ingress IP Data Packets with a Source Address that is not within any of the listed IP Prefixes **MUST NOT** be mapped to the IPVC EP.

If the IPVC EP Prefix Mapping Service Attribute is an empty list, this has the same effect as if the attribute value contains two entries, for 0.0.0.0/0 (IPv4) and ::/0 (IPv6). In the latter case, all IP packets match one of these entries and can therefore access the IPVC via this IPVC EP, just as if the attribute were not set.

Some examples illustrating the use of the IPVC EP Prefix Mapping Service Attribute can be found in Appendix B.

### 11.5.1 Mapping IP Data Packets to an IPVC

When there are multiple IPVC EPs at a UNI (each corresponding to a different IPVC), an Ingress IP Data Packet is eligible to be mapped to any of them. However, only one IPVC EP is chosen as the ingress IPVC EP for the packet. Assuming all of the corresponding IPVCs use standard IP routing, this is done by finding the IPVC in which the destination address in the IP Packet is reachable – that is, the IPVC with an IPVC EP that has an IP Prefix best matching the destination address in its routing table  $RT_{IPVCEP}$  (see section 9). *This is typically implemented by a routing lookup.* When there is more than one such IPVC EP, the source address in the packet is matched against the IPVC EP Prefix Mapping Service Attribute to determine which IPVC EP the packet is to be mapped to.

It is important that there is only one IPVC that can be chosen, so that the correct IPVC attributes (e.g. the IPVC SLS) are applied to the packet. When all the IPVCs attached to a UNI use standard routing, the requirements below ensure that a single IPVC EP can be chosen for each Ingress IP Packet. Selection of the ingress IPVC EP when one or more of the corresponding IPVCs uses Policy-Based Routing (see section 10.4), is deferred to a future version of this specification.

Note that the case where there are multiple IPVC EPs with a given ENNI Service Mapping Context at an ENNI using Option A is out of scope of this document (but may be specified in a future

revision). Given the constraint that there is at most one IPVC EP with a given ENNI Service Mapping Context at an ENNI using Option A, there is at most one IPVC EP that an Ingress IP Data packet can be mapped to at that ENNI.

The requirements below apply to unicast IP Packets. Handling of multicast IP Packets is deferred and could be addressed in a future version of this specification.

In the case where a given prefix is reachable in more than one IPVC EP at a UNI, the SP or Operator might or might not be able to route the packet differently depending on the IPVC selected, as described in section 9.3.1.1. If the SP or Operator does not have this capability, the routes in all the IPVC EPs are required to point to the same egress EI; this enables the route to be determined independently of the IPVC EP.

- [O12]** When there are multiple IPVC EPs at a UNI for IPVCs that all have IPVC Packet Delivery (section 10.4) set to *Standard Routing*, and when a given IP Prefix is reachable in more than one of the IPVC EPs, the SP or Operator **MAY** support the capability to deliver ingress IP Data Packets at the UNI via different egress EIs based on which IPVC EP the packet is mapped to on ingress.
- [R79]** If the SP or Operator does not support the capability described in [O12], then for any pair of IPVC EPs at a given UNI, for IPVCs that both have IPVC Packet Delivery (section 10.4) set to *Standard Routing*, if a given IP Prefix is reachable in both IPVC EPs, the best active route for the IP Prefix via one IPVC EP **MUST** be through a UNI Access Link in the same UNI or an ENNI Link in the same ENNI (and with the same ENNI Service Mapping Context) as the best active route for the IP Prefix via the other IPVC EP.

Referring to the description in section 9, an IP Prefix is reachable in an IPVC EP if it has an active route in  $RT_{IPVCEP}$ . [R79] can be equivalently stated as meaning that if two IPVC EPs at a UNI each have a route for the same IP Prefix in their  $RT_{IPVCEP}$  Routing Tables, they have to both be routes towards the same egress UNI or ENNI. The egress EI could be the same as the ingress EI (i.e. the EI where the IPVC EPs are located), or it could be a different EI – the requirement applies either way. Note that implementations are not required to use the routing information databases described in section 9, provided that the external behavior is the same.

[R79] allows for overlapping, but not identical, IP Prefixes to be reachable via different routes in different IPVCs – in this case the most specific matching IP Prefix is preferred (“longest prefix matching”). Note that this precludes a default route (i.e. 0/0 or ::/0) being reachable from a given EI via different routes in different IPVCs.

- [R80]** If:
- Two IPVCs each have an IPVC EP at a given UNI; and
  - Both IPVCs have IPVC Packet Delivery (section 10.4) set to *Standard Routing*; and
  - There is an IP Prefix that is reachable from both IPVC EPs, and in at least one of them, this is via a UNI Access Link that is not in the UNI where the IPVC EPs are located or is via an ENNI;

Then the following conditions **MUST** be met:

- Each IPVC EP has a non-empty value for the IPVC EP Prefix Mapping Service Attribute; and
- The values of the IPVC EP Prefix Mapping Service Attribute for the two IPVC EPs do not contain any IP Prefixes that overlap.

[R80] means that if an IP Prefix is reachable in two different IPVCs, then it is always possible to use the IPVC EP Prefix Mapping values to determine which IPVC EP to map an Ingress IP Packet to, because each of the IPVC EPs has to have the attribute set (i.e. non-empty), and the same prefix can only appear in the attribute value for one of the IPVC EPs.

There is an important exception case in [R80]: when multiple IPVC EPs all have a route to an IP Prefix that directs packets back out of the ingress UNI, the requirement does not apply. In this case, it is not possible to unambiguously choose a particular IPVC EP to map the packet to, and there is no way to determine which IPVC EP was selected. Typically this does not matter as the externally-visible behavior is the same whichever IPVC EP is selected – i.e., packets will be transmitted back out of the UNI where they were received (although not necessarily over the same UNI Access Link), rather than being transmitted across the SP or Operator Network.

The above requirement allows for four possibilities for a given IP Prefix at a UNI, as described in section 9.3.1.1 and with reference to the routing information databases described in section 9.1:

- None of the IPVC EPs have a route to the IP Prefix in their  $RT_{IPVCEP}$ .
- Exactly one of the IPVC EPs has a route to the IP Prefix in its  $RT_{IPVCEP}$ .
- Two or more of the IPVC EPs have a route to the IP Prefix in their  $RT_{IPVCEP}$ , and the best active route in at least one of these points to a UNI Access Link in a remote UNI, or an ENNI Link in a remote ENNI – that is, it comes from a route in  $RID_R$ . In addition, all of the IPVC EPs have the IPVC EP Prefix Mapping attribute set, with disjoint lists of IP Prefixes.
- Two or more of the IPVC EPs have a route to the IP Prefix in their  $RT_{IPVCEP}$ , and the best active route in all of these points to a UNI Access Link in the UNI where the IPVC EPs are located – that is, it comes from a route in  $RID_L$ .

Given these constraints, an ingress IPVC EP is chosen for Ingress IP Data Packets at a UNI as described in section 9.3.1.1. Note that there is no need to select an IPVC EP for Ingress IP Control Protocol Packets (as identified by the UNI List of Control Protocols Service Attribute, see section 12.6).

**[R81]** When all of the IPVC EPs at a given UNI are for IPVCs with the IPVC Packet Delivery (section 10.4) set to *Standard Routing*, a unicast Ingress IP Data Packet at the UNI **MUST** be mapped to an IPVC EP in accordance with the description in section 9.3.1.1.

At an ENNI using Option A, an ingress IPVC EP is chosen for Ingress IP Data Packets by matching the ENNI Service Mapping Context assigned to the ENNI Link that the packet was received over (using the ENNI Service Map Common Attribute, section 15.6.1), as described in section 9.3.1.2.

Again, there is no need to select an IPVC EP for Ingress IP Control Protocol Packets (as identified by the ENNI List of Control Protocols Common Attribute, see section 15.4).

- [R82]** When all of the IPVC EPs with a given ENNI Service Mapping Context at a given ENNI that uses Option A are for IPVCs with the IPVC Packet Delivery (section 10.4) set to *Standard Routing*, a unicast Ingress IP Data Packet received over an ENNI Link with that ENNI Service Mapping Context at the ENNI **MUST** be mapped to an IPVC EP in accordance with the description in section 9.3.1.2.

[R81] and [R82] do not require that implementations follow the exact steps in sections 9.3.1.1 and 9.3.1.2, or that implementations maintain routing information databases per IPVC EP as described in section 9.1. Any implementation that exhibits the same externally-visible behavior is acceptable.

*Note that the requirements above do not necessitate that multiple routing lookups be performed in order to determine the correct IPVC EP; a common implementation is to insert the IP Prefixes associated with the IPVC EPs for all of the IPVCs attached to a given UNI or a given set of ENNI Links into a single routing table (VRF) and use this single table for routing lookups. [R79] ensures that if a prefix is reachable in multiple IPVCs, it is reachable via the same path; hence it is not necessary to consider the IPVC EP Prefix Mapping attribute in order to determine how to route a packet, unless the SP or Operator supports this capability. Depending on the SP's or Operator's network and service implementation, it might be necessary to use the prefix mapping attribute to filter the packet (e.g. using an Access Control List) or to affect quality of service (e.g. using a QoS policy to mark packets differently depending on the IPVC EP Ingress CoS Map (see section 11.9) for different IPVC EPs). Details of the implementation are outside the scope of this document.*

## 11.6 IPVC EP ENNI Service Mapping Identifier Service Attribute

The IPVC EP ENNI Service Mapping Identifier is a string identifier that is used at an ENNI to match the IPVC EP on one side of the ENNI with IPVC EPs on the other side. It is only used for IPVC EPs at ENNIs and is not specified for IPVC EPs at UNIs. Consequently, it is never specified for Subscriber IP Services, which only have IPVC EPs at UNIs.

- [R83]** The IPVC EP ENNI Service Mapping Identifier **MUST** consist only of ASCII characters in the range 32-126 inclusive.
- [R84]** The length of the IPVC EP ENNI Service Mapping Identifier **MUST** be less than or equal to 53 characters.

As described in section 8.6, the IPVC EP ENNI Service Mapping Identifier is used by the SP/SO to match IPVC EPs in one Operator with IPVC EPs in the other Operator at an ENNI. The two Operators map each ENNI Service Mapping Identifier for a given SP/SO to a set of ENNI Links (for an ENNI using Option A), via the ENNI Service Map Common Attribute (section 15.6).

It is not precluded for the same ENNI Service Mapping Identifier to be assigned to two (or more) IPVC EPs in the same Operator at an ENNI (necessarily for different IPVCs); however, the behavior and requirements in this case are out of scope for this document. This specification only

describes the case where the SP/SO assigns a unique ENNI Service Mapping Identifier to each IPVC EP that they agree with an Operator at a given ENNI. (Note that the same ENNI Service Mapping Identifier also needs to be assigned to an IPVC EP agreed with the other Operator, on the other side of the ENNI).

## 11.7 IPVC EP Maximum Number of IPv4 Routes Service Attribute

The IPVC EP Maximum Number of IPv4 Routes Service Attribute limits the total number of IPv4 Prefixes that can be associated with this IPVC EP, i.e. it limits the number of IPv4 routes towards the EI where the IPVC EP is located. It is an integer  $\geq 0$  or the special value *Unlimited*. With reference to the description in section 9, it is a limit on the number of unique IPv4 Prefixes contained in RID<sub>L</sub> or RID<sub>LL</sub> for the IPVC EP.

- [D12] If the IPVC EP Maximum Number of IPv4 Routes Service Attribute is not *Unlimited*, the SP or Operator **SHOULD** disregard any IPv4 Prefixes associated with the IPVC EP above the limit specified by the IPVC EP Maximum Number of IPv4 Routes Service Attribute.
- [D13] When the limit specified by the IPVC EP Maximum Number of IPv4 Routes Service Attribute is reached or exceeded, the SP or Operator **SHOULD** select IPv4 Prefixes to disregard so as to minimize disruption to the service.

[D12] means that if the Subscriber advertises too many routes to the SP or Operator, the SP or Operator might disregard some of them. This can lead to blackholing of some of the Subscriber's traffic, or other undesirable behavior. The SP or Operator can minimize disruption by disregarding the most recently received IPv4 Prefixes so as to maintain the paths that were previously working.

Note that the IPVC EP Maximum Number of IPv4 Routes Service Attribute limits the number of IPv4 routes at this IPVC EP, over the EI where the IPVC EP is located. This document also specifies a limit on the total number of IPv4 routes in the IPVC – see section 10.5.

It can be useful for the SP or Operator to notify the Subscriber or SP/SO (respectively) when the total number of IPv4 Prefixes that are associated with the IPVC EP is approaching the limit specified by the IPVC EP Maximum Number of IPv4 Routes Service Attribute, or has crossed it. The details of how this is done are outside the scope of this document.

- [D14] The SP or Operator **SHOULD** notify the Subscriber or SP/SO (respectively) when the total number of IPv4 Prefixes that are associated with the IPVC EP reaches the value of the IPVC EP Maximum Number of IPv4 Routes Service Attribute.
- [O13] The SP or Operator **MAY** notify the Subscriber or SP/SO (respectively) when the total number of IPv4 Prefixes that are associated with the IPVC EP is approaching the value of the IPVC EP Maximum Number of IPv4 Routes Service Attribute.



## 11.8 IPVC EP Maximum Number of IPv6 Routes Service Attribute

The IPVC EP Maximum Number of IPv6 Routes Service Attribute limits the total number of IPv6 Prefixes that can be associated with this IPVC EP, i.e. it limits the number of IPv6 routes towards the EI where the IPVC EP is located. It is an integer  $\geq 0$  or the special value *Unlimited*. With reference to the description in section 9, it is a limit on the number of unique IPv6 Prefixes contained in  $RID_L$  or  $RID_{LL}$  for the IPVC EP.

- [D15] If the IPVC EP Maximum Number of IPv6 Routes Service Attribute is not *Unlimited*, the SP or Operator **SHOULD** disregard any IPv6 Prefixes associated with the IPVC EP above the limit specified by the IPVC EP Maximum Number of IPv6 Routes Service Attribute.
- [D16] When the limit specified by the IPVC EP Maximum Number of IPv6 Routes Service Attribute is reached or exceeded, the SP or Operator **SHOULD** select IPv6 Prefixes to disregard so as to minimize disruption to the service.

[D15] means that if the Subscriber advertises too many routes to the SP or Operator, the SP or Operator might disregard some of them. This can lead to blackholing of some of the Subscriber's traffic, or other undesirable behavior. The SP or Operator can minimize disruption by disregarding the most recently received IPv6 Prefixes so as to maintain the paths that were previously working.

Note that the IPVC EP Maximum Number of IPv6 Routes Service Attribute limits the number of IPv6 routes at this IPVC EP, over the EI where the IPVC EP is located. This document also specifies a limit on the total number of IPv6 routes in the IPVC – see section 10.6.

It can be useful for the SP or Operator to notify the Subscriber or SP/SO (respectively) when the total number of IPv6 Prefixes that are associated with the IPVC EP is approaching the limit specified by the IPVC EP Maximum Number of IPv6 Routes Service Attribute, or has crossed it. The details of how this is done are outside the scope of this document.

- [D17] The SP or Operator **SHOULD** notify the Subscriber or SP/SO (respectively) when the total number of IPv6 Prefixes that are associated with the IPVC EP reaches the value of the IPVC EP Maximum Number of IPv6 Routes Service Attribute.
- [O14] The SP or Operator **MAY** notify the Subscriber or SP/SO (respectively) when the total number of IPv6 Prefixes that are associated with the IPVC EP is approaching the value of the IPVC EP Maximum Number of IPv6 Routes Service Attribute.

## 11.9 IPVC EP Ingress Class of Service Map Service Attribute

The IPVC EP Ingress Class of Service Map Service Attribute is a triple  $(F, M, D)$  where  $F$  is a list of one or more fields in the packet header that are used to determine the CoS Name,  $M$  is a mapping from combinations of values of those fields to CoS Names, and  $D$  is a default CoS Name used when the map cannot be applied. CoS Names are also known as “Traffic Classes”. The IPVC EP Ingress Class of Service Map is applied to Ingress IP Data Packets that are mapped to the IPVC

EP. The Cloud Ingress Class of Service Map defined in section 10.13.2 is applied to IP Data Packets received from a cloud service.

The possible values that can be included in list *F* are:

- *IP DS*
- *Source IP Address*
- *Destination IP Address*
- *L4 Protocol*
- *Source L4 Port*
- *Destination L4 Port*
- *Ethernet PCP*

Note: these values are applicable for IPVC EPs at UNIs and at ENNIs using Option A. Specification of the applicable values for an IPVC EP at an ENNI using Option B or Option C are deferred to a future version of this specification.

*Ethernet PCP* is only applicable at an ENNI using Option A.

**[R85]** The value of *F* in the IPVC EP Ingress Class of Service Map Service Attribute **MUST NOT** include *Ethernet PCP* unless the following conditions are met:

- The IPVC EP is at an ENNI using Option A; and
- All of the ENNI Links in the ENNI have a value for the ENNI Link L2 Technology Attribute (section 16.2) that indicates that VLAN Tagged Ethernet Frames are used to carry IP Packets across the ENNI.

Note that it is the responsibility of the LLO providing an Operator IP Service to ensure that [R85] is met, since the SP/SO using the service may not be aware of the details of the ENNI Links at the ENNI.

The map *M* is a set of (key, value) pairs where the key is a tuple containing possible values for the fields specified in list *F*, and the value is one of the CoS Names specified in the IPVC List of Class of Service Names Service Attribute (section 10.8). For example, if *F* contains only *IP DS*, then *M* comprises entries of the form (<DSCP value>, <CoS Name>), such as (10, “Voice”). Note that 10 is the DSCP value for DSCP Name ‘AF11’, so this entry would map traffic marked with AF11 to the “Voice” class. Another example: If *F* comprises *L4 Protocol* and *Destination L4 Port*, then *M* comprises entries of the form ((<L4 protocol>, <Port Number>), <CoS Name>), such as ((6, 22), “Interactive”). Note that 6 is the protocol number for TCP, and 22 is the TCP port number for SSH, so this entry would map SSH traffic to the “Interactive” class. Further examples can be found in Appendix B.5.

The value that is included in the key in map *M* for each field specified in list *F* is shown in Table 14.

Field in <i>F</i>	Values in the key in <i>M</i>
<i>IP DS</i>	DSCP value (integer from 0 to 63)
<i>Source IP Address</i>	IP Prefix
<i>Destination IP Address</i>	IP Prefix
<i>L4 Protocol</i>	Protocol Number (integer from 0 to 255)
<i>Source L4 Port</i>	Port Number (integer from 0 to 65535)
<i>Destination L4 Port</i>	Port Number (integer from 0 to 65535)
<i>Ethernet PCP</i>	PCP value (integer from 0 to 7)

**Table 14 – Values for the IPVC EP Ingress Class of Service Map**

Note that the IPVC EP Ingress Class of Service Map does not explicitly distinguish between the handling for IPv4 and IPv6 packets. However, different handling can be specified by including entries in the map that match on *Source IP Address* with the IP Prefix set to 0.0.0.0/0 or ::/0.

Note that the value of map *M* described here is an abstraction; it does not constrain how the map can be described in a protocol, database, service order form, etc. For example, shorthand descriptions such as using a range of port numbers are allowed, although this logically corresponds to a separate entry in map *M* for each port number in the description above.

The default CoS Name, *D*, is used when the map *M* cannot be applied to the packet, as described below.

- [R86] The CoS Names used in the map *M* and default *D* in the IPVC EP Ingress Class of Service Map Service Attribute **MUST** be present in the IPVC List of Class of Service Names (section 10.8) for the corresponding IPVC, or be the special value *Discard*.
- [R87] Ingress IP Data Packets that are mapped to the special CoS Name *Discard* **MUST** be discarded.

Table 15 below shows the criteria for whether an Ingress IP Data Packet matches an entry in map *M* if a given field is included in list *F*.

Field in <i>F</i>	Criteria for matching
<i>IP DS</i>	Value in the DS Field (as defined in RFC 3260 [22]) in the IP Data Packet matches the value in the key in map <i>M</i> .
<i>Source IP Address</i>	The Source Address in the IP Data Packet is within the IP Prefix in the key in map <i>M</i> , and there is no other matching entry in <i>M</i> that has a more specific IP Prefix.
<i>Destination IP Address</i>	The Destination Address in the IP Data Packet is within the IP Prefix in the key in map <i>M</i> , and there is no other matching entry in <i>M</i> that has a more specific IP Prefix.
<i>L4 Protocol</i>	The Protocol field in the IPv4 header of an IPv4 Data Packet, or the last “Next Header” field in an IPv6 Data Packet matches the value in the key in map <i>M</i> .
<i>Source L4 Port</i>	The IP Data Packet contains a TCP or UDP packet and the Source Port in the TCP or UDP header matches the value in the key in map <i>M</i> .
<i>Destination L4 Port</i>	The IP Data Packet contains a TCP or UDP packet and the Destination Port in the TCP or UDP header matches the value in the key in map <i>M</i> .
<i>Ethernet PCP</i>	The value in the PCP field in the outermost VLAN Tag of the VLAN Tagged Ethernet Frame containing the IP Data Packet matches the value in the key in map <i>M</i> .

**Table 15 – Matching Criteria for the IPVC EP Ingress Class of Service Map**

In the case of *L4 Protocol*, for an IPv6 Packet, the relevant field is the “Next Header” field in the IPv6 header, if it does not indicate an IPv6 extension header, otherwise the “Next Header” field in the last IPv6 extension header.

*When establishing a TCP connection to a server, the destination port is normally well known whereas the source port is typically chosen arbitrarily by the client. However, responses from the server to the client use the well known number as the source port, and the arbitrarily chosen number as the destination port. In this case, matching the source port can be useful.*

The criteria for matching the source or destination address allow for the case where map *M* contains entries with overlapping IP Prefixes (and the same values for any other fields). In this case, the entry with the most specific IP Prefix (i.e. the longest prefix length) is used (“longest prefix matching”). The following requirement ensures that when both source and destination addresses are matched, a single entry can be selected unambiguously.

- [R88] If list *F* contains both *Source IP Address* and *Destination IP Address*, map *M* **MUST NOT** contain any pair of entries in which the IP Prefixes for Source IP Address overlap, the IP Prefixes for Destination IP Address overlap, the IP Prefix for the Source Address is more specific in one entry and the IP Prefix for the Destination Address is more specific in the other entry.
- [R89] An Ingress IP Data Packet that matches an entry in map *M* as specified in Table 15, for the fields specified in list *F*, **MUST** be assigned the corresponding CoS Name from the map *M*.

- [R90]** An Ingress IP Data Packet that does not match any entry in map *M* as specified in Table 15, for the fields specified in list *F*, **MUST** be assigned the default CoS Name, *D*.

Note that the IPVC EP Ingress Class of Service Map is an IPVC EP attribute. This means that when there are multiple IPVC EPs at a given EI, the correct IPVC EP needs to be determined before the IPVC EP Ingress Class of Service Map can be applied and the CoS Name determined. As finding the correct IPVC EP can involve a routing lookup (see sections 9.3.1 and 11.5.1), this can be difficult to implement in some cases. However, if the IPVC EP Ingress Class of Service Map Service Attribute has the same value at all IPVC EPs at the EI, it is not necessary to find the IPVC EP before determining the CoS Name.

- [O15]** When there are multiple IPVC EPs at a given UNI, the SP or Operator **MAY** require that the value of the IPVC EP Ingress Class of Service Map Service Attribute is the same at all of the IPVC EPs.

*Note that the Ingress Class of Service Map is often implemented with an ACL or QoS marking policy; however, this specification does not mandate any particular implementation.*

## 11.10 IPVC EP Egress Class of Service Map Service Attribute

The IPVC EP Egress Class of Service Map is a pair of values (*D*, *P*). *D* specifies how to set the DS field in Egress IP Data Packets based on the CoS Name. It is either *None*, or a mapping from CoS Names to DSCP values. *P* specifies how to set the PCP field in VLAN Tagged Ethernet Frames containing Egress IP Data Packets based on the CoS Name. It is either *None*, or a mapping from CoS Names to PCP values. Note that the map only applies to Egress IP Data Packets; how to set the DSCP or PCP fields for Egress IP Control Protocol Packets that are generated within the SP or Operator Network is not specified.

If DSCP Preservation is enabled for the IPVC (see section 10.7), then the value of *D* is always *None*, since the DSCP value in an Egress IP Data Packet is required to be the same as that in the corresponding Ingress IP Data Packet. Otherwise, specifying a mapping as the value of *D* in the Egress Class of Service Map is optional at a UNI (i.e., a value of *None* is allowed), but is required at an ENNI (i.e. the value cannot be *None*).

- [R91]** If an IPVC has IPVC DSCP Preservation Service Attribute (section 10.7) set to *Enabled*, then each IPVC EP for that IPVC **MUST** have *D* in the IPVC EP Egress Class of Service Map set to *None*.
- [R92]** If an IPVC has IPVC DSCP Preservation Service Attribute (section 10.7) set to *Disabled*, then for each IPVC EP for that IPVC that is located at an ENNI using Option A, the value of *D* in the IPVC EP Egress Class of Service Map **MUST NOT** be *None*.

When a mapping is specified, it needs to map every CoS Name in the IPVC List of CoS Names to a DSCP value. This DSCP value is used in Egress IP Data Packets that were mapped to that CoS Name, as captured in the following requirements.

- [R93] If the value of *D* in the IPVC EP Egress Class of Service Map for an IPVC EP is not *None*, it **MUST** map each CoS Name in the IPVC List of CoS Names (section 10.8) for the IPVC that has the IPVC EP to a DSCP value.
- [R94] If the value of *D* in the IPVC EP Egress Class of Service Map for an IPVC EP is not *None*, an Egress IP Data Packet transmitted via that IPVC EP **MUST** have the value of the DS Field set to the DSCP value in map *D* in the IPVC EP Egress Class of Service Map that corresponds to the CoS Name assigned to the packet on ingress.

At an ENNI using Option A, where the ENNI Links use VLAN-tagged Ethernet Frames, a map can also be specified for the value of *P* in the IPVC EP Egress Class of Service Map. In all other cases, *P* is *None*. This is captured in the following requirement.

- [R95] The value of *P* in the IPVC EP Egress Class of Service Map Service Attribute **MUST** be *None* unless the following conditions are met:
- The IPVC EP is at an ENNI using Option A; and
  - All of the ENNI Links in the ENNI have a value for the ENNI Link L2 Technology Attribute (section 16.2) that indicates that VLAN Tagged Ethernet Frames are used to carry IP Packets across the ENNI.

Note that it is the responsibility of the LLO providing an Operator IP Service to ensure that [R95] is met, since the SP/SO using the service may not be aware of the details of the ENNI Links at the ENNI.

When a mapping is specified for *P*, it needs to map every CoS Name in the IPVC List of CoS Names to a PCP value. This PCP value is used in the outermost VLAN Tag in VLAN Tagged Ethernet Frames containing Egress IP Data Packets that were mapped to that CoS Name, as captured in the following requirements.

- [R96] If the value of *P* in the IPVC EP Egress Class of Service Map for an IPVC EP is not *None*, it **MUST** map each CoS Name in the IPVC List of CoS Names (section 10.8) for the IPVC that has the IPVC EP to a PCP value.
- [R97] If the value of *P* in the IPVC EP Egress Class of Service Map for an IPVC EP is not *None*, a VLAN Tagged Ethernet Frame containing an Egress IP Data Packet transmitted across the ENNI via that IPVC EP **MUST** have the value of the PCP field in the outermost VLAN tag set to the PCP value in map *P* in the IPVC EP Egress Class of Service Map that corresponds to the CoS Name assigned to the packet on ingress.

For example, if the IPVC List of CoS Names contains two CoS Names, ‘High’ and ‘Low’, the IPVC EP Egress Class of Service Map Service Attribute might have a value of *D* that maps ‘High’ to DSCP value 46 (EF) and ‘Low’ to DSCP value 0 (CS0), and set *P* to *None*. Further examples can be found in Appendix B.5.3.

Note that the IPVC EP Egress Class of Service Map can map multiple CoS Names to the same DSCP value and/or the same PCP value.

### 11.11 IPVC EP Ingress Bandwidth Profile Envelope Service Attribute

The IPVC EP Ingress Bandwidth Profile Envelope Service Attribute is either *None*, or a single Bandwidth Profile Envelope consisting of parameters and Bandwidth Profile Flow specifications, as described in section 17.3. If specified, the BWP Envelope is used for an ingress Bandwidth Profile.

An Ingress Bandwidth Profile Envelope can be specified for one of a UNI, a UNI Access Link, an ENNI Link, or an IPVC EP – this follows from [R104], [R176] and [R190].

Note that this document only describes the case where there is at most one IPVC EP with a given ENNI Service Mapping Context at an ENNI; therefore, there is no attribute for specifying an Ingress Bandwidth Profile Envelope for an ENNI Service Mapping Context at an ENNI, as this would be the same as specifying an Ingress Bandwidth Profile Envelope for the IPVC EP.

### 11.12 IPVC EP Egress Bandwidth Profile Envelope Service Attribute

The IPVC EP Egress Bandwidth Profile Envelope Service Attribute is either *None*, or a single Bandwidth Profile Envelope consisting of parameters and Bandwidth Profile Flow specifications, as described in section 17.3. If specified, the BWP Envelope is used for an egress Bandwidth Profile.

An Egress Bandwidth Profile Envelope can be specified for one of a UNI, a UNI Access Link, an ENNI Link, or an IPVC EP – this follows from [R106], [R177] and [R192].

Note that this document only describes the case where there is at most one IPVC EP with a given ENNI Service Mapping Context at an ENNI; therefore, there is no attribute for specifying an Egress Bandwidth Profile Envelope for an ENNI Service Mapping Context at an ENNI, as this would be the same as specifying an Egress Bandwidth Profile Envelope for the IPVC EP.

## 12 UNI Service Attributes

This section specifies the Service Attributes for IP Services that apply to each UNI. There is one instance of these attributes for each UNI supported by the SP or Operator. These attributes apply to UNIs for both Subscriber IP Services and Operator IP Services unless otherwise stated. In the case of a Subscriber IP Service, the Service Attributes are agreed between the Subscriber and an SP, and the SP has responsibility for delivering the service (i.e. most requirements are on the SP). In the case of an Operator IP Service, the Service Attributes are agreed between an SP/SO and an Operator, and the Operator has responsibility for delivering the service (i.e. most requirements are on the Operator). If an SP uses an Operator to reach a UNI, the values of the UNI Service Attributes that they agree with the Operator do not necessarily have to be the same as the values they have agreed with the Subscriber, although in many cases they will be. The attributes are summarized in Table 16 and described in more detail in the following subsections.

Attribute Name	Summary Description	Possible Values
UNI Identifier	Unique identifier for the UNI for management purposes.	Printable string that is unique across the SP's or Operator's network.
UNI Management Type	Indication of who manages the CE.	<i>Subscriber-Managed</i> or <i>Provider-Managed</i> .
UNI List of UNI Access Links	List of UNI Access Links in the UNI.	List of UNI Access Link identifiers.
UNI Ingress Bandwidth Profile Envelope	Bandwidth Profile Envelope used for an ingress Bandwidth Profile.	<i>None</i> or a set of parameters as specified in section 17.3.
UNI Egress Bandwidth Profile Envelope	Bandwidth Profile Envelope used for an egress Bandwidth Profile.	<i>None</i> or a set of parameters as specified in section 17.3.
UNI List of Control Protocols	Indication of IP Control Protocols that are not forwarded transparently by the SP.	See section 12.6.
UNI Routing Protocols	List of Routing Protocols used across the UNI.	See section 12.7.
UNI Reverse Path Forwarding	Indicates whether RPF checks are used by the SP at the UNI.	<i>Enabled</i> or <i>Disabled</i> .

**Table 16 – UNI Service Attributes**

### 12.1 UNI Identifier Service Attribute

The UNI Identifier is a unique string identifier for the UNI. For a Subscriber IP Service, it can be used by the Subscriber and the SP to identify the UNI to each other. For an Operator IP Service, it can be used by the SP/SO and the Operator to identify the UNI to each other.

- [R98] The UNI Identifier **MUST** consist only of ASCII characters in the range 32-126 inclusive.



- [R99] The length of the UNI Identifier **MUST** be less than or equal to 53 characters.
- [R100] The value of the UNI Identifier **MUST** be unique among all such identifiers for UNIs supported by the Service Provider or Operator.

## 12.2 UNI Management Type Service Attribute

The UNI Management Type is either *Subscriber-Managed* or *Provider-Managed*, and indicates whether the CE is the responsibility of the Subscriber or the Service Provider, as described in section 7.5. If the UNI Management Type is *Subscriber-Managed*, the CE is managed by the Subscriber, and the UNI Access Links correspond with the IP Attachment Circuits between the CE and the PE. If the UNI Management Type is *Provider-Managed*, the CE is managed (logically) by the SP, and the UNI Access Links correspond with the links from the CE to the devices within the Subscriber Network. In this latter case, the IP Attachment Circuits between the CE and the PE are internal to the SP Network and hence outside the scope of this document.

For an Operator IP Service, a value of *Provider-Managed* indicates that from the Subscriber's perspective, the CE is managed by the SP, but in practice it is managed by the Operator.

Subscriber-Managed and Provider-Managed CEs are illustrated in Figure 7 in section 7.5.

**Note: this specification uses the IETF definition of CE that is common parlance in the context of IP. With this definition, the CE is the equipment that is directly adjacent (at Layer 3) to the PE, regardless of who owns and manages it. This is different to the definition of Customer Edge used in other MEF specifications.**

## 12.3 UNI List of UNI Access Links Service Attribute

The UNI List of UNI Access Links Service Attribute is a list of UNI Access Link Identifiers (see section 13.1) for the UNI Access Links in this UNI. A UNI Access Link is an IP subnetwork corresponding to a distinct IP subnet (which might use both IPv4 and IPv6 addressing), and consisting of a single IP hop from a service perspective (i.e., there is no intermediate router that processes the IP Packets traversing the link (see section 7.3)).

- [R101] A UNI Access Link **MUST** belong to exactly one UNI.
- [R102] The UNI Access Links listed in the UNI List of UNI Access Links Service Attribute **MUST** all be connected to the same Subscriber Network.

## 12.4 UNI Ingress Bandwidth Profile Envelope Service Attribute

The UNI Ingress Bandwidth Profile Envelope Service Attribute is either *None*, or a single Bandwidth Profile Envelope consisting of parameters and Bandwidth Profile Flow specifications, as described in section 17.3. If specified, the BWP Envelope is used for an ingress Bandwidth Profile. Note that Bandwidth Profile Flows can be defined per UNI, per IPVC EP, per UNI Access Link, per CoS Name, etc. – see section 17.1.

At a UNI, an Ingress Bandwidth Profile Envelope can be specified for the UNI as a whole, or for a UNI Access Link, or an IPVC EP.

**[R103]** If the UNI Ingress Bandwidth Profile Envelope Service Attribute is not *None*, the UNI Access Link Ingress Bandwidth Profile Envelope Service Attribute (section 13.10) **MUST** be *None* for all UNI Access Links in the UNI.

**[R104]** If the UNI Ingress Bandwidth Profile Envelope Service Attribute is not *None*, the IPVC EP Ingress Bandwidth Profile Envelope Service Attribute (section 11.11) **MUST** be *None* for all IPVC EPs at the UNI.

## 12.5 UNI Egress Bandwidth Profile Envelope Service Attribute

The UNI Egress Bandwidth Profile Envelope Service Attribute is either *None*, or a single Bandwidth Profile Envelope consisting of parameters and Bandwidth Profile Flow specifications, as described in section 17.3. If specified, the BWP Envelope is used for an egress Bandwidth Profile. Note that Bandwidth Profile Flows can be defined per UNI, per IPVC EP, per UNI Access Link, per CoS Name, etc. – see section 17.1.

At a UNI, an Egress Bandwidth Profile Envelope can be specified for the UNI as a whole, or for a UNI Access Link, or an IPVC EP.

**[R105]** If the UNI Egress Bandwidth Profile Envelope Service Attribute is not *None*, the UNI Access Link Egress Bandwidth Profile Envelope Service Attribute (section 13.11) **MUST** be *None* for all UNI Access Links in the UNI.

**[R106]** If the UNI Egress Bandwidth Profile Envelope Service Attribute is not *None*, the IPVC EP Egress Bandwidth Profile Envelope Service Attribute (section 11.12) **MUST** be *None* for all IPVC EPs at the UNI.

## 12.6 UNI List of Control Protocols Service Attribute

The UNI List of Control Protocols Service Attribute is a list of control protocols, along with corresponding addressing and references, that identifies packets that are IP Control Protocol Packets rather than IP Data Packets. Each entry in the list consists of a 3-tuple containing the protocol name, addressing information (either *SP/Operator Addresses* or *Any*), and one or more references.

Any IP Packet matching an entry in the list is considered to be an IP Control Protocol Packet. Ingress IP Control Protocol Packets are not forwarded across the IPVC (i.e., the packet delivery requirements and packet transparency requirements in section 10.4 do not apply); they are either peered or discarded. Egress IP Control Protocol Packets are generated within the SP or Operator Network.

Some protocols can be used both between the SP and the Subscriber across a UNI, and by the Subscriber between different parts of the Subscriber Network; for example, a Subscriber might use BGP at a UNI to advertise routes to the SP, and also use BGP between their own routers in different sites to exchange other information. In such cases, the IP Packets that are intended to be peered

by the SP and the IP Packets that are intended to be carried over the IPVC and delivered to another UNI are typically distinguished by the source or destination IP address.

To accommodate this, each entry in the UNI List of Control Protocols contains addressing information that identifies which unicast addresses are matched when determining whether an IP Packet is an IP Control Protocol Packet. If the addressing information is *SP/Operator Addresses*, then Ingress IP Packets for the specified protocol that have a multicast or broadcast destination address, or a unicast destination address that is reachable within the SP’s or Operator’s network, are considered to be IP Control Protocol Packets, and Egress IP Packets for the specified protocol that have a source address that is reachable within the SP’s or Operator’s network are considered to be IP Control Protocol Packets. If the addressing information is *Any*, then all IP Packets for the specified protocol that cross the UNI are considered to be IP Control Protocol Packets.

For an Operator IP Service, a value of *SP/Operator Addresses* indicates that the Operator at the UNI needs to treat Ingress IP Packets for the specified protocol that have a unicast destination address that is reachable within their own network as IP Control Protocol Packets (and likewise treat Egress IP Packets for the specified protocol that have a source address that is reachable within their own network as IP Control Protocol Packets. Note that an Ingress IP Packet received by an Operator at a UNI might have a unicast destination address that is not reachable within the Operator’s Network, but is reachable within the rest of the SP’s network (e.g. reachable on the other side on an ENNI). In this case, the Operator treats the packet as an IP Data Packet and will forward it over the ENNI, but the SP or another Operator on the other side of the ENNI might peer or discard it.

Delivery of multicast Ingress IP Packets across the IPVC is outside the scope of this specification (and could be addressed in a future version); hence all multicast IP Packets for the specified protocols are considered to be IP Control Protocol Packets regardless of the specified addressing information.

Any IP Packets that cross the UNI that are not considered to be IP Control Protocol Packets are IP Data Packets, and hence the packet delivery and packet transparency requirements in section 10.4 apply.

Each entry in the UNI List of Control Protocols includes a reference to a standard or other specification that describes how packets belonging to the protocol are identified.

An example of the UNI List of Control Protocols Service Attribute for a Subscriber IP Service is shown in Table 17.

Protocol	Addressing	Reference
ICMP	SP/Operator Addresses	IETF RFC 792
BGP	SP/Operator Addresses	IETF RFC 4271
OSPF	Any	IETF RFC 2328 and RFC 5340

**Table 17 – Example value of the UNI List of Control Protocols Service Attribute**

In this example, BGP is used at the UNI, and the SP also allows the Subscriber to ping their internal addresses with ICMP. OSPF is also listed because the SP wants to explicitly filter (discard) all OSPF packets. All other protocols are delivered across the IPVC as data packets.

Another example is shown in Table 18.

Protocol	Addressing	Reference
OSPF	Any	IETF RFC 2328 and IETF RFC 5340
DHCP (IPv4)	Any	IETF RFC 2131 and IETF RFC 2132
BFD	Any	IETF RFC 5880 and IETF RFC 5881
SLAAC	Any	IETF RFC 4862
IGMP	Any	IETF RFC 3376
MLD	Any	IETF RFC 3810

**Table 18 – Example value of the UNI List of Control Protocols Service Attribute**

In this example, OSPF, DHCP (for IPv4), SLAAC (for IPv6) and BFD are used at the UNI. IGMP and MLD are also listed because the SP wants to explicitly filter (discard) all IGMP and MLD packets. All other protocols are delivered across the IPVC as data packets.

As described above, packets relating to a protocol that is not included in the UNI List of Control Protocols Service Attribute at a given UNI are considered to be IP Data Packets.

Note that although multicast routing is outside the scope of this specification, control protocols related to multicast routing (e.g. IGMP, MLD, and PIM) can be included in the list of control protocols. This can be useful if the SP wishes to discard all IP Packets relating to such protocols, to ensure they do not disrupt the operation of the SP Network.

**[R107]** An Ingress IP Packet that matches an entry in the UNI List of Control Protocols Service Attribute **MUST NOT** be delivered as an Egress IP Packet at any EI.

Note that if a protocol is peered, an Ingress IP Packet might result in a different IP Packet being sent in response. [R107] means that an Ingress IP Packet cannot result in an unmodified (other than as described in section 9.4) Egress IP Packet.

**[O16]** IP Control Protocol Packets **MAY** be peered or discarded by the SP or Operator.

Whether a protocol is peered or discarded is at the discretion of the SP or Operator; but some protocols have to be peered if they correspond with Service Attributes that have been agreed.

**[R108]** The following protocols **MUST** be included in the UNI List of Control Protocols if they are enabled per the corresponding Service Attributes as shown below:

- OSPF: UNI Routing Protocols Service Attribute (section 12.7).
- BGP: UNI Routing Protocols Service Attribute (section 12.7).

- BFD: UNI Access Link BFD Service Attribute (section 13.8) for any UNI Access Link in the UNI.
- DHCP (IPv4): UNI Access Link IPv4 Connection Addressing Service Attribute (section 13.4) for any UNI Access Link in the UNI.
- DHCP (IPv6): UNI Access Link IPv6 Connection Addressing Service Attribute (section 13.5) for any UNI Access Link in the UNI.
- DHCP (IPv4 and/or IPv6): UNI Access Link DHCP Relay Service Attribute (section 13.6) for any UNI Access Link in the UNI.
- DHCP (IPv6): UNI Access Link Prefix Delegation Service Attribute for any UNI Access Link in the UNI.
- ICMP: IPVC Path MTU Discovery Service Attribute (section 10.11) for any IPVC attached to the UNI.

Note that for certain protocols, such as OSPF, it does not make sense to deliver protocol packets over the IPVC even if the protocol is not enabled at a UNI. This can be prevented by including such protocols in the value of the UNI List of Control Protocols Service Attribute.

For convenience, references for some common IP Control Protocols are given in Table 19 – these might or might not be included in the UNI List of Control Protocols for a given UNI. Note that this is not an exhaustive list; other IP Control Protocols can be included in the UNI List of Control Protocols.

Protocol	Reference
BGP	RFC 4271 [29]
OSPF	RFC 2328 [10] and RFC 5340 [36]
RIP	RFC 2453 [13]
BFD	RFC 5880 [44] and RFC 5881 [45]
ICMP	RFC 792 [2] and RFC 4443 [32]
IGMP	RFC 3376 [23]
MLD	RFC 3810 [26]
PIM	RFC 7761 [53] and RFC 3973 [28]
DHCP (IPv4)	RFC 2131 [8] and RFC 2132 [9]
DHCP (IPv6)	RFC 8415 [60]
SLAAC	RFC 4862 [35]
...	...

**Table 19 – Examples of IP Control Protocols**

The value of the UNI List of Control Protocols Service Attribute might include none, some or all of the protocols listed in Table 19, and might include other IP protocols not listed in Table 19.

## 12.7 UNI Routing Protocols Service Attribute

The UNI Routing Protocols Service Attribute specifies the routing protocols and associated parameters that are used to exchange IP routes across the UNI. The value is a list of protocols (possibly empty), where each entry consists of the protocol name (one of *Static*, *OSPF* or *BGP*), the

type of routes that will be exchanged (one of *IPv4*, *IPv6* or *Both*), and a set of additional parameters as specified in the subsections below.

- [R109]** The value of the UNI Routing Protocols Service Attribute **MUST NOT** contain more than one entry for the same protocol name, except when there are exactly two entries with a given protocol name, one with route type *IPv4* and one with route type *IPv6*.

Note that regardless of the routing protocol in use, the SP or Operator directs traffic destined for an address within the IP Prefixes identified by the UNI Access Link IPv4 Connection Addressing Service Attribute (see section 13.4) and the UNI Access Link IPv6 Connection Addressing Service Attribute (see section 13.5) towards the corresponding UNI Access Link, as described in section 9.

The UNI Routing Protocols Service Attribute applies to all UNI Access Links in a UNI. If there are multiple UNI Access Links connecting the SP or Operator to a given part of the Subscriber Network, and it is desired to use different routing protocols or parameters on different UNI Access Links, the UNI Access Links can be assigned to different UNIs, as described in section 7.3.

When all of the end hosts in the Subscriber Network that are reachable at a given UNI are directly adjacent (at Layer 3) to the UNI Access Links in that UNI (i.e. there is no router on the Subscriber's side of the UNI), and therefore only use IP addresses within the IP Prefixes identified by the UNI Access Link IPv4 Connection Addressing Service Attribute (see section 13.4) and the UNI Access Link IPv6 Connection Addressing Service Attribute (see section 13.5), there is no need to specify any additional routing information (static routing or dynamic routing protocols). This is likely only useful when the UNI contains a single UNI Access Link. In that case, the Subscriber can use a "default gateway", i.e. a default route towards the single UNI Access Link. As above, the SP or Operator directs traffic that is destined for an IP address within the IP Prefix identified by the connection addressing attributes towards the UNI Access Link.

Each of the routing protocols specified below has a parameter for setting the administrative distance. This is a numeric metric used to control which routes are selected, when there are multiple routes for the same IP Prefix. A lower number indicates a more preferable route. For the purpose of this specification, IP Prefixes identified by the UNI Access Link IPv4 Connection Addressing Service Attribute (see section 13.4) and the UNI Access Link IPv6 Connection Addressing Service Attribute (see section 13.5) are considered to have administrative distance of 0, and for an IPVC EP at a given UNI, routes towards other IPVC EPs for the IPVC are considered to have administrative distance 200.

- [R110]** When selecting the best route for packet delivery as described in section 9, the SP or Operator **MUST** prefer routes with a lower administrative distance.

Note that the administrative distance values used in this document and specified in the value of the UNI Routing Protocols Service Attribute are only related to each other, to specify the relative preference of routes. They might or might not correspond with administrative distance values actually used in the SP's or Operator's devices to implement the behavior.

For BGP and OSPF, setting a different administrative distance for different IP Prefixes is not supported in this version of the specification.

Examples showing the value of the UNI Routing Protocols Service Attribute can be found in Appendix C.

### 12.7.1 Static

When an entry in the UNI Routing Protocols list is for *Static*, the IP Prefixes used in the Subscriber Network that are reachable via this UNI are specified as additional parameters in the entry. These are known as Static IP Prefixes. For each Static IP Prefix, the following information is also specified:

- Forwarding information, consisting of either a nexthop IP address in the Subscriber Network (if the access medium is multipoint capable, e.g. Ethernet), or a specific UNI Access Link (if the access medium is strictly point-to-point, e.g. HDLC, PPP over DSL).
- Administrative Distance, an integer greater than 0.

The SP or Operator directs traffic destined for an address within any of the Static IP Prefixes towards the UNI, using the nexthop address or UNI Access Link specified for that IP Prefix. The Subscriber routes traffic towards the UNI Access Links that make up the UNI (e.g. by using a default or aggregate route).

The same IP Prefix can be specified more than once in the list of Static IP Prefixes, if it has different forwarding information.

If a static prefix is specified with a nexthop address that is not reachable over this UNI, or with a UNI Access Link that is non-operational, the static route is considered inactive and hence is not used by the SP or Operator for directing traffic. In particular, the static route is not used if the specified nexthop can only be reached via a different UNI.

*Note that if the UNI consists of point-to-point UNI Access Links on a multipoint-capable medium (e.g., Ethernet), the specified nexthop is likely to be the Subscriber Address specified as part of the UNI Access Link IPv4 Connection Addressing Service Attribute (see section 13.4) or the UNI Access Link IPv6 Connection Addressing Service Attribute (see section 13.5) for one of the UNI Access Links.*

Note: if a Static IP Prefix is specified that matches the IP Prefix for the connection addresses on one of the UNI Access Links (see sections 13.4 and 13.5), the connected route is always preferred as it has administrative distance fixed to 0.

### 12.7.2 OSPF

When an entry in the UNI Routing Protocols is for *OSPF*, OSPF as specified in RFC 2328 [10] (for IPv4) and/or RFC 5340 [36] (for IPv6) is used across each UNI Access Link to exchange routing information. The Subscriber uses OSPF to advertise IP Prefixes used within the Subscriber Network, that are reachable via the UNI Access Link, to the SP or Operator, which consequently directs traffic destined for any IP address within those IP Prefixes towards the UNI Access Link(s) over which the IP Prefixes were advertised. The SP or Operator uses OSPF to advertise IP Prefixes

that are reachable via other EIs that the IPVC is attached to, so that the Subscriber can direct traffic towards those IP Prefixes over the corresponding UNI Access Links.

The additional parameters that need to be agreed when OSPF is used are:

- Area ID (0 – 4294967295, normally expressed as an IPv4 address).
- Area type (*Normal*, *Stub* or *NSSA*).
- Authentication Type (*None*, *Password* or *Message Digest*).
- Hello Interval (0 – 65535, in seconds).
- Dead Interval (0 – 4294967295, in seconds).
- Retransmit Interval (integer greater than 0, in seconds).
- Administrative Distance (integer greater than 0).

The Area ID is a 32 bit number (typically written as an IPv4 address) that specifies the OSPF Area.

If the Area ID is 0 (0.0.0.0), the area is the OSPF Backbone area. This can be used at the UNI, for example, if the Subscriber wishes for the Service Provider to implement a “super backbone” configuration, which allows the remote networks to appear to be in the same OSPF Backbone Area (Area ID 0), preserving the Subscriber’s route types. If a “super-backbone” is not used, the Subscriber’s routes from the remote locations will be learned as external, which can affect the routing within the Subscriber Network.

The Area Type indicates the type of OSPF Area. An Area Type of *Normal* means the area is not a stub or NSSA (see RFC 3101 [20]) area.

The Authentication Type indicates the type of authentication used for OSPF adjacencies. Similarly, the Hello Interval, Dead Interval and Retransmit Interval specify the various timers that are used to create OSPF adjacencies.

The Administrative Distance is an integer greater than 0, and is applied by the SP or Operator to all IP Prefixes advertised by the Subscriber over the UNI using OSPF.

Note: parameters, behavior and requirements relating to the use of OSPF Sham links, and further parameters relating to authentication, are deferred to a future version of this specification.

### 12.7.3 BGP

When an entry in the UNI Routing Protocols is for *BGP*, BGP as specified in RFC 4271 [29] is used across the UNI to exchange routing information. The Subscriber uses BGP to advertise IP Prefixes used within the Subscriber Network that are reachable over the UNI to the SP or Operator, which consequently directs traffic destined for any IP address within those IP Prefixes towards the UNI Access Link(s) corresponding to the nexthop associated with the IP Prefix. The SP or Operator uses BGP to advertise IP Prefixes that are reachable via other EIs that the IPVC is attached to the Subscriber, so that the Subscriber can direct traffic destined for those IP Prefixes towards the SP or Operator, over the UNI Access Link(s) corresponding to the nexthop associated with the IP Prefix.

The additional parameters that need to be agreed when BGP is used are:



- Subscriber's AS Number.
- Peer's AS Number.
- Connection Address Family (*IPv4* or *IPv6*).
- Peering Addresses (*Connection Addresses*, or *Loopbacks* plus a list of pairs of IP addresses).
- Authentication (*None* or *MD5* plus a password).
- BGP Community List (see below).
- BGP Extended Community List (see below).
- Hold Time (time in seconds).
- Damping (*None* or a set of damping parameters).
- AS Override (*Enabled* or *Disabled*).
- Administrative Distance (integer greater than 0).

The Subscriber's and Peer's AS Numbers are used to establish BGP peerings. The Peer's AS Number could be the SP's AS Number, or an Operator's AS Number. In particular, if the SP uses another Operator to reach a UNI, the value of the "Peer's AS Number" that the SP agrees with the Subscriber will likely be the Operator's AS number, rather than their own, since this is the value the Subscriber needs to use to establish a BGP peering.

BGP can be run over the UNI in two ways: either a separate BGP session can be established over each UNI Access Link, or one or more BGP sessions can be established over the UNI as a whole. In the latter case, each session is typically established between locally assigned "loopback" addresses on the Subscriber's and SP's or Operator's routers, and the reachability of these loopback addresses is established by other means (e.g. using static routing or OSPF).

If the Peering Addresses parameter is *Connection Addresses*, a separate BGP peering session is established over each UNI Access Link, using the primary IPv4 addresses in the UNI Access Link IPv4 Connection Addressing Service Attribute (section 13.4) or the first IPv6 addresses in the UNI Access Link IPv6 Connection Addressing Service Attribute (section 13.5), as indicated by the Connection Address Family parameter. These peering sessions are single-hop eBGP connections. Note in this case that the same values for the parameters above apply to each of these BGP peering sessions; if this is not desired, the UNI Access Links can be assigned to different UNIs.

If the Peering Addresses parameter is *Loopbacks*, a list of pairs of IP addresses is additionally specified, each pair containing the Subscriber's loopback address and the SP's or Operator's loopback address. A single BGP peering session is established for each pair of addresses. These peering sessions are multihop eBGP connections. Again, the same values for the parameters above apply to all of the BGP peering sessions.

**[R111]** If an entry in the UNI Routing Protocols list for *BGP* has Connection Address Family set to *IPv4* and Peering Addresses set to *Connection Addresses*, the UNI Access Link IPv4 Connection Addressing Service Attribute (section 13.4) **MUST** be *Static* with a Primary Subnet Subscriber IPv4 Address specified, at every UNI Access Link in the UNI.

**[R112]** If an entry in the UNI Routing Protocols list for *BGP* has Connection Address Family set to *IPv6* and Peering Addresses set to *Connection Addresses*, the UNI

Access Link IPv6 Connection Addressing Service Attribute (section 13.5) **MUST** be *Static* with a Subscriber IPv6 Address specified, at every UNI Access Link in the UNI.

- [R113]** If an entry in the UNI Routing Protocols list for *BGP* has Peering Addresses set to *Loopbacks*, the IP addresses specified **MUST** be for the address family specified in the Connection Address Family parameter.

When a BGP session is established using loopback addresses, the SP and the Subscriber each need to know how to reach the other's loopback addresses. If OSPF is used across the UNI as well as BGP (as described in section 12.7.2), for the appropriate address family, then this can be used to advertise the reachability of the loopback addresses. Alternatively, a *Static* entry can be used (as described in section 12.7.1) to provide the reachability of the Subscriber's loopback address to the SP, and the Subscriber can assume that the SP's loopback address can be reached over any operational UNI Access Link, and install their own local routes accordingly. If the SP uses an Operator to reach the UNI, the same mechanisms can be used; for example, a *Static* entry can be used by the SP to provide the reachability of the Subscriber's loopback address to the Operator.

- [R114]** For a Subscriber IP Service, when an entry in the UNI Routing Protocols is for *BGP*, the SP and the Subscriber **MUST** support 4-octet AS Numbers as described in RFC 6793 [47].
- [R115]** For an Operator IP Service, when an entry in the UNI Routing Protocols is for *BGP*, the SP/SO and the Operator **MUST** support 4-octet AS Numbers as described in RFC 6793 [47].
- [R116]** When an entry in the UNI Routing Protocols is for *BGP*, if the Authentication parameter is *MD5*, authentication using MD5 **MUST** be used as described in RFC 4271 [29] using the specified password.

Note that RFC 4271 [29] mandates support for MD5 passwords in BGP implementations.

The SP or Operator can configure BGP to wait passively for the Subscriber's devices to connect to it; this is helpful if it is not known whether the Subscriber devices are available yet. To ensure this works, the Subscriber has to use active mode.

- [R117]** The Subscriber **MUST NOT** use passive TCP establishment for BGP sessions with the SP.

BGP Communities and Extended Communities allow additional metadata to be attached to route advertisements. Except in the case of the few standardized well-known values, this additional metadata has no intrinsic meaning. However, it is common for SPs to define a set of Communities or Extended Communities with associated semantics, that the Subscriber can attach to their route advertisements in order to affect how they are handled by the SP. If the SP uses an Operator IP Service to reach the UNI, the set of Communities or Extended Communities they agree with the Subscriber will typically be those defined by the Operator, rather than their own.

- [R118]** Each entry in the BGP Community List and BGP Extended Community List parameters **MUST** have an associated semantic that describes how the SP or Operator will handle routes advertised with that value.

The Hold Time parameter indicates the agreed Hold Time used for the BGP sessions. The possible values are 0 or an integer in the range 3 – 65535, as defined in RFC 4271 [29].

The SP or Operator can apply route flap damping to advertisements from the Subscriber, but in this case the parameters have to be agreed.

- [R119]** When the Damping parameter is not *None*, the SP or Operator **MUST** apply route flap damping as described in RFC 2439 [12].
- [R120]** When the Damping parameter is not *None*, a single set of parameters as described in section 4.2 of RFC 2439 [12] **MUST** be agreed.
- [R121]** When the Damping parameter is *None*, the SP or Operator **MUST NOT** apply route flap damping.

In cases where the Subscriber uses the same AS number in different parts of the Subscriber Network, it is necessary to tweak the normal handling of AS Paths in routes advertised to the Subscriber at each UNI, so as to prevent the routes being discarded due to BGP's loop prevention mechanisms. Two mechanisms are commonly used for this:

- The Subscriber can configure their BGP routers so as to disable the loop prevention mechanism in the case where their own AS Number appears in the AS Path (this is commonly known as "Allow-AS-in"). In this case, the SP does not need to be aware that this is being done and hence no parameters need to be agreed.
- The SP (or Operator) can overwrite instances of the Subscriber's AS Number in the AS Path with their own AS Number, when advertising routes to the Subscriber (this is commonly known as "AS Override"). This needs to be explicitly agreed between the SP and the Subscriber, and/or between an SP/SO and an Operator.

- [R122]** When the AS Override parameter is *Enabled*, the SP or Operator **MUST** overwrite all instances of the Subscriber's AS Number in the AS Path with their own AS Number, in routes advertised to the Subscriber.

The Administrative Distance is an integer greater than 0, and is applied by the SP or Operator to all IP Prefixes advertised by the Subscriber over the UNI using BGP.

## 12.8 UNI Reverse Path Forwarding Service Attribute

The UNI Reverse Path Forwarding Service Attribute takes the values *Enabled* or *Disabled* and indicates whether Reverse Path Forwarding (RPF) checks are used at the UNI by the SP or Operator. The Service Provider or Operator might want to use RPF checks when an Ingress IP Packet is received at a UNI, to prevent Denial of Service attacks.

- [R123]** If the UNI Reverse Path Forwarding Service Attribute is *Enabled*, when an Ingress IP Data Packet is received at the UNI, the Service Provider or Operator **MUST** use Reverse Path Forwarding checks as described in RFC 3704 [25], and discard the IP Packet if the checks fail.
- [R124]** If the UNI Reverse Path Forwarding Service Attribute is *Disabled*, when an Ingress IP Data Packet is received at the UNI, the Service Provider or Operator **MUST NOT** discard the IP Packet due to Reverse Path Forwarding checks as described in RFC 3704 [25].

### 13 UNI Access Link Service Attributes

This section specifies the Service Attributes for IP Services that apply to each UNI Access Link. There is one instance of these attributes for each UNI Access Link supported by the SP or Operator. These attributes apply to UNI Access Links for both Subscriber IP Services and Operator IP Services unless otherwise stated. In the case of a Subscriber IP Service, the Service Attributes are agreed between the Subscriber and an SP, and the SP has responsibility for delivering the service (i.e. most requirements are on the SP). In the case of an Operator IP Service, the Service Attributes are agreed between an SP/SO and an Operator, and the Operator has responsibility for delivering the service (i.e. most requirements are on the Operator). If an SP uses an Operator to reach a UNI, the values of the UNI Access Link Service Attributes that they agree with the Operator do not necessarily have to be the same as the values they have agreed with the Subscriber, although in many cases they will be. The attributes are summarized in Table 20 and described in more detail in the following subsections.

Attribute Name	Summary Description	Possible Values
UNI Access Link Identifier	Unique identifier for the UNI Access Link for management purposes.	Printable string that is unique across the SP's or Operator's network.
UNI Access Link Connection Type	Indicates whether the UNI Access Link is point-to-point or multipoint.	<i>P2P</i> or <i>Multipoint</i> .
UNI Access Link L2 Technology	Describes the underlying L2 technology for the UNI Access Link.	See section 13.3.
UNI Access Link IPv4 Connection Addressing	IPv4 Connection Addressing.	<i>None</i> , <i>Static</i> , <i>DHCP</i> or <i>Un-numbered</i> plus associated parameters.
UNI Access Link IPv6 Connection Addressing	IPv6 Connection Addressing.	<i>None</i> , <i>Static</i> , <i>DHCP</i> , <i>SLAAC</i> or <i>LL-only</i> plus associated parameters.
UNI Access Link DHCP Relay	Indicates whether DHCP Relay functionality is enabled.	<i>Disabled</i> , or an IPVC EP Identifier and a non-empty list of the Subscriber's DHCP servers.
UNI Access Link Prefix Delegation	Indicates whether DHCP Prefix delegation is enabled.	<i>Enabled</i> or <i>Disabled</i> .
UNI Access Link BFD	Indication of whether BFD is used on the UNI Access Link.	<i>None</i> , or a set of parameters as described in section 13.8.
UNI Access Link IP MTU	Maximum size, in octets, of an IP Packet that can traverse the UNI Access Link.	Integer $\geq 576$ .
UNI Access Link Ingress Bandwidth Profile Envelope	Ingress Bandwidth Profile Envelope for the UNI Access Link.	<i>None</i> or a set of parameters as described in section 17.3.
UNI Access Link Egress Bandwidth Profile Envelope	Egress Bandwidth Profile Envelope for the UNI Access Link.	<i>None</i> or a set of parameters as described in section 17.3.

Attribute Name	Summary Description	Possible Values
UNI Access Link Reserved VRIDs Service Attribute	List of VRRP VRIDs reserved for use by the SP or Operator.	List of integers (possibly empty), each between 1 and 255.

**Table 20 – UNI Access Link Service Attributes**

### 13.1 UNI Access Link Identifier Service Attribute

The UNI Access Link Identifier is a unique string identifier for the UNI Access Link. For a Subscriber IP Service, it can be used by the Subscriber and the SP to identify the UNI Access Link to each other. For an Operator IP Service, it can be used by the SP/SO and the Operator to identify the UNI Access Link to each other.

- [R125] The UNI Access Link Identifier **MUST** consist only of ASCII characters in the range 32-126 inclusive.
- [R126] The length of the UNI Access Link Identifier **MUST** be less than or equal to 53 characters.
- [R127] The value of the UNI Access Link Identifier **MUST** be unique among all such identifiers for UNI Access Links supported by the Service Provider or Operator.

### 13.2 UNI Access Link Connection Type Service Attribute

The UNI Access Link Connection Type is either *P2P* or *Multipoint*, and indicates the number of interfaces that can be attached to the UNI Access Link.

If the UNI Access Link Connection Type is *P2P*, this indicates that the link is logically point to point; that is, it provides an L3 link between, conceptually, a single Subscriber interface and a single SP or Operator interface. Note that in some cases, there can in fact be multiple interfaces, potentially on different devices (especially in the SP or Operator) that behave as if they were a single interface at L3, and in particular share a single IP address, for example by using VRRP (see section 13.3.4).

If the UNI Access Link Connection Type is *Multipoint*, this indicates that the link is multipoint; that is, it provides L2 connectivity between multiple L3 interfaces and in particular, allows multiple Subscriber devices or multiple SP or Operator devices to connect to each other over the same IP subnet (i.e. over a single IP hop). This is only possible if the underlying L2 connectivity is capable of multipoint, for example an Ethernet LAN using bridges, repeaters or wireless access points. Note that if traffic from multiple devices or interfaces is separated at L2, for example using Ethernet VLANs, this does not constitute a multipoint UNI Access Link; instead it is considered to be a number of separate UNI Access Links that happen to share the same physical media (an example is shown in appendix B.1).

*A UNI can contain more than one UNI Access Link with type Multipoint; one example would be where the UNI Access Links are WiFi networks with different Service Set Identifiers (SSIDs). This*

*might be useful, for example, in an enterprise Internet access service, where multiple SSIDs are used to control access for different groups of users.*

### 13.3 UNI Access Link L2 Technology Service Attribute

The UNI Access Link L2 Technology Service Attribute describes the underlying network layers that carry IP Packets across the UNI. The fundamental property of a UNI Access Link is to be able to convey IP Packets between the Subscriber and the SP or Operator; however, there are many possible ways to do this, and hence the details of this attribute are beyond the scope of this document. Nevertheless some examples are given below.

The details of the immediately-lower network layer always need to be agreed and hence specified in this Service Attribute. The number of other layers that need to be specified depends on the scenario; for example if the SP supplies a physical connection to the Subscriber, then the details of the physical layer (L1) and the datalink layer (L2) need to be specified. Conversely, if the SP and the Subscriber connect using an IP-Sec tunnel over the public Internet, then the details of the IP-Sec tunnel need to be agreed, but the details of how the SP connects to the Internet and how the Subscriber connects to the Internet do not need to be agreed or specified as part of this attribute.

If the SP uses an Operator IP Service to reach the UNI, then whatever information they agree with the Subscriber also needs to be agreed with the Operator.

In general, sufficient parameters need to be specified to describe the responsibility of the SP as viewed by the Subscriber. Anything which is entirely within the SP's (or Operator's) domain and is not visible to the Subscriber does not need to be specified. For example, if the SP provides a physical Ethernet link, then the attributes of the link need to be specified, but what is connected to the SP's (or Operator's) end of the link does not. The SP or Operator could connect their PE directly to the physical Ethernet connection, or they might carry the IP Packets over an intervening Ethernet access network before they reach the PE. As this is opaque to the Subscriber, it does not need to be specified.

Either the immediately-lower L2 layer, or some even lower layer, might provide resiliency over some or all of the UNI Access Link. For example, if the L2 Technology is Ethernet, the Virtual Router Redundancy Protocol (VRRP, as defined in RFC 5798 [43]) can be used to attach redundant devices to the UNI and have them behave, at the IP layer, as if they were a single device. Such resiliency mechanisms are opaque at the IP layer; for example, if the SP or Operator uses VRRP on the UNI Access Link, the Subscriber does not need to be aware of it (although they might be able to detect it), unless they also use VRRP (see section 13.12). Therefore, the use of such techniques does not need to be specified as part of this attribute.

The subsections below give some more detailed examples of the UNI Access Link L2 Technology. It is stressed that this set of examples is not in any way exhaustive. In particular, the L2 Technology is not restricted to Ethernet – other examples include ATM, PPP (over ISDN, or SDH), HDLC over SDH, PPPoE, etc.

### 13.3.1 Physical Point-to-Point Ethernet Link

One of the simplest cases is where the SP provides a single physical point-to-point Ethernet connection to the Subscriber, over which IP Packets are carried. No VLANs are used.

In this case, the L2 Technology would be Ethernet, and no additional L2 parameters are needed. However some additional L2 parameters can be agreed if desired, for example Ethernet OAM protocols could be agreed to be used.

The only lower layer in this case is the physical layer, and here the type of Ethernet PHY needs to be specified, along with any other physical layer attributes such as auto-negotiation and the type of optical fiber.

### 13.3.2 Multipoint Ethernet Link over WiFi

It is possible that the UNI Access Link is a multipoint link, as described in section 13.2. One common case is for residential Internet access services, where the SP supplies a CPE device that contains an Ethernet switch and WiFi access point, along with a Cable or DSL modem. If this is a Provider-managed CE, then the UNI Access Link is the multipoint Ethernet LAN comprising the switch ports and WiFi.

The L2 Technology in this case is Ethernet, and it is unlikely that any additional L2 parameters are needed. The lower layer comprises the physical Ethernet ports, where the type of Ethernet PHY would need to be specified, and the WiFi access point, where the supported WiFi standards (i.e. 802.11a/b/g/n) and the authentication details would need to be specified.

### 13.3.3 VLAN over an Ethernet Link Aggregation Group

A more complex example, for the purpose of illustration, is where the UNI Access Link is an Ethernet VLAN over a set of physical Ethernet interfaces forming a Link Aggregation Group (LAG). Note that although there are multiple physical interfaces in this case, this is a single UNI Access Link because the use of LAG makes it appear as a single connection at Layer 2, and hence also at Layer 3. Note also that the LAG only exists at the UNI, i.e. at the demarcation point of responsibilities. On the SP side, the LAG might connect to an Ethernet access network which carries traffic to the PE; the LAG is only the first Ethernet hop, so the PE would be unaware of it.

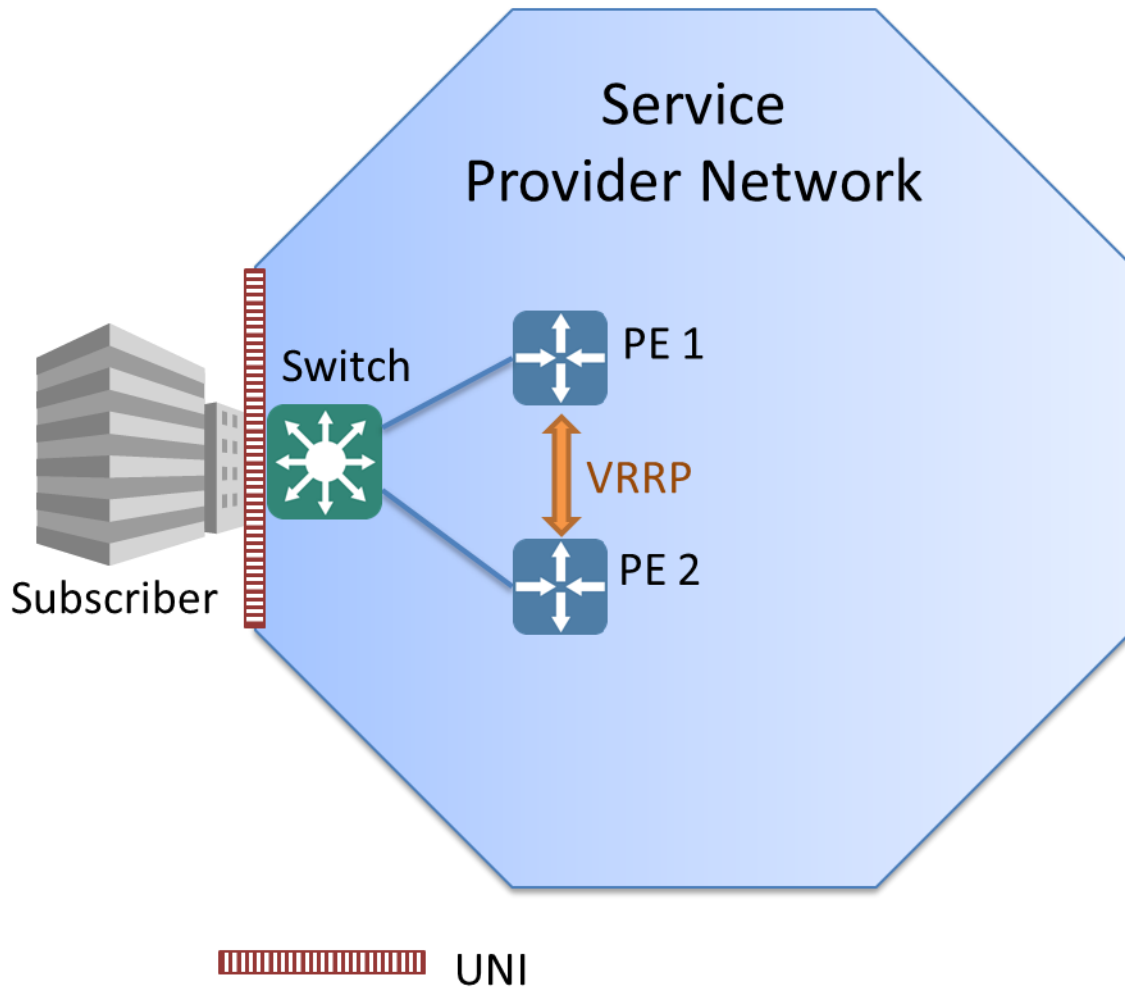
In this case, the L2 Technology is again Ethernet, and the VLAN type (C-VLAN or S-VLAN) as well as the VLAN ID for this UNI Access Link need to be agreed. Note that other VLAN IDs can be used on the same link, for other UNI Access Links or for non-IP services.

There are two lower layers here, i.e. the LAG and the underlying physical interfaces. Certain details might need to be specified for the LAG, for example the number of links or the use of LACP. The physical layer details also need to be agreed for each underlying physical interface.

### 13.3.4 Physical Ethernet Link using VRRP

A common scenario for Subscriber-managed CEs is for the SP or Operator to provide PE redundancy using a mechanism such as Virtual Router Redundancy Protocol (VRRP, see RFC 5798 [43]). An example is shown in Figure 28 below.





**Figure 28 – UNI Access Link using VRRP**

Using VRRP, the PEs conspire so as to appear as if there is a single PE; they share a single IP address and when one fails, the other takes over. This is mostly transparent to the CE, and hence the use of VRRP or similar mechanisms does not need to be agreed with the Subscriber (although the VRIDs may need to be reserved to avoid conflict with the Subscriber’s own use of VRRP, see section 13.12). The UNI Access Link in this case is a single physical point-to-point Ethernet connection, and so the parameters that need to be agreed for the L2 Technology Service Attribute are the same as those described in section 13.3.1.

### 13.3.5 Point to Point Protocol (PPP)

A common method for connecting Subscribers and Service Providers over point-to-point links is to use the Point-to-Point Protocol (PPP), defined in RFC 1661 [5], or variants of it. As well as a method for encapsulating datagrams, PPP provides a Link Control Protocol (LCP) for establishing, configuring, and testing the data-link connection, and a family of Network Control Protocols (NCPs) for establishing and configuring different network-layer protocols. The original version was often used for dial-up Internet access. Newer variants, e.g., PPP over ATM (PPPoA) and PPP over Ethernet (PPPoE) are used for broadband access over Digital Subscriber Lines (DSL).

In these cases, the UNI Access Link L2 Technology Service Attribute is set to PPP, and the appropriate PPP parameters (including LCP and NCP parameters) need to be agreed. The only lower layer is the physical layer over which PPP is running (e.g. DSL, Ethernet or ATM), and any characteristics of the physical layer need to be agreed.

### 13.3.6 Point-to-Point Ethernet Link using an E-Access service

A common case is where the SP provides a single physical point-to-point Ethernet connection to the Subscriber, but uses an Access E-Line Service (MEF 51.1 [69]) to connect the IP UNI to the SP's IP PE.

From the Subscriber's perspective, this case is identical to the example in section 13.3.1, and hence the same information is needed in the value of the Service Attribute: the L2 Technology would be Ethernet, and no additional L2 parameters are needed but here the type of Ethernet PHY needs to be specified, along with any other physical layer attributes such as auto-negotiation and the type of optical fiber.

The details of the Access E-Line service are invisible to the Subscriber and hence are not part of the definition of the Subscriber IP Service. They are agreed between the SP and the Ethernet Access Provider.

Note that the SP could instead use an Access E-LAN Service or an E-Access O-Tree Service (MEF 51.1 [69]) to connect multiple IP UNI Access Links to the SP's IP PE. Again, from the Subscriber's perspective, this is identical to a physical Ethernet connection; the existence and details of the E-Access service are agreed between the SP and the Ethernet Access Provider, and are invisible to the Subscriber. An example is shown in Appendix E.

## 13.4 UNI Access Link IPv4 Connection Addressing Service Attribute

The UNI Access Link IPv4 Connection Addressing specifies how IPv4 addresses are allocated to the devices connected to the UNI Access Link. It is one of the four values *None*, *DHCP*, *Static* or *Unnumbered*, plus in the case of *DHCP* or *Static*, some additional parameters.

If the IPv4 Connection Addressing is *None*, no IPv4 addresses are used by the devices connected to the UNI Access Link and IPv4 is disabled on the link. Note that in this case IPv6 connection addresses are needed.

**[R128]** The UNI Access Link IPv4 Connection Addressing Service Attribute and the UNI Access Link IPv6 Connection Addressing Service Attribute (section 13.5) **MUST NOT** both have the value *None*.

If the IPv4 Connection Addressing is *DHCP*, then DHCP is used by the Subscriber devices to request IPv4 addresses in a given subnet from the SP or Operator as described in RFC 2131 [8] and RFC 2132 [9]. The SP or Operator device acts as the DHCP server and the Subscriber devices act as the DHCP clients.

- [R129]** When the IPv4 Connection Addressing is *DHCP*, the SP or Operator **MUST** use DHCP to convey to the Subscriber, in addition to the IPv4 address, the subnet mask and router address.

If the IPv4 Connection Addressing is *Static*, then IPv4 addresses in a given IPv4 subnet are statically assigned to the SP or Operator and to the Subscriber.

For *DHCP* and *Static*, a number of further parameters have to be agreed:

- Primary Subnet:
  - IPv4 Prefix (IPv4 address prefix and mask length between 0 and 31, in bits).
  - Service Provider (for Subscriber IP Services) or Operator (for Operator IP Services) IPv4 Addresses (Non-empty list of IPv4 addresses).
  - Subscriber IPv4 Address (IPv4 address or *Not Specified*).
  - Reserved Prefixes List (List of IPv4 Prefixes, possibly empty).
- Secondary Subnet List; each entry containing:
  - IPv4 Prefix (IPv4 address prefix and mask length between 0 and 31, in bits).
  - Service Provider (for Subscriber IP Services) or Operator (for Operator IP Services) IPv4 Addresses (Non-empty list of IPv4 addresses).
  - Reserved Prefixes List (List of IPv4 Prefixes, possibly empty).

The parameters consist of a primary subnet and zero or more secondary subnets. In each case, the IP Prefix is specified, along with the SP's or Operator's IPv4 addresses. In the case of the primary subnet, this IP Prefix is referred to as the Connection Primary IPv4 Prefix, and for a secondary subnet, the Connection Secondary IPv4 Prefix.

Note that the IPv4 Prefix and SP addresses need to be agreed even when DHCP is used, so that the Subscriber can ensure they do not conflict with any other addressing used within the Subscriber Network.

For the primary subnet, if Static addressing is used, the Subscriber's IPv4 address can also be specified.

A list (possibly empty) of reserved IP Prefixes can be specified; these specify IP addresses that are not available for the Subscriber to assign statically. If DHCP is used, the IPv4 address range from which addresses are dynamically assigned is taken from this pool of reserved addresses.

When Static addressing is used, the SP's or Operator's addresses are assumed to also be the router/gateway addresses, via which the Subscriber can route traffic over this UNI Access Link.

- [R130]** For a Subscriber IP Service, if the UNI Access Link Connection Type (section 13.2) is *P2P* and the UNI Access Link IPv4 Connection Addressing is *Static* or *DHCP*, for the Primary Subnet and for each Secondary Subnet, there **MUST** be only one Service Provider IPv4 Address specified.

- [R131]** For an Operator IP Service, if the UNI Access Link Connection Type (section 13.2) is *P2P* and the UNI Access Link IPv4 Connection Addressing is *Static* or

*DHCP*, for the Primary Subnet and for each Secondary Subnet, there **MUST** be only one Operator IPv4 Address specified.

If the connection type is *Multipoint*, there could be many Subscriber devices attached to the UNI Access Link, all with different IPv4 addresses. In this case the Subscriber's IPv4 address can be set to *Not Specified*. Alternatively, there could be a single Subscriber device and multiple SP or Operator devices.

- [R132] If the IPv4 Connection Addressing is *Static* or *DHCP*, for the Primary Subnet and for each Secondary Subnet, the Service Provider or Operator IPv4 Addresses **MUST** be within the specified IPv4 Prefix.
- [R133] If the UNI Access Link IPv4 Connection Addressing is *Static*, and the Primary Subnet Subscriber IPv4 Address is an IPv4 address, it **MUST** be an IPv4 address within the Connection Primary IPv4 Prefix, that is different to the Primary Subnet Service Provider IPv4 Addresses or Primary Subnet Operator IPv4 Addresses.
- [R134] If the UNI Access Link IPv4 Connection Addressing is *DHCP*, the Primary Subnet Subscriber IPv4 Address **MUST** be *Not Specified*.
- [R135] IP Prefixes contained in the Primary Subnet Reserved Prefixes List **MUST** contain a subset of IPv4 addresses that are within the Connection Primary IPv4 Prefix.
- [R136] If the UNI Access Link IPv4 Connection Addressing is *DHCP*, addresses that are dynamically assigned by DHCP within the Connection Primary IPv4 Prefix **MUST** be taken from within one of the IP Prefixes in the Primary Subnet Reserved Prefixes List.
- [R137] IP Prefixes contained in the Reserved Prefixes List in an entry in the Secondary Subnet List **MUST** contain a subset of IPv4 addresses that are within the Connection Secondary IPv4 Prefix for that entry in the Secondary Subnet List.
- [R138] If the UNI Access Link IPv4 Connection Addressing is *DHCP*, addresses that are dynamically assigned by DHCP within the Connection Secondary IPv4 Prefix for an entry in the Secondary Subnet List **MUST** be taken from within one of the IP Prefixes in the Reserved Prefixes List for that entry in the Secondary Subnet List.

The Subscriber can statically assign any IPv4 address within the subnets identified by the Connection IPv4 Prefixes, other than the SP address itself, the lowest and highest possible addresses, which are generally reserved, and any addresses reserved for dynamic assignment.

- [R139] If the UNI Access Link IPv4 Connection Addressing is *DHCP* or *Static*, the Subscriber **MUST NOT** statically assign any of the following for use on the UNI Access Link by Subscriber devices:

- Any IPv4 address that is neither within the Connection Primary IPv4 Prefix nor within the Connection Secondary IPv4 Prefix for an entry in the Secondary Subnet List.
- Any IPv4 address within the Connection Primary IPv4 Prefix other than the Primary Subnet Subscriber IPv4 Address, unless it is *Not Specified*.
- Any of the Primary Subnet Service Provider IPv4 Addresses.
- Any of the Service Provider IPv4 Addresses specified an entry in the Secondary Subnet List.
- The lowest and highest IPv4 addresses in the Connection Primary IPv4 Prefix, if the prefix length is less than or equal to 30.
- The lowest and highest IPv4 addresses in the Connection Secondary IPv4 Prefix for an entry in the Secondary Subnet List, if the prefix length is less than or equal to 30.
- Any IPv4 address within an IP Prefix in the Primary Subnet Reserved Prefixes List or within the Reserved Prefixes List for an entry in the Secondary Subnet List.

If the IPv4 Connection Addressing is *Unnumbered*, then the SP or Operator and the Subscriber each assign an IPv4 address (from their own address pools) independently. These addresses can be on different IP subnets, and so an interface-based routing protocol (see section 12.7) is needed to ensure reachability. *Typically the IPv4 address is configured on a loopback interface and shared between several other interfaces; however, the implementation is not constrained by this specification.*

**[R140]** If the IPv4 Connection Addressing is *Unnumbered*, the UNI Access Link Connection Type Service Attribute (section 13.2) **MUST** be *P2P*.

If two Subscribers obtain Internet access services from the same SP, it is possible that the SP allocates the same private IPv4 address to both Subscribers (either statically or using DHCP), and may translate these to the same public IPv4 address (using different port numbers to distinguish between traffic for the different Subscribers). This is possible using “Carrier Grade NAT” as described in RFC 6888 [48].

**[R141]** When two or more Subscribers obtain cloud access IPVCs from an SP with the Cloud Type (section 10.13.1) set to *Internet Access*, and for each Subscriber’s IPVC, the SP allocates the same IPv4 address (statically or using DHCP) on a UNI Access Link in a UNI that the IPVC is attached to, the best current practice documented in RFC 6888 [48] **MUST** be followed.

Note that the use of Carrier Grade NAT is intended to be opaque to the Subscriber; however there are some scenarios where this is not the case, as described in RFC 7021 [49]. Allowing the Subscriber and SP to agree to disable Carrier Grade NAT may be addressed in a future version of this specification. Carrier Grade NAT can be used in conjunction with NAT for cloud access services (section 10.13.4), or without it.

### 13.5 UNI Access Link IPv6 Connection Addressing Service Attribute

The UNI Access Link IPv6 Connection Addressing specifies how IPv6 addresses are allocated to the devices connected to the UNI Access Link. It is one of the five values *None*, *DHCP*, *SLAAC*, *Static* or *LL-only*, plus in the case of *DHCP*, *SLAAC* or *Static*, some additional parameters.

If the IPv6 Connection Addressing is *None*, no IPv6 addresses are used by the devices connected to the UNI Access Link and IPv6 is disabled on the link. Note that in this case IPv4 connection addresses are needed (see [R128]).

If the IPv6 Connection Addressing is not *None*, then IPv6 link local addresses are used on the UNI Access Link. If the value is *LL-only*, these are the only IPv6 addresses used on the UNI Access Link.

If the IPv6 Connection Addressing is *DHCP*, then DHCPv6 is used by the Subscriber devices to request IPv6 addresses in a given subnet from the SP or Operator as described in RFC 8415 [60]. The SP or Operator device acts as the DHCP server and the Subscriber devices act as the DHCP clients.

**[R142]** When the IPv6 Connection Addressing is *DHCP*, the SP or Operator **MUST** use DHCP to convey to the Subscriber, in addition to the IPv6 address, the subnet mask and router address.

If the IPv6 Connection Addressing is *Static*, then IPv6 addresses in a given IPv6 subnet are statically assigned to the SP or Operator and to the Subscriber.

If the IPv6 Connection Addressing is *SLAAC*, then Stateless Address Autoconfiguration (SLAAC) is used by the Subscriber devices to create unique IPv6 global addresses within an IP Prefix advertised by the SP or Operator as described in RFC 4862 [35]. The Router Advertisements that convey the IP Prefix can also be used to determine the subnet mask and router address.

For *DHCP*, *SLAAC* and *Static*, a number of further parameters have to be agreed:

- Subnet List of one or more subnets, each comprising:
  - IPv6 Prefix (IPv6 address prefix and mask length between 0 and 127, in bits).
  - Service Provider (for Subscriber IP Services) or Operator (for Operator IP Services) IPv6 Addresses (Non-empty list of IPv6 addresses).
  - Reserved Prefixes List (List of IPv6 Prefixes, possibly empty).
- For *Static*, Subscriber IPv6 Address (IPv6 address or *Not Specified*).

The parameters consist of a list of one or more subnets. For each subnet, the IPv6 prefix and the SP's or Operator's IPv6 address are specified. The IPv6 Prefix is referred to as the Connection IPv6 Prefix. Note that an IP Prefix and SP addresses need to be agreed even when DHCP or SLAAC is used, so that the Subscriber can ensure they do not conflict with any other addressing used within the Subscriber Network.

If Static addressing is used, the Subscriber's IPv6 address can also be specified.

A list (possibly empty) of reserved IP Prefixes can be specified; these specify IP addresses that are not available for the Subscriber to assign statically. If DHCP is used, the IPv6 address range from which addresses are dynamically assigned is taken from this pool of reserved addresses.

When Static addressing is used, the SP's or Operator's addresses are assumed to also be the router/gateway addresses, via which the Subscriber can route traffic over this UNI Access Link.

- [R143] For a Subscriber IP Service, if the UNI Access Link Connection Type (section 13.2) is *P2P* and the UNI Access Link IPv6 Connection Addressing is *Static*, *DHCP* or *SLAAC*, for each subnet, there **MUST** be only one Service Provider IPv6 Address specified.
- [R144] For an Operator IP Service, if the UNI Access Link Connection Type (section 13.2) is *P2P* and the UNI Access Link IPv6 Connection Addressing is *Static*, *DHCP* or *SLAAC*, for each subnet, there **MUST** be only one Operator IPv6 Address specified.

If the connection type is *Multipoint*, there could be many Subscriber devices attached to the UNI Access Link, all with different IPv6 addresses. In this case the Subscriber's IPv6 address can be set to *Not Specified*. Alternatively, there could be a single Subscriber device and multiple SP or Operator devices.

- [R145] If the IPv6 Connection Addressing is *Static*, *DHCP* or *SLAAC*, for each entry in the Subnet List, the Service Provider or Operator IPv6 Addresses **MUST** be within the Connection IPv6 Prefix for that entry.
- [R146] If the UNI Access Link IPv6 Connection Addressing is *Static*, and the Subscriber IPv6 Address is an IPv6 address, it **MUST** be an IPv6 address within the Connection IPv6 Prefix for the first entry in the Subnet List, that is different to the Service Provider or Operator IPv6 Addresses for that entry.
- [R147] If the UNI Access Link IPv6 Connection Addressing is *DHCP* or *SLAAC*, the Subscriber IPv6 Address **MUST** be *Not Specified*.
- [R148] For a given entry in the Subnet List, IP Prefixes contained in the Reserved Prefixes List **MUST** contain a subset of IPv6 addresses that are within the Connection IPv6 Prefix for that entry.
- [R149] If the UNI Access Link IPv6 Connection Addressing is *DHCP*, addresses that are dynamically assigned by DHCP **MUST** be taken from within one of the IP Prefixes in the Reserved Prefixes List for one of the entries in the Subnet List.
- [R150] If the UNI Access Link IPv6 Connection Addressing is *SLAAC*, the IP Prefix advertised by the SP or Operator as described in RFC 4862 [35] using Router Advertisements **MUST** be the Connection IPv6 Prefix for the first entry in the Subnet List.

The Subscriber can statically assign any IPv6 address within the subnets identified by the Connection IPv6 Prefix in each entry, other than the SP address itself, the lowest and highest possible addresses, which are generally reserved, and any addresses reserved for dynamic assignment.

**[R151]** If the UNI Access Link IPv6 Connection Addressing is *DHCP*, *SLAAC* or *Static*, the Subscriber **MUST NOT** statically assign any of the following for use on the UNI Access Link by Subscriber devices:

- Any IPv6 address that is not within the Connection IPv6 Prefix for an entry in the Subnet List.
- Any IPv6 address within the Connection IPv6 Prefix for the first entry in the Subnet List, if the UNI Access Link IPv6 Connection Addressing is *SLAAC*.
- Any IPv6 address within the Connection IPv6 Prefix for the first entry in the Subnet List other than the Subscriber IPv6 Address, unless it is *Not Specified*.
- Any of the Service Provider IPv6 Addresses specified in an entry in the Subnet List.
- The lowest and highest IPv6 addresses in the Connection IPv6 Prefix for an entry in the Subnet List, if the prefix length is less than or equal to 126.
- Any IPv6 address within an IP Prefix in the Reserved Prefixes in an entry in the Subnet List.

### 13.6 UNI Access Link DHCP Relay Service Attribute

The UNI Access Link DHCP Relay Service Attribute is either *Disabled* or a pair containing an IPVC EP Identifier (section 11.1) for one of the IPVC EPs at the UNI that the UNI Access Link is in, and a non-empty list of IP addresses for DHCP Servers belonging to the Subscriber. If the value is *Disabled*, DHCP Relay functionality for the Subscriber is disabled.

If the value is not *Disabled*, then the SP or Operator enables DHCP Relay functionality on the UNI Access Link, as described in RFC 3046 [19]. DHCP Relay functionality is useful when the Subscriber uses DHCP (per RFC 2131 [8] and RFC 8415 [60]) in the Subscriber Network, but does not want to place a DHCP server (or possibly a pair of redundant DHCP servers) in each part of the network. As DHCP packets do not traverse routers, additional functionality needs to be provided by the SP or Operator, to enable hosts in one part of the Subscriber Network to access DHCP servers in another part of the Subscriber Network.

In brief, DHCP relay functionality works by listening for multicast DHCP requests on the local LAN, but actually forwarding (using unicast packets) the request to one or more remote DHCP servers rather than responding to it directly. An additional DHCP option (per RFC 3046 [19]) is inserted into the request so that the remote server can unicast a response, and the option is stripped out of the response before being forwarded back to the local LAN.

Note that DHCP relay functionality is relevant when the Subscriber uses their own DHCP servers; this is distinct from the case where DHCP is used for the connection addressing (sections 13.4 and



13.5) – in the latter case, it is the SP (or an Operator acting on their behalf) that has the DHCP servers.

- [R152] When the UNI Access Link DHCP Relay Service Attribute is not *Disabled*, the SP or Operator **MUST** enable DHCP Relay functionality as described in RFC 3046 [19] on the UNI Access Link, so that DHCP requests are forwarded to the DHCP servers specified by the IP addresses in the value of the attribute, via the IPVC EP specified in the value of the attribute.

The reachability of the listed DHCP server addresses is determined in the same way as for Ingress IP Data Packets at the UNI that are mapped to the given IPVC EP.

- [R153] When the UNI Access Link DHCP Relay Service Attribute is not *Disabled*, DHCP requests that are forwarded to an IP address specified in the value of the attribute **MUST** be delivered in the same way as an Ingress IP Data Packet on the UNI Access Link with a destination address equal to the IP address in the attribute, that is mapped to the IPVC EP specified in the value of the attribute.
- [O17] The SP or Operator **MAY** add additional DHCP Options in the forwarded DHCP request.
- [R154] The SP or Operator **MUST NOT** remove any DHCP Options from the forwarded DHCP request.
- [O18] The SP or Operator **MAY** modify the value of DHCP Options in the forwarded DHCP request.
- [R155] If the UNI Access Link DHCP Relay Service Attribute is not *Disabled*, and the list of DHCP servers includes at least one IPv4 address, the UNI Access Link IPv4 Connection Addressing (section 13.4) **MUST** be set to *Static* or *Unnumbered*.
- [R156] If the UNI Access Link DHCP Relay Service Attribute is not *Disabled*, and the list of DHCP servers includes at least one IPv6 address, the UNI Access Link IPv6 Connection Addressing (section 13.5) **MUST** be set to *Static* or *LL-only*.

To protect their network and ensure it performs sufficiently well, the SP or Operator might want to limit the rate at which requests are forwarded. This does not need to be agreed with the Subscriber, since the DHCP protocol is robust against not receiving a response, and will retry.

- [O19] The SP or Operator **MAY** limit the rate of DHCP requests that are forwarded.

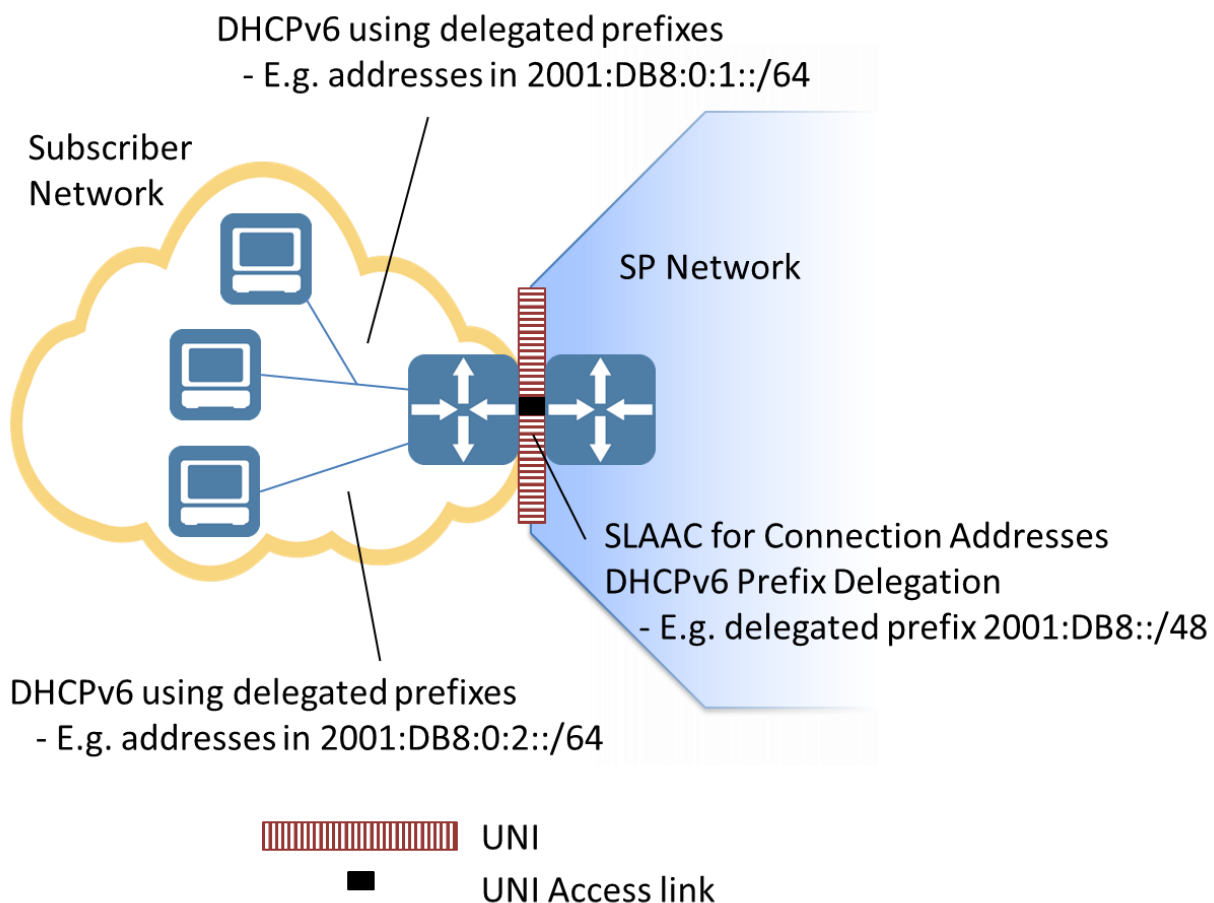
### 13.7 UNI Access Link Prefix Delegation Service Attribute

In certain situations (particularly for Internet access), a Subscriber might not have their own IP Prefixes for use in the Subscriber Network, but instead be allocated IP Prefixes dynamically by the SP (or Operator) when they first connect. For IPv6 Prefixes, this can be done using DHCPv6 Prefix Delegation as described in RFC 8415 [60]. The UNI Access Link Prefix Delegation Service

Attribute indicates whether DHCPv6 Prefix Delegation is enabled over the UNI Access Link, and takes values *Enabled* or *Disabled*. It is typically used in combination with DHCP or SLAAC for the UNI Access Link IPv6 Connection Addressing (section 13.5).

- [R157] When the UNI Access Link Prefix Delegation Service Attribute is *Enabled*, DHCPv6 Prefix Delegation as described in RFC 8415 [60] **MUST** be enabled for the UNI Access Link.
- [R158] When the UNI Access Link Prefix Delegation Service Attribute is *Enabled*, the UNI Access Link IPv6 Connection Addressing (section 13.5) **MUST NOT** be *None*.
- [R159] When the UNI Access Link Prefix Delegation Service Attribute is *Enabled*, the UNI Access Link **MUST** be the only UNI Access Link in the UNI with UNI Access Link Prefix Delegation Service Attribute set to *Enabled*.

A possible scenario for the use of DHCPv6 Prefix Delegation is illustrated in Figure 29.



**Figure 29 – DHCPv6 Prefix Delegation**

In this example, SLAAC is used for the connection addresses across the UNI Access Link, and DHCPv6 Prefix Delegation is used to delegate an IPv6 Prefix from the SP to the Subscriber. The

Subscriber's router can then use DHCPv6 to allocate IPv6 addresses taken from this delegated prefix to hosts within the Subscriber Network.

Note that for correct operation, the SP (or Operator) adds a route towards the delegated prefix over the UNI Access Link – in other words, it adds the route to the UNI<sub>L</sub> routing information database, as described in section 9.

DHCPv6 Prefix Delegation is more commonly used with a Subscriber-Managed CE; however, use with a Provider-Managed CE (i.e. between the CE and a router in the Subscriber Network) is not precluded. Note that use of Prefix Delegation between a Provider-Managed CE and a PE would be internal to the SP Network and hence outside the scope of this specification.

### 13.8 UNI Access Link BFD Service Attribute

The UNI Access Link BFD Service Attribute indicates whether Bidirectional Forwarding Detection (BFD) is enabled on the UNI Access Link, and if so the parameters that need to be agreed. It is either *None* or a set of parameters consisting of:

- Connection Address Family (*IPv4*, *IPv6* or *Both*).
- Transmission Interval (time in ms).
- Detect Multiplier (integer).
- Active End (*Subscriber*, *SP* or *Both*).
- Authentication Type (*None*, *Simple Password*, *Keyed MD5*, *Meticulous Keyed MD5*, *Keyed SHA1*, *Meticulous Keyed SHA1*).

Note that although BFD implementations often have many configurable parameters, the above parameters are restricted to those that need to be agreed between the Subscriber and the SP (or between a SP/SO and an Operator) in order to operate BFD across the UNI Access Link.

The Connection Address Family parameter specifies whether the session is established over IPv4 or IPv6, or whether two separate sessions are established using IPv4 and IPv6. The sessions are established using the addresses in the UNI Access Link IPv4 Connection Addressing Service Attribute (section 13.4) or the UNI Access Link IPv6 Connection Addressing Service Attribute (section 13.5). Note that when DHCP is used, BFD sessions cannot be established until the Subscriber's IP address has been allocated via DHCP.

**[R160]** When the UNI Access Link BFD Service Attribute is not *None* and the Connection Address Family parameter is *IPv4* or *Both*, the UNI Access Link IPv4 Connection Addressing Service Attribute (section 13.4) **MUST** be *Static* or *DHCP*.

**[R161]** When the UNI Access Link BFD Service Attribute is not *None* and the Connection Address Family parameter is *IPv4* or *Both*, BFD as specified in RFC 5880 [44] and RFC 5881 [45], or where applicable, as specified in RFC 7130 [50], **MUST** be enabled using the Primary Subnet IPv4 addresses specified in the UNI Access Link IPv4 Connection Addressing Service Attribute (section 13.4), if the UNI Access Link IPv4 Connection Addressing Service Attribute is *Static*.

- [R162]** When the UNI Access Link BFD Service Attribute is not *None* and the Connection Address Family parameter is *IPv4* or *Both*, BFD as specified in RFC 5880 [44] and RFC 5881 [45], or where applicable, as specified in RFC 7130 [50], **MUST** be enabled using the Primary Subnet SP IPv4 addresses or Primary Subnet Operator IPv4 addresses specified in the UNI Access Link IPv4 Connection Addressing Service Attribute (section 13.4), and the Primary Subnet IPv4 address allocated to the Subscriber using DHCP, if the UNI Access Link IPv4 Connection Addressing Service Attribute is *DHCP*.
- [R163]** When the UNI Access Link BFD Service Attribute is not *None* and the Connection Address Family parameter is *IPv6* or *Both*, the UNI Access Link IPv6 Connection Addressing Service Attribute (section 13.5) **MUST NOT** be *None*.
- [R164]** When the UNI Access Link BFD Service Attribute is not *None* and the Connection Address Family parameter is *IPv6* or *Both*, BFD as specified in RFC 5880 [44] and RFC 5881 [45], or where applicable, as specified in RFC 7130 [50], **MUST** be enabled using the IPv6 addresses for the first entry in the Subnet List specified in the UNI Access Link IPv6 Connection Addressing Service Attribute (section 13.5), if the UNI Access Link IPv6 Connection Addressing Service Attribute is *Static*.
- [R165]** When the UNI Access Link BFD Service Attribute is not *None* and the Connection Address Family parameter is *IPv6* or *Both*, BFD as specified in RFC 5880 [44] and RFC 5881 [45], or where applicable, as specified in RFC 7130 [50], **MUST** be enabled using the IPv6 link local addresses on the UNI Access Link if the UNI Access Link IPv6 Connection Addressing Service Attribute (section 13.5) is not *Static*.

BFD has two operating modes: asynchronous mode, and demand mode. As described in RFC 5880 [44], BFD sessions are initially established in asynchronous mode; thereafter, either peer can independently switch to demand mode. As this is negotiated in-band within the protocol, there is nothing that needs to be agreed beforehand between the SP and the Subscriber (or between a SP/SO and an Operator).

- [R166]** If the Subscriber, the SP or an Operator support a value for the UNI Access Link BFD Service Attribute other than *None*, they **MUST** support asynchronous mode.
- [O20]** If the Subscriber, the SP or an Operator support a value for the UNI Access Link BFD Service Attribute other than *None*, they **MAY** support demand mode.

BFD allows for asymmetrical operation, where packets can be sent at different intervals in each direction, and a different detect multiplier can be used. For simplicity, this specification mandates symmetrical operation.

- [R167] When the UNI Access Link BFD Service Attribute is not *None*, the Desired Minimum Transmit Interval and the Required Minimum Receive Interval **MUST** be set to the specified Transmission Interval in normal operation.
- [O21] A longer transmission interval **MAY** be used during abnormal periods.

Optional Requirement [O21] allows for implementations that adjust the interval temporarily to keep the session up in certain cases.

RFC 7419 [51] specifies a set of common intervals which are used to ensure interoperability: 3.3ms, 10ms, 20ms, 50ms, 100ms and 1s.

- [R168] If the Subscriber, the SP or an Operator supports a value for the UNI Access Link BFD Service Attribute other than *None*, they **MUST** support Transmission intervals of 100ms and 1s.
- [R169] If the Subscriber, the SP or an Operator supports a value for the UNI Access Link BFD Service Attribute other than *None* and one of the common intervals specified in RFC 7419 [51] is supported, all of the longer common intervals specified in RFC 7419 [51] **MUST** be supported.
- [R170] When the UNI Access Link BFD Service Attribute is not *None*, the Detect Multiplier **MUST** be set to the specified value.

At least one end of the BFD session has to have an active role, meaning that it sends out asynchronous control messages regardless of whether it has received any.

- [R171] When the UNI Access Link BFD Service Attribute is not *None*, the Subscriber device **MUST** take an Active role if the Active End is *Subscriber* or *Both*, and a Passive role otherwise.
- [R172] When the UNI Access Link BFD Service Attribute is not *None*, the SP or Operator device **MUST** take an Active role if the Active End is *SP* or *Both*, and a Passive role otherwise.

If BFD is used, when the BFD session is down, the UNI Access Link is usually considered non-operational. This has an impact on routes towards the UNI Access Link, as described in section 9.1.

- [D18] When the UNI Access Link BFD Service Attribute is not *None*, if the BFD Session is not in UP state (as described in RFC 5880 [44]), the UNI Access Link **SHOULD** be considered non-operational for the purpose of determining whether routes towards the UNI Access Link are active, as described in section 9.1.

The BFD Echo function can be supported, in the sense of being able to receive and loop back echo packets, by the Subscriber, the SP or an Operator.

- [O22] The Subscriber **MAY** support the BFD Echo function.

[O23] The SP **MAY** support the BFD Echo function.

[O24] An Operator at the UNI **MAY** support the BFD Echo function.

BFD has several options for authentication.

[R173] When the UNI Access Link BFD Service Attribute is not *None*, and the Authentication Type is not *None*, the specified authentication type **MUST** be used as described in RFC 5880 [44].

Note: the additional parameters that need to be agreed for each authentication type are deferred to a future version of this specification.

### 13.9 UNI Access Link IP MTU Service Attribute

The UNI Access Link IP Maximum Transmit Unit (MTU) Service Attribute is an integer  $\geq 576$  that specifies the maximum length in octets of IP Packets that can be conveyed across the UNI Access Link. It is used to determine the maximum value of the IPVC MTU (see section 10.10) for IPVCs attached to the UNI containing the UNI Access Link, and also affects IP Control Protocol Packets at the UNI Access Link.

RFC 791 [1] specifies the minimum MTU for IPv4 Packets as 68 octets; however, it also requires that all devices can handle a packet of length 576 octets (possibly fragmented). This specification strengthens the requirements from RFC 791 [1], by defining the minimum MTU as 576 octets – that is, IPv4 Packets that are shorter than this are guaranteed not to be fragmented or discarded.

RFC 8200 [57] specifies the minimum MTU for IPv6 Packets as 1280 octets; therefore this value is recommended in all cases.

[D19] The UNI Access Link IP MTU **SHOULD** be greater than or equal to 1280 octets.

Note that if the UNI Access Link is in a UNI that has an IPVC with IPv6 enabled attached to it, the combination of [R41] and [R43] means that the UNI Access Link IP MTU has to be greater than or equal to 1280.

Note also that the underlying Layer 2 technology that supports the UNI Access Link (see section 13.3) needs to be able to convey IP Packets whose length is equal to the value of the UNI Access Link IP MTU Service Attribute.

If an SP or Operator transmits IP Control Protocol Packets across a UNI Access Link, they cannot exceed the UNI Access Link IP MTU. Similarly, Ingress IP Control Protocol Packets with a length greater than the UNI Access Link IP MTU can be discarded by the SP or Operator, even if the corresponding protocol is normally peered. Note that the corresponding requirements for IP Data Packets can be found in section 10.10.

[R174] Egress IP Control Protocol Packets **MUST** have a length less than or equal to the value of the UNI Access Link IP MTU Service Attribute.

- [R175] Ingress IP Control Protocol Packets with a length less than or equal to the value of the UNI Access Link IP MTU Service Attribute **MUST NOT** be discarded due to their length.
- [O25] Ingress IP Control Protocol Packets with a length strictly greater than the value of the UNI Access Link IP MTU Service Attribute **MAY** be discarded.

Note that if OSPF is used on the UNI Access Link (see section 12.7.2), the MTU needs to be configured to the agreed value by both the Subscriber and the SP or Operator in order for OSPF to function correctly.

### 13.10 UNI Access Link Ingress Bandwidth Profile Envelope Service Attribute

The UNI Access Link Ingress Bandwidth Profile Envelope Service Attribute is either *None*, or a single Bandwidth Profile Envelope consisting of parameters and Bandwidth Profile Flow specifications, as described in section 17.3. If specified, the BWP Envelope is used for an ingress Bandwidth Profile.

An Ingress Bandwidth Profile Envelope can be specified for one of a UNI, a UNI Access Link, or an IPVC EP.

- [R176] For a UNI Access Link in a given UNI, if the UNI Access Link Ingress Bandwidth Profile Envelope Service Attribute is not *None*, the IPVC EP Ingress Bandwidth Profile Envelope Service Attribute (section 11.11) **MUST** be *None* for all IPVC EPs at the UNI.

Note that if the UNI Access Link Ingress Bandwidth Profile Envelope Service Attribute is not *None*, it follows from [R103] that the UNI Ingress Bandwidth Profile Envelope Service Attribute is *None*.

### 13.11 UNI Access Link Egress Bandwidth Profile Envelope Service Attribute

The UNI Access Link Egress Bandwidth Profile Envelope Service Attribute is either *None*, or a single Bandwidth Profile Envelope consisting of parameters and Bandwidth Profile Flow specifications, as described in section 17.3. If specified, the BWP Envelope is used for an egress Bandwidth Profile.

An Egress Bandwidth Profile Envelope can be specified for one of a UNI, a UNI Access Link, or an IPVC EP.

- [R177] For a UNI Access Link in a given UNI, if the UNI Access Link Egress Bandwidth Profile Envelope Service Attribute is not *None*, the IPVC EP Egress Bandwidth Profile Envelope Service Attribute (section 11.12) **MUST** be *None* for all IPVC EPs at the UNI.

Note that if the UNI Access Link Egress Bandwidth Profile Envelope Service Attribute is not *None*, it follows from [R105] that the UNI Egress Bandwidth Profile Envelope Service Attribute is *None*.

## 13.12 UNI Access Link Reserved VRIDs Service Attribute

As described in section 13.3.4, the SP or Operator can use the Virtual Router Redundancy Protocol (VRRP) specified in RFC 5798 [43] to implement a pair of redundant devices on the SP or Operator side of a UNI Access Link. The VRRP protocol supports multiple VRRP instances on the same IP subnet, each with a unique ID known as a VRID. A VRID, as defined in RFC 5798 [43], is a number between 1 and 255.

Since the protocol supports multiple instances, the Subscriber might also use VRRP on the UNI Access Link, for instance to provide redundant access to some service that is being provided to other Subscriber hosts on that subnet. To ensure there is no conflict, it is necessary to ensure that the SP or Operator and the Subscriber use different VRIDs.

The UNI Access Link Reserved VRIDs Service Attribute consists of a list of VRIDs (possibly empty) that are reserved for use by the SP or Operator. These VRIDs can be used for IPv4 or IPv6.

**[R178]** If the SP or Operator enables VRRP on the UNI Access Link, they **MUST** use VRIDs that are included in the UNI Access Link Reserved VRIDs Service Attribute.

**[R179]** If the Subscriber enables VRRP on the UNI Access Link, they **MUST NOT** use VRIDs that are included in the UNI Access Link Reserved VRIDs Service Attribute.

Note that if a VRID is included in the list, it does not mean that the SP or Operator has to use it. Whether or not the SP or Operator is using VRRP is opaque to the Subscriber, other than that if the UNI Access Link Reserved VRIDs Service Attribute is an empty list, the Subscriber can deduce that the SP or Operator is not using VRRP.

When the SP or Operator uses VRRP, only the common IP address that is shared between the redundant routers is visible to the Subscriber (i.e. it is the Service Provider IPv4 Address in the UNI Access Link IPv4 Connection Addressing Service Attribute (section 13.4), or the Service Provider IPv6 Address in the UNI Access Link IPv6 Connection Addressing Service Attribute (section 13.5)). However, the SP needs to ensure the Subscriber does not allocate to one of their devices the IP addresses used individually by each of the redundant routers. This can be achieved by ensuring these addresses are included in the Reserved Prefixes List in the UNI Access Link IPv4 Connection Addressing Service Attribute (section 13.4) or the UNI Access Link IPv6 Connection Addressing Service Attribute (section 13.5) as appropriate.



## 14 ENNI Service Attributes

This section specifies the Service Attributes for Operator IP Services that apply to each ENNI. For each ENNI supported by an Operator, there is one instance of these attributes for each SP/SO that uses the ENNI. The ENNI Service Attributes are agreed between the SP/SO and the Operator, as described in section 8.3. The attributes are summarized in Table 21 and described in more detail in the following subsections.

Attribute Name	Summary Description	Possible Values
ENNI Identifier	Unique identifier for the ENNI for management purposes.	Printable string that is unique across the SP's or Operator's network.
ENNI Type	Indication of the type of BGP Peering at the ENNI.	<i>Option A</i> , <i>Option B</i> , or <i>Option C</i> .
ENNI Routing Information	Per-service routing information applicable at the ENNI.	See section 14.3.
ENNI Ingress Bandwidth Profile Envelopes	Bandwidth Profile Envelope per ENNI Link used for an ingress Bandwidth Profile.	List of pairs of ENNI Service Mapping Identifiers and sets of parameters as specified in section 17.3.
ENNI Egress Bandwidth Profile Envelopes	Bandwidth Profile Envelope per ENNI Link used for an egress Bandwidth Profile.	List of pairs of ENNI Service Mapping Identifiers and sets of parameters as specified in section 17.3.

**Table 21 – ENNI Service Attributes**

### 14.1 ENNI Identifier Service Attribute

The ENNI Identifier is a unique string identifier for the ENNI. It can be used by the SP/SO and the Operator to identify the ENNI to each other.

- [R180] The ENNI Identifier **MUST** consist only of ASCII characters in the range 32-126 inclusive.
- [R181] The length of the ENNI Identifier **MUST** be less than or equal to 53 characters.
- [R182] The value of the ENNI Identifier Service Attribute **MUST** be unique among all such identifiers for ENNIs supported by the Operator.

### 14.2 ENNI Type Service Attribute

The ENNI Type Service Attribute indicates the type of BGP Peering used across the ENNI. The possible values are *Option A*, *Option B*, or *Option C*. These refer to the options described in RFC 4364 [31], and summarized in section 8.6. This attribute is used by the SP/SO and the Operator to agree the type of peering that will be used for the SP/SO's service across the ENNI, which can affect what functionality is possible at the ENNI. The Operator needs to ensure the value is consistent with the type of peering that they have agreed with the peer LLO, according to the ENNI

Peering Type Common Attribute (section 15.2). The SP/SO needs to ensure the same value is agreed with the Operators on both sides of the ENNI.

- [R183]** The value of the ENNI Type Service Attribute for an ENNI **MUST** be consistent with the value of the ENNI Peering Type Common Attribute (section 15.2) at that ENNI.

### 14.3 ENNI Routing Information Service Attribute

The ENNI Routing Information Service Attribute includes per-service routing information that is used at the ENNI, by the routing protocols described in the ENNI Routing Protocols Common Attribute (section 15.5). The details of this attribute depend on the value of the ENNI Type Service Attribute (section 14.2). When the ENNI Type Service Attribute is *Option A*, the values and requirements of this attribute are described in section 14.3.1. The values and requirements for other cases are deferred to a future version of this specification.

#### 14.3.1 ENNI Routing Protocols for Option A

For an ENNI using Option A, the ENNI Routing Information Service Attribute is a mapping of ENNI Service Mapping Identifiers to four-tuples of the form (Administrative Distance, Route Flap Damping, AS Override, Static Routes). These four elements are described in the following subsections. Each four-tuple applies to the corresponding ENNI Service Mapping Identifier.

##### 14.3.1.1 *Administrative Distance*

The Administrative Distance for a given ENNI Service Mapping Identifier is an integer greater than 0 that indicates the value of the administrative distance assigned by the Operator to eBGP routes received from another Operator over the ENNI Links that are assigned to that ENNI Service Mapping Identifier (via the ENNI Service Map Common Attribute, section 15.6), at an ENNI using Option A. The administrative distance is a numeric metric used to control which routes are selected, when there are multiple routes for the same IP Prefix. A lower number indicates a more preferable route. The administrative distance is used by an LLO as described in section 15.5 and requirement [R207].

If a given ENNI Service Mapping Identifier does not appear in the value of the ENNI Routing Information Service Attribute, an administrative distance of 20 is used by the LLO for eBGP routes received over ENNI Links that are assigned to that ENNI Service Mapping Identifier.

##### 14.3.1.2 *Route Flap Damping*

The Route Flap Damping parameter for a given ENNI Service Mapping Identifier indicates whether the Operator applies route flap damping to routes received from another Operator over the ENNI Links assigned to that ENNI Service Mapping Identifier (via the ENNI Service Map Common Attribute, section 15.6). It takes the values *Enabled* or *Disabled*.

- [R184]** When the Route Flap Damping parameter for a given ENNI Service Mapping Identifier is *Enabled*, the Operator **MUST** apply route flap damping as described in RFC 2439 [12] to routes received over the ENNI Links assigned (via

the ENNI Service Map Common Attribute, section 15.6) to the ENNI Service Mapping Context comprising the SP/SO and that ENNI Service Mapping Identifier.

**[R185]** When the Route Flap Damping parameter for a given ENNI Service Mapping Identifier is *Disabled*, the Operator **MUST NOT** apply route flap damping to routes received over the ENNI Links assigned (via the ENNI Service Map Common Attribute, section 15.6) to the ENNI Service Mapping Context comprising the SP/SO and that ENNI Service Mapping Identifier.

**[R186]** If a given ENNI Service Mapping Identifier does not appear in the value of the ENNI Routing Information Service Attribute, the Operator **MUST NOT** apply route flap damping to routes received over the ENNI Links assigned (via the ENNI Service Map Common Attribute, section 15.6) to the ENNI Service Mapping Context comprising the SP/SO and that ENNI Service Mapping Identifier.

### 14.3.1.3 AS Override

The AS Override parameter for a given ENNI Service Mapping Identifier indicates whether AS Override behavior (described in section 12.7.3) is enabled at the ENNI, for routes advertised towards another Operator over the ENNI Links assigned to that ENNI Service Mapping Identifier (via the ENNI Service Map Common Attribute, section 15.6). It takes the values *Enabled*, *Disabled*, or *Other*. A value of *Enabled* means that AS Override is enabled for routes advertised over the ENNI, as described below. A value of *Other* means that some other form of AS Override or another mechanism is used to manipulate the AS Path in routes advertised over the ENNI. A value of *Disabled* means there is no special AS Path handling.

AS Override can be useful at an ENNI in the scenario where the same Operator is used in different parts of an end-to-end IPVC – for example, to provide access to two different UNIs. In this instance, routes received from the Operator across an ENNI can be advertised back to the Operator across a different ENNI. An example is shown in Appendix D.2.

**[R187]** When the AS Override parameter for a given ENNI Service Mapping Identifier is *Enabled*, the Operator **MUST** overwrite all instances of the peer Operator's AS Number in the AS Path with their own AS Number, in routes advertised to the other Operator over the ENNI Links assigned (via the ENNI Service Map Common Attribute, section 15.6) to the ENNI Service Mapping Context comprising the SP/SO and that ENNI Service Mapping Identifier.

[R187] requires that the peer Operator's AS Number is overridden. It is noted that in cases where the peer Operator's AS Number is not the originating AS Number (i.e. the last AS Number in the AS Path), for example because the Subscriber uses BGP across the UNI, not all implementations of AS Override support this capability, and hence an LLO might not be able to support a value of *Enabled* for the AS Override parameter. In this case, a value of *Other* can be used.

**[R188]** When the AS Override parameter for a given ENNI Service Mapping Identifier is *Other*, details of how the Operator changes the AS Path in routes advertised to the other Operator over the ENNI Links assigned (via the ENNI Service Map

Common Attribute, section 15.6) to the ENNI Service Mapping Context comprising the SP/SO and that ENNI Service Mapping Identifier **MUST** be agreed between the Operator and the SP/SO.

- [R189]** When the AS Override parameter for a given ENNI Service Mapping Identifier is *Disabled*, the Operator **MUST NOT** abnormally change the AS Path in routes advertised to the other Operator over the ENNI Links assigned (via the ENNI Service Map Common Attribute, section 15.6) to the ENNI Service Mapping Context comprising the SP/SO and that ENNI Service Mapping Identifier.

If an ENNI Service Mapping Identifier does not appear in the value of the ENNI Routing Information Service Attribute, the behavior is as if the AS Override parameter was *Disabled*.

#### 14.3.1.4 Static Routes

The Static Routes parameter for a given ENNI Service Mapping Identifier is a list of static routes over the ENNI for the service identified by that ENNI Service Mapping Identifier. The list can be empty. If the list is not empty, each entry in the list comprises the following three fields:

- IP Prefix: an IP Prefix reachable via the ENNI Links that are assigned (via the ENNI Service Map Common Attribute, section 15.6) to the ENNI Service Mapping Context comprising the SP/SO and that ENNI Service Mapping Identifier.
- Administrative Distance: an integer greater than 0.
- Target Role: either *Root* or *Leaf*, indicating whether this route is towards a root or a leaf IPVC End Point.

The Operator directs traffic destined for an address within any of the listed IP Prefixes towards the ENNI Links corresponding to the Service Mapping Identifier.

The administrative distance is a numeric metric used to control which routes are selected, when there are multiple routes for the same IP Prefix. A lower number indicates a more preferable route. The administrative distance is used by an LLO as described in section 15.5 and requirement [R207].

The target role indicates whether the route is towards an IPVC EP in the SP/SO's or a higher IPVC with Root role or Leaf role (see section 11.4). This affects how the route is distributed within the Operator's IPVC, as described in section 9.1.

If an ENNI Service Mapping Identifier does not appear in the value of the ENNI Routing Information Service Attribute, the behavior is as if the Static Routes parameter was an empty list.

### 14.4 ENNI Ingress Bandwidth Profile Envelopes Service Attribute

The ENNI Ingress Bandwidth Profile Envelopes Service Attribute applies when the ENNI Type Service Attribute (section 14.2) is *Option A*. The applicability when Option B or Option C are used at the ENNI is deferred to a future version of this specification.

The ENNI Ingress Bandwidth Profile Envelopes Service Attribute is a list (possibly empty) of pairs of (ENNI Service Mapping Identifier, Bandwidth Profile Envelope), where each Bandwidth Profile Envelope consists of parameters and Bandwidth Profile Flow specifications, as described in section 17.3. If an entry is specified for a given ENNI Service Mapping Identifier, a BWP Envelope with the given parameters and BWP Flows is used for an ingress Bandwidth Profile on each ENNI Link that is used to carry traffic for that ENNI Service Mapping Identifier. Note that the amount of bandwidth assigned by the Bandwidth Profile in total for ingress traffic at the ENNI is set by the parameters for the BWP Envelope multiplied by the number of ENNI Links assigned for the ENNI Service Mapping Identifier.

An Ingress Bandwidth Profile Envelope at an ENNI can be specified for either ENNI Links or an IPVC EP.

**[R190]** If the ENNI Ingress Bandwidth Profile Envelopes Service Attribute contains an entry for a given ENNI Service Mapping Identifier, the IPVC EP Ingress Bandwidth Profile Envelope Service Attribute (section 11.11) **MUST** be *None* for all IPVC EPs at the ENNI where the value of the IPVC EP ENNI Service Mapping Identifier Service Attribute (section 11.6) is that ENNI Service Mapping Identifier.

**[R191]** The ENNI Ingress Bandwidth Profile Envelopes Service Attribute **MUST NOT** contain more than one entry for a given ENNI Service Mapping Identifier.

## 14.5 ENNI Egress Bandwidth Profile Envelopes Service Attribute

The ENNI Egress Bandwidth Profile Envelopes Service Attribute applies when the ENNI Type Service Attribute (section 14.2) is *Option A*. The applicability when Option B or Option C are used at the ENNI is deferred to a future version of this specification.

The ENNI Egress Bandwidth Profile Envelopes Service Attribute is a list (possibly empty) of pairs of (ENNI Service Mapping Identifier, Bandwidth Profile Envelope), where each Bandwidth Profile Envelope consists of parameters and Bandwidth Profile Flow specifications, as described in section 17.3. If an entry is specified for a given ENNI Service Mapping Identifier, a BWP Envelope with the given parameters and BWP Flows is used for an egress Bandwidth Profile on each ENNI Link that is used to carry traffic for that ENNI Service Mapping Identifier. Note that the amount of bandwidth assigned by the Bandwidth Profile in total for egress traffic at the ENNI is set by the parameters for the BWP Envelope multiplied by the number of ENNI Links assigned for the ENNI Service Mapping Identifier.

An Egress Bandwidth Profile Envelope can be specified for either ENNI Links or an IPVC EP.

**[R192]** If the ENNI Egress Bandwidth Profile Envelopes Service Attribute contains an entry for a given ENNI Service Mapping Identifier, the IPVC EP Egress Bandwidth Profile Envelope Service Attribute (section 11.12) **MUST** be *None* for all IPVC EPs at the ENNI where the value of the IPVC EP ENNI Service Mapping Identifier Service Attribute (section 11.6) is that ENNI Service Mapping Identifier.

**[R193]** The ENNI Egress Bandwidth Profile Envelopes Service Attribute **MUST NOT** contain more than one entry for a given ENNI Service Mapping Identifier.

## 15 ENNI Common Attributes

This section specifies the Common Attributes that apply to each ENNI agreed between two LLOs. There is one instance of these attributes for each ENNI agreed between two LLOs, and the attributes are agreed between the LLOs, as described in section 8.3. Note that these attributes are not specific to a given SP/SO that uses the ENNI. The attributes are summarized in Table 22 and described in more detail in the following subsections.

Note that for some of the ENNI Common Attributes, a value needs to be agreed for each LLO at the ENNI; for example, when peering BGP, the value of each LLO’s AS Number needs to be agreed. In these cases, the LLOs are referred to as “First LLO” and “Second LLO”. The two LLOs must agree which is the first and which is the second when interpreting these attributes.

As described in section 8.4, an SO whose network terminates at an ENNI must also be the LLO at that ENNI. This is captured in the following requirement.

**[R194]** If an SO agrees on a service with an SP/SO that has an IPVC EP at an ENNI, the organization acting as the SO **MUST** be the same organization that acts as the LLO on the side of the ENNI where the IPVC EP is located.

Attribute Name	Summary Description	Possible Values
ENNI Peering Identifier	Unique identifier for the ENNI for management purposes.	Printable string that is unique across both LLOs’ networks.
ENNI Peering Type	Indication of the type of BGP Peering at the ENNI.	<i>Option A, Option B, Option C, or Options B and C.</i>
ENNI List of ENNI Links	List of ENNI Links in the ENNI.	List of 3-tuples of the form (Identifier, L1 Technology, List of ENNI Link identifiers).
ENNI List of Control Protocols	Indication of IP Control Protocols that are not forwarded transparently by the LLO.	See section 15.4.
ENNI Routing Protocols	List of Routing Protocols used across the ENNI.	See section 15.5.
ENNI Service Map	Mapping of ENNI Service Mapping Contexts across the ENNI.	For Option A, a map of ENNI Service Mapping Contexts to sets of ENNI Link Identifiers.

**Table 22 – ENNI Common Attributes**

### 15.1 ENNI Peering Identifier Common Attribute

The ENNI Peering Identifier Common Attribute is a unique string identifier for the ENNI. It can be used by the two LLOs creating an ENNI to identify the ENNI to each other.

**[R195]** The ENNI Peering Identifier **MUST** consist only of ASCII characters in the range 32-126 inclusive.

- [R196] The length of the ENNI Peering Identifier **MUST** be less than or equal to 53 characters.
- [R197] The value of the ENNI Peering Identifier **MUST** be unique among all such identifiers for ENNIs supported by each Operator.

## 15.2 ENNI Peering Type Common Attribute

The ENNI Peering Type Common Attribute indicates the type of BGP Peering used across the ENNI. The possible values are *Option A*, *Option B*, *Option C*, or *Options B and C*. These refer to the options described in RFC 4364 [31], and summarized in section 8.6.

Note that requirements and behaviors for values other than *Option A* are deferred and may be addressed in a future version of this specification.

## 15.3 ENNI List of ENNI Links Common Attribute

The ENNI List of ENNI Links Common Attribute is a list of 3-tuples of the form (*ID*, *L1*, *Links*). Each entry in the list corresponds to a distinct L1 link across the ENNI – in most cases, this means a separate physical link (although virtual or logical links are not precluded). The first element in the 3-tuple, *ID*, is the identifier of the L1 link. The second element, *L1*, contains the details of the L1 technology used for the link. The third element, *Links*, is a list (possibly empty) of ENNI Link Identifiers (see section 16.1) for the ENNI Links in this ENNI that traverse the L1 link. Each element is described in the subsections below; the final subsection gives some examples.

- [R198] The L1 Links listed in the ENNI List of ENNI Links Common Attribute **MUST** all be connected between the same pair of LLOs.

Note that a given L1 link does not need to be dedicated to a single ENNI. In other words, ENNI Links for multiple ENNIs can be carried over the same L1 link between two LLOs. In this case, the L1 Links would be listed in the ENNI List of ENNI Links Common Attribute for each ENNI. One reason to do this would be to allow for different ENNI properties; for instance, some ENNI Links may carry services peered using Option A, and others Option B. These links would need to be assigned to different ENNIs, but could be carried on the same underlying L1 link.

### 15.3.1 L1 Link Identifier

The L1 Link Identifier, *ID*, is a unique string identifier for the L1 Link.

- [R199] The value of *ID* in the ENNI List of ENNI Links Common Attribute **MUST** consist only of ASCII characters in the range 32-126 inclusive.
- [R200] The length of *ID* in the ENNI List of ENNI Links Common Attribute **MUST** be less than or equal to 53 characters.
- [R201] The value *ID* in the ENNI List of ENNI Links Common Attribute **MUST** be unique among all such identifiers for ENNIs supported by each Operator.



**[R202]** A given value of value *ID* **MUST** appear at most once in the value of the ENNI List of ENNI Links Common Attribute.

### 15.3.2 L1 Technology

The L1 Technology parameter, *L1*, describes the properties of the underlying L1 connection across the ENNI. There are many possible ways to connect at Layer 1, and hence the details of this parameter are beyond the scope of this document. Nevertheless some guidance is given below.

L1 links at an ENNI are always point to point, connecting one LLO to another. Typically, this is done with physical links, in which case the details of the physical links are specified in this parameter. For example, if the links are Ethernet, the type of Ethernet PHY needs to be specified, or if the links are SONET/SDH, the speed/type (e.g. OC48) needs to be specified.

More complex possibilities, which are not strictly contained in Layer 1, are also possible. For example, the connection across an ENNI could use an Ethernet Link Aggregation Group containing several physical Ethernet links.

In general, sufficient parameters need to be specified to describe the responsibility of the each LLO to the other. Anything which is entirely within one LLOs domain and is not visible to the other LLO does not need to be specified. For example, if the L1 Link is a physical Ethernet link, then the attributes of the link need to be specified, but what is connected to each LLO's end of the link does not. An LLO could connect their ASBR (Autonomous System Border Router, see RFC 4364 [31]) directly to the physical Ethernet connection, or they might carry the IP Packets over an intervening Ethernet access network before they reach the ASBR. As this is opaque to the other LLO, it does not need to be specified.

Table 23 lists some examples of L1 technologies that could be used at an ENNI, in cases where the L1 Link is a single physical connection. Note that this list is provided for information only and is not intended to be exhaustive. Other types of L1 technology than those listed in the table can be used in this Service Attribute.

Technology Type	Technology
Ethernet (10Mb/s)	10BASE-T 10BASE-FP 10BASE-FB 10BASE-FL
Ethernet (100Mb/s)	100BASE-T 100BASE-T4 100BASE-X 100BASE-T2
Ethernet (1Gb/s)	1000BASE-X 1000BASE-T 1000BASE-SX 1000BASE-LX 1000BASE-CX

Technology Type	Technology
Ethernet (10Gb/s)	10GBASE-W 10GBASE-SR 10GBASE-LR 10GBASE-ER 10GBASE-LX4 10GBASE-SW 10GBASE-LW 10GBASE-EW 10GBASE-KR 10GBASE-KX4 10GBASE-T 10GBASE-LRM 10GBASE-CX4 10GBASE-PR-D1 10GBASE-PR-D2 10GBASE-PR-D3 10GBASE-PR-D4 10GBASE-PR-U1 10GBASE-PR-U2 10GBASE-PR-U3 10GBASE-PR-U4 10/1GBASE-PRX-D1 10/1GBASE-PRX-D2 10/1GBASE-PRX-D3 10/1GBASE-PRX-D4 10/1GBASE-PRX-U1 10/1GBASE-PRX-U2 10/1GBASE-PRX-U3 10/1GBASE-PRX-U4
Ethernet (40Gb/s)	40GBASE-ER4 40GBASE-FR 40GBASE-LR4 40GBASE-SR4 40GBASE-CR4 40GBASE-KR4
Ethernet (100Gb/s)	100GBASE-CR4 100GBASE-KR4 100GBASE-KP4 100GBASE-ER4 100GBASE-LR4 100GBASE-SR10 100GBASE-CR10 100GBASE-SR4

Technology Type	Technology
Fiber Channel	FC-100 (1.0625 Gb/s) FC-200 (2.125 Gb/s) FC-400 (4.250 Gb/s) FC-800 (8.500 Gb/s) FC-1200 (10.51875 Gb/s) FC-1600 (14.025 Gb/s) FC-3200 (28.05 Gb/s)
SDH	STM-1 STM-4 STM-16 STM-64 STM-256
SONET	OC-3 OC-12 OC-48 OC-192 OC-768

**Table 23 – Examples of L1 Technologies**

### 15.3.3 List of ENNI Links

An ENNI Link is an IP subnetwork corresponding to a distinct IP subnet (which might use both IPv4 and IPv6 addressing), and consisting of a single IP hop from a service perspective (i.e., there is no intermediate router that processes the IP Packets traversing the link (see section 7.3)). Each ENNI Link traverses one of the L1 Links that the ENNI comprises.

**[R203]** An ENNI Link **MUST** belong to exactly one L1 Link at exactly one ENNI.

A corollary of [R198] is that all of the ENNI Links listed in the ENNI List of ENNI Links Common Attribute are connected between the same pair of LLOs.

Note that the L2 technology used to distinguish traffic between different ENNI Links that share the same underlying L1 Link is specified in the ENNI Link L2 Technology Attribute (section 16.2).

### 15.3.4 Example

Consider an ENNI formed of two physical 10G Ethernet links. Two logical ENNI Links have been created over each of the physical links. In this case, the value of the ENNI List of ENNI Links Common Attribute might be as follows:

```
[ ( ID: "ABC.XYZ.Link01",
  LI: "Ethernet 10GBASE-SR",
  Links: [ "ABC.XYZ.ENNILink.01.01", "ABC.XYZ.ENNILink.01.02" ] ),
 ( ID: "ABC.XYZ.Link02",
  LI: "Ethernet 10GBASE-SR",
```

*Links:* [ “ABC.XYZ.ENNILink.02.01”, “ABC.XYZ.ENNILink.02.02” ] ]

A different case is where the ENNI consists of two physical 10G Ethernet links that are placed into a LAG. Two ENNI Links are created over the LAG. In this case, the value of the ENNI List of ENNI Links Common Attribute might be as follows:

[ ( *ID:* “ABC.XYZ.Link01”,  
*LI:* “LAG containing two Ethernet links with PHY 10GBASE-SR”,  
*Links:* [ “ABC.XYZ.ENNILink.01.01”, “ABC.XYZ.ENNILink.01.02” ] ) ]

#### 15.4 ENNI List of Control Protocols Common Attribute

The ENNI List of Control Protocols Common Attribute is a list of control protocols, along with corresponding addressing and references, that identifies packets that are IP Control Protocol Packets rather than IP Data Packets. Each entry in the list consists of a pair containing the protocol name and one or more references.

Any IP Packet matching an entry in the list is considered to be an IP Control Protocol Packet. Ingress IP Control Protocol Packets are not forwarded across the IPVC (i.e., the packet delivery requirements and packet transparency requirements in section 10.4 do not apply); they are either peered or discarded. Egress IP Control Protocol Packets are generated within the Operator Network.

An Ingress IP Packet at an ENNI matches an entry in the list if it is for the specified protocol and has a multicast or broadcast destination address, or a unicast destination address that is reachable within the receiving LLO’s network. An Egress IP Packet at an ENNI matches an entry in the list if it is for the specified protocol and has a source address that is reachable within the transmitting LLO’s network.

Delivery of multicast Ingress IP Packets across the IPVC is outside the scope of this specification (and could be addressed in a future version); hence all multicast IP Packets for the specified protocols are considered to be IP Control Protocol Packets.

Any IP Packets that cross the ENNI that are not considered to be IP Control Protocol Packets are IP Data Packets, and hence the packet delivery and packet transparency requirements in section 10.4 apply.

Each entry in the ENNI List of Control Protocols includes a reference to a standard or other specification that describes how packets belonging to the protocol are identified.

An example of the ENNI List of Control Protocols Common Attribute is shown in Table 24.

Protocol	Reference
ICMP	IETF RFC 792
BGP	IETF RFC 4271

**Table 24 – Example value of the ENNI List of Control Protocols Common Attribute**

In this example, BGP is used over the ENNI, and the LLOs also allow each other to ping their internal addresses with ICMP. All other protocols are treated as IP Data Packets.

Note that although multicast routing is outside the scope of this specification, control protocols related to multicast routing (e.g. IGMP, MLD, and PIM) can be included in the list of control protocols. This can be useful if an LLO wishes to discard all IP Packets relating to such protocols, to ensure they do not disrupt the operation of their networks.

**[R204]** An Ingress IP Packet that matches an entry in the ENNI List of Control Protocols Common Attribute **MUST NOT** be delivered as an Egress IP Packet at any EI.

Note that if a protocol is peered, an Ingress IP Packet might result in a different IP Packet being sent in response. [R204] means that an Ingress IP Packet cannot result in an unmodified (other than as described in section 9.4) Egress IP Packet.

**[O26]** IP Control Protocol Packets **MAY** be peered or discarded by the receiving LLO.

Whether a protocol is peered or discarded is at the discretion of the receiving LLO; but some protocols have to be peered if they correspond with attributes that have been agreed.

**[R205]** The following protocols **MUST** be included in the ENNI List of Control Protocols if they are enabled per the corresponding attributes as shown below:

- BGP: ENNI Routing Protocols Common Attribute (section 15.5).
- BFD: ENNI Link BFD Attribute (section 16.5) for any ENNI Link in the ENNI.
- ICMP: IPVC Path MTU Discovery Service Attribute (section 10.11) for any IPVC attached to the ENNI.

For convenience, references for some common IP Control Protocols are given in Table 19 (section 12.6) – these might or might not be included in the ENNI List of Control Protocols for a given ENNI.

## 15.5 ENNI Routing Protocols Common Attribute

The ENNI Routing Protocols Common Attribute specifies the routing protocols and associated parameters that are used to exchange IP routes across the ENNI. The details of this attribute depend on the value of the ENNI Peering Type Common Attribute (section 15.2). When the ENNI Peering Type Common Attribute is *Option A*, the values and requirements of this attribute are described in section 15.5.1. The values and requirements for other cases are deferred to a future version of this specification.

### 15.5.1 ENNI Routing Protocols for Option A

For an ENNI using Option A, the ENNI Routing Protocols Common Attribute is a non-empty list of protocols, where each entry consists of the protocol name (always *BGP*), the type of routes that

will be exchanged (one of *IPv4*, *IPv6* or *Both*), and a set of additional parameters as specified in the subsections below.

- [R206]** The value of the ENNI Routing Protocols Common Attribute **MUST NOT** contain more than one entry for the same protocol name, except when there are exactly two entries with a given protocol name, one with route type *IPv4* and one with route type *IPv6*.

Note that regardless of the routing protocol in use, an LLO directs traffic destined for an address within the IP Prefixes identified by the ENNI Link IPv4 Connection Addressing Attribute (see section 16.3) and the ENNI Link IPv6 Connection Addressing Attribute (see section 16.4) towards the corresponding ENNI Link, as described in section 9.

The ENNI Routing Protocols Common Attribute applies to all ENNI Links in an ENNI. If there are multiple ENNI Links connecting two LLOs and it is desired to use different routing protocols or parameters on different ENNI Links, the ENNI Links can be assigned to different ENNIs, as described in section 8.2.

The SP/SO agrees on an administrative distance value for each ENNI Service Mapping Identifier, with each LLO, as described in section 14.3. This is a numeric metric used to control which routes are selected, when there are multiple routes for the same IP Prefix. A lower number indicates a more preferable route. The value agreed between the SP/SO and an LLO for a given ENNI Service Mapping Identifier is applied to all BGP routes advertised by the other LLO over the ENNI Links assigned to that ENNI Service Mapping Identifier. For the purpose of this specification, IP Prefixes identified by the ENNI Link IPv4 Connection Addressing Attribute (see section 16.3) and the ENNI Link IPv6 Connection Addressing Attribute (see section 16.4) are considered to have administrative distance of 0, and for an IPVC EP at a given ENNI, routes towards other IPVC EPs for the IPVC are considered to have administrative distance 200. If routes are received from the other LLO over an ENNI Link that is assigned to a given ENNI Service Mapping Identifier, and that ENNI Service Mapping Identifier does not appear in the ENNI Routing Information Service Attribute (section 14.3), the routes are considered to have administrative distance 20.

- [R207]** When selecting the best route for packet delivery as described in section 9, an LLO **MUST** prefer routes with a lower administrative distance.

Note that the administrative distance values used in this document and specified in the value of the ENNI Routing Protocols Common Attribute are only related to each other, to specify the relative preference of routes. They might or might not correspond with administrative distance values actually used in the LLO's devices to implement the behavior.

For BGP, setting a different administrative distance for different IP Prefixes is not supported in this version of the specification.

In addition to routing protocols, static routes can be used over the ENNI, as described in section 14.3. If the Operator has agreed static routes for a given ENNI Service Mapping Identifier with the SP/SO via the ENNI Routing Information Service Attribute (section 14.3), the Operator directs traffic for those IP Prefixes over the operational ENNI Links that are assigned to the ENNI Service Mapping Context comprising the SP/SO and that ENNI Service Mapping Identifier.

### 15.5.1.1 BGP

When an entry in the ENNI Routing Protocols is for *BGP*, BGP as specified in RFC 4271 [29] is used across the ENNI to exchange routing information. Each LLO uses BGP to advertise IP Prefixes that are reachable over the ENNI to the other LLO, which consequently directs traffic destined for any IP address within those IP Prefixes towards the ENNI Link(s) corresponding to the nexthop associated with the IP Prefix.

Note: this section describes the use of BGP when the ENNI Peering Type Common Attribute is *Option A*. Requirements and behavior when the ENNI Peering Type is not *Option A* are deferred to a future version of this specification.

The additional parameters that need to be agreed when BGP is used are:

- First LLO's AS Number.
- Second LLO's AS Number.
- Connection Address Family (*IPv4* or *IPv6*).
- Authentication (*None* or *MD5* plus a password).
- First LLO's BGP Community List (see below).
- First LLO's BGP Extended Community List (see below).
- Second LLO's BGP Community List (see below).
- Second LLO's BGP Extended Community List (see below).
- Hold Time (time in seconds).
- First LLO's Route Marking for Leaves (see below).
- Second LLO's Route Marking for Leaves (see below).

Note that there are also further parameters that affect BGP operation across an ENNI, described in section 14.3.

The two LLOs' AS Numbers are used to establish BGP peerings. A separate BGP session is established over each ENNI Link, using the primary IPv4 addresses in the ENNI Link IPv4 Connection Addressing Attribute (section 16.3) or the first IPv6 addresses in the ENNI Link IPv6 Connection Addressing Attribute (section 16.4), as indicated by the Connection Address Family parameter. These peering sessions are single-hop eBGP connections. Note in this case that the same values for the parameters above apply to each of these BGP peering sessions; if this is not desired, the ENNI Links can be assigned to different ENNIs.

**[R208]** If an entry in the ENNI Routing Protocols list for *BGP* has Connection Address Family set to *IPv4*, the ENNI Link IPv4 Connection Addressing Attribute (section 16.3) **MUST** be *Static* at every ENNI Link in the ENNI.

**[R209]** If an entry in the ENNI Routing Protocols list for *BGP* has Connection Address Family set to *IPv6*, the ENNI Link IPv6 Connection Addressing Attribute (section 16.4) **MUST** be *Static* at every ENNI Link in the ENNI.

**[R210]** When an entry in the ENNI Routing Protocols is for *BGP*, both LLOs **MUST** support 4-octet AS Numbers as described in RFC 6793 [47].

- [R211] When an entry in the ENNI Routing Protocols is for *BGP*, if the Authentication parameter is *MD5*, authentication using MD5 **MUST** be used as described in RFC 4271 [29] using the specified password.

Note that RFC 4271 [29] mandates support for MD5 passwords in BGP implementations.

- [R212] When an entry in the ENNI Routing Protocols is for *BGP*, the LLOs **MUST NOT** use passive TCP establishment for BGP sessions with each other.

BGP Communities and Extended Communities allow additional metadata to be attached to route advertisements. Except in the case of the few standardized well-known values, this additional metadata has no intrinsic meaning. However, it is common for LLOs to define a set of Communities or Extended Communities with associated semantics, that the other LLO at the ENNI can attach to their route advertisements in order to affect how they are handled by the receiving LLO.

- [R213] The First LLO's BGP Community List and First LLO's BGP Extended Community List parameters **MUST** only contain values that are allocated by the First LLO as described in RFC 1997 [6] and RFC 4360 [30].
- [R214] The Second LLO's BGP Community List and Second LLO's BGP Extended Community List parameters **MUST** only contain values that are allocated by the Second LLO as described in RFC 1997 [6] and RFC 4360 [30].
- [R215] Each entry in the BGP Community List and BGP Extended Community List parameters **MUST** have an associated semantic that describes how the defining LLO will handle routes advertised to them with that value.

The Hold Time parameter indicates the agreed Hold Time used for the BGP sessions. The possible values are 0 or an integer in the range 3 – 65535, as defined in RFC 4271 [29].

As described in sections 8.7 and 9.2, when routes are advertised across an ENNI, they may need to be marked to indicate whether they will direct traffic towards an IPVC EP that has Root role or one that has Leaf role (see section 11.4). To enable this, each LLO specifies the marking that the other LLO is to use when advertising routes for leaves across the ENNI, using the Route Marking for Leaves parameters (i.e., the marking is specified by the LLO receiving the routes). Routes that do not have this marking can be assumed to be for roots.

For ENNIs using Option A, the exact form of marking is outside the scope of this document, and must be agreed between the LLOs. For example, a particular BGP Community or BGP Extended Community value could be used.

## 15.6 ENNI Service Map Common Attribute

The details of this attribute depend on the value of the ENNI Peering Type Common Attribute (section 15.2). When the ENNI Peering Type Common Attribute is *Option A*, the values and requirements of this attribute are described in section 15.6.1. The values and requirements for other cases are deferred to a future version of this specification.



### 15.6.1 ENNI Service Map for Option A

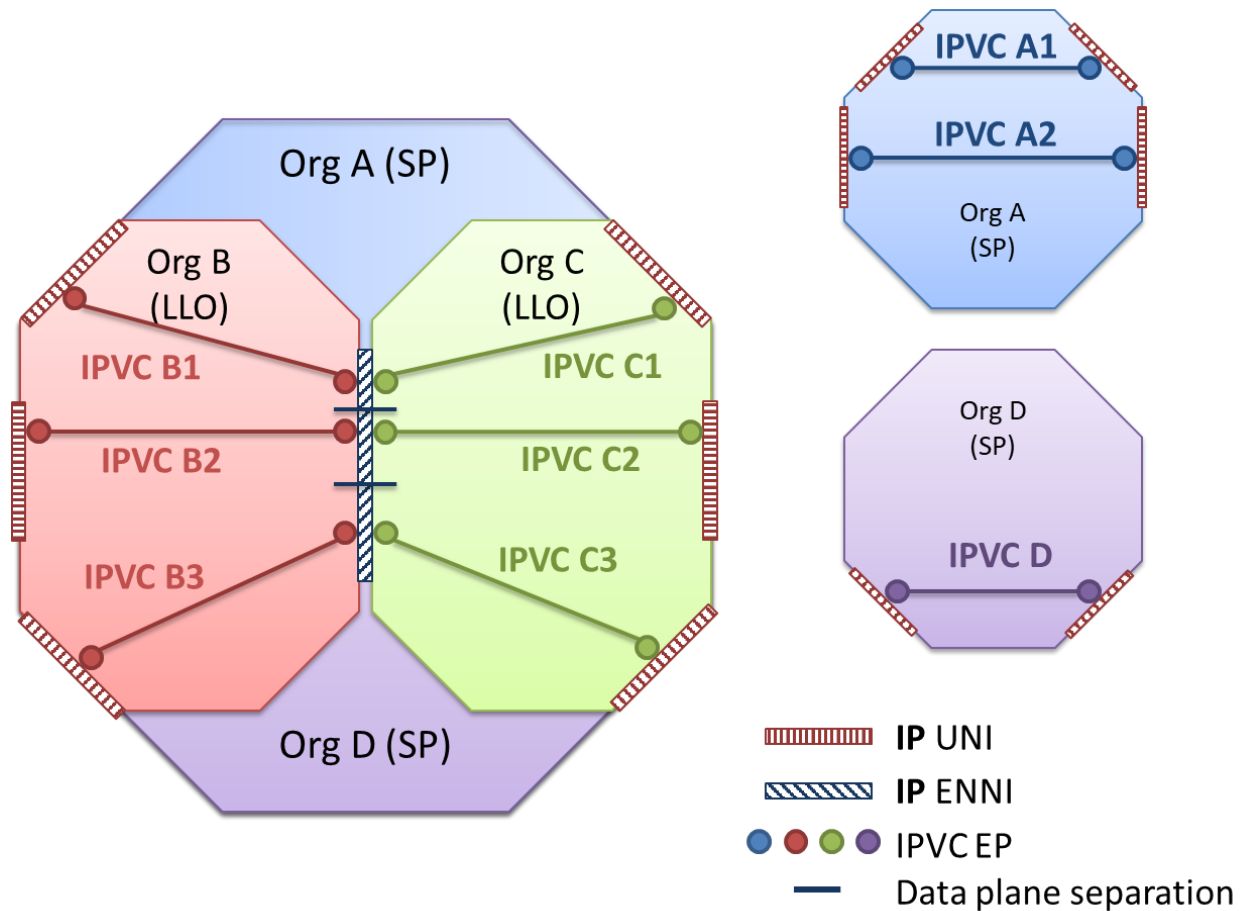
For an ENNI using Option A, the ENNI Service Map Common Attribute is a mapping from ENNI Service Mapping Contexts to sets of ENNI Link Identifiers for ENNI Links in the ENNI.

As described in section 8.6, an ENNI Service Mapping Context is a pair of (SP/SO, ENNI Service Mapping Identifier), i.e. it uniquely identifies services for a given SP/SO on either side of the ENNI that have been assigned the same ENNI Service Mapping Identifier, and hence need to be connected to each other. An SP/SO implementing a service across an ENNI using IPVCs from the two Operators on either side of the ENNI assigns an ENNI Service Mapping Identifier to each IPVC EP at the ENNI via the IPVC EP ENNI Service Mapping Identifier Service Attribute (section 11.6), such that the IPVC EPs on either side of the ENNI that need to be connected so as to realize the end-to-end service have the same ENNI Service Mapping Identifier. For an ENNI using Option A, the two Operators (which must both be LLOs per [R194]) can then map each such ENNI Service Mapping Context to a set of ENNI Links, using the ENNI Service Map Common Attribute. An example is shown in section 8.6.

- [R216] If an Operator has an IPVC EP for a given SP/SO at an ENNI using Option A, the ENNI Service Mapping Context formed by pairing that SP/SO and the value of the IPVC EP ENNI Service Mapping Identifier (section 11.6) for that IPVC EP **MUST** be included in the value of the ENNI Service Map Common Attribute at the ENNI.
- [R217] An entry in the ENNI Service Map Common Attribute for an ENNI using Option A **MUST** map each ENNI Service Mapping Context to one or more ENNI Link Identifiers that are included in the ENNI List of ENNI Links Common Attribute (section 15.3) for that ENNI.
- [R218] A given ENNI Link Identifier **MUST NOT** appear in more than one entry in the ENNI Service Map Common Attribute.

It is up to the two LLOs to determine how many ENNI Links each ENNI Service Mapping Context is mapped to, so that they can both meet their respective SLS performance objectives. Note that since the ENNI is defined to be the demarcation of responsibility between the two LLOs, the physical links by which they are connected are one side or the other of the ENNI, depending on which LLO is responsible for them.

As an example of the ENNI Service Map Common Attribute, consider the situation depicted in Figure 30.



**Figure 30 – Example for ENNI Service Map**

In this example Organization A (acting as an SP) provides two Subscriber IPVCs, each between two UNIs, and Organization D (acting as an SP) provides a Subscriber IPVC between two other UNIs, as shown in the small figures on the right. Both A and D implement their respective IPVCs by using Operator IPVCs from Organizations B and C. Service Provider A uses IPVCs B1 and B2 from Operator B, and IPVCs C1 and C2 from Operator C. Service Provider D uses IPVC B3 from Operator B and IPVC C3 from Operator C.

There are six IPVC EPs at the ENNI, for IPVCs B1, B2, B3, C1, C2, and C3. Suppose Service Provider A agrees the ENNI Service Mapping Identifier “foo” with each Operator for IPVC EPs B1 and C1, and ENNI Service Mapping Identifier “bar” for IPVC EPs B2 and C2. Suppose Service Provider D agrees ENNI Service Mapping Identifier “bar” with each Operator for IPVCs B3 and C3.

Suppose the ENNI comprises five ENNI Links. Then Operators B and C might agree on a value of the ENNI Service Map Common Attribute that maps (A, “foo”) to ENNI Link 1, (A, “bar”) to ENNI Links 2 and 3, and (D, “bar”) to ENNI Links 4 and 5, as shown in Table 25.

ENNI Service Mapping Context	ENNI Links
(A, “foo”)	1
(A, “bar”)	2, 3
(D, “bar”)	4, 5

**Table 25 – Example value of the ENNI Service Map Common Attribute**

Note that ENNI Service Mapping Identifier “bar” is used by both SP A and SP D; this is why the ENNI Service Mapping Context, which includes an identifier for the SP/SO, must be used in the ENNI Service Map Common Attribute.

The attributes described in this example are summarized in Table 26.

Attribute	Value	Agreed between
IPVC EP ENNI Service Mapping Identifier (IPVC EP for B1)	“foo”	SP A and LLO B
IPVC EP ENNI Service Mapping Identifier (IPVC EP for B2)	“bar”	SP A and LLO B
IPVC EP ENNI Service Mapping Identifier (IPVC EP for B3)	“bar”	SP D and LLO B
IPVC EP ENNI Service Mapping Identifier (IPVC EP for C1)	“foo”	SP A and LLO C
IPVC EP ENNI Service Mapping Identifier (IPVC EP for C2)	“bar”	SP A and LLO C
IPVC EP ENNI Service Mapping Identifier (IPVC EP for C3)	“bar”	SP D and LLO C
ENNI Service Map	See Table 25	LLO B and LLO C

**Table 26 – Attribute Summary for ENNI Service Map Example**

## 16 ENNI Link Attributes

This section specifies the ENNI Link Attributes that apply to each ENNI Link agreed between two LLOs. There is one instance of these attributes for each ENNI Link agreed between two LLOs, and the attributes are agreed between the LLOs, as described in section 8.3. Note that these attributes are not specific to a given SP/SO that uses the ENNI. The attributes are summarized in Table 27 and described in more detail in the following subsections.

Note that an ENNI Link is a logical link consisting of a single IP hop, over which IP traffic can be passed; it is not necessarily a distinct physical connection. See sections 8.2 and 15.3.

Attribute Name	Summary Description	Possible Values
ENNI Link Identifier	Unique identifier for the ENNI Link for management purposes.	Printable string that is unique across both LLOs' networks.
ENNI Link L2 Technology	Describes the underlying L2 technology for the ENNI Link.	See section 16.2.
ENNI Link IPv4 Connection Addressing	IPv4 Connection Addressing.	<i>None</i> or <i>Static</i> plus associated parameters.
ENNI Link IPv6 Connection Addressing	IPv6 Connection Addressing.	<i>None</i> , <i>Static</i> or <i>LL-only</i> plus associated parameters.
ENNI Link BFD	Indication of whether BFD is used on the ENNI Link.	<i>None</i> , or a set of parameters as described in section 16.5.
ENNI Link IP MTU	Maximum size, in octets, of an IP Packet that can traverse the ENNI Link.	Integer $\geq 576$ .

**Table 27 – ENNI Link Attributes**

### 16.1 ENNI Link Identifier Attribute

The ENNI Link Identifier Attribute is a unique string identifier for the ENNI Link. It can be used by the two LLOs connected by an ENNI Link to identify the ENNI Link to each other.

- [R219] The ENNI Link Identifier **MUST** consist only of ASCII characters in the range 32-126 inclusive.
- [R220] The length of the ENNI Link Identifier **MUST** be less than or equal to 53 characters.
- [R221] The value of the ENNI Link Identifier **MUST** be unique among all such identifiers for ENNI Links supported by each LLO.

### 16.2 ENNI Link L2 Technology Attribute

The ENNI Link L2 Technology Attribute describes the underlying Layer 2 that carries IP Packets across the ENNI. The fundamental property of an ENNI Link is to be able to convey IP Packets

between two LLOs; however, there are many possible ways to do this, and hence the details of this attribute are beyond the scope of this document. Nevertheless some guidance is given below.

ENNI links are always logically point to point; that is, they provide an L3 link between, conceptually, a single L3 interface in one LLO and a single L3 interface in the other LLO. Common L2 technologies at an ENNI include Ethernet (including VLANs), Point-to-Point Protocol (PPP), and Resilient Packet Ring (RPR); however other technologies can also be used.

This attribute includes the details of the immediately-lower network layer, which always need to be agreed and hence specified in this attribute. Typically any lower layers that need to be specified are described in the *LI* parameter of the ENNI List of ENNI Links Common Attribute (section 15.3). For example, if the ENNI Link is a VLAN on a physical Ethernet Link, then the VLAN ID needs to be specified in this attribute, but the details of the physical link are contained in the ENNI List of ENNI Links Common Attribute.

In general, sufficient parameters need to be specified to describe the responsibility of the each LLO to the other. Anything which is entirely within one LLOs domain and is not visible to the other LLO does not need to be specified.

Some examples of the UNI Access Link L2 Technology Service Attribute can be found in section 13.3. These also apply to ENNIs, with the exception that only the L2 details are included in the ENNI Link L2 Technology Attribute, and the details of the physical links are included in the ENNI List of ENNI Links Common Attribute (section 15.3).

### 16.3 ENNI Link IPv4 Connection Addressing Attribute

The ENNI Link IPv4 Connection Addressing specifies how IPv4 addresses are allocated to the devices connected to the ENNI Link. It is either *None* or *Static*, plus in the case of *Static*, some additional parameters.

If the IPv4 Connection Addressing is *None*, no IPv4 addresses are used by the devices connected to the ENNI Link and IPv4 is disabled on the link. Note that in this case IPv6 connection addresses are needed.

**[R222]** The ENNI Link IPv4 Connection Addressing Attribute and the ENNI Link IPv6 Connection Addressing Attribute (section 16.4) **MUST NOT** both have the value *None*.

If the IPv4 Connection Addressing is *Static*, then IPv4 addresses in a given IPv4 subnet are statically assigned to each LLO. In this case, a number of further parameters have to be agreed:

- Primary Subnet:
  - IPv4 Prefix (IPv4 address prefix and mask length between 0 and 31, in bits).
  - First LLO IPv4 Address (IPv4 address).
  - Second LLO IPv4 Address (IPv4 address).
- Secondary Subnet List; each entry containing:
  - IPv4 Prefix (IPv4 address prefix and mask length between 0 and 31, in bits).
  - First LLO IPv4 Address (IPv4 address).

- Second LLO IPv4 Address (IPv4 address).

The parameters consist of a primary subnet and zero or more secondary subnets. In each case, the IP Prefix is specified, along with the two LLO's IPv4 addresses. In the case of the primary subnet, this IP Prefix is referred to as the Connection Primary IPv4 Prefix, and for a secondary subnet, the Connection Secondary IPv4 Prefix.

When Static addressing is used, the LLO's addresses are assumed to also be the ASBR addresses, which are used to form BGP peerings.

**[R223]** If the IPv4 Connection Addressing is *Static*, for the Primary Subnet and for each Secondary Subnet, the two LLOs' IPv4 Addresses **MUST** be within the specified IPv4 Prefix.

**[R224]** If the IPv4 Connection Addressing is *Static*, for the Primary Subnet and for each Secondary Subnet, the two LLOs' IPv4 Addresses **MUST** be different to each other.

#### 16.4 ENNI Link IPv6 Connection Addressing Attribute

The ENNI Link IPv6 Connection Addressing specifies how IPv6 addresses are allocated to the devices connected to the ENNI Link. It is one of the three values *None*, *Static* or *LL-only*, plus in the case of *Static*, some additional parameters.

If the IPv6 Connection Addressing is *None*, no IPv6 addresses are used by the devices connected to the ENNI Link and IPv6 is disabled on the link. Note that in this case IPv4 connection addresses are needed (see [R222]).

If the IPv6 Connection Addressing is not *None*, then IPv6 link local addresses are used on the ENNI Link. If the value is *LL-only*, these are the only IPv6 addresses used on the ENNI Link.

If the IPv6 Connection Addressing is *Static*, then IPv6 addresses in a given IPv6 subnet are statically assigned to the two LLOs. In this case, a number of further parameters have to be agreed:

- Subnet List of one or more subnets, each comprising:
  - IPv6 Prefix (IPv6 address prefix and mask length between 0 and 127, in bits).
  - First LLO IPv6 Address (IPv6 address).
  - Second LLO IPv6 Address (IPv6 address).

The parameters consist of a list of one or more subnets. For each subnet, the IPv6 prefix and the two LLOs' IPv6 address are specified. The IPv6 Prefix is referred to as the Connection IPv6 Prefix.

When Static addressing is used, the LLO's addresses are assumed to also be the ASBR addresses, which are used to form BGP peerings.

**[R225]** If the IPv6 Connection Addressing is *Static*, for each entry in the Subnet List, the two LLOs' IPv6 Addresses **MUST** be within the Connection IPv6 Prefix for that entry.

- [R226] If the IPv6 Connection Addressing is *Static*, for each entry in the Subnet List, the two LLOs' IPv6 Addresses **MUST** be different to each other.

## 16.5 ENNI Link BFD Attribute

The ENNI Link BFD Attribute indicates whether Bidirectional Forwarding Detection (BFD) is enabled on the ENNI Link, and if so the parameters that need to be agreed. It is either *None* or a set of parameters consisting of:

- Connection Address Family (*IPv4*, *IPv6* or *Both*).
- Transmission Interval (time in ms).
- Detect Multiplier (integer).
- Authentication Type (*None*, *Simple Password*, *Keyed MD5*, *Meticulous Keyed MD5*, *Keyed SHA1*, *Meticulous Keyed SHA1*).

Note that although BFD implementations often have many configurable parameters, the above parameters are restricted to those that need to be agreed between the two LLOs in order to operate BFD across the ENNI Link.

The Connection Address Family parameter specifies whether the session is established over IPv4 or IPv6, or whether two separate sessions are established using IPv4 and IPv6. The sessions are established using the addresses in the ENNI Link IPv4 Connection Addressing Attribute (section 16.3) or the ENNI Link IPv6 Connection Addressing Attribute (section 16.4).

- [R227] When the ENNI Link BFD Attribute is not *None* and the Connection Address Family parameter is *IPv4* or *Both*, the ENNI Link IPv4 Connection Addressing Attribute (section 16.3) **MUST** be *Static*.
- [R228] When the ENNI Link BFD Attribute is not *None* and the Connection Address Family parameter is *IPv4* or *Both*, BFD as specified in RFC 5880 [44] and RFC 5881 [45], or where applicable, as specified in RFC 7130 [50], **MUST** be enabled using the Primary Subnet IPv4 addresses specified in the ENNI Link IPv4 Connection Addressing Attribute (section 16.3).
- [R229] When the ENNI Link BFD Attribute is not *None* and the Connection Address Family parameter is *IPv6* or *Both*, the ENNI Link IPv6 Connection Addressing Attribute (section 16.4) **MUST NOT** be *None*.
- [R230] When the ENNI Link BFD Attribute is not *None* and the Connection Address Family parameter is *IPv6* or *Both*, BFD as specified in RFC 5880 [44] and RFC 5881 [45], or where applicable, as specified in RFC 7130 [50], **MUST** be enabled using the IPv6 addresses for the first entry in the Subnet List specified in the ENNI Link IPv6 Connection Addressing Attribute (section 16.4), if the ENNI Link IPv6 Connection Addressing Attribute is *Static*.
- [R231] When the ENNI Link BFD Attribute is not *None* and the Connection Address Family parameter is *IPv6* or *Both*, BFD as specified in RFC 5880 [44] and RFC

5881 [45], or where applicable, as specified in RFC 7130 [50], **MUST** be enabled using the IPv6 link local addresses on the ENNI Link if the ENNI Link IPv6 Connection Addressing Attribute (section 16.4) is not *Static*.

BFD has two operating modes: asynchronous mode, and demand mode. As described in RFC 5880 [44], BFD sessions are initially established in asynchronous mode; thereafter, either peer can independently switch to demand mode. As this is negotiated in-band within the protocol, there is nothing that needs to be agreed beforehand between the two LLOs.

**[R232]** If an LLO supports a value for the ENNI Link BFD Attribute other than *None*, they **MUST** support asynchronous mode.

**[O27]** If an LLO supports a value for the ENNI Link BFD Attribute other than *None*, they **MAY** support demand mode.

BFD allows for asymmetrical operation, where packets can be sent at different intervals in each direction, and a different detect multiplier can be used. For simplicity, this specification mandates symmetrical operation.

**[R233]** When the ENNI Link BFD Attribute is not *None*, the Desired Minimum Transmit Interval and the Required Minimum Receive Interval **MUST** be set to the specified Transmission Interval in normal operation.

**[O28]** A longer transmission interval **MAY** be used during abnormal periods.

Optional Requirement [O28] allows for implementations that adjust the interval temporarily to keep the session up in certain cases.

RFC 7419 [51] specifies a set of common intervals which are used to ensure interoperability: 3.3ms, 10ms, 20ms, 50ms, 100ms and 1s.

**[R234]** If an LLO supports a value for the ENNI Link BFD Attribute other than *None*, they **MUST** support Transmission intervals of 100ms and 1s.

**[R235]** If an LLO supports a value for the ENNI Link BFD Attribute other than *None* and one of the common intervals specified in RFC 7419 [51] is supported, all of the longer common intervals specified in RFC 7419 [51] **MUST** be supported.

**[R236]** When the ENNI Link BFD Attribute is not *None*, the Detect Multiplier **MUST** be set to the specified value.

At least one end of the BFD session has to have an active role, meaning that it sends out asynchronous control messages regardless of whether it has received any. For simplicity, this specification mandates that both ends are active.

**[R237]** When the ENNI Link BFD Attribute is not *None*, both LLO devices **MUST** take an Active role.



If BFD is used, when the BFD session is down, the ENNI Link is usually considered non-operational. This has an impact on routes towards the ENNI Link, as described in section 9.1.

- [D20] When the ENNI Link BFD Attribute is not *None*, if the BFD Session is not in UP state (as described in RFC 5880 [44]), the ENNI Link **SHOULD** be considered non-operational for the purpose of determining whether routes towards the ENNI Link are active, as described in section 9.1.

The BFD Echo function can be supported, in the sense of being able to receive and loop back echo packets, by an LLO.

- [O29] An LLO **MAY** support the BFD Echo function.

BFD has several options for authentication.

- [R238] When the ENNI Link BFD Attribute is not *None*, and the Authentication Type is not *None*, the specified authentication type **MUST** be used as described in RFC 5880 [44].

Note: the additional parameters that need to be agreed for each authentication type are deferred to a future version of this specification.

## 16.6 ENNI Link IP MTU Attribute

The ENNI Link IP Maximum Transmit Unit (MTU) Attribute is an integer  $\geq 576$  that specifies the maximum length in octets of IP Packets that can be conveyed across the ENNI Link. It is used to determine the maximum value of the IPVC MTU (see section 10.10) for IPVCs attached to the ENNI containing the ENNI Link, and also affects IP Control Protocol Packets at the ENNI Link.

Note: at an ENNI using Option B or C, where IP Packets may be encapsulated with one or more MPLS labels, the value of this attribute refers to the length of the IP Packet alone, i.e. excluding the MPLS labels.

RFC 791 [1] specifies the minimum MTU for IPv4 Packets as 68 octets; however, it also requires that all devices can handle a packet of length 576 octets (possibly fragmented). This specification strengthens the requirements from RFC 791 [1], by defining the minimum MTU as 576 octets – that is, IPv4 Packets that are shorter than this are guaranteed not to be fragmented or discarded.

RFC 8200 [57] specifies the minimum MTU for IPv6 Packets as 1280 octets; therefore this value is recommended in all cases.

- [D21] The ENNI Link IP MTU **SHOULD** be greater than or equal to 1280 octets.

Note that if the ENNI Link is in an ENNI that has an IPVC with IPv6 enabled attached to it, the combination of [R42] and [R43] means that the ENNI Link IP MTU has to be greater than or equal to 1280.

Note also that the underlying Layer 2 technology that supports the ENNI Link (see section 16.2) needs to be able to convey IP Packets whose length is equal to the value of the ENNI Link IP MTU Attribute.

If an LLO transmits IP Control Protocol Packets across an ENNI Link, they cannot exceed the ENNI Link IP MTU. Similarly, Ingress IP Control Protocol Packets with a length greater than the ENNI Link IP MTU can be discarded by the receiving LLO, even if the corresponding protocol is normally peered. Note that the corresponding requirements for IP Data Packets can be found in section 10.10.

- [R239] Egress IP Control Protocol Packets **MUST** have a length less than or equal to the value of the ENNI Link IP MTU Attribute.
- [R240] Ingress IP Control Protocol Packets with a length less than or equal to the value of the ENNI Link IP MTU Attribute **MUST NOT** be discarded due to their length.
- [O30] Ingress IP Control Protocol Packets with a length strictly greater than the value of the ENNI Link IP MTU Attribute **MAY** be discarded.

## 17 Bandwidth Profiles

A Bandwidth Profile is a specification of the temporal properties of a sequence of IP Packets at an EI. The specification is in terms of a set of parameters. A real sequence of IP Packets can be checked against a Bandwidth Profile with a given set of parameters (a process called ‘metering’), and further action can be taken depending on the outcome of this check: for instance, discarding packets (policing) or delaying certain packets (shaping) in order to bring the sequence closer to conformance with the Bandwidth Profile specification. The metering, based on the Bandwidth Profile parameters, and the associated policing and/or shaping, can together provide commitments and limits on the amount of traffic that can flow over an EI, while ensuring the available bandwidth is divided fairly among multiple flows.

The specification of Bandwidth Profiles is based on Bandwidth Profile Flows and Bandwidth Profile Envelopes. A Bandwidth Profile Flow (BWP Flow) is a stream of IP Packets that meet certain criteria, and for which the amount of traffic is metered, policed and/or shaped. A Bandwidth Profile Envelope (BWP Envelope) is a set of one or more Bandwidth Profile Flows that are associated such that the amount of traffic for one flow can affect the amount that is permitted for another flow.

Bandwidth Profiles can be applied to Ingress IP Data Packets or Egress IP Data Packets. When applied to Ingress IP Data Packets, the Bandwidth Profile is applied to the traffic flowing across the UNI from the Subscriber towards the SP, or to traffic received across an ENNI. When a Bandwidth Profile is applied to Egress IP Data Packets, it is applied to traffic that is eligible to be transmitted across the UNI from the SP towards the Subscriber, or eligible to be transmitted across an ENNI.

Some examples showing possible locations for implementation of Bandwidth Profiles can be found in Appendix B.7.3.

The subsections below describe the structure of Bandwidth Profiles, and then describe BWP Flows and BWP Envelopes in more detail.

### 17.1 Structure of Bandwidth Profiles

At each UNI, Bandwidth Profile Envelopes can be specified in one of three ways. Ingress and Egress Bandwidth Profiles are specified separately, and can be specified in different ways. The three possibilities are:

- A single BWP Envelope for the UNI (sections 12.4 and 12.5).
- One BWP Envelope per UNI Access Link (sections 13.10 and 13.11). Note that if the UNI only contains a single UNI Access Link, then this option is the same as the first option.
- One BWP Envelope per IPVC EP (sections 11.11 and 11.12). Note that if the UNI only has a single IPVC EP, then this option is the same as the first option.

At an ENNI using Option A, Bandwidth Profile Envelopes can be specified in two ways:

- One BWP Envelope per ENNI Link (sections 14.4 and 14.5). Note that the same parameters are applied to every ENNI Link assigned the same ENNI Service Mapping Context.
- One BWP Envelope per IPVC EP (sections 11.11 and 11.12).

Note that the case where there are multiple IPVC EPs with a given ENNI Service Mapping Context at an ENNI is out of scope for this document. When there is only a single IPVC EP with a given ENNI Service Mapping Context, specifying a BWP Envelope per IPVC EP (the second option above) is equivalent to specifying a BWP Envelope for the ENNI Service Mapping Context. If there is only a single ENNI Link assigned to the ENNI Service Mapping Context, then the two options above are also equivalent.

Each BWP Envelope consists of a list of Bandwidth Profile Flows (and other parameters), and each Bandwidth Profile Flow specifies a stream of IP Packets. A given Bandwidth Profile Flow matches either Ingress IP Packets or Egress IP Packets.

An ingress Bandwidth Profile applies to Ingress IP Data Packets at an EI. An egress Bandwidth Profile applies to Egress-Eligible IP Packets at an EI. An Egress-Eligible Packet at a given EI is an IP Data Packet that meets all of the following criteria:

- The IP Data Packet is mapped to an IPVC on ingress, as described in section 11.5.1.
- The IP Data Packet should be delivered to the specified EI (i.e., should be transmitted over one of the UNI Access Links in the UNI or over one of the ENNI Links in the ENNI), per the packet delivery requirements of section 10.4.
- The IP Data Packet is not discarded per requirements [O2], [O7], [R47], [R51], [O8], [O9], [O10], [O11], [R73], [R77], [R87], [R123]; per requirement [R252] to comply with an ingress Bandwidth Profile; or to comply with the requirements of RFC 791 [1] or RFC 8200 [57].
- The IP Data Packet is not discarded as a result of another agreement between the SP and the Subscriber (for Subscriber IP Services), or between the SP/SO and an Operator (for Operator IP Services), for example as part of a value-added over-the-top service offering.

Note the similarity (and differences) of these criteria to the specification of Qualified Packets in section 10.9.2.

## 17.2 Bandwidth Profile Flows

A Bandwidth Profile Flow is a stream of IP Packets meeting certain criteria. The criteria that can be used depend on which BWP Envelope the BWP Flow is part of, as shown in Table 28.

**[R241]** Each Bandwidth Profile Flow **MUST** belong to exactly one BWP Envelope.

BWP Envelope	BWP Flow Criteria	BWP Flow Parameters
	All Ingress IP Data Packets at the UNI.	None

<b>BWP Envelope</b>	<b>BWP Flow Criteria</b>	<b>BWP Flow Parameters</b>
UNI Ingress BWP Envelope (section 12.4)	All Ingress IP Data Packets at the UNI that are mapped to any of a given set of IPVC EPs.	A set, each entry comprising: <ul style="list-style-type: none"> <li>• IPVC EP Identifier (section 11.1) for an IPVC EP located at the UNI.</li> </ul>
	All Ingress IP Data Packets at the UNI that are mapped to any of a given set of (IPVC EP, CoS Name) pairs.	A set, each entry comprising: <ul style="list-style-type: none"> <li>• IPVC EP Identifier (section 11.1) for an IPVC EP located at the UNI.</li> <li>• CoS Name from the IPVC List of Class of Service Names (section 10.8) for the IPVC that has the IPVC EP.</li> </ul>
	All Ingress IP Data Packets at the UNI that are received over one of a given set of UNI Access Links.	A set, each entry comprising: <ul style="list-style-type: none"> <li>• UNI Access Link Identifier (section 13.1) for a UNI Access Link in the UNI.</li> </ul>
	All Ingress IP Data Packets at the UNI that are received over one of a given set of UNI Access Links, and that are mapped to any of a given set of IPVC EPs.	A set, each entry comprising: <ul style="list-style-type: none"> <li>• UNI Access Link Identifier (section 13.1) for a UNI Access Link in the UNI.</li> </ul> A set, each entry comprising: <ul style="list-style-type: none"> <li>• IPVC EP Identifier (section 11.1) for an IPVC EP located at the UNI.</li> </ul>
	All Ingress IP Data Packets at the UNI that are received over one of a given set of UNI Access Links, and that are mapped to the any of a given set of (IPVC EP, CoS Name) pairs.	A set, each entry comprising: <ul style="list-style-type: none"> <li>• UNI Access Link Identifier (section 13.1) for a UNI Access Link in the UNI.</li> </ul> A set, each entry comprising: <ul style="list-style-type: none"> <li>• IPVC EP Identifier (section 11.1) for an IPVC EP located at the UNI.</li> <li>• CoS Name from the IPVC List of Class of Service Names (section 10.8) for the IPVC that has the IPVC EP.</li> </ul>
	All Egress-Eligible IP Packets at the UNI.	None

<b>BWP Envelope</b>	<b>BWP Flow Criteria</b>	<b>BWP Flow Parameters</b>
UNI Egress BWP Envelope (section 12.5)	All Egress-Eligible IP Packets at the UNI that are mapped to any of a given set of IPVC EPs.	A set, each entry comprising: <ul style="list-style-type: none"> <li>IPVC EP Identifier (section 11.1) for an IPVC EP located at the UNI.</li> </ul>
	All Egress-Eligible IP Packets at the UNI that, for any of a given set of (IPVC EP, CoS Name) pairs, are mapped to the IPVC EP and were mapped on ingress to the CoS Name.	A set, each entry comprising: <ul style="list-style-type: none"> <li>IPVC EP Identifier (section 11.1) for an IPVC EP located at the UNI.</li> <li>CoS Name from the IPVC List of Class of Service Names (section 10.8) for the IPVC that has the IPVC EP.</li> </ul>
	All Egress-Eligible IP Packets at the UNI that if transmitted, would be transmitted over one of a given set of UNI Access Links.	A set, each entry comprising: <ul style="list-style-type: none"> <li>UNI Access Link Identifier (section 13.1) for a UNI Access Link in the UNI.</li> </ul>
	All Egress-Eligible IP Packets at the UNI that if transmitted, would be transmitted over one of a given set of UNI Access Links, and that are mapped to any of a given set of IPVC EPs.	A set, each entry comprising: <ul style="list-style-type: none"> <li>UNI Access Link Identifier (section 13.1) for a UNI Access Link in the UNI.</li> </ul> A set, each entry comprising: <ul style="list-style-type: none"> <li>IPVC EP Identifier (section 11.1) for an IPVC EP located at the UNI.</li> </ul>
	All Egress-Eligible IP Packets at the UNI that if transmitted, would be transmitted over one of a given set of UNI Access Links, and that for any of a given set of (IPVC EP, CoS Name) pairs, are mapped to the IPVC EP and were mapped on ingress to the CoS Name.	A set, each entry comprising: <ul style="list-style-type: none"> <li>UNI Access Link Identifier (section 13.1) for a UNI Access Link in the UNI.</li> </ul> A set, each entry comprising: <ul style="list-style-type: none"> <li>IPVC EP Identifier (section 11.1) for an IPVC EP located at the UNI.</li> <li>CoS Name from the IPVC List of Class of Service Names (section 10.8) for the IPVC that has the IPVC EP.</li> </ul>
UNI Access Link Ingress	All Ingress IP Data Packets at the UNI that are received over the UNI Access Link.	None

<b>BWP Envelope</b>	<b>BWP Flow Criteria</b>	<b>BWP Flow Parameters</b>
BWP Envelope (section 13.10)	All Ingress IP Data Packets at the UNI that are received over the UNI Access Link, and are mapped to any of a given set of IPVC EPs.	A set, each entry comprising: <ul style="list-style-type: none"> <li>• IPVC EP Identifier (section 11.1) for an IPVC EP located at the UNI.</li> </ul>
	All Ingress IP Data Packets at the UNI that are received over the UNI Access Link, and are mapped to any of a given set of (IPVC EP, CoS Name) pairs.	A set, each entry comprising: <ul style="list-style-type: none"> <li>• IPVC EP Identifier (section 11.1) for an IPVC EP located at the UNI.</li> <li>• CoS Name from the IPVC List of Class of Service Names (section 10.8) for the IPVC that has the IPVC EP.</li> </ul>
UNI Access Link Egress BWP Envelope (section 13.11)	All Egress-Eligible IP Packets at the UNI that if transmitted, would be transmitted over the UNI Access Link.	None
	All Egress-Eligible IP Packets at the UNI that if transmitted, would be transmitted over the UNI Access Link, and are mapped to any of a given set of IPVC EPs.	A set, each entry comprising: <ul style="list-style-type: none"> <li>• IPVC EP Identifier (section 11.1) for an IPVC EP located at the UNI.</li> </ul>
	All Egress-Eligible IP Packets at the UNI that if transmitted, would be transmitted over the UNI Access Link, and that, for any of a given set of (IPVC EP, CoS Name) pairs, are mapped to the IPVC EP and were mapped on ingress to the CoS Name.	A set, each entry comprising: <ul style="list-style-type: none"> <li>• IPVC EP Identifier (section 11.1) for an IPVC EP located at the UNI.</li> <li>• CoS Name from the IPVC List of Class of Service Names (section 10.8) for the IPVC that has the IPVC EP.</li> </ul>
ENNI Ingress Bandwidth Profile Envelope	All Ingress IP Data Packets at the ENNI that are received over the ENNI Link.	None

<b>BWP Envelope</b>	<b>BWP Flow Criteria</b>	<b>BWP Flow Parameters</b>
(section 14.4, Envelope per ENNI Link)	All Ingress IP Data Packets at the ENNI that are received over the ENNI Link, and that are mapped to any of a given set of CoS Names.	<p>A set, each entry comprising:</p> <ul style="list-style-type: none"> <li>• CoS Name from the IPVC List of Class of Service Names (section 10.8) for the IPVC that has the IPVC EP with the same ENNI Service Mapping Context as the ENNI Link.</li> </ul> <p>Note the case that there is more than one IPVC EP with the same ENNI Service Mapping Context as the ENNI Link is out of scope.</p>
ENNI Egress Bandwidth Profile Envelope (section 14.5, Envelope per ENNI Link)	All Egress-Eligible IP Data Packets at the ENNI that if transmitted, would be transmitted over the ENNI Link.	None
	All Egress-Eligible IP Data Packets at the ENNI that if transmitted, would be transmitted over the ENNI Link, and that were mapped on ingress to any of a given set of CoS Names.	<p>A set, each entry comprising:</p> <ul style="list-style-type: none"> <li>• CoS Name from the IPVC List of Class of Service Names (section 10.8) for the IPVC that has the IPVC EP with the same ENNI Service Mapping Context as the ENNI Link.</li> </ul> <p>Note the case that there is more than one IPVC EP with the same ENNI Service Mapping Context as the ENNI Link is out of scope.</p>
IPVC EP Ingress BWP Envelope (section 11.11)	All Ingress IP Data Packets at the EI that are mapped to the IPVC EP.	None.
	All Ingress IP Data Packets at the EI that are mapped to the IPVC EP and to any of a given set of CoS Names.	<p>A set, each entry comprising:</p> <ul style="list-style-type: none"> <li>• CoS Name from the IPVC List of Class of Service Names (section 10.8) for the IPVC that has the IPVC EP.</li> </ul>
IPVC EP Egress BWP Envelope (section 11.12)	All Egress-Eligible IP Packets at the EI that are mapped to the IPVC EPs.	None.
	All Egress-Eligible IP Packets at the EI that are mapped to the IPVC EP and were mapped on ingress to any of a given set of CoS Names.	<p>A set, each entry comprising:</p> <ul style="list-style-type: none"> <li>• CoS Name from the IPVC List of Class of Service Names (section 10.8) for the IPVC that has the IPVC EP.</li> </ul>

**Table 28 – BWP Flow Criteria and Parameters**



- [R242] A Bandwidth Profile Flow used at a given EI **MUST** be specified using one of the criteria shown in Table 28, depending on the BWP Envelope it belongs to.

Further details of how packets are mapped to a given IPVC EP can be found in section 11.5.1, and of how packets are mapped to a given CoS Name in section 11.9. Note that since CoS Names are specific to a given IPVC, it is not possible to explicitly specify a Bandwidth Profile Flow that matches all packets received or transmitted at a given EI that match a given CoS Name, regardless of the IPVC EP to which they are mapped. However, if all of the IPVC EPs at an EI use the same CoS Names, then for each CoS Name a Bandwidth Profile Flow can be specified that matches that CoS Name at every IPVC EP. An example of this is shown in Appendix B.7.2.

Each Bandwidth Profile Flow has a number of parameters that need to be specified in order to define it.

- [R243] When a Bandwidth Profile Flow is specified using one of the criteria from Table 28, the corresponding parameters listed in Table 28 **MUST** also be specified.
- [R244] The Bandwidth Profile Flows specified at a given EI **MUST** be such that each Ingress IP Packet is mapped to at most one Bandwidth Profile Flow.
- [R245] The Bandwidth Profile Flows specified at a given EI **MUST** be such that each Egress-Eligible IP Packet is mapped to at most one Bandwidth Profile Flow.

Requirements [R244] and [R245] prohibit Bandwidth Profile Flows that overlap. For example, if a Bandwidth Profile Flow is specified using a criterion of All Ingress IP Data Packets at a UNI, then no Bandwidth Profile Flows can be specified using other criteria that match ingress packets, as an ingress packet would then map to both of them.

Note that a given IP Packet does not necessarily map to any Bandwidth Profile Flows, e.g. if no egress Bandwidth Profile is specified, there is no need to define any Bandwidth Profile Flows for egress packets, and so an Egress IP Packet will not map to any Bandwidth Profile Flow.

### 17.3 Bandwidth Profile Envelopes

A BWP Envelope is a list of Bandwidth Profile Flows, plus additional parameters for the BWP Envelope as a whole.

- [R246] All Bandwidth Profile Flows in a given BWP Envelope **MUST** be specified using the same criterion from Table 28.

Since an IP Packet is mapped to at most one BWP Flow on ingress and at most one BWP Flow on egress, and each BWP Flow belongs to exactly one BWP Envelope, the packet is metered against a Bandwidth Profile at most once on ingress and once on egress. Another perspective is that at ingress and at egress, the set of all IP Packets that flow across the EI is partitioned first into BWP Envelopes, and then each BWP Envelope is partitioned into BWP Flows, with the proviso that there might be some IP Packets that are not mapped to any BWP Envelope or BWP Flow.

As described above, there are eight BWP Envelope Service Attributes, corresponding to all of the possible ways that BWP Envelopes can be specified, for ingress and egress. In each case, if the Service Attribute is not *None*, the following parameters are specified. For the ENNI Ingress Bandwidth Profile Envelopes Service Attribute (section 14.4) and the ENNI Egress Bandwidth Profile Envelopes Service Attribute (section 14.5), these parameters are specified for each entry in the list.

- The Envelope Maximum Information Rate (denoted  $MaxIR_E$ ), in bits per second. This is the limit on the total aggregate information rate of traffic across all BWP Flows in the Envelope.
- The Envelope IR Time (denoted  $T_E$ ), in milliseconds. This is the time period over which average Information Rates are calculated, and thus it limits the size of a burst.
- The list of Bandwidth Profile Flows contained in the BWP Envelope, along with the parameters for each BWP Flow as specified below.

A number of additional parameters are specified for each Bandwidth Profile Flow as shown in Table 29.

Parameter Name	Sym- bol	Units/Values	Informal Description
Flow Definition		As described in Table 28.	Parameters that identify which IP Packets belong to the BWP Flow.
Flow Identifier	$i$	Unique integer between 1 and $n$ , where $n$ is the number of BWP Flows in the BWP Envelope.	Identifier for the BWP Flow within the BWP Envelope.
Committed Information Rate	$CIR$	Bits per second.	Average information rate of IP Packets that is committed to for this BWP Flow.
Maximum Information Rate	$MaxIR$	Bits per second.	Limit on the average information rate of IP Packets for this BWP Flow.
Weight	$W$	Integer greater than or equal to 0.	Relative weight for this BWP Flow compared to other BWP Flows in the BWP Envelope.
Burst Behavior	$B$	Either <i>Optimize-Delay</i> or <i>Optimize-Throughput</i> .	Whether the SP is requested to optimize the delay characteristics of this flow, or the throughput.

**Table 29 – Bandwidth Profile Parameters for a Bandwidth Profile Flow**

In a given BWP Envelope, the CIR, MaxIR, Weight and Burst Behavior for the Bandwidth Profile Flow with Flow Identifier  $i$  are denoted  $CIR_i$ ,  $MaxIR_i$ ,  $W_i$  and  $B_i$  respectively. Note that the Flow Identifier of a BWP Flow is used only as an identifier and does not imply any particular ordering or prioritization between the flows.

**[R247]** For a BWP Flow  $i$  contained in a BWP Envelope,  $MaxIR_i$  **MUST** be greater than or equal to  $CIR_i$ .

The total committed information rate for all the BWP Flows in a BWP Envelope cannot exceed the information rate for the BWP Envelope.

**[R248]** The sum of the  $CIR$  values for all BWP Flows in a BWP Envelope **MUST** be less than or equal to the  $MaxIR_E$  for the BWP Envelope.

That is, the following inequality holds:

$$\sum_{i=1}^n CIR_i \leq MaxIR_E$$

## 17.4 Bandwidth Profile Behavior

The effect of metering a stream of IP Packets against a Bandwidth Profile – that is, comparing the actual sequence of IP Packets to the description in terms of the Bandwidth Profile parameters – is to declare each packet either conformant or non-conformant. This information can be used to take further action, for example policing or shaping. The combined effect is such that each packet has one of three outcomes:

- The packet is discarded.
- The packet is passed immediately.
- The packet is passed after a short delay.

*The combined effect of metering a stream of IP Packets against a Bandwidth Profile with a given set of parameters, and then taking any consequent action, is typically implemented using policers (e.g. a token bucket policer as described in RFC 2698 [17] or MEF 41 [67]) or shapers; however, this specification does not constrain the implementation, and the SP or Operator can implement the behavior using policers, shapers, other mechanisms, or a mixture of these.*

The desired behavior described by a Bandwidth Profile is specified in terms of average information rates. The average information rate of a stream of IP Packets over a given time is defined to be the sum of the lengths of the IP Packets in the stream (in octets), multiplied by 8, and divided by the time in seconds. In other words, if  $N$  is the number of IP Packets in a stream of IP Packets that passes a reference point (e.g. a UNI) during a time interval of duration  $t$ , and  $L_p$  is the length of the  $p^{\text{th}}$  such IP Packet, the average information rate is:

$$IR = 8 \frac{\sum_{p=1}^N L_p}{t}$$

Recall that an IP Packet is defined to be from the start of the IP Version field to the end of the IP data field, inclusive, and the length is therefore calculated accordingly.

Defining the average information rate in this way means that bursts of IP Packets are possible; for instance, a burst of IP Packets might pass the reference point at a rate much higher than the average

information rate, but for a time much shorter than  $t$ , provided that IP packets pass the reference point at a rate lower than the average information rate for the remainder of  $t$ . The maximum size of such a burst is constrained by the time interval  $t$ .

Informally, the behavior of a Bandwidth Profile meter is as follows:

- For each BWP Flow  $i$  in a BWP Envelope, allocate up to  $CIR_i$  to that flow, if necessary (i.e. if at least that much traffic for the BWP Flow is arriving at the reference point).
- Determine how much available bandwidth remains, by subtracting the amounts allocated in step one from the  $MaxIR_E$  for the Envelope.
- Allocate this remainder across all the BWP Flows, such that:
  - No more is allocated to a given BWP Flow than the amount of traffic arriving for that flow at the reference point.
  - No more is allocated to a given BWP Flow than the  $MaxIR$  for that flow.
  - Taking into account the amount allocated in the first step above, the ratio of bandwidth allocated to contended flows is equal to the ratio of their Weights.

This behavior ensures that traffic is divided fairly between the BWP Flows according to their relative weights.

The behavior is captured in the following requirements.

- [R249] The average information rate for IP Packets in BWP Flow  $i$  over any time interval of duration  $T_E$  that are declared conformant by the Bandwidth Profile meter **MUST** be at least the lower of the average information rate for IP Packets in BWP Flow  $i$  over that time interval that are received by the Bandwidth Profile meter, and  $CIR_i$ .
- [O31] IP Packets in BWP Flow  $i$  **MAY** be declared non-conformant in order to ensure that the average information rate for such packets over any time interval of duration  $T_E$  that are declared conformant by the Bandwidth Profile meter is at most  $MaxIR_i$ .
- [O32] IP Packets in BWP Flows contained in a given BWP Envelope **MAY** be declared non-conformant in order to ensure that the average information rate for all such packets over any time interval of duration  $T_E$  that are declared conformant by the Bandwidth Profile meter is at most  $MaxIR_E$ .
- [R250] If IP Packets in BWP Flows contained in a given BWP Envelope are declared non-conformant per [O32], this **MUST** be done in such a way that [R249] is met for each such BWP Flow, and the ratio of the average information rates over any time interval of duration  $T_E$  for packets that are declared conformant across all BWP Flows in the Envelope is equal to the ratio of the weights for those BWP Flows, except when the average information rate for IP Packets in a BWP Flow over that time interval that are received by the Bandwidth Profile meter is less than the ratio of weights would otherwise indicate.

Note that the above requirements specify constraints over any time interval of duration  $T_E$  – i.e., they suggest a ‘sliding window’. Constraining bandwidth using a fixed, recurring, window can have the effect of allowing double the amount of traffic as intended, as described in MEF 23.2 [65] Appendix H.2.

**[R251]** An IP Packet in a BWP Flow **MUST** be declared conformant unless it meets one of the conditions in requirements [O31], [O32] or [R250].

**[R252]** IP Packets that are declared non-conformant by a Bandwidth Profile meter **MUST** be discarded.

Note that IP Packets discarded as a result of the above requirements are not considered Qualified IP Packets, and hence do not contribute to any Packet Loss Ratio objective that might be specified in the SLS. Conversely, IP Packets that are declared conformant by the Bandwidth Profile meter do constitute Qualified IP Packets (provided they meet the other criteria specified in section 10.9.2), and hence cannot be discarded without risk of failing to meet a Packet Loss Ratio objective in the SLS.

**[D22]** When IP Packets are discarded as a result of applying a Bandwidth Profile, the SP **SHOULD** use techniques such as Weighted Random Early Detect (WRED) to determine which IP Packets to discard.

As an illustration of the above behavior, consider a Bandwidth Profile with  $MaxIR_E = 100Mb/s$ , and the following BWP Flows:

Rank	CIR	MaxIR	Weight
1	20Mb/s	20Mb/s	0
2	0	40Mb/s	1
3	0	100Mb/s	5
4	0	100Mb/s	2

**Table 30 – Example of BWP Flow Parameters**

Now, for various traffic patterns, the following behavior is observed per the above requirements:

- Traffic offered for flow 1 at 200Mb/s, no traffic for other flows: traffic passed for flow 1 at 20Mb/s.
- Traffic offered for flow 2 at 200Mb/s, no traffic for other flows: traffic passed for flow 2 at 40Mb/s.
- Traffic offered for flow 3 at 200Mb/s, no traffic for other flows: traffic passed for flow 3 at 100Mb/s.
- Traffic offered for all flows at 200Mb/s each: traffic passed for flow 1 at 20Mb/s; for flow 2 at 10Mb/s, for flow 3 at 50Mb/s and for flow 4 at 20Mb/s. In this case, the amount of traffic passed in flows 2, 3 and 4 is in ratio 1:5:2, matching the ratio of their weights.
- Traffic offered for flow 1 at 8Mb/s, flow 2 at 8Mb/s, flow 3 at 200Mb/s and flow 4 at 200Mb/s: traffic passed at 8Mb/s for flow 1, 8Mb/s for flow 2, 60Mb/s for flow 3 and

24Mb/s for flow 4. In this case, the traffic offered in flow 2 is less than the ratio of weights would otherwise allocate to it, so all of it is passed. The amount of traffic passed in flows 3 and 4, which are contended, is in the ratio 5:2, matching the ratio of their weights.

Note that in this example, the BWP Flow with rank 1 has a weight of 0. This is because it has CIR greater than 0 and hence is always guaranteed some amount of bandwidth. In addition, the MaxIR is equal to its CIR, so it cannot get any additional bandwidth once the CIR bandwidth has been apportioned. Therefore, the weight value has no effect.

#### 17.4.1 Packet Bursts

When a burst of packets is received – that is, a number of IP Packets in quick succession such that the IR over a short time exceeds the average IR over  $T_E$  – it can be beneficial to delay some of the packets such that the burst is “smoothed out”. This is typically implemented by queuing packets (up to some maximum), and servicing the queue at the desired rate – in other words, by shaping.

The benefits of this “smoothing” behavior are twofold: firstly, it means that the aggregate of all traffic flows across the SPs network is more predictable, and hence the network can be implemented with smaller buffers; and secondly, the overall throughput for a given flow can be improved. The latter comes about because of the particular interaction between the behavior of TCP and round trip time – see, for example, Appendix G of MEF 23.2 [65], for analysis of this.

The disadvantage of “smoothing” bursty traffic is that packet delay and inter-packet delay variation are adversely affected. If packets are queued for transmission, then the average end-to-end delay will of course increase. Additionally, as different packets can be queued for different lengths of time, the delay variation is also increased.

To accommodate this, the final parameter for each BWP Flow in a BWP Envelope is the Burst Behavior. If the BWP Flow comprises traffic that is sensitive to delay and delay variation, such as voice or video traffic, then the Burst Behavior can be set to *Optimize-Delay*. Conversely, if for example, the BWP Flow comprises predominantly TCP traffic or is more sensitive to loss, the Burst Behavior can be set to *Optimize-Throughput*.

There are no specific requirements specifically relating to the Burst Behavior parameter; it is included as a guide for the SP or Operator as to how to implement the Bandwidth Profile behavior so as to meet the Subscriber’s or SP/SO’s needs and provide them with a good quality of experience; for example, whether to apply shaping, policing or a combination of these to the BWP Flow.

- [O33]** The SP or Operator **MAY** delay certain IP Packets in a given BWP Flow before applying the Bandwidth profile meter, in order to increase the number of IP Packets in the BWP Flow that are declared conformant.

Note that such a delay is included in the One-way Packet Delay (section 10.9.3), if it is specified between SLS-RPs that are IPVC EPs. The formal agreement on permissible delay, delay variation, and loss is agreed through the IPVC SLS Service Attribute (section 10.9).

Whether packets are delayed or not, they cannot be re-ordered.

**[R253]** The application of a Bandwidth Profile **MUST NOT** change the order of IP Packets within a given BWP Flow.

#### 17.4.2 Ingress Bandwidth Profiles

For a Subscriber IP Service, an ingress Bandwidth Profile is used as a mechanism for the Subscriber and the SP to agree on how the SP will regulate the amount of ingress traffic for each ingress Bandwidth Profile Flow at a UNI. For an Operator IP Service, it is a mechanism for the SP/SO and the Operator to agree on how the Operator will regulate the amount of ingress traffic for each ingress Bandwidth Profile Flow at an EI. In both cases, it is applied to the sequence of Ingress IP Data Packets received at an EI, possibly over a given UNI Access Link (in the case of the UNI Access Link Ingress Bandwidth Profile Envelope, section 13.10) or ENNI Link (in the case of an ENNI Ingress Bandwidth Profile Envelope, section 14.4), or mapped to a given IPVC EP (in the case of the IPVC EP Ingress Bandwidth Profile Envelope, section 11.11). It can be applied after any shaping that is performed by the SP or Operator rather than directly to the sequence of packets received, per requirement [O33].

*Note that there are no constraints on how an SP or Operator implements ingress Bandwidth Profile behavior; they might choose to discard sufficient packets as close to the ingress EI as possible, or they might choose only to mark packets at the ingress EI with a different drop-eligibility, and only discard them further into the network if there is congestion. This marking can be achieved, for example, by inserting a different DSCP into the packet.*

#### 17.4.3 Egress Bandwidth Profiles

For a Subscriber IP Service, an egress Bandwidth Profile is used as a mechanism for the Subscriber and the SP to agree on how the SP will regulate the amount of egress traffic for each egress Bandwidth Profile Flow at a UNI. For an Operator IP Service, it is used as a mechanism for the SP/SO and the Operator to agree on how the Operator will regulate the amount of egress traffic for each egress Bandwidth Profile Flow at an EI. As with all Service Attributes, the values that are agreed might affect the cost of the service or other aspects of the business relationship between the SP and the Subscriber or between the SP/SO and the Operator – such details are outside the scope of this document. However, in a multipoint IP Service with 3 or more EIs, or in a cloud access service, an egress Bandwidth Profile can also be specified to help handle a “focused overload” condition – that is, a condition where traffic received at multiple ingress EIs (or from a cloud service) is delivered to the same egress EI, per the packet delivery requirements of section 10.4. This might exceed the capacity of the egress EI. An egress Bandwidth Profile allows the SP and the Subscriber, or the SP/SO and the Operator, to agree on how much of such traffic can be discarded, while still complying with the IPVC SLS (see section 10.9).

An egress Bandwidth Profile is applied to the sequence of Egress-Eligible IP Packets at an EI, possibly for a given UNI Access Link (in the case of the UNI Access Link Egress Bandwidth Profile Envelope, section 13.11) or ENNI Link (in the case of an ENNI Egress Bandwidth Profile Envelope, section 14.5), or a given IPVC EP (in the case of the IPVC EP Egress Bandwidth Profile Envelope, section 11.12). It can be applied after any shaping that is performed by the SP or Operator rather than directly to the sequence of Egress-Eligible packets, per requirement [O33]. *As in the case of ingress Bandwidth Profiles, there are no constraints on how an SP or Operator implements an egress Bandwidth Profile; they might choose to delay or discard packets close to*

*the egress EI, or they might choose to delay or discard packets within the network, if it can be determined that they would otherwise be delayed or discarded at the egress EI.*

Note that for a Subscriber IP Service, when the egress UNI is oversubscribed – that is, when the Subscriber is sending more traffic into the SP Network that is delivered to a given UNI than the egress Bandwidth Profile at that UNI allows – the Subscriber cannot distinguish between IP Packets discarded due to the egress Bandwidth Profile and IP Packets that were lost within the SP Network for some other reason. In this case the Subscriber cannot independently measure the Packet Loss Ratio (see section 10.9.8), since packets discarded due to the egress Bandwidth Profile are not considered Qualified Packets (see section 10.9.2). Consequently, they cannot determine whether any PLR objective in the SLS (section 10.9) has been met. Under such circumstances, the Subscriber can only rely on the SP's measurements of PLR or on other information supplied by the SP, such as the number of packets discarded due to the egress Bandwidth Profile.

A Subscriber can detect that an oversubscription may be occurring if the average information rate of traffic received over the egress UNI for BWP Flows in a given BWP Envelope, over a time period of duration  $T_E$ , reaches or exceeds  $MaxIR_E$  for the envelope, or if the average information rate of traffic received for a given BWP Flow over a time period of duration  $T_E$  reaches or exceeds  $MaxIR$  for the BWP Flow. If neither of these are occurring – that is, if the total information rate of traffic for all flows in the BWP Envelope is less than  $MaxIR_E$ , and the information rate for each BWP Flow is less than  $MaxIR$  for the BWP Flow, then the egress Bandwidth Profile meter must have declared all IP Packets conformant, and hence the Subscriber can be sure that any packet loss is not due to the egress Bandwidth Profile and so can measure the PLR.

Avoiding focused overload scenarios may require over-dimensioning or complex functionality in the SP Network (e.g., CAC (call admission control), dynamic correlated shaping, etc.) and/or detailed knowledge of traffic matrix inside the IPVC. Both options suffer from disadvantages and may not be accepted by the Subscriber and/or Service Provider. An Egress BWP can be used to limit the impact of a focused overload scenario to only the Subscriber's less important/critical traffic.

In such scenarios, it can be ensured that focused overload is allowed to happen only to a given traffic class (e.g., best-effort), but other classes are not overloaded, e.g., Voice over IP (VoIP). For example, the CAC function of the VoIP controller(s) can ensure that VoIP traffic is not overloaded. Using separate BWP Flows for VoIP and best-effort packets and properly defining BWP Flow parameters in the egress BWP can protect VoIP traffic from the impact of the overload in the best-effort.



## 18 References

- [1] IETF RFC 791, *Internet Protocol*, September 1981
- [2] IETF RFC 792, *Internet Control Message Protocol*, September 1981
- [3] IETF RFC 1034, *Domain Names – Concepts and Facilities*, November 1987
- [4] IETF RFC 1191, *Path MTU Discovery*, November 1990
- [5] IETF RFC 1661, *The Point-to-Point Protocol (PPP)*, July 1994
- [6] IETF RFC 1997, *BGP Communities Attribute*, August 1996
- [7] IETF RFC 2119, *Key words for use in RFCs to Indicate Requirement Levels*, March 1997
- [8] IETF RFC 2131, *Dynamic Host Configuration Protocol*, March 1997
- [9] IETF RFC 2132, *DHCP Options and BOOTP Vendor Extensions*, March 1997
- [10] IETF RFC 2328, *OSPF Version 2*, April 1998
- [11] IETF RFC 2330, *Framework for IP Performance Metrics*, May 1998
- [12] IETF RFC 2439, *BGP Route Flap Damping*, November 1998
- [13] IETF RFC 2453, *RIP Version 2*, November 1998
- [14] IETF RFC 2474, *Definition of the Differentiated Services Field (DS Field) in the IPv4 and IPv6 Headers*, December 1998
- [15] IETF RFC 2475, *An Architecture for Differentiated Services*, December 1998
- [16] IETF RFC 2694, *DNS extensions to Network Address Translators (DNS\_ALG)*, September 1999
- [17] IETF RFC 2698, *A Two Rate Three Color Marker*, September 1999
- [18] IETF RFC 3022, *Traditional IP Network Address Translator (Traditional NAT)*, January 2001
- [19] IETF RFC 3046, *DHCP Relay Agent Information Option*, January 2001
- [20] IETF RFC 3101, *The OSPF Not-So-Stubby Area (NSSA) Option*, January 2003
- [21] IETF RFC 3168, *The Addition of Explicit Congestion Notification (ECN) to IP*, September 2001
- [22] IETF RFC 3260, *New Terminology and Clarifications for Diffserv*, April 2002

- [23] IETF RFC 3376, *Internet Group Management Protocol, Version 3*, October 2002
- [24] IETF RFC 3393, *IP Packet Delay Variation Metric for IP Performance Metrics (IPPM)*, November 2002
- [25] IETF RFC 3704, *Ingress Filtering for Multihomed Networks*, March 2004
- [26] IETF RFC 3810, *Multicast Listener Discovery Version 2 (MLDv2) for IPv6*, June 2004
- [27] IETF RFC 3849, *IPv6 Address Prefix Reserved for Documentation*, July 2004
- [28] IETF RFC 3973, *Protocol Independent Multicast – Dense Mode (PIM-DM): Protocol Specification (Revised)*, January 2005
- [29] IETF RFC 4271, *A Border Gateway Protocol 4 (BGP-4)*, January 2006
- [30] IETF RFC 4360, *BGP Extended Communities Attribute*, February 2006
- [31] IETF RFC 4364, *BGP/MPLS IP Virtual Private Networks (VPNs)*, February 2006
- [32] IETF RFC 4443, *Internet Control Message Protocol (ICMPv6) for the Internet Protocol Version 6 (IPv6) Specification*, March 2006
- [33] IETF RFC 4787, *Network Address Translation (NAT) Behavioral Requirements for Unicast UDP*, January 2007
- [34] IETF RFC 4821, *Packetization Layer Path MTU Discovery*, March 2007
- [35] IETF RFC 4862, *IPv6 Stateless Address Autoconfiguration*, September 2007
- [36] IETF RFC 5340, *OSPF for IPv6*, July 2008
- [37] IETF RFC 5382, *NAT Behavioral Requirements for TCP*, October 2008
- [38] IETF RFC 5398, *Autonomous System (AS) Number Reservation for Documentation Use*, December 2008
- [39] IETF RFC 5481, *Packet Delay Variation Applicability Statement*, March 2009
- [40] IETF RFC 5508, *NAT Behavioral Requirements for ICMP*, April 2009
- [41] IETF RFC 5597, *Network Address Translation (NAT) Behavioral Requirements for the Datagram Congestion Control Protocol*, September 2009
- [42] IETF RFC 5737, *IPv4 Address Blocks Reserved for Documentation*, January 2010
- [43] IETF RFC 5798, *Virtual Router Redundancy Protocol (VRRP) Version 3 for IPv4 and IPv6*, March 2010
- [44] IETF RFC 5880, *Bidirectional Forwarding Detection (BFD)*, June 2010

- [45] IETF RFC 5881, *Bidirectional Forwarding Detection (BFD) for IPv4 and IPv6 (Single Hop)*, June 2010
- [46] IETF RFC 6274, *Security Assessment of the Internet Protocol Version 4*, July 2011
- [47] IETF RFC 6793, *BGP Support for Four-Octet Autonomous System (AS) Number Space*, December 2012
- [48] IETF RFC 6888, *Common Requirements for Carrier-Grade NATs (CGNs)*, April 2013
- [49] IETF RFC 7021, *Assessing the Impact of Carrier-Grade NAT on Network Applications*, September 2013
- [50] IETF RFC 7130, *Bidirectional Forwarding Detection (BFD) on Link Aggregation Group (LAG) Interfaces*, February 2014
- [51] IETF RFC 7419, *Common Interval Support in Bidirectional Forwarding Detection*, December 2014
- [52] IETF RFC 7680, *A One-Way Loss Metric for IP Performance Metrics (IPPM)*, January 2016
- [53] IETF RFC 7761, *Protocol Independent Multicast – Sparse Mode (PIM-SM): Protocol Specification (Revised)*, March 2016
- [54] IETF RFC 7857, *Updates to Network Address Translation (NAT) Behavioral Requirements*, April 2016
- [55] IETF RFC 8106, *IPv6 Router Advertisement Options for DNS Configuration*, March 2017
- [56] IETF RFC 8174, *Ambiguity of Uppercase vs Lowercase in RFC 2119 Key Words*, May 2017
- [57] IETF RFC 8200, *Internet Protocol, Version 6 (IPv6) Specification*, July 2017
- [58] IETF RFC 8201, *Path MTU Discovery for IP version 6*, July 2017
- [59] IETF RFC 8299, *YANG Data Model for L3VPN service delivery*, October 2017
- [60] IETF RFC 8415, *Dynamic Host Configuration Protocol for IPv6 (DHCPv6)*, November 2018
- [61] IETF STD 5, *consists of RFC 791, RFC 792, RFC 919, RFC 922, RFC 950 and RFC 1112.*
- [62] IANA DSCP Registry,  
<http://www.iana.org/assignments/dscp-registry/dscp-registry.xhtml>

- [63] MEF 4, *Metro Ethernet Network Architecture Framework – Part 1: Generic Framework*, May 2004
- [64] MEF 10.4, *Subscriber Ethernet Service Attributes*, December 2018
- [65] MEF 23.2, *Carrier Ethernet Class of Service, Phase 3*, August 2016
- [66] MEF 26.2, *External Network Interfaces (ENNI) and Operator Service Attributes*, August 2016
- [67] MEF 41, *Generic Token Bucket Algorithm*, October 2013
- [68] MEF 47, *Carrier Ethernet Services for Cloud Implementation Agreement*, October 2014
- [69] MEF 51.1, *Operator Ethernet Service Definitions*, December 2018
- [70] International Organization for Standardization ISO/IEC 7498-1, *Information Technology – Open Systems Interconnection – Basic Reference Model: The Basic Model*, November 1994
- [71] ITU-T Recommendation Y.1540, *Internet protocol data communication service – IP packet transfer and availability performance parameters*, July 2016
- [72] ITU-T Recommendation Y.1541, *Network performance objectives for IP-based services*, December 2011

## Appendix A Using RFC 8299 for MEF IP Services (Informative)

IETF RFC 8299 [59] contains a Yang data model for L3VPN service delivery, that can be used for communication between Subscribers and SPs, or between SP/SOs and Operators, to deliver L3 VPN services. Consequently, many of the nodes specified in the Yang module are similar to Service Attributes specified in this document. This Appendix describes how the Yang module specified in RFC 8299 could be used to represent an IP Service specified per this document. In this Appendix, an IP Service specified using the Service Attributes defined in this document is referred to as a MEF IP Service.

One important difference between the definition of Service Attributes in this specification and the definition of the Yang module in RFC 8299 concerns how information is exchanged between the two parties. In common with other MEF specifications, the Service Attributes defined in this document are intended to cover all of the information that needs to be agreed between the Subscriber and the SP for a Subscriber IP Service, or between the SP/SO and the Operator for an Operator IP Service, but the method by which such agreement is reached is not specified (see section 7.2). In contrast, RFC 8299 divides the information that needs to be exchanged into two categories:

- Requests from the Subscriber to the SP (or from the SP/SO to the Operator); the SP (or Operator) can accept or reject the request.
- Information made available to the Subscriber by the SP (or to the SP/SO by the Operator).

The RFC 8299 Yang module only covers the first of these. Consequently, much of the information specified in the Service Attributes in this document is not included in the Yang module.

There are several other differences in scope between this specification and RFC 8299:

- Both this document and RFC 8299 only cover Option A at an ENNI for an Operator IP Service; however, RFC 8299 assumes the SP/SO is always one of the Operators, and hence does not distinguish between ENNI Service Attributes and ENNI Common Attributes.
- Multicast is included in RFC 8299 but is out of scope for this specification.
- Access Link Encryption is included in RFC 8299 but is out of scope for this specification.
- The RFC 8299 Yang module allows the user of a service (i.e. the Subscriber or SP/SO) to request particular constraints on how the service is implemented (by the SP or Operator), but for a MEF IP Service it is the performance objectives for the service that are agreed (via the SLS), and the SP or Operator is always free to implement the service however they choose provided they meet the performance objectives.
- Private Cloud Access is included in RFC 8299 but is deferred from this specification.
- This specification supports Rooted Multipoint services across an ENNI, by marking certain routes as being for leaves when *Trunk* role is used for the IPVC EPs. RFC 8299 does not support this.
- RFC 8299 includes Carrier's Carrier (as described in RFC 4364 [31]), but that is deferred from this specification.

The first subsection below describes differences in terminology between this document and RFC 8299; the second describes how a MEF IP Service can be represented using the RFC 8299 Yang module; and the subsequent subsections compare the Service Attributes for IPVCs, IPVC EPs, UNIs, UNI Access Links, ENNIs, and ENNI Links with the corresponding nodes in the Yang module. Each of these later subsections includes not only the Service Attributes and Yang nodes that are in common, but also those that are present in one document but not the other.

Note that aspects of a MEF IP Service that cannot be represented using the RFC 8299 Yang module might be able to be represented using an augmentation of that module.

### A.1 Terminology Alignment

Table 31 describes some of the terms used in this specification, and the closest equivalent term in RFC 8299.

MEF IP Services Term	Closest RFC 8299 Term
Customer Edge (CE)	Customer Edge (CE) – same definition.
Class of Service Name	Class ID
Egress IP Packet	No equivalent term; but “input bandwidth” is used to refer to traffic from the SP or Operator towards the Subscriber at a UNI (or from an Operator towards the peer Operator at an ENNI), in the context of specifying bandwidth.
External Network Network Interface (ENNI)	NNI, which for Option A is equated with “site”.
ENNI Link	Site Network Access (in the context of Option A).
Ingress IP Packet	No equivalent term; but “output bandwidth” is used to refer to traffic from the Subscriber towards the SP or Operator at a UNI (or from the peer Operator towards an Operator at an ENNI), in the context of specifying bandwidth.
IP Virtual Connection (IPVC)	VPN Service
IPVC End Point (IPVC EP)	No equivalent term.
Operator	Network Operator – this term covers any provider of an IP Service, i.e. RFC 8299 does not distinguish between providers of Subscriber Services and Operator Services.
Provider Edge (PE)	Provider Edge (PE) – same definition.
Provider-Managed CE	Provider-Managed CE – same definition.
Service Provider (SP)	Network Operator – this term covers any provider of an IP Service, i.e. RFC 8299 does not distinguish between providers of Subscriber Services and Operator Services.

MEF IP Services Term	Closest RFC 8299 Term
Subscriber	Customer – this term also covers SP/SOs in the context where they are the user of an Operator IP Service provided by another Operator, i.e. RFC 8299 does not distinguish between end users (Subscribers) and wholesale users.
Subscriber-Managed CE	Customer-Managed CE
User Network Interface (UNI)	Site – a “site” is similar to a UNI, but is a little more general in that links (“site network accesses”) within a single site can be attached to different VPNs.
UNI Access Link	Site Network Access
UNI Access Link L2 Technology	Bearer – this term is user to refer to the network below L3 that is used for a site network access.

**Table 31 – Terminology Comparison with RFC 8299**

## A.2 Representing MEF IP Services

Broadly speaking, the concepts represented in the Yang module in RFC 8299 are similar to those used in this specification. However, the Yang module in RFC 8299 does not have any construct that is equivalent to an IPVC End Point. Instead, VPN Services (IPVCs) are associated with Sites (UNIs or Option A ENNIs) via a number of other nodes.

Firstly, each site has a “VPN flavor”:

- Single – the site belongs to a single VPN.
- Multi – the site belongs to multiple VPNs, but all site network accesses belong to the same set of VPNs.
- Sub – the site belongs to multiple VPNs, and different site network access belong to different VPNs.
- NNI – the “site” represents an ENNI using Option A.

In addition, each site network access is associated with one or more VPNs via a “VPN attachment”. This can be specified in one of two ways:

- If the site network access is associated with a single VPN (i.e. in the “Single” or “Sub” flavors of site), then it can be referenced directly. The role that the site network access plays in the VPN can also be specified (any-to-any, hub or spoke).
- Alternatively, a “VPN Policy” is specified, which is a list where each entry contains a reference to a VPN, the role of the site network access within that VPN, and a list of IP Prefixes in the Subscriber Network that can access the VPN.

Given this, a MEF Subscriber IP Service can be represented in the Yang module as follows:

- The UNI is represented as a site.

- Each UNI Access Link is represented as a site network access.
- The site flavor is set to “Single” if there is only one IPVC EP at the UNI, or “Multi” if there is more than one. (The value “Sub” is not used to represent a MEF IP Service).
- A single VPN Policy is defined for the site, containing one entry for each IPVC EP at the UNI:
  - The VPN ID is for the VPN corresponding to the IPVC for the IPVC EP.
  - The role is:
    - any-to-any if the IPVC EP is for a Multipoint IPVC, or is for a Cloud Access IPVC where every IPVC EP has Root role.
    - hub if the IPVC EP is in a Rooted Multipoint IPVC and the IPVC EP has Root role, or the IPVC EP is in Cloud Access IPVC where this IPVC EP has Root role and there is at least one IPVC EP that has Leaf role.
    - spoke if the IPVC EP has Leaf Role (and it is in a Rooted Multipoint IPVC or a Cloud Access IPVC).
  - The list of prefixes corresponds with the IPVC EP Prefix Mapping Service Attribute.
- Each site network access references this VPN Policy in its VPN Attachment.

In a MEF Subscriber IP Service, the UNI Access Links in a given UNI are always all associated with the same set of IPVCs (there is no equivalent of a “Sub” flavored site). If it is desirable to associate different UNI Access Links with different IPVCs, then they can be assigned to different UNIs (i.e. different sites).

For a MEF Operator IP Service, the UNIs and UNI Access Links, and the IPVC EPs at UNIs, can be represented in the Yang module as described for MEF Subscriber IP Services above. ENNIs, ENNI Links and IPVC EPs at ENNIs can be represented as follows, bearing in mind that RFC 8299 assumes that the SP/SO is the LLO on one side of the ENNI, and that the service in question is being provided by the LLO on the other side of the ENNI.

- Each ENNI Service Mapping Context at an ENNI using Option A is represented as a site.
- Each ENNI Link assigned that ENNI Service Mapping Context is represented as a site network access.
- The site flavor is set to “NNI”.
- A single VPN Policy is defined for the site, containing a single entry for the IPVC EP with the ENNI Service Mapping Identifier corresponding to that ENNI Service Mapping Context:
  - The VPN ID is for the VPN corresponding to the IPVC for the IPVC EP.
  - The role is:
    - any-to-any if the IPVC EP is for a Multipoint IPVC.
    - hub if the IPVC EP is in a Rooted Multipoint IPVC and the IPVC EP has Root role.
    - spoke if the IPVC EP has Leaf Role (and it is in a Rooted Multipoint IPVC).
  - The list of prefixes is empty.
- Each site network access references this VPN Policy in its VPN Attachment.



Note that if the IPVC EP at the ENNI has Trunk Role, it cannot be represented in the Yang module.

### A.3 IPVC Service Attributes

Each IPVC for a MEF IP Service can be represented in the RFC 8299 Yang module as a VPN Service. Table 32 shows the IPVC Service Attributes defined in section 10, and how these can be represented in the Yang module. It also includes other nodes that are defined in the Yang module that do not correspond with MEF IP Service Attributes.

Service Attribute	RFC 8299 Yang Node (under /l3vpn-svc/vpn-services/vpn-service)	Notes
IPVC Identifier	vpn-id	Equivalent
IPVC Topology	vpn-service-topology	<i>Multipoint</i> is equivalent to any-to-any. <i>Rooted Multipoint</i> is equivalent to hub-spoke. <i>Cloud Access</i> can be represented as any-to-any (if it only contains IPVC EPs with <i>Root</i> role) or hub-spoke (if it contains any IPVC EPs with <i>Leaf</i> role). The value <i>hub-spoke-disjoint</i> is not used for MEF IP Services. The same effect can be achieved by instantiating two <i>Rooted Multipoint</i> IPVCs.
IPVC End Point List	No equivalent	See Section A.2. In RFC 8299, each IPVC EP specifies the IPVC (VPN) it is part of, rather than vice versa, using the VPN Policy.
IPVC Packet Delivery	No equivalent	RFC 8299 assumes <i>Standard Routing</i> ; a value of <i>Policy-Based Routing</i> cannot be represented in the Yang module.
IPVC Maximum Number of IPv4 Routes	No equivalent	Cannot be represented in the Yang module.
IPVC Maximum Number of IPv6 Routes	No equivalent	Cannot be represented in the Yang module.
IPVC DSCP Preservation	No equivalent	Cannot be represented in the Yang module.
IPVC List of Class of Service Names	No equivalent	Cannot be represented in the Yang module.
IPVC Service Level Specification	No equivalent	Cannot be represented in the Yang module.

Service Attribute	RFC 8299 Yang Node (under /l3vpn-svc/vpn-services/vpn-service)	Notes
IPVC MTU	No equivalent	Cannot be represented in the Yang module.
IPVC Path MTU Discovery	No equivalent	Cannot be represented in the Yang module.
IPVC Fragmentation	No equivalent	Cannot be represented in the Yang module.
Cloud Access:	cloud-accesses/cloud-access/...:	In the Yang module there is a list of clouds; for a MEF IP Service this list contains at most one entry (separate IPVCs can be instantiated for different cloud services, but each IPVC is only associated with a single cloud service).
• Cloud Type	No equivalent	Cannot be represented in the Yang module.
• Cloud Ingress CoS Map	No equivalent	Cannot be represented in the Yang module.
• Cloud Data Limit	No equivalent	Cannot be represented in the Yang module.
• Cloud NAT	.../address-translation/nat-44	The Yang module only allows a single IPv4 address to be specified. If the MEF IP Service uses a prefix with a prefix length less than 32, this cannot be represented in the Yang module.
• Cloud DNS Service	No equivalent	Cannot be represented in the Yang module.
• Cloud Subscriber Prefix List	No equivalent	Cannot be represented in the Yang module.
No equivalent	.../list-flavor	The Yang module has access control allowing different sites to access different cloud services. This is not needed as there is only a single cloud service per IPVC as defined in this specification. For MEF IP Services, list-flavor/permit-any/permit-any is always set.
IPVC Reserved Prefixes	No equivalent	Cannot be represented in the Yang module.

Service Attribute	RFC 8299 Yang Node (under /l3vpn-svc/vpn-services/vpn-service)	Notes
No equivalent	customer-name	In the Yang module, this field is intended to be used when a SP/SO uses a service provided by an Operator, to specify the name of the end user customer. In the MEF model, the Operator does not have a business relationship with the end user so this is not needed, and therefore this leaf is never set.
No equivalent	multicast	Not in scope for this specification – for MEF IP Services, the container is always empty.
No equivalent	carriers-carrier	Not in scope for this specification – for MEF IP Services, this leaf is always false.
No equivalent	extranet-vpns	In the Yang module, these nodes can be used to specify a number of other VPN services for which this one is an extranet. This is a shortcut for a common case of extranets. For MEF IP Services, an extranet is always represented as an additional IPVC, so this container is always empty.

**Table 32 – IPVC Service Attributes Comparison with RFC 8299**

#### A.4 IPVC End Point Service Attributes

Table 33 shows the IPVC End Point Service Attributes defined in section 11, and how these can be represented in the RFC 8299 Yang module.

Service Attribute	RFC 8299 Yang Node (under /l3vpn-svc/sites/site/vpn-policies/vpn-policy/entries)	Notes
IPVC EP Identifier	id	Equivalent.

Service Attribute	RFC 8299 Yang Node (under /13vpn-svc/sites/site/vpn-policies/vpn-policy/entries)	Notes
IPVC EP EI Type	Implicit	Corresponds with whether the site that the VPN policy is under in the data tree has “NNI” flavor or not.
IPVC EP EI	Implicit	Corresponds with the site that the VPN policy is under in the data tree.
IPVC EP Role	vpn/site-role	<p><i>Root</i> role in a Multipoint IPVC: any-to-any-role.</p> <p><i>Root</i> role in a Rooted Multipoint IPVC: hub-role.</p> <p><i>Root</i> role in a Cloud Access IPVC that only has IPVC EPs with <i>Root</i> role: any-to-any-role.</p> <p><i>Root</i> role in a Cloud Access IPVC that has at least one IPVC EPs with <i>Leaf</i> role: hub-role</p> <p><i>Leaf</i> role in a Cloud Access IPVC: spoke-role.</p> <p><i>Leaf</i> role in a Rooted Multipoint IPVC: spoke-role.</p> <p><i>Trunk</i> role in a Rooted Multipoint IPVC: cannot be represented in the Yang module.</p>
IPVC EP Prefix Mapping	filters/filter/ipv4-lan-prefix and filters/filter/ipv6-lan-prefix	<p>RFC 8299 has separate lists for IPv4 and IPv6 Prefixes, with filters/filter/type set accordingly.</p> <p>Note that the lan-tag type in RFC 8299 is not used for MEF IP Services.</p>
IPVC EP ENNI Service Mapping Identifier	Implicit	Each IPVC EP ENNI Service Mapping Identifier is represented as a separate site, thus this corresponds with the site that the VPN policy is under in the data tree. See section A.2.
IPVC EP Max IPv4 Routes	No equivalent	If the UNI only has a single IPVC EP, can be represented using /13vpn-svc/sites/site/maximum-routes/address-family/maximum-routes. Otherwise, cannot be represented in the Yang module.
IPVC EP Max IPv6 Routes	No equivalent	
IPVC EP Ingress CoS Map	No equivalent	See below.
IPVC EP Egress CoS Map	No equivalent	Cannot be represented in the Yang module.

Service Attribute	RFC 8299 Yang Node (under /l3vpn-svc/sites/site/vpn-policies/vpn-policy/entries)	Notes
IPVC EP Ingress BWP Envelope	No equivalent	Cannot be represented in the Yang module. However, the UNI Ingress BWP Envelope, UNI Access Link Ingress BWP Envelope and ENNI Ingress BWP Envelopes can be represented in certain cases, see section A.9.
IPVC EP Egress BWP Envelope	No equivalent	Cannot be represented in the Yang module. However, the UNI Egress BWP Envelope, UNI Access Link Egress BWP Envelope and ENNI Egress BWP Envelopes can be represented in certain cases, see section A.9.

**Table 33 – IPVC EP Service Attributes Comparison with RFC 8299**

#### A.4.1 Class of Service Classification

The IPVC EP Ingress Class of Service Map Service Attribute describes how to map Ingress IP Data Packets to a class of service name. In the RFC 8299 Yang module, the QoS Classification Policy performs a similar function; however, this is specified per site. The IPVC EP Ingress Class of Service Map Service Attribute can be represented using this per-site QoS Classification Policy as described below.

The QoS Classification Policy described in RFC 8299 consists of a list of rule entries. For a UNI that has only a single IPVC EP, or for a given ENNI Service Mapping Context at an ENNI (which only ever has a single IPVC EP), the per-site QoS classification policy can easily be used to represent the IPVC EP Ingress Class of Service Map for that IPVC EP. However, for a UNI that has multiple IPVC EPs, it is more difficult. In this case, additional filters need to be added to the rule entries in the QoS Classification policy to ensure they only match packets mapped to a particular IPVC. This can be done in a number of ways:

- If the set of IPVCs containing the IPVC EPs at the UNI do not have any remote EIs in common, then the target-sites list in the QoS Classification policy can be used to distinguish entries for the different IPVC EPs; that is, for each IPVC EP, the corresponding rule entries in the QoS Classification policy should each specify a list of target-sites containing all of the sites that correspond with other EIs that have IPVC EPs in the same IPVC as this IPVC EP.
- If two (or more) of the IPVCs containing the IPVC EPs at the UNI have at least one remote EI in common, it may be possible to use a combination of specifying the target sites, source IP prefixes and destination IP prefixes for each entry in the QoS Classification Policy to ensure it only matches IP Packets mapped to the corresponding IPVC EP. However, in this situation, the choice of IPVC EP may be dynamic, depending on the current routing information, so specifying a static list of prefixes may be undesirable. In

this case, the IPVC EP Ingress Class of Service Maps for the IPVC EPs at the UNI cannot be reliably represented in the Yang module.

The IPVC EP Ingress Class of Service Map Service Attribute can be represented using the QoS Classification policy (/l2vpn-svc/sites/site/service/qos/qos-classification-policy) as follows:

- Each entry in *M* in the IPVC EP Ingress Class of Service Map Service Attribute is represented by an entry in the rule list in the Yang module:
  - The id can be set to any arbitrary index value.
  - The match-type/match-flow option is always used; the match-type/match-application is not used.
  - Under match-flow, a set of yang leaves are specified, with values taken from the entry in *M*. Which leaves in the yang module are used is determined from *F* in the IPVC EP Ingress Class of Service Map Service Attribute, as shown in Table 34. In addition, the target-sites and the source and destination prefix leaves may be set to fixed values in every entry for this IPVC EP in the rule list, as described above.
  - The target-class-id is set equal to the CoS Name from the entry in *M*.
- An additional entry in the rule list is added to represent the value of *D* the IPVC EP Ingress Class of Service Map Service Attribute. This entry has an arbitrary id and has target-class-id set to the value of *D*. It does not have any match-type specified.

Field included in <i>F</i> in the IPVC EP Ingress CoS Map	Leaf included in the rule entry in the QoS Classification Policy (under match-flow/)
IP DS	dscp
Source IP Address	ipv4-src-prefix or ipv6-src-prefix
Destination IP Address	ipv4-dst-prefix or ipv6-dst-prefix
L4 Protocol	protocol-field (specified as a uint8)
Source L4 port	l4-src-port
Destination L4 port	l4-dst-port
Ethernet PCP	dot1p

**Table 34 – Comparison of Fields for Class of Service Map**

The l4-src-port-range and l4-dst-port-range nodes in the Yang module are not used to represent a MEF IP Service.

### A.5 UNI Service Attributes

Each UNI for a MEF IP Service can be represented in the RFC 8299 Yang module as a site. Table 35 shows the UNI Service Attributes defined in section 12, and how these can be represented in the Yang module. It also includes other nodes that are defined in the Yang module that do not correspond with MEF IP Service Attributes.

Service Attribute	RFC 8299 Yang Node (under /l3vpn-svc/sites/site)	Notes
UNI Identifier	site-id	Equivalent.

Service Attribute	RFC 8299 Yang Node (under /l3vpn-svc/sites/site)	Notes
UNI Management Type	management/type	<i>Subscriber-Managed</i> is equivalent to customer-managed. <i>Provider-Managed</i> is equivalent to provider-managed. The value co-managed is not used for MEF IP Services.
UNI List of UNI Access Links	site-network-accesses/site-network-access	Equivalent.
UNI Ingress Bandwidth Profile Envelope	See section A.9	See section A.9.
UNI Egress Bandwidth Profile Envelope	See section A.9	See section A.9.
UNI List of Control Protocols	No equivalent	Cannot be represented in the Yang module.
UNI Routing Protocols	routing-protocols/routing-protocol/...	
<ul style="list-style-type: none"> <li>Protocol</li> </ul>	.../type	<i>Static</i> , <i>BGP</i> and <i>OSPF</i> values are equivalent. Other values defined in RFC 8299 (rip, vrrp, direct) are not used for MEF IP Services.
<ul style="list-style-type: none"> <li>Address Family</li> </ul>	.../ospf/address-family or .../bgp/address-family	RFC 8299 uses a leaf-list containing one or both of IPv4 and IPv6 – a MEF IP Service with value <i>Both</i> is represented by including both IPv4 and IPv6 in the list. For static routing, the address families are represented in the yang simply by having separate lists for IPv4 and IPv6 prefixes.
<ul style="list-style-type: none"> <li>Static: list of: <ul style="list-style-type: none"> <li>Prefix</li> <li>Nexthop</li> <li>Admin Distance</li> </ul> </li> </ul>	.../static/cascaded-lan/prefixes/ipv4-lan-prefixes/... or .../static/cascaded-lan/prefixes/ipv6-lan-prefixes/... <ul style="list-style-type: none"> <li>.../lan</li> <li>.../next-hop</li> </ul>	RFC 8299 has separate lists for IPv4 and IPv6 routes. A nexthop that specifies a specific UNI Access Link cannot be represented in the yang module. The admin distance cannot be represented in the yang module.

Service Attribute	RFC 8299 Yang Node (under /l3vpn-svc/sites/site)	Notes
<ul style="list-style-type: none"> <li>• OSPF               <ul style="list-style-type: none"> <li>○ Area ID</li> <li>○ Area Type</li> <li>○ Authentication</li> <li>○ Hello Interval</li> <li>○ Dead Interval</li> <li>○ Retransmit Interval</li> <li>○ Admin Distance</li> </ul> </li> </ul>	.../ospf/... <ul style="list-style-type: none"> <li>• area-address</li> </ul>	Area ID is equivalent to area-address; other parameters of a MEF IP Service cannot be represented in the Yang module.
No equivalent	.../ospf/... <ul style="list-style-type: none"> <li>• metric</li> <li>• sham-links</li> </ul>	OSPF metric is not specified explicitly for MEF IP Services since that would constrain the SP's or Operator's implementation. It is always unset for MEF IP Services. Sham links are deferred to a future version of this specification.
<ul style="list-style-type: none"> <li>• BGP               <ul style="list-style-type: none"> <li>○ Subscriber's AS Number</li> <li>○ Peer's AS Number</li> <li>○ Connection Address Family</li> <li>○ Peering Addresses</li> <li>○ Authentication</li> <li>○ BGP Community List</li> <li>○ BGP Extended Community List</li> <li>○ Hold Time</li> <li>○ Damping</li> <li>○ AS Override</li> <li>○ Admin Distance</li> </ul> </li> </ul>	.../bgp/... <ul style="list-style-type: none"> <li>• autonomous-system</li> </ul>	Subscriber's AS Number is represented by bgp/autonomous-system; other parameters of a MEF IP Service cannot be represented in the Yang module.
UNI Reverse Path Forwarding	No equivalent	Cannot be represented in the Yang module.
No equivalent	requested-site-start	Out of scope for MEF IP Service Attributes as this pertains to the use of the service not the definition of the service; it would be handled at the Product layer. This is always unset for MEF IP Services.



<b>Service Attribute</b>	<b>RFC 8299 Yang Node (under /l3vpn-svc/sites/site)</b>	<b>Notes</b>
No equivalent	requested-site-stop	Out of scope for MEF IP Service Attributes as this pertains to the use of the service not the definition of the service; it would be handled at the Product layer. This is always unset for MEF IP Services.
No equivalent	locations	Out of scope for MEF IP Service Attributes as this pertains to the use of the service not the definition of the service; it would be handled at the Product layer. It is always an empty list for MEF IP Services.
No equivalent	devices	Out of scope for MEF IP Service Attributes as this pertains to the use of the service not the definition of the service; it would be handled at the Product layer. It is always an empty list for MEF IP Services.
No equivalent	site-diversity	Not used for MEF IP Services, as this relates to specification of constraints on the SP or Operator implementation (see introduction to Appendix A). It is always an empty list for MEF IP Services.
No equivalent	vpn-policies	See section A.2.
No equivalent	site-vpn-flavor	See section A.2.
No equivalent	maximum-routes	If there is only one VPN at the site, then this is equivalent to the IPVC EP Maximum IPv4/IPv6 routes. Otherwise, there is no equivalent as this specification has a per-IPVC EP limit rather than a per-UNI limit.
No equivalent	security	Not in scope for MEF IP Services. This is always empty for MEF IP Services.
No equivalent	service/qos/qos-classification-policy	See section A.4.1.
No equivalent	service/qos/qos-profile	See section A.9.
No equivalent	service/carrierscarrier/signalling-type	Not in scope for MEF IP Services. This is always unset for MEF IP Services.
No equivalent	service/multicast	Not in scope for MEF IP Services. This is always empty for MEF IP Services.
No equivalent	traffic-protection	This is a constraint on the SP or Operator implementation; for MEF IP Services, it is handled by specifying SLS objectives. Always unset for MEF IP Services.

Service Attribute	RFC 8299 Yang Node (under /3vpn-svc/sites/site)	Notes
No equivalent	actual-site-start (read-only)	Out of scope for MEF IP Service Attributes as this pertains to the use of the service not the definition of the service; it would be handled at the Product layer.
No equivalent	actual-site-stop (read-only)	Out of scope for MEF IP Service Attributes as this pertains to the use of the service not the definition of the service; it would be handled at the Product layer.

**Table 35 – UNI Service Attributes Comparison with RFC 8299**

### A.6 UNI Access Link Service Attributes

Each UNI Access Link for a MEF IP Service can be represented in the RFC 8299 Yang module as a Site Network Access. Table 36 shows the UNI Access Link Service Attributes defined in section 13, and how these can be represented in the Yang module. It also includes other nodes that are defined in the Yang module that do not correspond with MEF IP Service Attributes.

Service Attribute	RFC 8299 Yang Node (under /3vpn-svc/sites/site/site-network-accesses/site-network-access)	Notes
UNI Access Link Identifier	site-network-access-id	Equivalent.
UNI Access Link Connection Type	site-network-access-type	Equivalent.
UNI Access Link L2 Technology	bearer/	Although these are equivalent concepts, the parameters specified in the RFC 8299 Yang module are in the context of a request from the customer to the SP (or a SP/SO to an Operator), so may not be applicable to a MEF IP Service and are therefore not set. The Yang module notes that the bearer container is to be augmented with bearer-specific parameters; this is aligned with the UNI Access Link L2 Technology Service Attribute, for which the details are not specified in this document.

Service Attribute	RFC 8299 Yang Node (under /l3vpn-svc/sites/site/site-network-accesses/site-network-access)	Notes
UNI Access Link IPv4 Connection Addressing	ip-connection/ipv4/... .../address-allocation-type	<p><i>None</i> can be represented by not setting this leaf.</p> <p><i>DHCP</i> is equivalent to provider-dhcp.</p> <p><i>Static</i> is equivalent to static-address, or provider-dhcp-relay as described below.</p> <p>There is no equivalent in the RFC 8299 Yang module for <i>Unnumbered</i>. A MEF IP Service using <i>Unnumbered</i> cannot be represented, except where DHCP Relay is used as described below.</p> <p>The value provider-dhcp-relay is used to represent a MEF IP Service when the UNI Access Link DHCP Relay Service Attribute contains any IPv4 addresses – see below.</p>
<ul style="list-style-type: none"> <li>• DHCP               <ul style="list-style-type: none"> <li>○ Primary Subnet:                   <ul style="list-style-type: none"> <li>▪ IPv4 Prefix</li> <li>▪ SP/Operator IPv4 Addresses</li> <li>▪ Reserved Prefixes</li> </ul> </li> <li>○ Secondary Subnets:                   <ul style="list-style-type: none"> <li>▪ IPv4 prefix</li> <li>▪ SP/Operator IPv4 Addresses</li> <li>▪ Reserved Prefixes</li> </ul> </li> </ul> </li> </ul>	<p>.../provider-dhcp/...</p> <ul style="list-style-type: none"> <li>• provider-address</li> <li>• mask</li> <li>• address-assign/explicit/customer-addresses/address-group</li> </ul>	<p>The RFC 8299 Yang module provides equivalents for the Primary Subnet parameters, but Secondary Subnets cannot be represented in the Yang module. Similarly, the Yang module only provides for a single SP address. The option to specify address-assign/number/number-of-dynamic-address is not used for MEF IP Services.</p>

Service Attribute	RFC 8299 Yang Node (under /l3vpn-svc/sites/site/site-network-accesses/site-network-access)	Notes
<ul style="list-style-type: none"> <li>• Static               <ul style="list-style-type: none"> <li>○ Primary Subnet:                   <ul style="list-style-type: none"> <li>▪ IPv4 Prefix</li> <li>▪ SP/Operator IPv4 Addresses</li> <li>▪ Subscriber IPv4 Address</li> <li>▪ Reserved Prefixes</li> </ul> </li> <li>○ Secondary Subnets:                   <ul style="list-style-type: none"> <li>▪ IPv4 Prefix</li> <li>▪ SP/Operator IPv4 Addresses</li> <li>▪ Reserved Prefixes</li> </ul> </li> </ul> </li> </ul>	<p>.../addresses/...</p> <ul style="list-style-type: none"> <li>• provider-address</li> <li>• customer-address</li> <li>• mask</li> </ul>	<p>The RFC 8299 Yang module provides equivalents for the Primary Subnet IPv4 Prefix, the first Primary Subnet SP IPv4 Address, and the Subscriber IPv4 Address; any further SP IPv4 Addresses, the Primary Subnet Reserved Prefixes and any Secondary Subnets cannot be represented in the Yang module.</p>
<p>UNI Access Link IPv6 Connection Addressing</p>	<p>ip-connection/ipv6/... .../address-allocation-type</p>	<p><i>None</i> can be represented by not setting this leaf.  <i>DHCP</i> is equivalent to provider-dhcp.  <i>Static</i> is equivalent to static-address, or provider-dhcp-relay as described below.  <i>SLAAC</i> is equivalent to slaac.            There is no equivalent in the RFC 8299 Yang module for <i>LL-only</i>. A MEF IP Service using <i>LL-only</i> cannot be represented, except where DHCP Relay is used as described below.            The value provider-dhcp-relay is used to represent a MEF IP Service when the UNI Access Link DHCP Relay Service Attribute contains any IPv6 addresses – see below.</p>

Service Attribute	RFC 8299 Yang Node (under /l3vpn-svc/sites/site/site-network-accesses/site-network-access)	Notes
<ul style="list-style-type: none"> <li>• DHCP               <ul style="list-style-type: none"> <li>○ Subnet List:                   <ul style="list-style-type: none"> <li>▪ IPv6 Prefix</li> <li>▪ SP/Operator IPv6 Addresses</li> <li>▪ Reserved Prefixes</li> </ul> </li> </ul> </li> </ul>	<p>.../provider-dhcp/...</p> <ul style="list-style-type: none"> <li>• provider-address</li> <li>• mask</li> <li>• address-assign/explicit/customer-addresses/address-group</li> </ul>	<p>The RFC 8299 Yang module provides equivalents for the Subnet parameters, but only for a single subnet with a single SP address. Multiple subnets or multiple SP addresses cannot be represented in the Yang module. The option to specify address-assign/number/number-of-dynamic-address is not used for MEF IP Services.</p>
<ul style="list-style-type: none"> <li>• Static               <ul style="list-style-type: none"> <li>○ Subnet List:                   <ul style="list-style-type: none"> <li>▪ IPv6 Prefix</li> <li>▪ SP/Operator IPv6 Addresses</li> <li>▪ Reserved Prefixes</li> </ul> </li> <li>○ Subscriber IPv4 Address</li> </ul> </li> </ul>	<p>.../addresses/...</p> <ul style="list-style-type: none"> <li>• provider-address</li> <li>• customer-address</li> <li>• mask</li> </ul>	<p>The RFC 8299 Yang module provides equivalents for Subscriber IPv6 Address, and the first SP IPv6 Address and Subnet Mask length for a single subnet. The Subnet Reserved Prefixes, any further SP addresses and any further Subnets, cannot be represented in the Yang module.</p>
<ul style="list-style-type: none"> <li>• SLAAC               <ul style="list-style-type: none"> <li>○ Subnet List:                   <ul style="list-style-type: none"> <li>▪ IPv6 Prefix</li> <li>▪ SP/Operator IPv6 Addresses</li> <li>▪ Reserved Prefixes</li> </ul> </li> </ul> </li> </ul>	<p>No equivalent</p>	<p>SLAAC parameters cannot be represented in the Yang module.</p>

Service Attribute	RFC 8299 Yang Node (under /l3vpn-svc/sites/site/site-network-accesses/site-network-access)	Notes
UNI Access Link DHCP Relay	ip-connection/ipv4/dhcp-relay/customer-dhcp-servers/server-ip-address and ip-connection/ipv6/dhcp-relay/customer-dhcp-servers/server-ip-address	<p>The RFC 8299 Yang module treats DHCP Relay as part of the connection addressing. If the DHCP Relay Service Attribute contains any IPv4 addresses, this can be represented by setting ip-connection/ipv4/address-allocation-type to provider-dhcp-relay and filling in the parameters under dhcp-relay as follows. Note that the UNI Access Link IPv4 Connection Addressing is <i>Unnumbered</i> or <i>Static</i> in this case.</p> <ul style="list-style-type: none"> <li>• provider-address: first Primary Subnet Service Provider IPv4 Address from the UNI Access Link IPv4 Connection Addressing Service Attribute, if specified; otherwise not set.</li> <li>• mask: Primary Subnet IPv4 Prefix length from the UNI Access Link IPv4 Connection Addressing Service Attribute, if specified; otherwise not set.</li> <li>• customer-dhcp-services/server-ip-address: IPv4 Addresses from the UNI Access Link DHCP Relay Service Attribute.</li> </ul> <p>A similar approach can be taken if the DHCP Relay Service Attribute contains any IPv6 addresses.</p> <p>The IPVC EP Identifier cannot be represented in the yang module.</p>
UNI Access Link Prefix Delegation	No equivalent	Cannot be represented in the yang module.
UNI Access Link BFD	ip-connection/oam/bfd/...	<i>None</i> is represented by setting .../enabled to false, otherwise it is true.
<ul style="list-style-type: none"> <li>• Connection Address Family</li> </ul>	No equivalent	Cannot be represented in the Yang module.

Service Attribute	RFC 8299 Yang Node (under /l3vpn-svc/sites/site/site-network-accesses/site-network-access)	Notes
<ul style="list-style-type: none"> <li>• Transmission Interval</li> </ul>	No equivalent	Cannot be represented in the Yang module; however, the “hold time” (i.e. the Transmission Interval multiplied by the Detect Multiplier) can be specified using ../hold-time/fixed/fixed-value.
<ul style="list-style-type: none"> <li>• Detect Multiplier</li> </ul>	No equivalent	Cannot be represented in the Yang module; however, the “hold time” (i.e. the Transmission Interval multiplied by the Detect Multiplier) can be specified using ../hold-time/fixed/fixed-value.
<ul style="list-style-type: none"> <li>• Active End</li> </ul>	No equivalent	Cannot be represented in the Yang module.
<ul style="list-style-type: none"> <li>• Authentication Type</li> </ul>	No equivalent	Cannot be represented in the Yang module.
UNI Access Link IP MTU	service/svc-mtu	Equivalent.
UNI Access Link Ingress Bandwidth Profile Envelope	See section A.9	See section A.9.
UNI Access Link Egress Bandwidth Profile Envelope	See section A.9	See section A.9.
UNI Access Link Reserved VRIDs	No equivalent	Cannot be represented in the Yang module.
No equivalent	location-flavor	This choice is mandatory, but for a MEF IP Service a dummy value can be used.
No equivalent	access-diversity	Not used for MEF IP Services, as this relates to specification of constraints on the SP or Operator implementation (see introduction to Appendix A). It is always an empty list for MEF IP Services.
No equivalent	service/service-input-bandwidth	See section A.9.
No equivalent	service/service-output-bandwidth	See section A.9.

Service Attribute	RFC 8299 Yang Node (under /13vpn-svc/sites/site/site-network-accesses/site-network-access)	Notes
No equivalent	availability/access-priority	This node is used to specify active/standby or load-balancing between multiple site-network-accesses in a site. For MEF IP Services, that is controlled by setting routing protocol metrics appropriately. This is always unset for a MEF IP Service.
No equivalent	vpn-attachment	See section A.2.
No equivalent	service/qos/qos-profile	See section A.9.
No equivalent	Security	These nodes under the site-network-access in the Yang module duplicate equivalent nodes under the site. They are not used to represent a MEF IP Service; instead, the per-site versions are used where applicable, as described in section A.5.
No equivalent	service/qos/qos-classification-policy	
No equivalent	service/carrierscarrier/signalling-type	
No equivalent	service/multicast	
No equivalent	routing-protocols	

**Table 36 – UNI Access Link Service Attributes Comparison with RFC 8299**

### A.7 ENNI Service Attributes and ENNI Common Attributes

As described in section A.2, there is no direct equivalent in the Yang module for an ENNI, but each ENNI Service Mapping Context at an ENNI is represented in the Yang module by a site. Furthermore, the Yang module assumes that the SP/SO is the LLO on one side of the ENNI, and models the service provided by the LLO on the other side of the ENNI. For this reason, there is no distinction between ENNI Service Attributes (agreed between the SP/SO and each Operator) and ENNI Common Attributes (agreed between two LLOs), since the SP/SO is one of the LLOs.

Table 37 shows the ENNI Service Attributes defined in section 14, and how they can be represented in the Yang module. Table 38 shows the ENNI Common Attributes defined in section 15, and how they can be represented in the Yang module. In both cases, each ENNI Service Mapping Context at an ENNI is represented in the Yang module by a separate site. Table 38 also includes other nodes that are defined in the Yang module that do not correspond with MEF IP Service Attributes.

Service Attribute	RFC 8299 Yang Node (under /13vpn-svc/sites/site)	Notes
ENNI Identifier	No equivalent	Cannot be represented in the Yang module.



Service Attribute	RFC 8299 Yang Node (under /l3vpn-svc/sites/site)	Notes
ENNI Type	No equivalent	Cannot be represented in the Yang module; the Yang module assumes <i>Option A</i> .
ENNI Routing Information	routing-protocols/routing-protocol/...	The ENNI Routing Information for a given ENNI Service Mapping Identifier is represented in the Yang module by the corresponding site.
<ul style="list-style-type: none"> <li>Administrative Distance</li> </ul>	No equivalent	Cannot be represented in the Yang module.
<ul style="list-style-type: none"> <li>Route Flap Damping</li> </ul>	No equivalent	Cannot be represented in the Yang module.
<ul style="list-style-type: none"> <li>AS Override</li> </ul>	No equivalent	Cannot be represented in the Yang module.
<ul style="list-style-type: none"> <li>Static Routes: list of:               <ul style="list-style-type: none"> <li>Prefix</li> <li>Nexthop</li> <li>Admin Distance</li> </ul> </li> </ul>	.../static/cascaded-lan/prefixes/ipv4-lan-prefixes/... or .../static/cascaded-lan/prefixes/ipv6-lan-prefixes/... <ul style="list-style-type: none"> <li>.../lan</li> <li>.../next-hop</li> </ul>	Represented in the Yang module by an entry with type <i>Static</i> . RFC 8299 has separate lists for IPv4 and IPv6 routes. The admin distance cannot be represented in the yang module.
ENNI Ingress Bandwidth Profile Envelopes	See section A.9	The entry for each ENNI Service Mapping Identifier is represented in the Yang module by a QoS policy on each ENNI Link assigned to the corresponding ENNI Service Mapping Context. See section A.9.
ENNI Egress Bandwidth Profile Envelopes	See section A.9	The entry for each ENNI Service Mapping Identifier is represented in the Yang module by a QoS policy on each ENNI Link assigned to the corresponding ENNI Service Mapping Context. See section A.9.

**Table 37 – ENNI Service Attributes Comparison with RFC 8299**

Service Attribute	RFC 8299 Yang Node (under /l3vpn-svc/sites/site)	Notes
ENNI Peering Identifier	No equivalent	Cannot be represented in the Yang module.
ENNI Peering Type	No equivalent	Cannot be represented in the Yang module; the Yang module assumes <i>Option A</i> .

Service Attribute	RFC 8299 Yang Node (under /l3vpn-svc/sites/site)	Notes
ENNI List of ENNI Links	site-network-accesses/site-network-access/...	For each site, the ENNI Links assigned to the corresponding ENNI Service Mapping Context are listed in the Yang module.
<ul style="list-style-type: none"> <li>• ID</li> </ul>	.../bearer/bearer-reference	Equivalent, used to identify the underlying L1.
<ul style="list-style-type: none"> <li>• L1</li> </ul>	No equivalent	Cannot be represented in the Yang module.
<ul style="list-style-type: none"> <li>• Links</li> </ul>	.../site-network-access-id	Equivalent.
ENNI List of Control Protocols	No equivalent	Cannot be represented in the Yang module.
ENNI Routing Protocols	routing-protocols/routing-protocol/...	Equivalent.
<ul style="list-style-type: none"> <li>• Protocol</li> </ul>	.../type	<i>BGP</i> is equivalent. An entry for static is created in the Yang module based on the ENNI Routing Information Service Attribute (see Table 37). Other values defined in RFC 8299 (ospf, rip, vrrp, direct) are not used at an ENNI for MEF IP Services.
<ul style="list-style-type: none"> <li>• Address Family</li> </ul>	.../bgp/address-family	RFC 8299 uses a leaf-list containing one or both of IPv4 and IPv6 – a MEF IP Service with value <i>Both</i> is represented by including both IPv4 and IPv6 in the list.

Service Attribute	RFC 8299 Yang Node (under /l3vpn-svc/sites/site)	Notes
<ul style="list-style-type: none"> <li>• BGP               <ul style="list-style-type: none"> <li>○ First LLO's AS Number</li> <li>○ Second LLO's AS Number</li> <li>○ Connection Address Family</li> <li>○ Authentication</li> <li>○ First LLO's BGP Community List</li> <li>○ First LLO's BGP Extended Community List</li> <li>○ Second LLO's BGP Community List</li> <li>○ Second LLO's BGP Extended Community List</li> <li>○ Hold Time</li> <li>○ First LLO's Route Marking for Leaves</li> <li>○ Second LLO's Route Marking for Leaves</li> </ul> </li> </ul>	<p>.../bgp/... autonomous-system</p>	<p>The SP/SO's AS Number is represented by bgp/autonomous-system; other parameters of a MEF IP Service cannot be represented in the Yang module.</p>
ENNI Service Map	No equivalent	In the Yang module, each ENNI Service Mapping Context is represented by a different site; see section A.2.
No equivalent	site-id	No direct equivalent, but the ENNI Service Mapping Identifier can be represented by the site-id.
No equivalent	requested-site-start	Out of scope for MEF IP Service Attributes as this pertains to the use of the service not the definition of the service; it would be handled at the Product layer. This is always un-set for MEF IP Services.
No equivalent	requested-site-stop	Out of scope for MEF IP Service Attributes as this pertains to the use of the service not the definition of the service; it would be handled at the Product layer. This is always un-set for MEF IP Services.

Service Attribute	RFC 8299 Yang Node (under /l3vpn-svc/sites/site)	Notes
No equivalent	locations	Out of scope for MEF IP Service Attributes as this pertains to the use of the service not the definition of the service; it would be handled at the Product layer. It is always an empty list for MEF IP Services.
No equivalent	devices	Out of scope for MEF IP Service Attributes as this pertains to the use of the service not the definition of the service; it would be handled at the Product layer. It is always an empty list for MEF IP Services.
No equivalent	site-diversity	Not used for MEF IP Services, as this relates to specification of constraints on the SP or Operator implementation (see introduction to Appendix A). It is always an empty list for MEF IP Services.
No equivalent	management/type	Not applicable at an ENNI. For MEF IP Services, it is always set to customer-managed at an ENNI.
No equivalent	vpn-policies	See section A.2.
No equivalent	site-vpn-flavor	See section A.2.
No equivalent	maximum-routes	At an ENNI, this is equivalent to the IPVC EP Maximum IPv4/IPv6 routes for the IPVC EP with the ENNI Service Mapping Identifier corresponding to the site.
No equivalent	security	Not in scope for MEF IP Services. This is always empty for MEF IP Services.
No equivalent	service/qos/qos-classification-policy	See section A.4.1.
No equivalent	service/qos/qos-profile	See section A.9.
No equivalent	service/carrierscarrier/signalling-type	Not in scope for MEF IP Services. This is always unset for MEF IP Services.
No equivalent	service/multicast	Not in scope for MEF IP Services. This is always empty for MEF IP Services.
No equivalent	traffic-protection	This is a constraint on the SP or Operator implementation; for MEF IP Services, it is handled by specifying SLS objectives. Always unset for MEF IP Services.
No equivalent	actual-site-start (read-only)	Out of scope for MEF IP Service Attributes as this pertains to the use of the service not the definition of the service; it would be handled at the Product layer.

Service Attribute	RFC 8299 Yang Node (under /3vpn-svc/sites/site)	Notes
No equivalent	actual-site-stop (read-only)	Out of scope for MEF IP Service Attributes as this pertains to the use of the service not the definition of the service; it would be handled at the Product layer.

**Table 38 – ENNI Common Attributes Comparison with RFC 8299**

### A.8 ENNI Link Attributes

Each ENNI Link for a MEF IP Service can be represented in the RFC 8299 Yang module as a Site Network Access. Table 39 shows the ENNI Link Attributes defined in section 16, and how these can be represented in the Yang module. It also includes other nodes that are defined in the Yang module that do not correspond with MEF IP Service Attributes.

Service Attribute	RFC 8299 Yang Node (under /3vpn-svc/sites/site/site-network-accesses/site-network-access)	Notes
ENNI Link Identifier	site-network-access-id	Equivalent.
ENNI Link L2 Technology	bearer/	Although these are equivalent concepts, the parameters specified in the RFC 8299 Yang module are in the context of a request from the customer to the SP (or a SP/SO to an Operator), so may not be applicable to a MEF IP Service and are therefore not set. The Yang module notes that the bearer container is to be augmented with bearer-specific parameters; this is aligned with the UNI Access Link L2 Technology Service Attribute, for which the details are not specified in this document.
ENNI Link IPv4 Connection Addressing	ip-connection/ipv4/... .../address-allocation-type	<i>None</i> can be represented by not setting this leaf. <i>Static</i> is equivalent to static-address. Other values in the Yang module are not used for a MEF IP Service for an ENNI Link.

Service Attribute	RFC 8299 Yang Node (under /l3vpn-svc/sites/site/site-network-accesses/site-network-access)	Notes
<ul style="list-style-type: none"> <li>• Static               <ul style="list-style-type: none"> <li>○ Primary Subnet:                   <ul style="list-style-type: none"> <li>▪ IPv4 Prefix</li> <li>▪ First LLO IPv4 Address</li> <li>▪ Second LLO IPv4 Address</li> </ul> </li> <li>○ Secondary Subnets:                   <ul style="list-style-type: none"> <li>▪ IPv4 Prefix</li> <li>▪ First LLO IPv4 Address</li> <li>▪ Second LLO IPv4 Address</li> </ul> </li> </ul> </li> </ul>	<p>.../addresses/...</p> <ul style="list-style-type: none"> <li>• provider-address</li> <li>• customer-address</li> <li>• mask</li> </ul>	<p>The RFC 8299 Yang module provides equivalents for the Primary Subnet IPv4 Prefix, and the two IPv4 Addresses; the customer-address is the address of the LLO that is also SP/SO, and the provider-address is the address of the other LLO. Any Secondary Subnets cannot be represented in the Yang module.</p>
ENNI Link IPv6 Connection Addressing	<p>ip-connection/ipv6/... .../address-allocation-type</p>	<p><i>None</i> can be represented by not setting this leaf. <i>Static</i> is equivalent to static-address. There is no equivalent in the RFC 8299 Yang module for <i>LL-only</i>. A MEF IP Service using <i>LL-only</i> cannot be represented. Other values in the Yang module are not used for a MEF IP Service for an ENNI Link.</p>
<ul style="list-style-type: none"> <li>• Static               <ul style="list-style-type: none"> <li>○ Subnet List:                   <ul style="list-style-type: none"> <li>▪ IPv6 Prefix</li> <li>▪ First LLO IPv6 Addresses</li> <li>▪ Second LLO IPv6 Address</li> </ul> </li> </ul> </li> </ul>	<p>.../addresses/...</p> <ul style="list-style-type: none"> <li>• provider-address</li> <li>• customer-address</li> <li>• mask</li> </ul>	<p>The RFC 8299 Yang module provides equivalents for the first Subnet IPv6 Prefix, and the two IPv6 Addresses; the customer-address is the address of the LLO that is also SP/SO, and the provider-address is the address of the other LLO. Any further Subnets cannot be represented in the Yang module.</p>
ENNI Link BFD	ip-connection/oam/bfd/...	<p><i>None</i> is represented by setting .../enabled to false, otherwise it is true.</p>
• Connection Address Family	No equivalent	Cannot be represented in the Yang module.
• Transmission Interval	No equivalent	<p>Cannot be represented in the Yang module; however, the “hold time” (i.e. the Transmission Interval multiplied by the Detect Multiplier) can be specified using .../hold-time/fixed/fixed-value.</p>

Service Attribute	RFC 8299 Yang Node (under /l3vpn-svc/sites/site/site-network-accesses/site-network-access)	Notes
<ul style="list-style-type: none"> <li>Detect Multiplier</li> </ul>	No equivalent	Cannot be represented in the Yang module; however, the “hold time” (i.e. the Transmission Interval multiplied by the Detect Multiplier) can be specified using ../hold-time/fixed/fixed-value.
<ul style="list-style-type: none"> <li>Authentication Type</li> </ul>	No equivalent	Cannot be represented in the Yang module.
ENNI Link IP MTU	service/svc-mtu	Equivalent.
No equivalent	site-network-access-type	Always set to point-to-point for ENNI Links.
No equivalent	location-flavor	This choice is mandatory, but for a MEF IP Service a dummy value can be used.
No equivalent	access-diversity	Not used for MEF IP Services, as this relates to specification of constraints on the SP or Operator implementation (see introduction to Appendix A). It is always an empty list for MEF IP Services.
No equivalent	service/service-input-bandwidth	See section A.9.
No equivalent	service/service-output-bandwidth	See section A.9.
No equivalent	availability/access-priority	This node is used to specify active/standby or load-balancing between multiple site-network-accesses in a site. For MEF IP Services, that is controlled by setting routing protocol metrics appropriately. This is always unset for a MEF IP Service.
No equivalent	vpn-attachment	See section A.2.
No equivalent	service/qos/qos-profile	See section A.9.
No equivalent	security	These nodes under the site-network-access in the Yang module duplicate equivalent nodes under the site. They are not used to represent a MEF IP Service; instead, the per-site versions are used where applicable, as described in section A.7.
No equivalent	service/qos/qos-classification-policy	
No equivalent	service/carrierscarrier/signalling-type	
No equivalent	service/multicast	
No equivalent	routing-protocols	

**Table 39 – ENNI Link Attributes Comparison with RFC 8299**

## A.9 Bandwidth Profiles

Bandwidth Profiles are used to specify the temporal properties of a sequence of IP Packets that flow over a UNI. In RFC 8299, QoS Profiles are used for the same purpose; however, the QoS profiles described in RFC 8299 are much less flexible than the Bandwidth Profiles described in this document; consequently, there are only a few cases where a MEF IP Service with a Bandwidth Profile can be represented using the RFC 8299 Yang module.

A QoS profile corresponds with a Bandwidth Profile Envelope. QoS Profiles can be specified per site or per site-network access – a per-site QoS Profile can represent a UNI Bandwidth Profile Envelope, and a per-site-network-access QoS Profile can represent a UNI Access Link Bandwidth Profile Envelope. An ENNI Bandwidth Profile Envelope, which is applied separately to each ENNI Link for a given ENNI Service Mapping Context, can be represented by a per-site-network-access QoS Profile on each site network access for the site representing that ENNI Service Mapping Context.

IPVC EP Bandwidth Profile Envelopes cannot be represented directly in the Yang module. However, for an IPVC EP at a UNI, if the UNI has a single IPVC EP, the IPVC EP Bandwidth Profile Envelope is equivalent to a UNI Bandwidth Profile Envelope, which can be represented. For an IPVC EP at an ENNI, if there is only a single ENNI Link assigned to the ENNI Service Mapping Context corresponding to the ENNI Service Mapping Identifier for the IPVC EP, then the IPVC EP Bandwidth Profile Envelope is equivalent to an ENNI Bandwidth Profile Envelope, which can be represented.

Each QoS Profile has a direction, which is “Site-to-WAN”, “WAN-to-Site” or “both”. Ingress Bandwidth Profiles can be represented by setting the direction to “Site-to-WAN”. Egress Bandwidth Profiles can be represented by setting the direction to “WAN-to-Site”. The “both” direction is not used to represent MEF IP Services.

A QoS Profile is always defined with a flow per Class of Service. Therefore, only Bandwidth Profile Envelopes that contain one BWP Flow per CoS Name can be represented. This includes:

- UNI and UNI Access Link BWP Envelopes with BWP Flows defined using a list of (IPVC EP, CoS Name) pairs, where the list contains entries which all have the same value for CoS Name and include all the IPVC EPs at the UNI for IPVCs that use that CoS Name.
- IPVC EP and ENNI BWP Envelopes with BWP Flows defined using a set of CoS Names, where each such set contains a single CoS Name.
- BWP Flows that match all IP Packets for the BWP Envelope, if all the corresponding IPVC EPs use the same single CoS Name.

Note that there are several common cases where one of these conditions is met at a UNI:

- There is only one IPVC EP at a UNI, and each BWP Flow is defined per CoS Name.
- Every IPVC attached to the UNI uses different CoS Names, and each BWP Flow is defined using a single (IPVC EP, CoS Name) pair.



- Every IPVC attached to the UNI uses the same CoS Names, and each BWP Flow is defined by including an (IPVC EP, CoS Name) pair for a given CoS Name for every IPVC EP at the UNI.

A common case at an ENNI where one of these conditions is met is when there is a BWP Flow defined per CoS Name.

A Bandwidth Profile Envelope has two parameters, in addition to the list of BWP Flows: the Envelope MaxIR and the Envelope IR Time. The Envelope Maximum IR (*MaxIRE*) can be represented by the service-input-bandwidth and service-output-bandwidth as shown in Table 40. The Envelope IR Time has no equivalent and cannot be represented in the Yang module.

MEF IP Service Attribute	Representation of MaxIRE in the RFC 8299 Yang module
UNI Ingress Bandwidth Profile Envelope	MaxIRE can be represented by setting /13vpn-svc/sites/site/site-network-accesses/site-network-access/service/svc-output-bandwidth to MaxIRE/N on each site-network-access in the site, where N is the number of UNI Access Links in the UNI. Note that svc-output-bandwidth can only be specified per site-network-access, but the QoS Profile is applied to the aggregate across all site network accesses.
UNI Egress Bandwidth Profile Envelope	MaxIRE can be represented by setting /13vpn-svc/sites/site/site-network-accesses/site-network-access/service/svc-input-bandwidth to MaxIRE/N on each site-network-access in the site, where N is the number of UNI Access Links in the UNI. Note that svc-input-bandwidth can only be specified per site-network-access, but the QoS Profile is applied to the aggregate across all site network accesses.
UNI Access Link Ingress Bandwidth Profile Envelope	MaxIRE can be represented by setting /13vpn-svc/sites/site/site-network-accesses/site-network-access/service/svc-output-bandwidth to MaxIRE on the site-network-access that represents the UNI Access Link.
UNI Access Link Egress Bandwidth Profile Envelope	MaxIRE can be represented by setting /13vpn-svc/sites/site/site-network-accesses/site-network-access/service/svc-input-bandwidth to MaxIRE on the site-network-access that represents the UNI Access Link.
ENNI Ingress Bandwidth Profile Envelope (BWP Envelope per ENNI Link)	MaxIRE can be represented by setting /13vpn-svc/sites/site/site-network-accesses/site-network-access/service/svc-output-bandwidth to MaxIRE on the site-network-access that represents the ENNI Link.
ENNI Egress Bandwidth Profile Envelope (BWP Envelope per ENNI Link)	MaxIRE can be represented by setting /13vpn-svc/sites/site/site-network-accesses/site-network-access/service/svc-input-bandwidth to MaxIRE on the site-network-access that represents the ENNI Link.

**Table 40 – Representing Envelope MaxIR using QoS Profiles**

A QoS Profile can be either a “standard” profile or a “custom” profile. For MEF IP Services, the “custom” option is used. Table 41 shows how Bandwidth Profile Flow parameters are related to QoS Profile parameters.

<b>Bandwidth Profile Flow parameter</b>	<b>RFC 8299 Yang Node (under /l3vpn-svc/sites/site/service/qos/qos-profile/qos-profile/custom/classes/class)</b>	<b>Notes</b>
Flow Definition	class-id	As described above, only Envelopes that contain flows defined for a given CoS Name and all IPVC EPs can be represented; therefore it is sufficient to specify the CoS Name, which is equivalent to the class id.
Flow Identifier	No equivalent	Cannot be represented in the Yang module.
Committed Information Rate	bandwidth/guaranteed-bw-percent	Equivalent; but note that the Yang module is specified as a percentage rather than an absolute value.
Maximum Information Rate	rate-limit	Equivalent; but note that the Yang module is specified as a percentage rather than an absolute value.
Weight	No equivalent	Cannot be represented in the Yang module.
Burst Behavior	No equivalent	Cannot be represented in the Yang module.
No equivalent	direction	Indicates whether the QoS Policy applies to ingress or egress traffic, i.e. whether it represents an Ingress or Egress Bandwidth Profile; see above.
No equivalent	latency	Not applicable in a MEF IP Service since performance objectives are specified in the SLS. This is always unset for a MEF IP Service.
No equivalent	jitter	Not applicable in a MEF IP Service since performance objectives are specified in the SLS. This is always unset for a MEF IP Service.
No equivalent	bandwidth/end-to-end	Not applicable in a MEF IP Service since performance objectives are specified in the SLS. This is always false for a MEF IP Service.

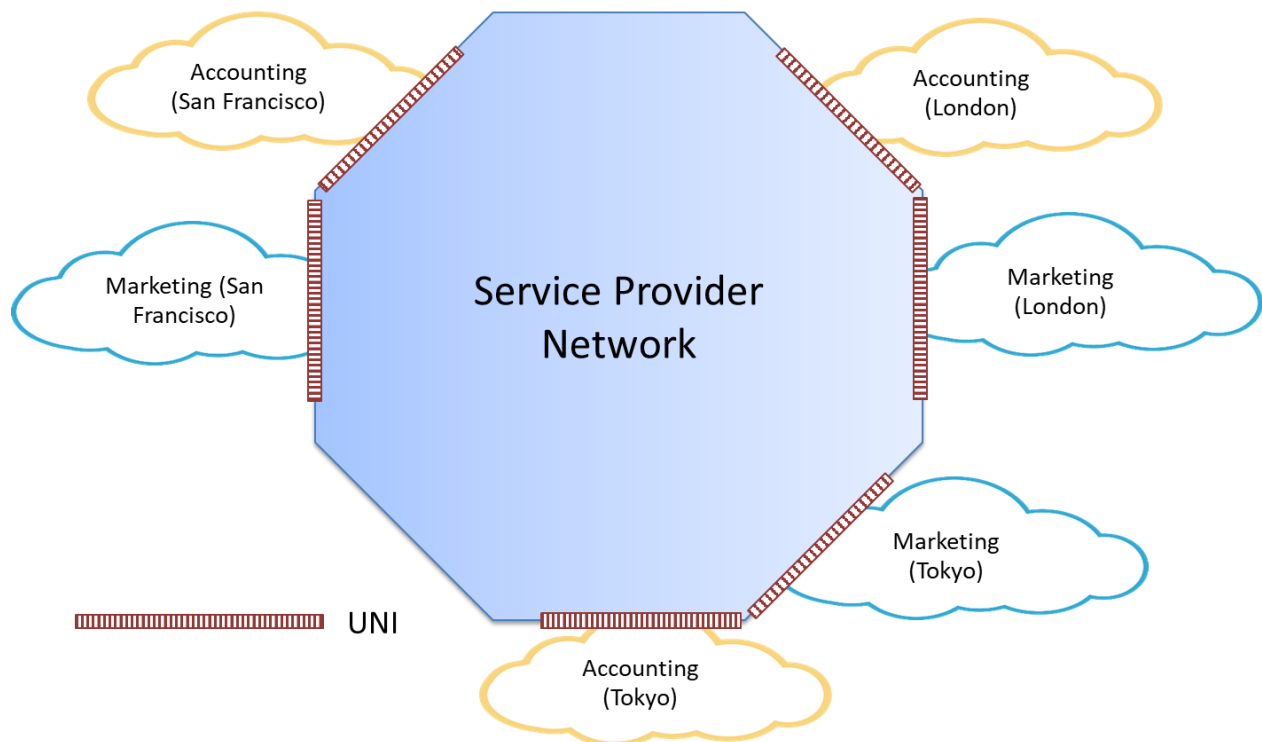
**Table 41 – Bandwidth Profile Flow Parameter Comparison with RFC 8299**

## Appendix B Examples for Subscriber IP Services (Informative)

This Appendix contains several examples showing the use of various Service Attributes to implement different aspects of Subscriber IP Services. Note that these examples use IPv4 Documentation Space per RFC 5737 [42].

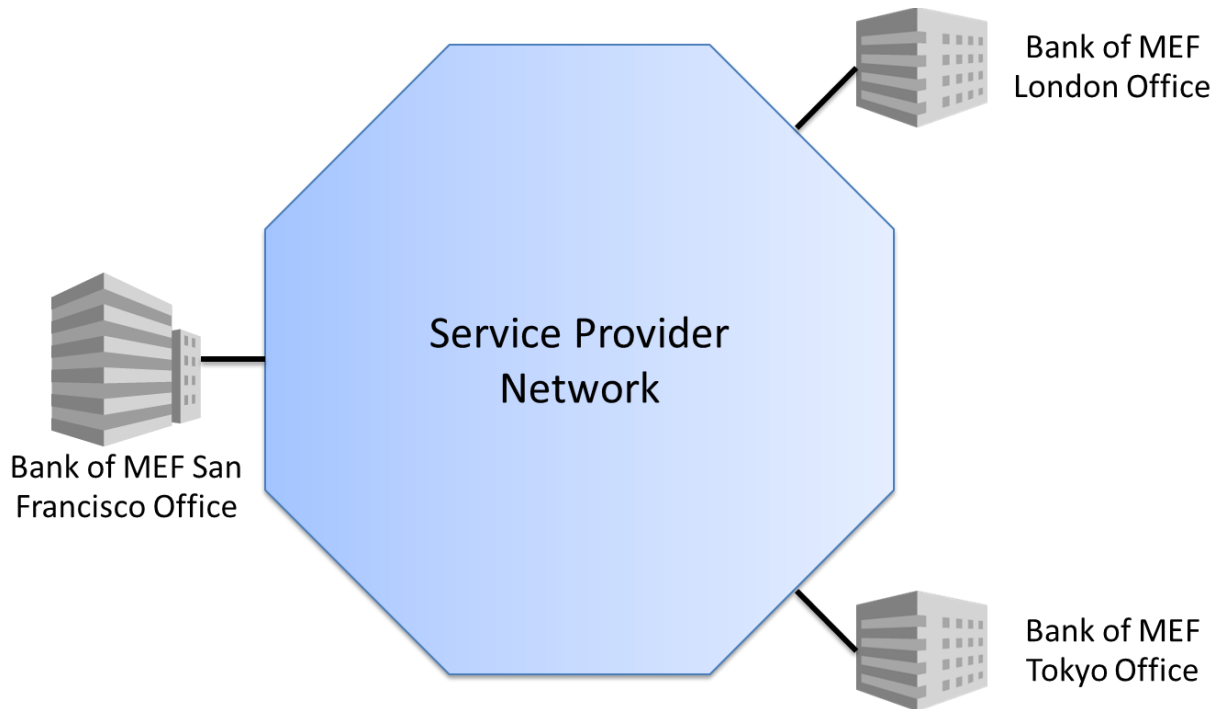
### B.1 Multiple Subscriber Networks

This section describes an example where a Subscriber, Bank of MEF, has two departments, accounting and marketing, that have separate IP networks. These use IP addresses within same IP Prefix space, but are separated at Layer 2 by the use of Ethernet VLANs. Bank of MEF has offices in several locations, each of which has both accounting and marketing functions, and so they obtain IP Services from a Service Provider to connect the accounting and marketing networks at the various locations together. The accounting and marketing networks are separate Subscriber Networks and hence are connected using distinct UNIs. Figure 31 shows a logical view of the UNIs connecting to the Subscriber Networks.



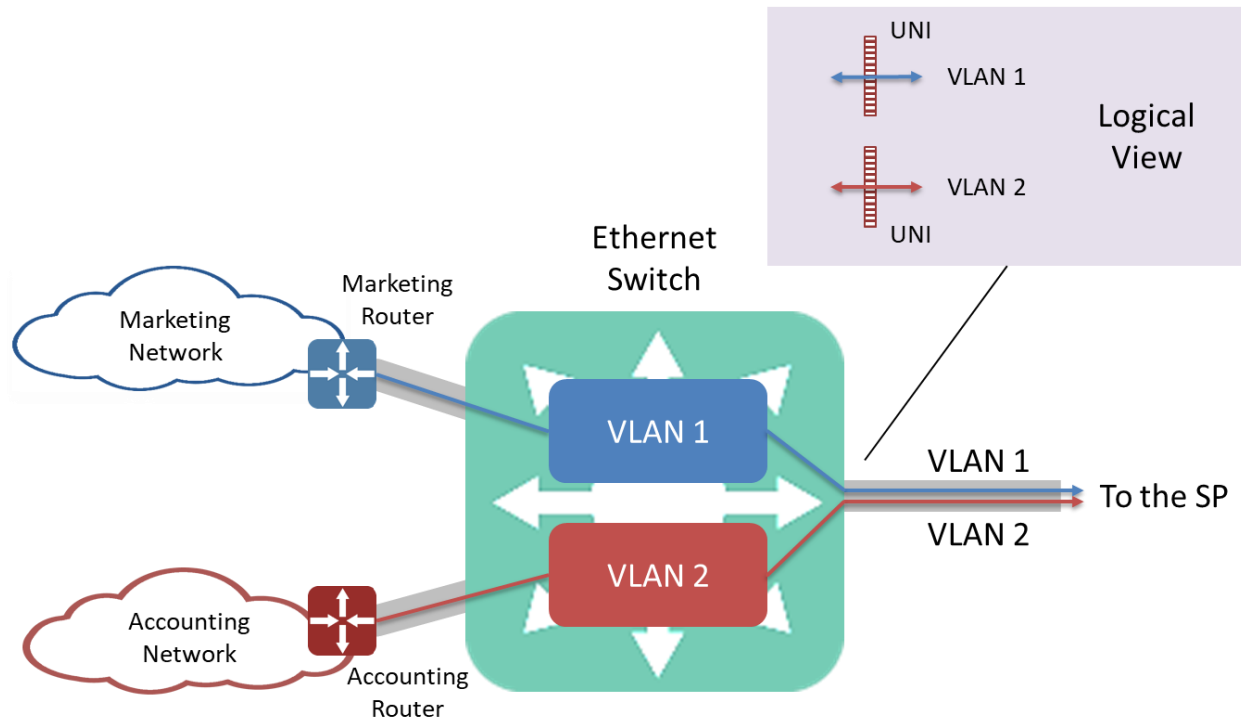
**Figure 31 – Example of Multiple Subscriber Networks – Logical View**

Physically, Bank of MEF connects to the Service Provider with a single physical Ethernet link in each location. Figure 32 shows the physical topology.



**Figure 32 – Example of Multiple Subscriber Networks – Physical Topology**

At each location, there are two UNIs. Each UNI contains a single UNI Access Link, which is implemented using a different Ethernet VLAN on the same physical Ethernet link that connects that location to the SP Network. Bank of MEF uses an Ethernet switch to separate IP traffic on the two VLANs and direct it to two different routers for the accounting and marketing networks. Figure 33 shows an example of this setup at one of the locations.

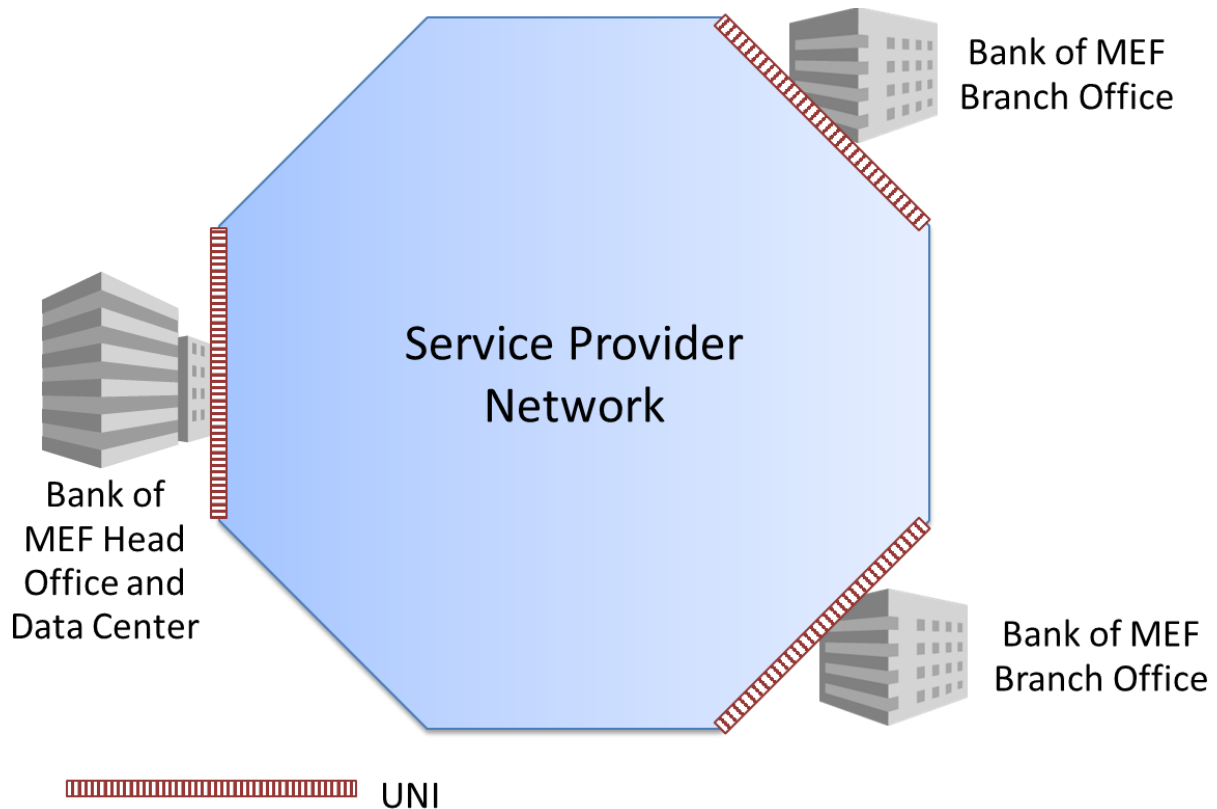


**Figure 33 – Example of Multiple Subscriber Networks – Setup at one Location**

Note that the example shown above is distinct from the case where different VLANs are used to create multiple UNI Access Links that connect to the same Subscriber Network. In the example above, there are two independent Subscriber Networks, for the two different departments in Bank of MEF.

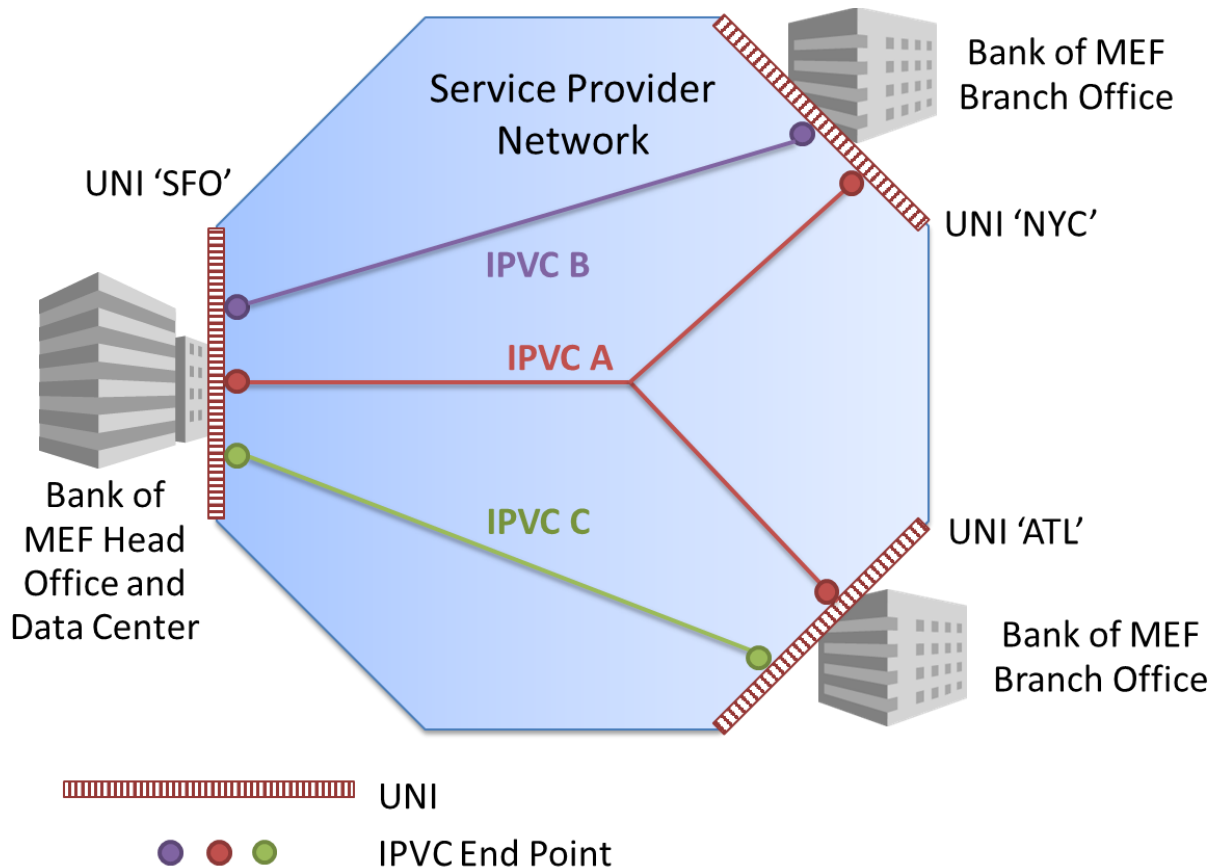
## B.2 Packet Delivery with Multiple Subscriber IPVCs

Figure 34 shows a Subscriber, Bank of MEF, who has three sites, and wants to connect them together using an IP Service. One site is the head office and also houses a private data center; the other two sites are branches.



**Figure 34 – Example IP Service**

Bank of MEF wants to generally connect their head office and branches together. They also want a dedicated connection from each branch to the private data center, with a stricter SLA (lower latency and higher guaranteed bandwidth). They therefore decide to obtain three IPVCs from the SP, as shown in Figure 35.



**Figure 35 – Example IP Service Showing Three IPVCs**

IPVC A (in red) connects all the sites together. IPVCs B and C (in purple and green) connect each branch to the data center, and have a stricter SLA.

Bank of MEF agrees with the SP that they will use OSPF at each UNI (per the UNI Routing Protocols Service Attribute, section 12.7). Bank of MEF uses this to advertise the IP Prefixes reachable at each site to the SP, as follows:

- UNI 'SFO':
  - Head Office subnet: 192.0.2.0/26
  - Data Center subnet: 203.0.113.0/24
- UNI 'NYC':
  - Branch subnet: 192.0.2.64/26
- UNI 'ATL':
  - Branch subnet: 192.0.2.128/26

To ensure traffic is routed over the correct IPVC, Bank of MEF also agrees to use a prefix mapping for each IPVC EP at UNI 'SFO' (per the IPVC EP Prefix Mapping Service Attribute, section 11.5), as follows:

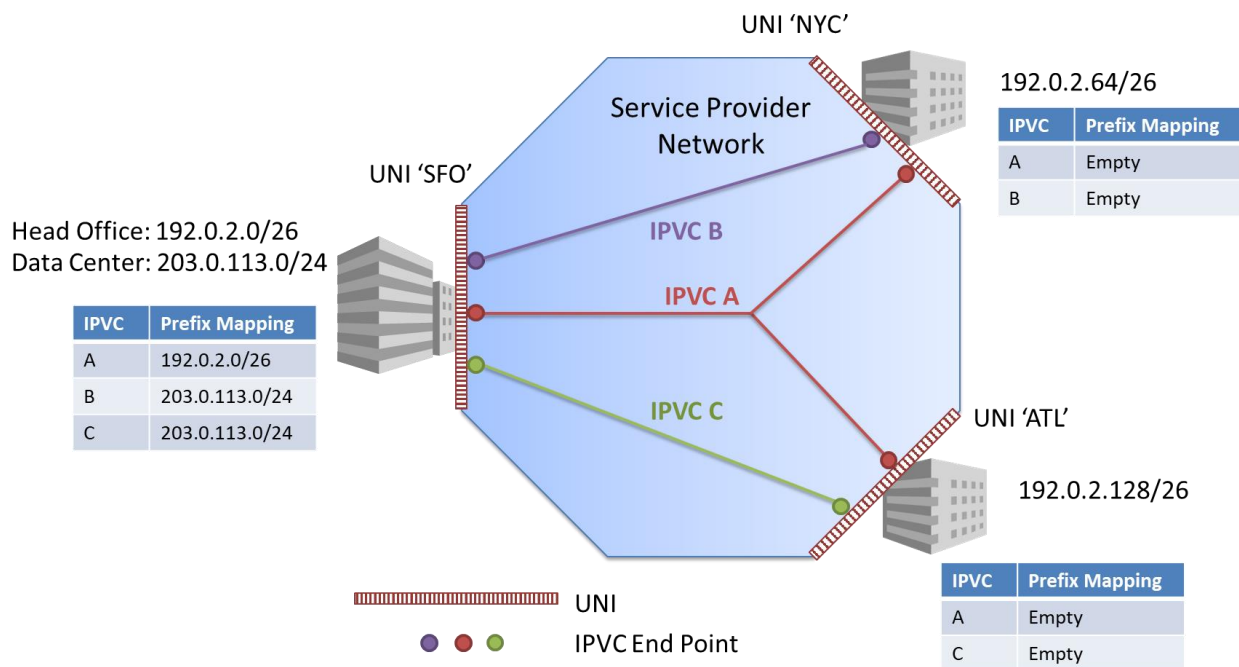
- IPVC EP for IPVC A:
  - IPVC EP Prefix Mapping: 192.0.2.0/26

- IPVC EP for IPVC B:
  - IPVC EP Prefix Mapping: 203.0.113.0/24
- IPVC EP for IPVC C:
  - IPVC EP Prefix Mapping: 203.0.113.0/24

The effect of this is that at UNI ‘SFO’, only hosts in the head office subnet can access IPVC A, and only hosts in the data center subnet can access IPVCs B and C.

No prefix mapping is used at UNI ‘NYC’ or UNI ‘ATL’ – that is, the IPVC EP Prefix Mapping is an empty list for each of the IPVC EPs at those UNIs. This means that hosts in each branch office can access any of the IPVCs that have IPVC EPs at the corresponding UNI.

This is shown in Figure 36:



**Figure 36 – Example IP Service – Subnets and Prefix Mapping**

All of the IPVCs use Standard IP Routing for packet delivery (section 10.4). For the purpose of illustration, we will assume initially that the SP implements this using the routing information databases described in section 9 (other possibilities are discussed below). Figure 37 shows the contents of  $RID_{UNI}$  at each UNI and  $RID_L$  at each IPVC EP. Recall that  $RID_L$  contains the same routes as  $RID_{UNI}$  if the IPVC EP Prefix Mapping Service Attribute is not set (i.e. at UNIs ‘NYC’ and ‘ATL’), and otherwise the subset of routes in  $RID_{UNI}$  that match the prefix mapping (i.e. at UNI ‘SFO’).



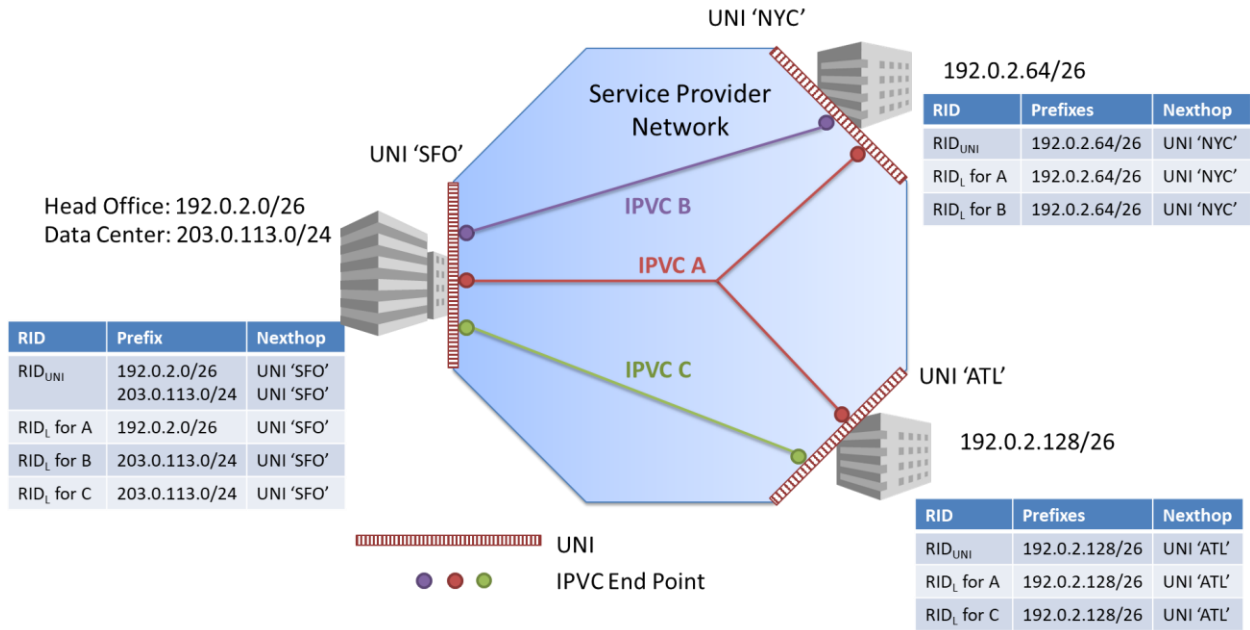


Figure 37 – Example IP Service – Reachable Prefixes

In order to deliver IP Packets per the requirements in section 10.4, the SP distributes the information about the IP Prefixes that are reachable at each IPVC EP to all other IPVC EPs for the IPVC. This allows RT<sub>IPVCEP</sub> to be constructed for each IPVC EP, as shown in Figure 38.

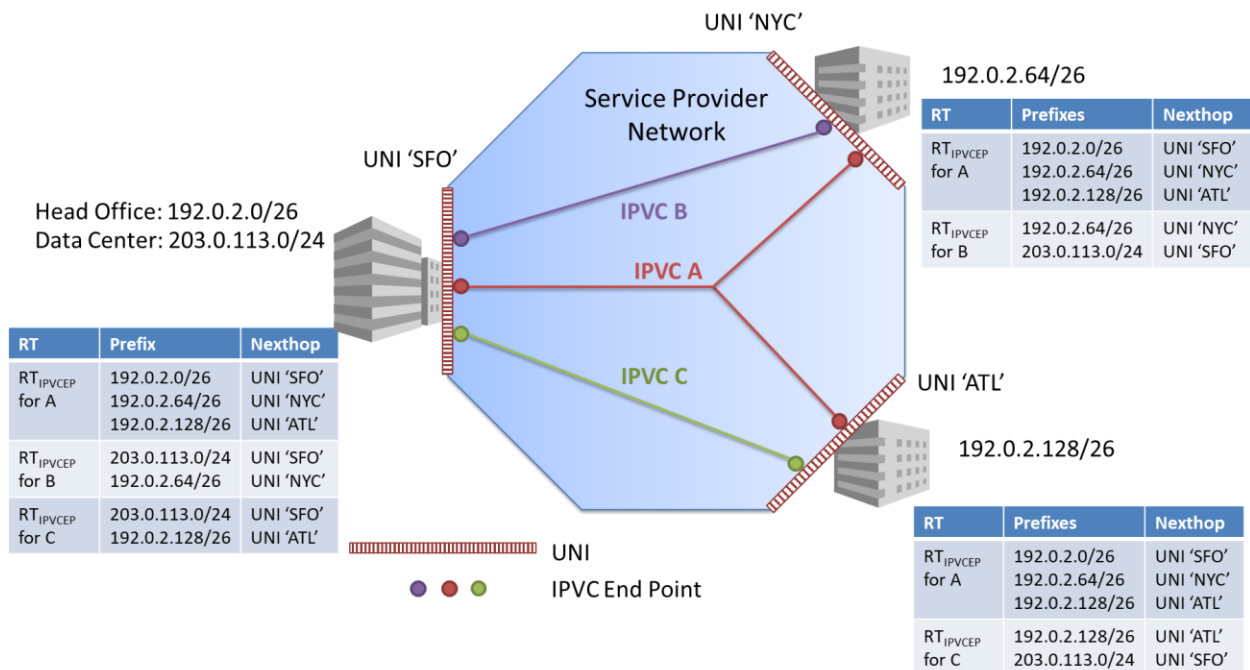


Figure 38 – Example IP Service – Per-IPVC EP Routing

To illustrate how packet delivery works, consider the handling of the following IP Packets. Recall that, in this example, OSPF is used at each UNI by the Subscriber to advertise the IP Prefixes that are reachable at that UNI.

- Ingress IP Packet at UNI ‘SFO’, source address 192.0.2.1, destination address 192.0.2.65:
  - At UNI ‘SFO’, due to the prefix mapping, a packet with source address 192.0.2.1 can only access IPVC A.
  - Looking at the IP Prefixes that are reachable via IPVC A, the destination 192.0.2.65 matches the IP Prefix 192.0.2.64/26, which can only be reached via the IPVC EP at UNI ‘NYC’.
  - Therefore, the packet is mapped to IPVC A and delivered to UNI ‘NYC’.
- Ingress IP Packet at UNI ‘SFO’, source address 203.0.113.1, destination address 192.0.2.129:
  - At UNI ‘SFO’, due to the prefix mapping, a packet with source address 203.0.113.1 can access IPVC B or IPVC C.
  - Looking at the IP Prefixes reachable via IPVC B and IPVC C, the destination address 192.0.2.129 is only reachable in IPVC C, via UNI ‘ATL’.
  - Therefore, the packet is mapped to IPVC C and delivered to UNI ‘ATL’.
- Ingress IP Packet at UNI ‘NYC’, source address 192.0.2.65, destination address 203.0.113.1:
  - The prefix mapping at UNI ‘NYC’ is empty, so the packet can access both IPVC A and IPVC B (as they have IPVC EPs at the UNI).
  - Looking at the IP Prefixes reachable via IPVC A and IPVC B, the destination address 203.0.113.1 is only reachable in IPVC B, via UNI ‘SFO’.
  - Therefore, the packet is mapped to IPVC B and delivered to UNI ‘SFO’.
- Ingress IP Packet at UNI ‘ATL’, source address 192.0.2.129, destination address 192.0.2.1:
  - The prefix mapping at UNI ‘ATL’ is empty, so the packet can access both IPVC A and IPVC C (as they have IPVC EPs at the UNI).
  - Looking at the IP Prefixes reachable via IPVC A and IPVC C, the destination address 192.0.2.1 is only reachable in IPVC A, via UNI ‘SFO’.
  - Therefore, the packet is mapped to IPVC A and delivered to UNI ‘SFO’.
- Ingress IP Packet at UNI ‘NYC’, source address 192.0.2.65, destination address 192.0.2.66:
  - The prefix mapping at UNI ‘NYC’ is empty, so the packet can access both IPVC A and IPVC B (as they have IPVC EPs at the UNI).
  - Looking at the IP Prefixes reachable via IPVC A and IPVC B, the destination address 192.0.2.66 is reachable in both of them, via UNI ‘NYC’.
  - Therefore, the packet can be mapped to either IPVC A or IPVC B, but in either case is transmitted back out of UNI ‘NYC’.

It can be seen that both the source and destination addresses in each Ingress IP Packet need to be considered in order to determine the correct IPVC to map the packet to, and the correct IPVC EP for that IPVC to deliver it to.

Looking again at Figure 38, it can be noted that whenever the same IP Prefix is present in two or more  $RT_{IPVCEP}$  routing tables for IPVC EPs at the same UNI, the nexthop also points to the same

UNI. For example, prefix 192.0.2.64/26 is present in RT<sub>IPVCEP</sub> for both IPVC EPs A and B at UNI ‘SFO’, and in both cases the nexthop is UNI ‘NYC’. This property is required in certain cases due to [R79]. It means that the separate routing tables per IPVC EP could in fact be combined into a single routing table at the UNI, since whenever there is a duplicate prefix, the nexthop is also the same (or at least, points to a UNI Access Link in the same UNI). This is shown in Figure 39.

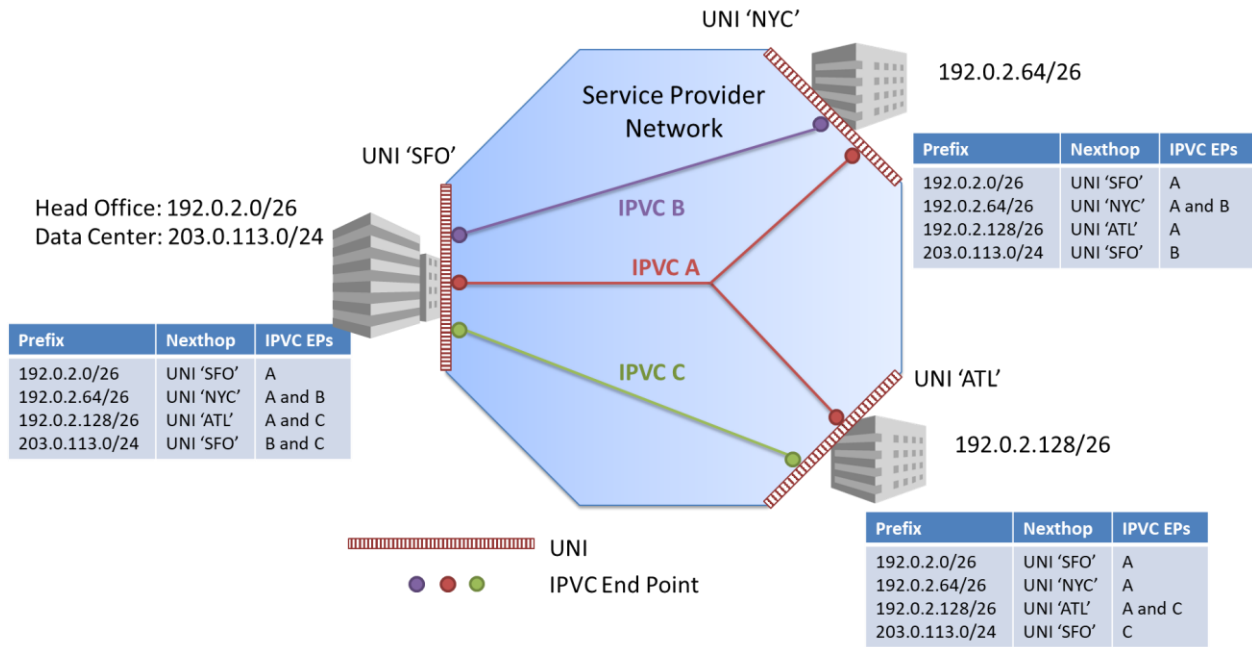


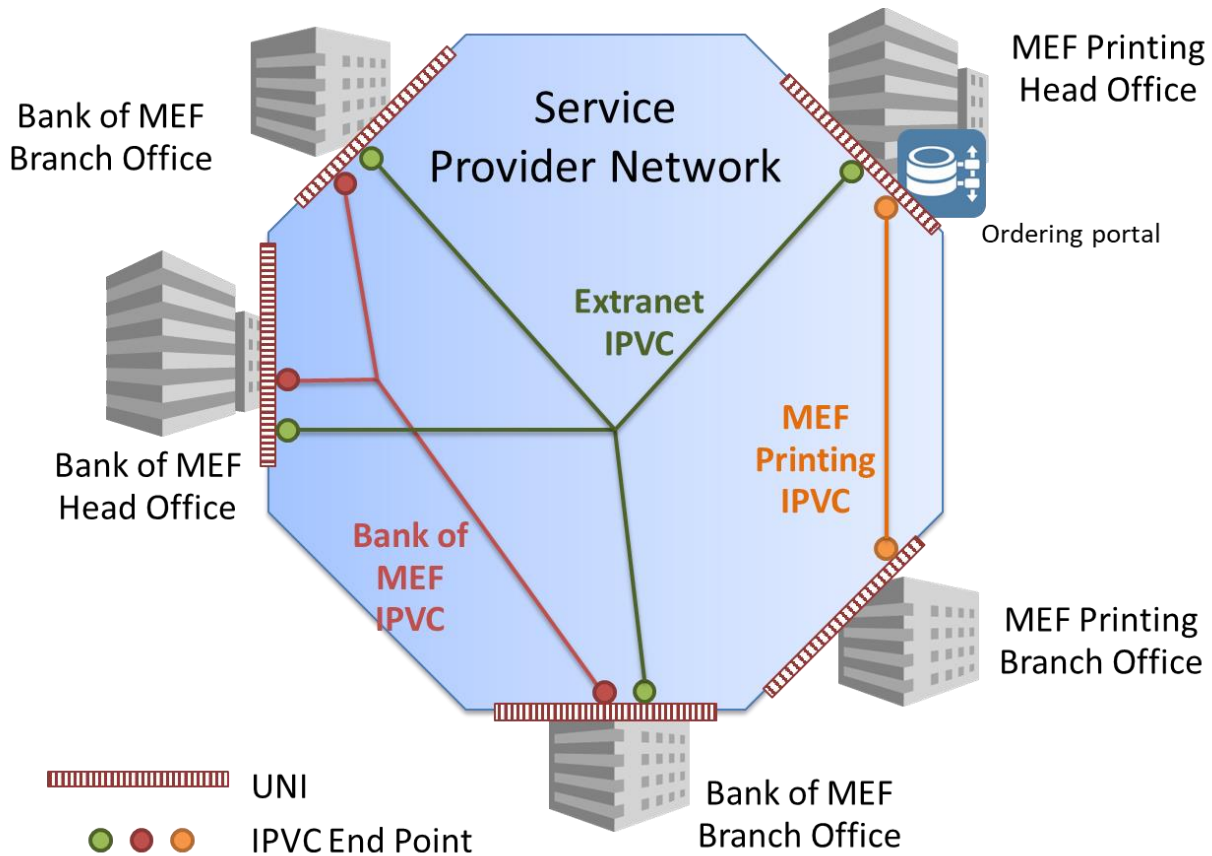
Figure 39 – Example IP Service – Combined Routing

Using this combined routing table, the handling of packets described above could be reversed: rather than considering the prefix mapping and only then looking up the routes, the route lookup can be done first and only then is the prefix mapping considered. For example, consider again an Ingress IP Packet at UNI ‘SFO’, with source address 192.0.2.1 and destination address 192.0.2.65. As shown in the combined routing table, this can be reached through UNI ‘NYC’ via either IPVC EP A or IPVC EP B. The IPVC EP Prefix Mapping for these two IPVC EPs can then be examined: the source address 192.0.2.1 is only included in the prefixes for IPVC A, so the packet is mapped to IPVC EP A, and consequently the SLS for IPVC A is applied.

Note that this document does not recommend any particular implementation, and neither of the approaches described here are mandatory. Any implementation that exhibits the correct behavior is acceptable.

### B.3 Packet Delivery with an Extranet

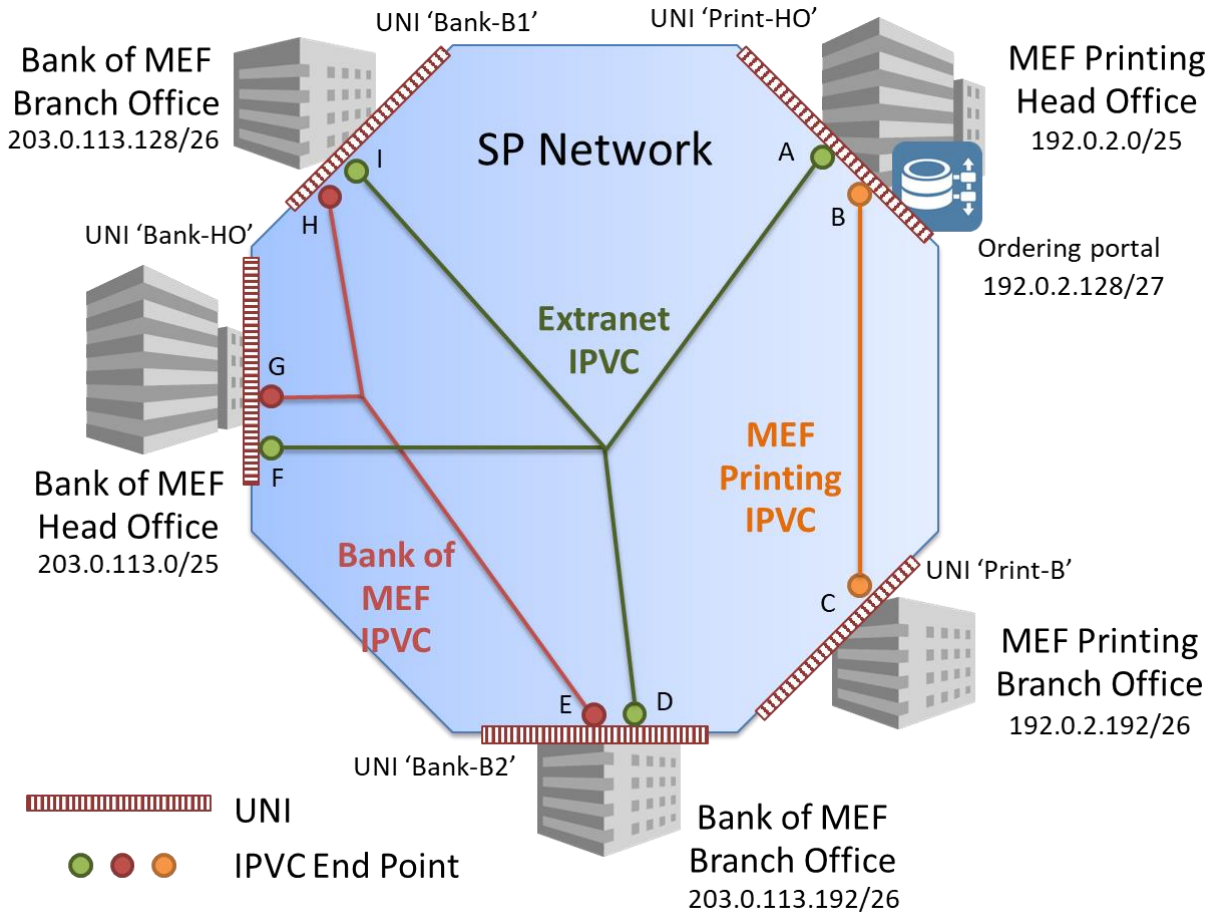
Figure 40 shows the example introduced in section 7.8, where two Subscribers have an extranet between them. In this example, an enterprise “Bank of MEF” needs to access an ordering portal in one of their suppliers, “MEF Printing”.



**Figure 40 – Extranet Example showing IPVCs**

As shown, each enterprise has their own Subscriber IPVC, and a third Subscriber IPVC is instantiated for the extranet. In this case, the green extranet IPVC is a rooted multipoint IPVC, with a root at MEF Printing’s ordering portal, and leaves at Bank of MEF’s offices. This prevents the extranet IPVC from being used for traffic between Bank of MEF’s offices, which should use their own IPVC (shown in red).

Figure 41 shows the IP Prefixes used at each site. Both Bank of MEF and MEF Printing use OSPF to advertise these IP Prefixes to the SP at each UNI, per the UNI Routing Protocols Service Attribute (section 12.7).



**Figure 41 – Extranet Example showing IP Prefixes**

At UNI 'Print-HO', MEF Printing additionally agrees on a prefix mapping for IPVC EP 'A' for the Extranet IPVC, using the IPVC EP Prefix Mapping Service Attribute (section 11.5). This enables Bank of MEF to access the ordering portal via the extranet IPVC, but prevents them accessing MEF Printing's head office network. Similarly, it allows the ordering portal to access Bank of MEF, but prevents hosts in the MEF Printing head office from accessing Bank of MEF.

The relevant Service Attributes are shown in Table 42.

IPVC / IPVC EP	Service Attribute	Value
Bank of MEF (red)	IPVC Topology	Multipoint
	IPVC Packet Delivery	Standard Routing
G (Bank of MEF at UNI 'Bank-HO')	IPVC EP Role	Root
	IPVC EP Prefix Mapping	[ ]
H (Bank of MEF at UNI 'Bank-B1')	IPVC EP Role	Root
	IPVC EP Prefix Mapping	[ ]
E (Bank of MEF at UNI 'Bank-B2')	IPVC EP Role	Root
	IPVC EP Prefix Mapping	[ ]
MEF Printing (orange)	IPVC Topology	Multipoint
	IPVC Packet Delivery	Standard Routing
B (MEF Printing at UNI 'Print-HO')	IPVC EP Role	Root
	IPVC EP Prefix Mapping	[ ]
C (MEF Printing at UNI 'Print-B')	IPVC EP Role	Root
	IPVC EP Prefix Mapping	[ ]
Extranet (green)	IPVC Topology	Rooted Multipoint
	IPVC Packet Delivery	Standard Routing
A (Extranet at UNI 'Print-HO')	IPVC EP Role	Root
	IPVC EP Prefix Mapping	[ 192.0.2.128/27 ]
F (Extranet at UNI 'Bank-HO')	IPVC EP Role	Leaf
	IPVC EP Prefix Mapping	[ ]
I (Extranet at UNI 'Bank-B1')	IPVC EP Role	Leaf
	IPVC EP Prefix Mapping	[ ]
D (Extranet at UNI 'Bank-B2')	IPVC EP Role	Leaf
	IPVC EP Prefix Mapping	[ ]

**Table 42 – Selected Service Attributes for an Extranet**

For the purpose of illustration, we assume that the SP implements their network using the routing information databases described in section 9. Given the attribute values above, Figure 42 shows the contents of  $RID_{UNI}$  at each UNI and  $RID_L$  at each IPVC EP. Recall that  $RID_L$  contains the same routes as  $RID_{UNI}$  if the IPVC EP Prefix Mapping Service Attribute is not set, and otherwise the subset of routes in  $RID_{UNI}$  that match the prefix mapping (i.e. at the Extranet IPVC EP 'A' at UNI 'Print-HO').

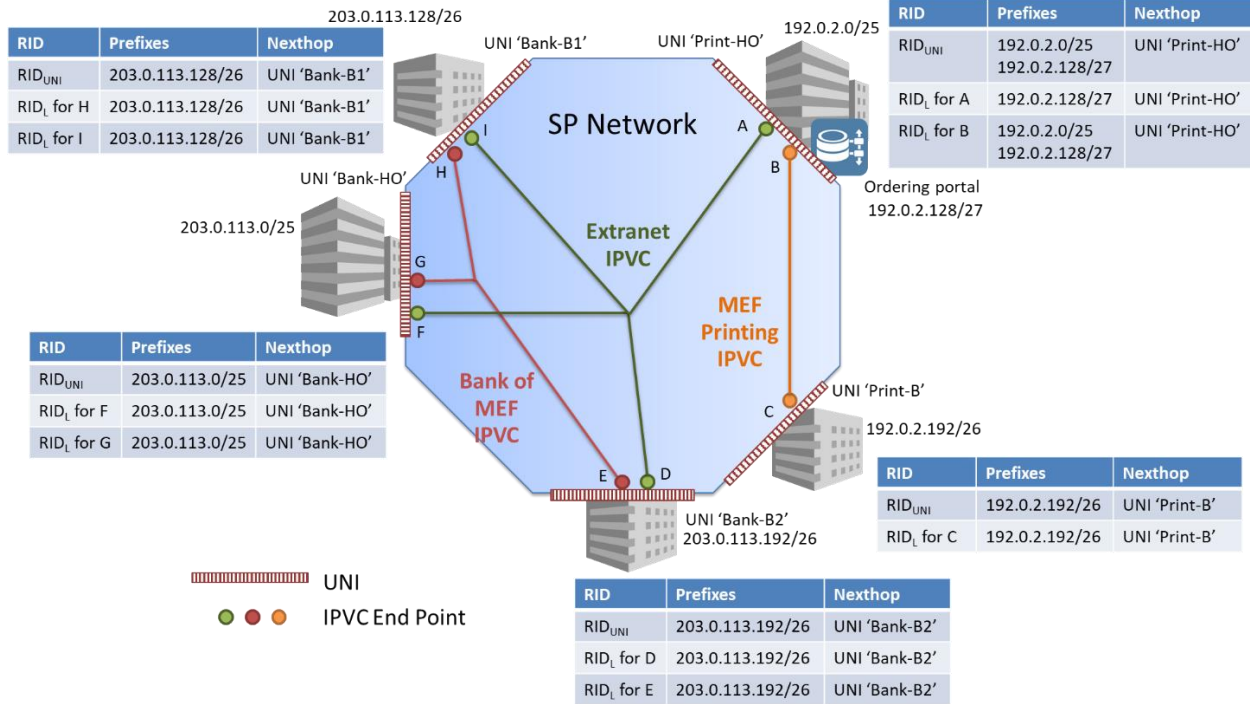


Figure 42 – Extranet Example showing Routing Information Databases

In order to deliver IP Packets per the requirements in section 10.4, the SP distributes the information about the IP Prefixes that are reachable at each IPVC EP to other IPVC EPs for the IPVC. Note that IP Prefixes are not distributed from leaf IPVC EPs to other leaf IPVC EPs – this affects IPVC EPs D, F and I in the Extranet IPVC. The distribution allows RT<sub>IPVCEP</sub> to be constructed for each IPVC EP, as shown in Figure 43.

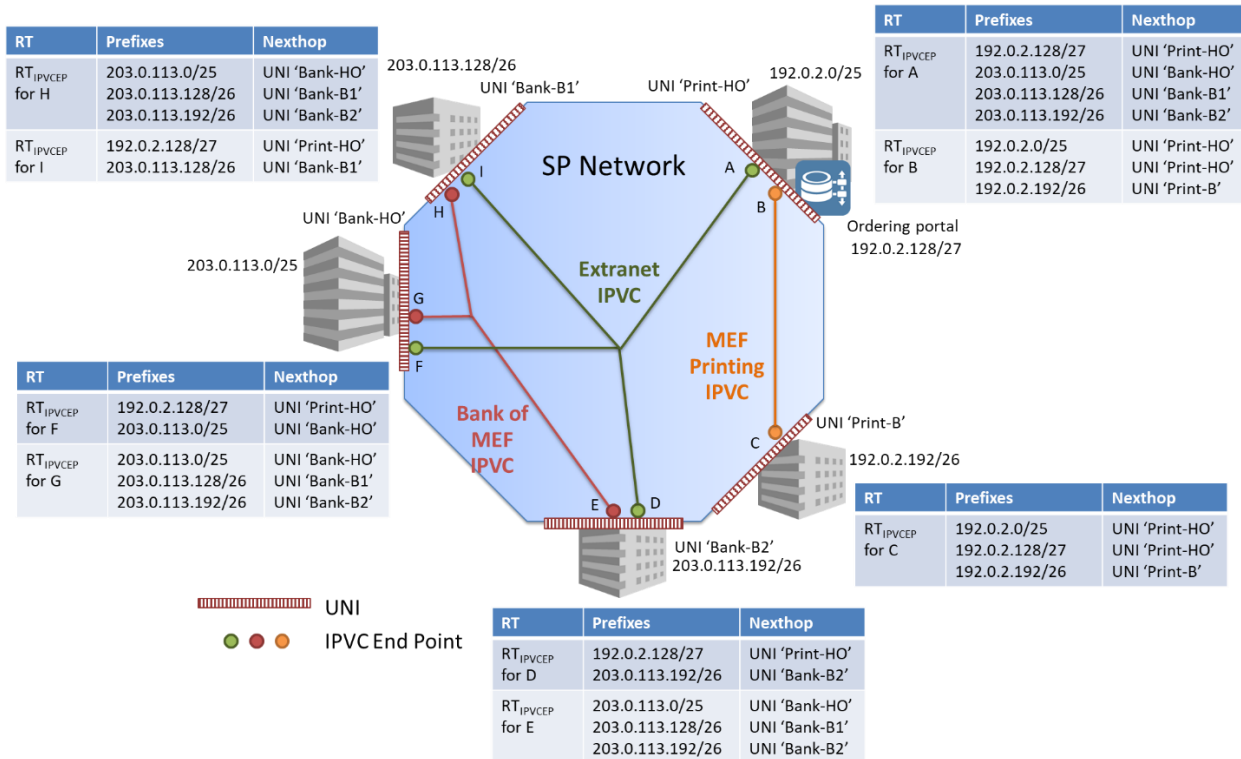


Figure 43 – Extranet Example showing Routing Tables

Note that the RT<sub>IPVCEP</sub> for IPVC EPs E, G and H in the Bank of MEF IPVC are all the same; and likewise, the RT<sub>IPVCEP</sub> for IPVC EPs B and C in the MEF Printing IPVC are the same. The interesting case is the Extranet IPVC. IPVC EPs D, F and I each contain a route toward their local UNI, and a route towards the ordering portal at UNI 'Print-HO', in their RT<sub>IPVCEP</sub>. They don't contain routes towards each other because the Extranet IPVC is a rooted multipoint IPVC, and IPVC EPs D, F and I are all leaves. They don't contain a route towards the MEF Printing head office (192.0.2.0/25) because the IPVC EP Prefix Mapping at IPVC EP A prevents this route being exposed to the Extranet IPVC. For the same reason, RT<sub>IPVCEP</sub> for IPVC EP A does not contain that route either; however, as it is a root, it does contain routes to all of the Bank of MEF UNIs.

The distribution of routing information as described above prevents hosts in Bank of MEF accessing any subnets in MEF Printing other than the ordering portal – it can be seen that at the Bank of MEF UNIs, there is simply no route present to the other IP Prefixes for MEF Printing. However, the IPVC EP Prefix Mapping at IPVC EP A also prevents hosts in MEF Printing (other than the ordering portal) from accessing Bank of MEF. For example, an IP Packet received at UNI 'Print-HO' with a source address of 192.0.2.1 and a destination of 203.0.113.1 is not mapped to IPVC EP A, even though IPVC EP A has a route to that destination, because the source address does not match the IPVC EP Prefix Mapping. The packet cannot be mapped to IPVC EP B either (as that does not have a route to the destination), and hence it is discarded.

#### B.4 Packet Delivery with Multiple UNIs

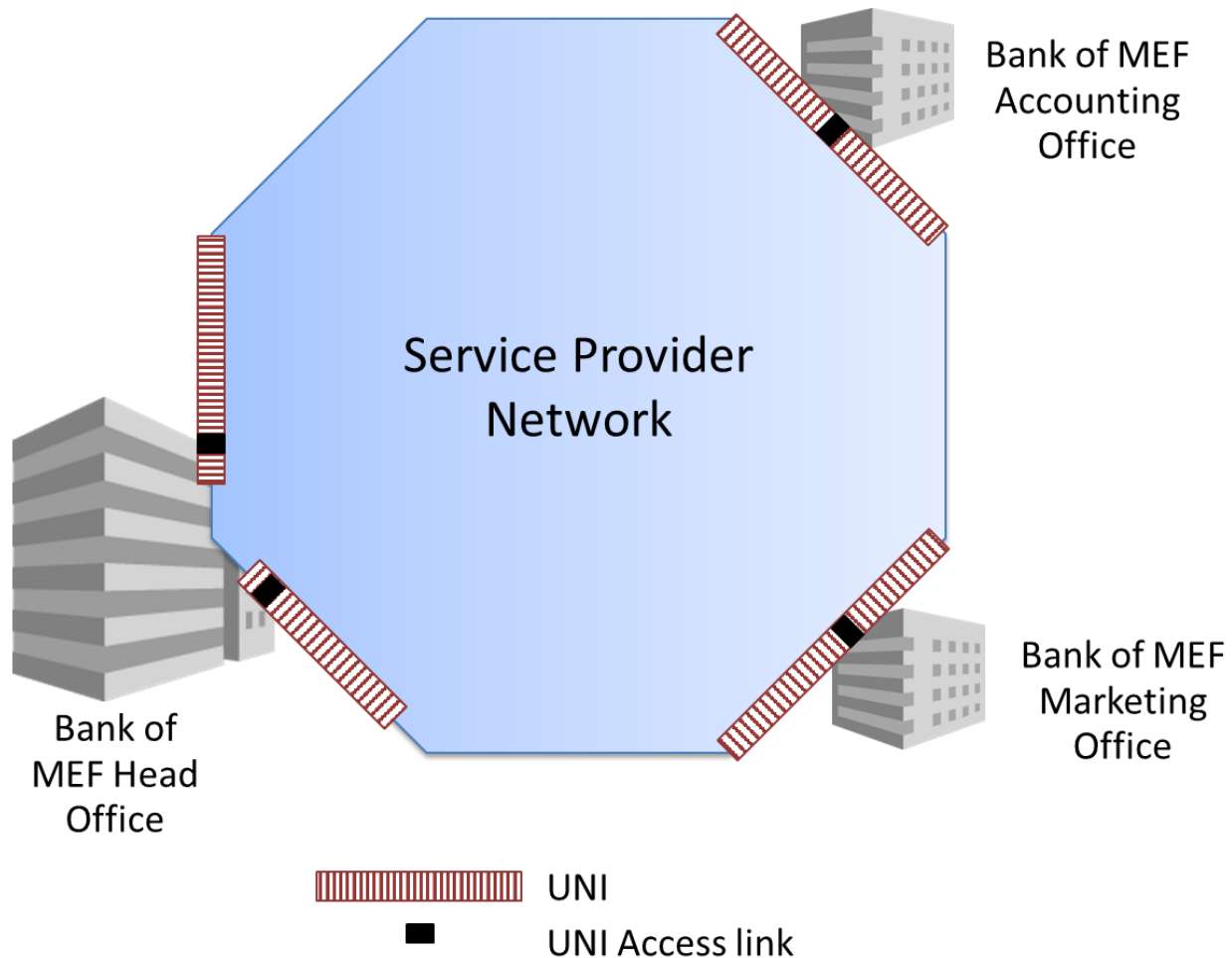
Figure 44 shows a Subscriber, Bank of MEF, who has three sites that they want to connect using a Subscriber IP Service. Bank of MEF has two departments, an accounting department and a



marketing department. At the head office, both departments are present, whereas at the other two sites, only one department is present.

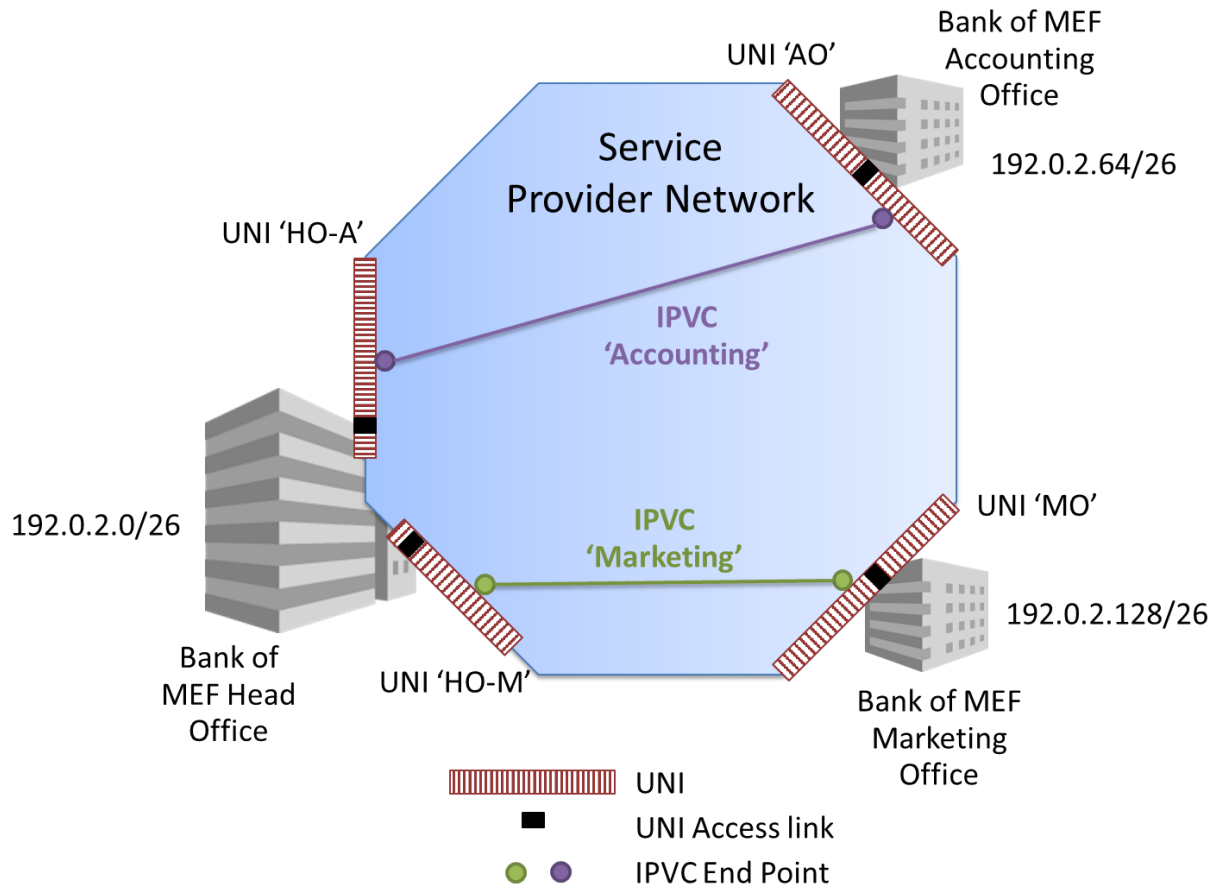
At the head office, Bank of MEF uses Ethernet VLANs to separate traffic for the two departments. Although all hosts use IP addresses in the same IP Prefix, the network is configured so as to assign each host to one or the other VLAN. Bank of MEF has a single physical link to the SP at the head office site, but extends their VLANs over this link, thus creating two separate IP UNIs.

At the other two sites, there are no VLANs and only a single IP UNI.



**Figure 44 – Example IP Service**

Bank of MEF connects their sites using two IPVCs, as shown in Figure 45.



**Figure 45 – Example IP Service showing IPVCs**

Both of the IPVCs use Standard IP Routing for packet delivery (section 10.4). With reference to the routing information databases described in section 9, in this example, a single IP Prefix is reachable via each UNI and contained in  $RID_{UNI}$ :

- UNI 'HO-A': 192.0.2.0/26
- UNI 'AO': 192.0.2.64/26
- UNI 'HO-M': 192.0.2.0/26
- UNI 'MO': 192.0.2.128/26

In this example, all of the IPVC EPs have the IPVC EP Prefix Matching Service Attribute (section 11.5) set to an empty list, so  $RID_L$  for each IPVC EP is the same as  $RID_{UNI}$  for the corresponding UNI.  $RT_{IPVCEP}$  in each case contains two routes: a route out of the local UNI from  $RID_L$ , and a route out of the other UNI that the IPVC is attached to, from  $RID_L$  for the other IPVC EP.

Packet delivery per the requirements in section 10.4 is therefore straightforward: when an Ingress IP Packet is received at a UNI, it is mapped to the only IPVC EP at that UNI, provided that the destination address is reachable. The packet is then delivered to the appropriate IPVC EP (most likely, the other IPVC EP for this IPVC).

Note that in this example, the VLAN with which a packet is received from the head office is used to determine which UNI it is received on. This happens at Layer 2 and hence is outside the scope of the IP Service, other than that the VLAN for each UNI needs to be specified (see section 13.3).

## B.5 Class of Service Examples

There are a number of Service Attributes relating to the handling of Classes of Service for IP Data Packets:

- IPVC List of CoS Names (section 10.8) – this is a simple list of CoS Names used in the IPVC.
- IPVC DSCP Preservation (section 10.7) – this determines whether the SP can modify the value in the DS field in IP Data Packets.
- UNI List of Control Protocols (section 12.6) – this determines which Ingress IP Packets at a UNI are considered to be IP Control Protocol Packets and which are considered to be IP Data Packets.
- IPVC EP Ingress Class of Service Map (section 11.9) – this describes how Ingress IP Packets are mapped to a particular CoS Name.
- IPVC EP Egress Class of Service Map (section 11.10) – this describes how the DS Field is set in Egress IP Packets.

The first subsection below shows some examples of the IPVC EP Ingress Class of Service Map (section 11.9). The subsequent subsections show two examples of the use of the above attributes in combination.

### B.5.1 Ingress CoS Map Examples

The IPVC EP Ingress Class of Service Map Service Attribute (section 11.9) provides a flexible way to map Ingress IP Data Packets to Class of Service Names (CoS Names). As a result of this flexibility, the structure and value of the attribute can be somewhat complex; however, in simple cases, the value of the attribute can also be straightforward. Several examples are given below, roughly in order of increasing complexity.

Note: This appendix refers to the IPVC EP Ingress Class of Service Map Service Attribute (section 11.9), however the same points can equally be applied to the Cloud Ingress Class of Service Map in the IPVC Cloud Service Attribute (section 10.13.2).

The IPVC EP Ingress Class of Service Map Service Attribute is a three-tuple consisting of a list of fields, *F*; a mapping from values of those fields to CoS Names, *M*; and a default CoS Name, *D*. It is important to note that the attribute applies only to Ingress IP Data Packets – that is, to IP Packets as they cross the UNI from the Subscriber to the SP – and that the map assigns a CoS Name to each such packet. This document does not specify whether or how the SP marks packets assigned a given CoS Name within the SP Network.

CoS Names should not be confused with the names assigned to particular values of the DS Field (that is, with DSCP names) or with named “per-hop behaviors” (PHBs), even though the same names are often used for all three purposes. To avoid such confusion in the following examples,

values of the DS Field are given numerically rather than using DSCP names, and CoS Names that mimic DSCP or PHB names are avoided.

The CoS Names used in the Ingress CoS Map are taken from the IPVC List of Class of Service Names Service Attribute (section 10.8).

The simplest example of an Ingress CoS Map is when the IPVC only has a single CoS Name, and all Ingress IP Data Packets are mapped to it. For example, suppose the IPVC List of CoS Names contains the single entry “Single”. In this case, the Ingress CoS Map can be set as follows (although note that the value of  $F$  in this case is arbitrary and has no effect):

- $F = [ IP\ DS ]$
- $M = [ ]$  (i.e., empty)
- $D = \text{“Single”}$

When an IPVC has more than one CoS Name, a non-empty mapping is needed. The most straightforward way to map packets to different CoS Names is to base this on only a single field. The following example uses the IP DS Field, and maps different values to one of two CoS Names, “High” and “Low”:

- $F = [ IP\ DS ]$
- $M = [ (46) \rightarrow \text{“High”} ]$
- $D = \text{“Low”}$

In this case, a single DSCP, 46, is mapped to CoS Name “High”, and all other values are mapped to the default CoS Name, “Low”. The example below shows a similar case, but this time there are multiple DSCPs mapped to “High”:

- $F = [ IP\ DS ]$
- $M = [ (10) \rightarrow \text{“High”}, (18) \rightarrow \text{“High”}, (48) \rightarrow \text{“High”} ]$
- $D = \text{“Low”}$

The next example uses the Source IP Address field to determine the CoS Name, rather than the IP DS Field. This could be used to ensure traffic originating on different subnets in the Subscriber Network is handled differently. In this case, the IPVC has three classes of service: “High”, “Normal” and “Data”:

- $F = [ Source\ IP\ Address ]$
- $M = [ (203.0.113.0/24) \rightarrow \text{“High”}, (2001:0DB8:0001::/56) \rightarrow \text{“High”}, (192.0.2.0/24) \rightarrow \text{“Data”}, (2001:0DB8:2002::/56) \rightarrow \text{“Data”} ]$
- $D = \text{“Normal”}$

In the above examples, the CoS Name can be determined by looking at a single field in the Ingress IP Data Packet. However, in some cases it is necessary to consider multiple fields. A common instance of this is to identify a particular protocol by matching on a TCP or UDP port number – this requires matching on the L4 Protocol along with the source or destination port. The following example illustrates how traffic for different protocols can be assigned different CoS Names. Note that  $F$  contains two fields L4 Protocol and Destination L4 Port, and each entry in  $M$  maps a pair

of (L4 Protocol, Destination L4 Port) values to a CoS Name. For illustration, the protocol corresponding to each (L4 Protocol, Destination L4 Port) pair is shown, but this is not part of the attribute value.

- $F = [ \text{L4 Protocol, Destination L4 Port} ]$
- $M = [ \begin{array}{ll} (6, 25) \rightarrow \text{“Bulk”}, & (\text{TCP/SMTP}) \\ (6, 22) \rightarrow \text{“Interactive”} & (\text{TCP/SSH}) \\ (6, 69) \rightarrow \text{“Bulk”} & (\text{TCP/TFTP}) \\ (6, 80) \rightarrow \text{“Interactive”} & (\text{TCP/HTTP}) \\ (17, 5060) \rightarrow \text{“Voice”} & (\text{UDP/SIP}) \\ (17, 5061) \rightarrow \text{“Voice”} & (\text{UDP/SIP}) \\ (6, 5222) \rightarrow \text{“Interactive”} & (\text{TCP/XMPP}) \end{array} ]$
- $D = \text{“Normal”}$

In this example, TCP packets destined for ports 25 or 69 are mapped to CoS Name “Bulk”, TCP packets destined for ports 22, 80 or 5222 are mapped to CoS Name “Interactive”, UDP packets destined for ports 5060 or 5061 are mapped to CoS Name “Voice”, and all other packets are mapped to CoS Name “Normal” – this includes IP Packets that do not contain a TCP or UDP datagram.

The final example below shows a case where three fields are considered to determine the CoS Name: the Source IP Address, L4 Protocol and Source L4 Port. Again, the protocol corresponding to each entry in  $M$  is shown for illustration, but this is not part of the attribute value.

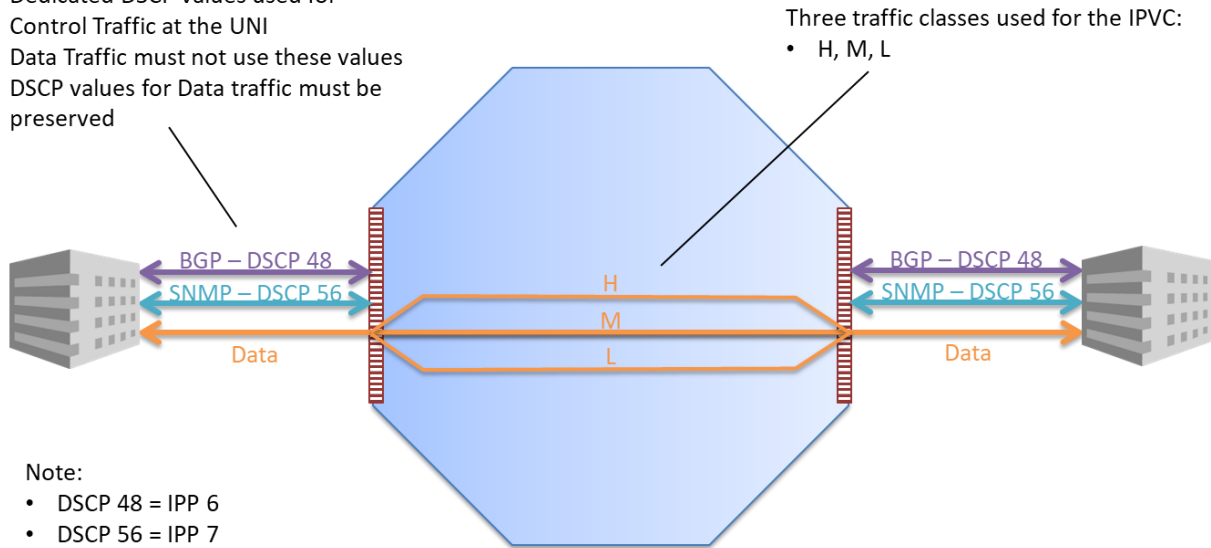
- $F = [ \text{Source IP Address, L4 Protocol, Source L4 Port} ]$
- $M = [ \begin{array}{ll} (203.0.113.0/24, 6, 80) \rightarrow \text{“Web”}, & (\text{TCP/HTTP}) \\ (203.0.113.128/26, 6, 80) \rightarrow \text{“Normal”} & (\text{TCP/HTTP}) \\ (203.0.113.0/24, 6, 443) \rightarrow \text{“Web”} & (\text{TCP/HTTPS}) \\ (203.0.113.0/24, 6, 8080) \rightarrow \text{“Web”} & (\text{TCP/HTTP Cache}) \\ (203.0.113.0/24, 17, 63) \rightarrow \text{“High”} & (\text{UDP/DNS}) \\ (192.0.2.0/24, 17, 63) \rightarrow \text{“High”} & (\text{UDP/DNS}) \end{array} ]$
- $D = \text{“Normal”}$

A notable aspect of this example is that there are multiple entries for TCP port 80, where one of the IP Prefixes specified for the Source IP Address is more specific than the other. In this case, the most specific entry is used, so traffic from TCP port 80 from hosts in 203.0.113.128/26 or hosts outside 203.0.113.0/24 is mapped to CoS Name “Normal”, while traffic from TCP port 80 from other hosts in 203.0.113.0/24 (i.e., hosts that are not in 203.0.113.128/26) is mapped to CoS Name “Web”.

### B.5.2 Class of Service Handling with DSCP Preservation

Figure 46 illustrates an example where the Subscriber wants to reserve some specific DSCP values for control protocols, and otherwise preserve the DSCP values in IP Data Packets. Ingress IP Data Packets with the reserved DSCP values are to be discarded. Three CoS Names are defined for the IPVC: ‘H’, ‘M’ and ‘L’:

- Dedicated DSCP values used for Control Traffic at the UNI
- Data Traffic must not use these values
- DSCP values for Data traffic must be preserved

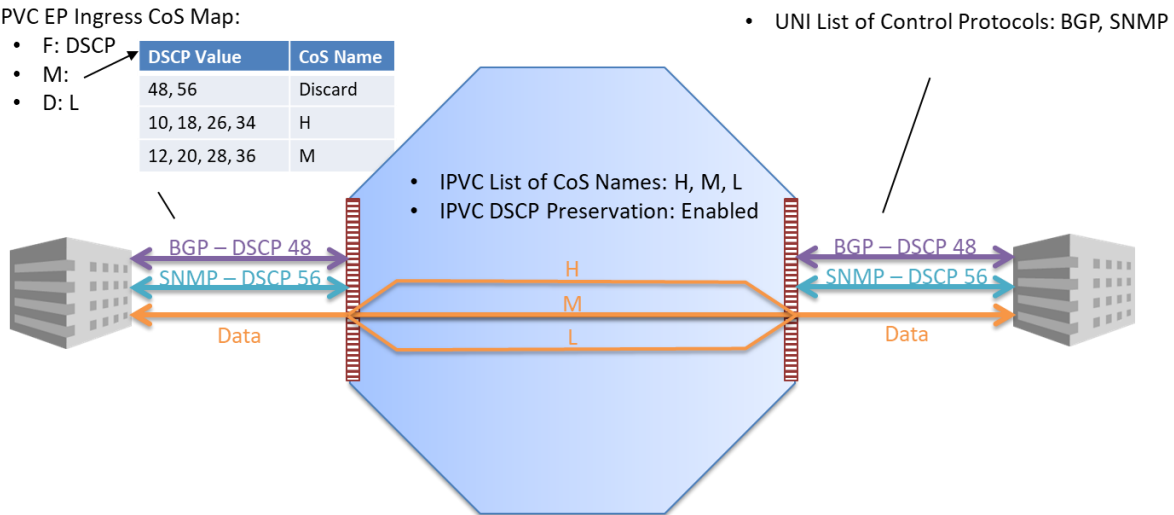


**Figure 46 – Example with DSCP Preservation**

The values for the Service Attributes that are agreed in order to implement the above are shown in Figure 47.

- UNI List of Control Protocols: BGP, SNMP
- IPVC EP Ingress CoS Map:
  - F: DSCP
  - M:
  - D: L

DSCP Value	CoS Name
48, 56	Discard
10, 18, 26, 34	H
12, 20, 28, 36	M



**Figure 47 – Example with DSCP Preservation showing Service Attributes**

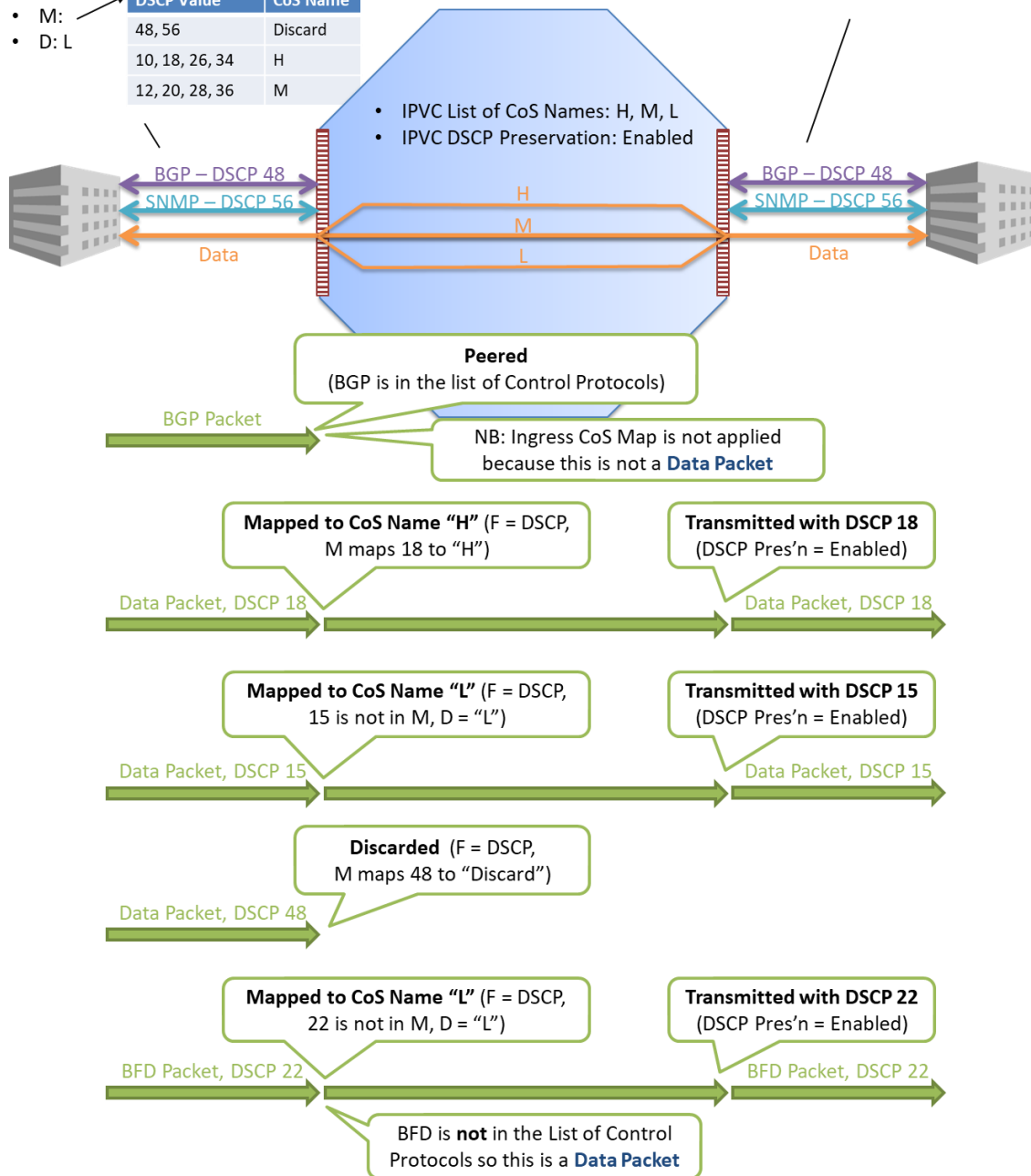
The IPVC List of CoS Names contains the three CoS Names used in the IPVC, and IPVC DSCP Preservation is set to *Enabled*. At each UNI, the UNI List of Control Protocols includes BGP and SNMP, with the addressing information set to *Any*. The IPVC EP Ingress Class of Service Map uses DSCP as the only field in the packet, and maps DSCP values to CoS Names as shown.

Using these attribute values, Figure 48 shows how various packets arriving at the UNI on the left are handled:

- UNI List of Control Protocols: BGP, SNMP
- IPVC EP Ingress CoS Map:
  - F: DSCP
  - M:
  - D: L

DSCP Value	CoS Name
48, 56	Discard
10, 18, 26, 34	H
12, 20, 28, 36	M

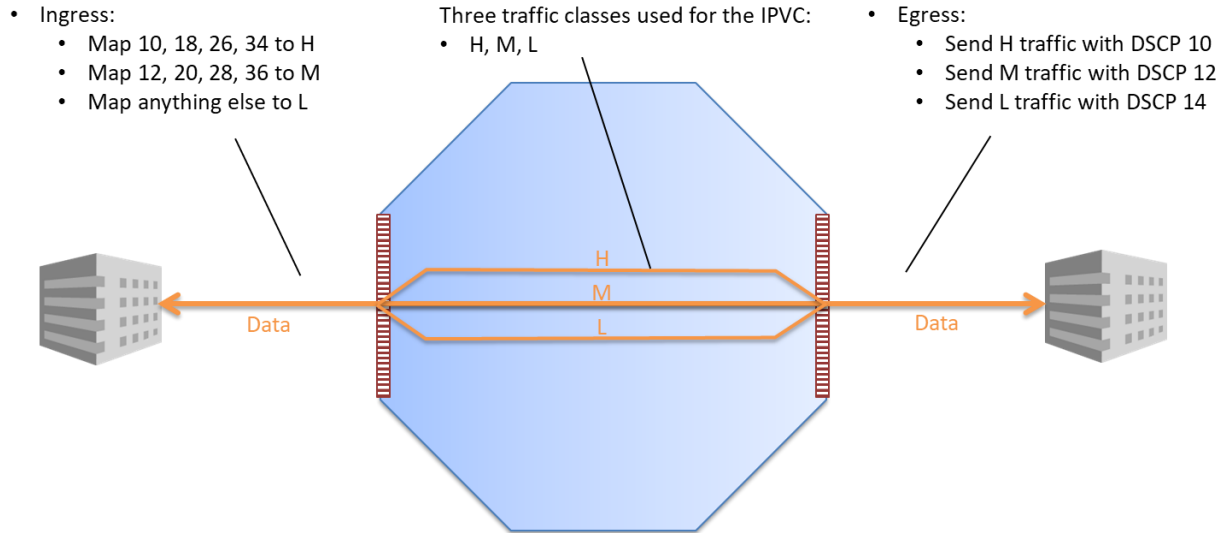
- UNI List of Control Protocols: BGP, SNMP



**Figure 48 – Example with DSCP Preservation showing packet handling**

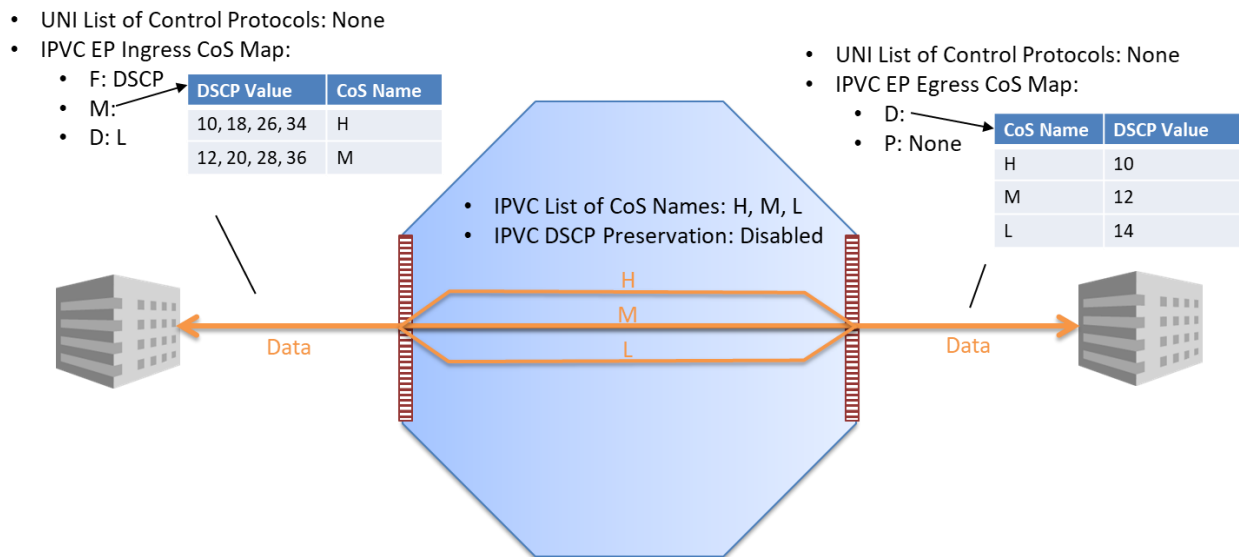
### B.5.3 Class of Service Handling with an Egress CoS Map

Figure 49 shows an example of a Subscriber who has an IPVC using three Classes of Service. The Subscriber uses DSCP in Ingress IP Packets to indicate the desired class of service to the SP. This example shows a case where the Subscriber also wants specific DSCP values to be set in Egress IP Packets, which requires an Egress Class of Service Map.



**Figure 49 – Example of an Egress CoS Map**

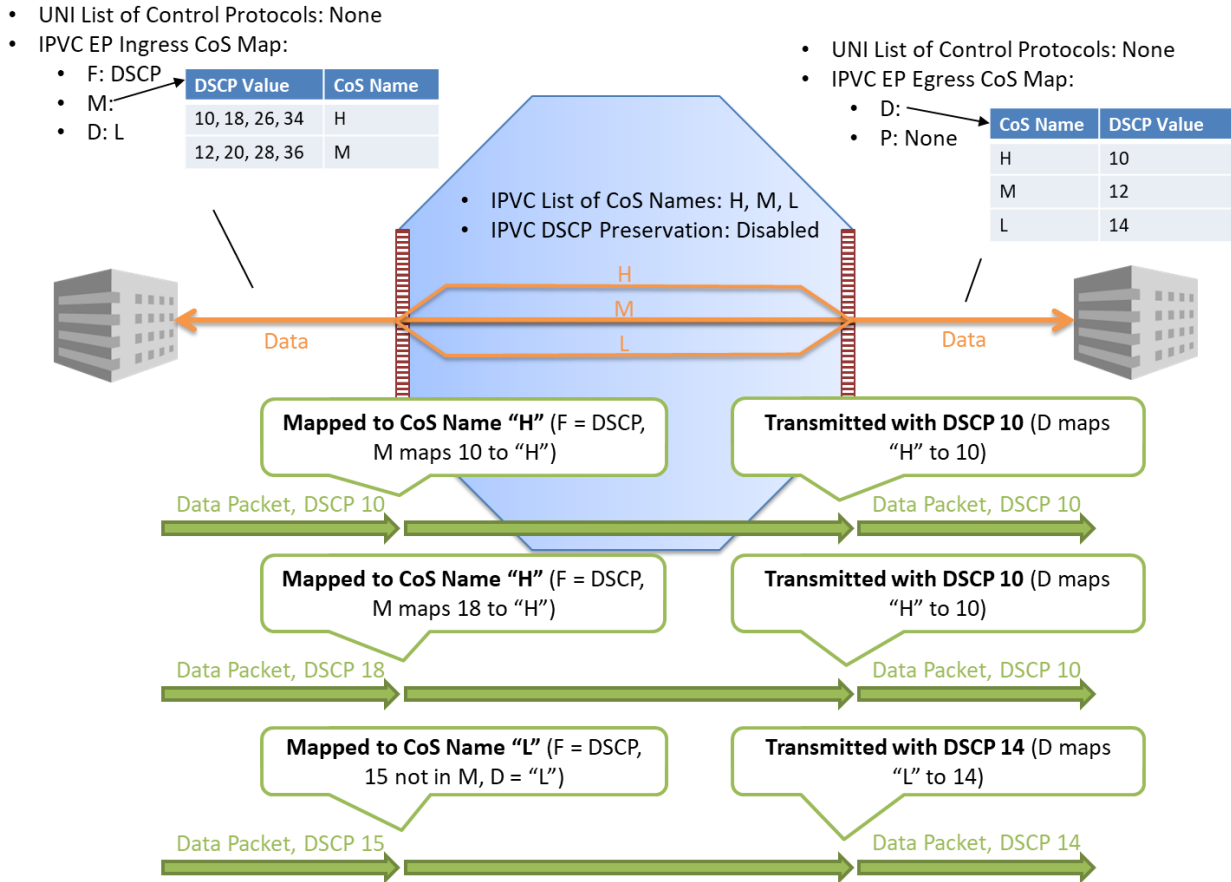
The attribute values used to implement the above are shown in Figure 50. The IPVC List of CoS Names includes the three CoS Names, ‘H’, ‘M’ and ‘L’, and IPVC DSCP preservation is *Disabled*. In this example, there are no IP Control Protocols defined. In the Ingress CoS Map, only the DS field is used in Ingress IP Data Packets to determine the CoS Name, and some specific values map to CoS Names ‘H’ and ‘M’; all other values map to ‘L’. For Egress IP Data Packets, an Egress CoS Map is shown that maps each of the CoS Names to a DSCP value that will be set in corresponding egress packets.



**Figure 50 – Example of an Egress CoS Map showing Service Attributes**

The effect of the above attributes on various IP Data Packets is shown in Figure 51.

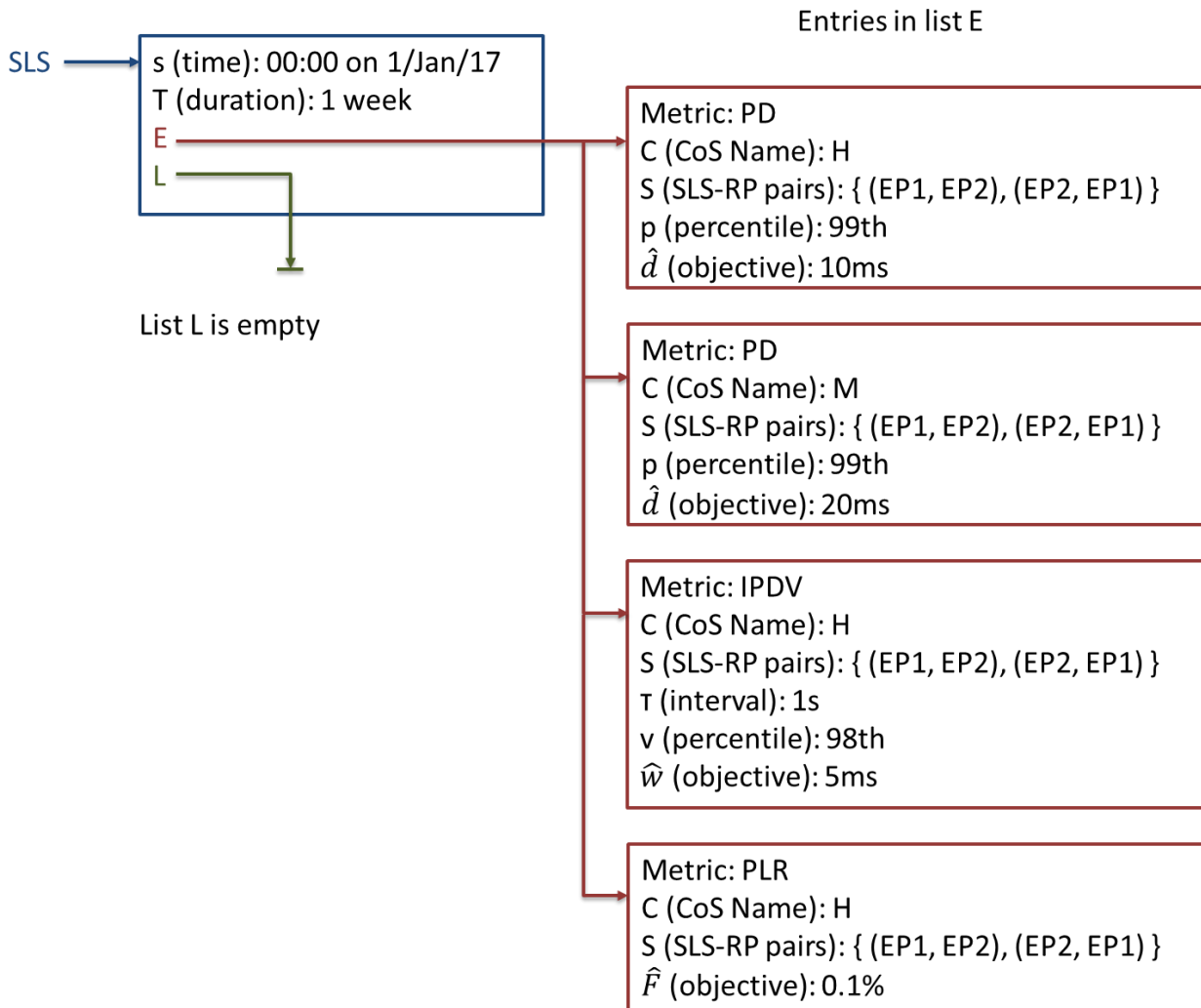




**Figure 51 – Example of an Egress CoS Map showing packet handling**

## B.6 SLS Examples

The structure of the IPVC Service Level Specification Service Attribute, and the use of SLS-RPs, are illustrated by the following examples. Figure 52 shows an example of the SLS for a Subscriber IPVC with two IPVC EPs, “EP1” and “EP2”. The SLS is specified using the IPVC EPs directly as the SLS-RPs, hence the set of locations, *L*, is empty. The set of SLS entries, *E*, contains entries for two CoS Names, “H” and “M”. For CoS Name “H”, there are objectives for One-way Packet Delay Percentile (PD), One-way Inter-Packet Delay Variation (IPDV) and One-way Packet Loss Ratio (PLR). For CoS Name “M”, there is only an objective for PD. All of the objectives are specified as applying to both directions – that is, from EP1 to EP2 and from EP2 to EP1.



**Figure 52 – Example SLS using IPVC EPs**

Figure 53 shows a different example, of the SLS for a cloud access IPVC with IPVC EPs at three UNIs. In this case, the SLS is specified using locations: three locations are defined in set *L*: “LON”, “AMS” and “SFO”. Two UNIs (“UNI1” and “UNI2”) are in London and the corresponding IPVC EPs are associated with location “LON”, and one UNI is in San Francisco and the corresponding IPVC EP is associated with location “SFO”. In addition, the SP connects to the cloud service at two locations, “AMS” and “SFO”. Note that there are no UNIs associated with the “AMS” location.

There are three entries in set *E*, all for CoS Name “Best Effort”. Two entries are for One-way Packet Delay Percentile (PD): one applies between London and Amsterdam, and the other between London and San Francisco. They have different objectives, perhaps reflecting the different geographical distances involved. The third objective is for One-way Packet Loss Ratio, and applies both between London and Amsterdam and between London and San Francisco. In this example, the SP and the Subscriber have not agreed to any performance objectives for traffic between San Francisco and Amsterdam, perhaps because they do not expect any traffic to flow between these locations.

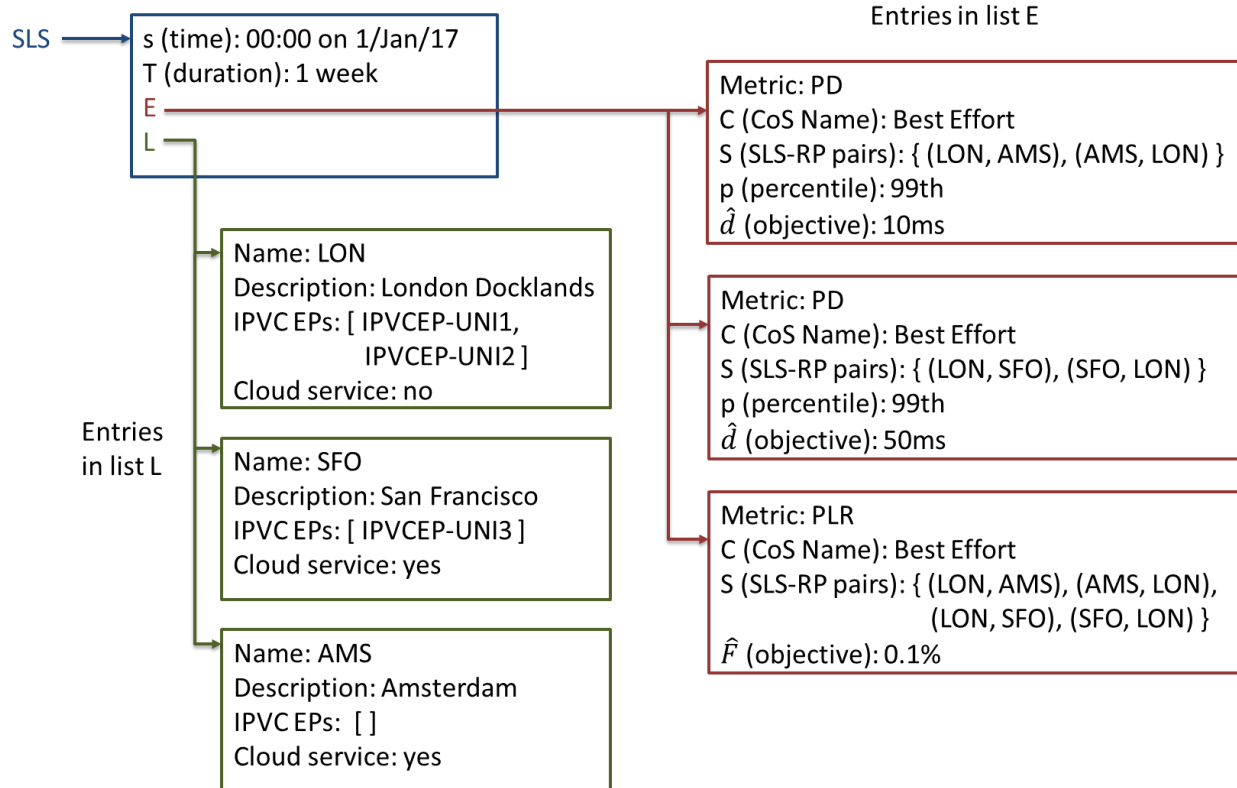


Figure 53 – Example SLS using Locations

Further examples of the SLS can be found in Appendix C.

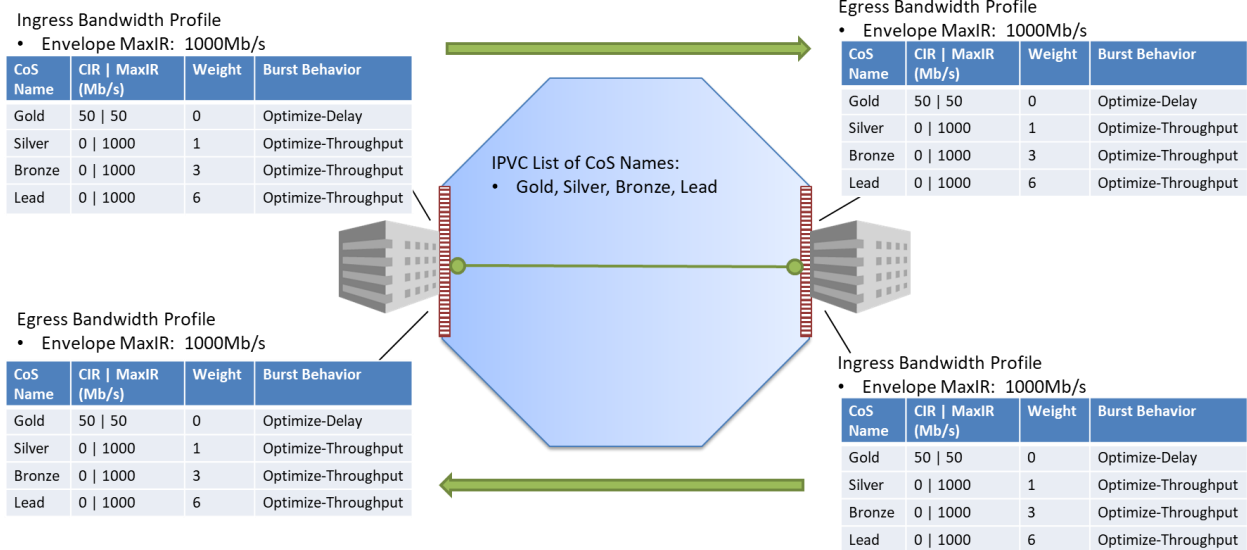
## B.7 Bandwidth Profile and Traffic Shaping Examples

The subsections below describe some use cases for Bandwidth Profiles for Subscriber IP Services, and suggest some possible ways to implement a shaping function.

### B.7.1 Bandwidth Profile Use Cases

Two use cases are described here: the first showing the use of symmetric ingress and egress Bandwidth Profiles for a Subscriber IP VPN service, and the second showing an ingress Bandwidth Profile for an Internet access service.

In the first use case, there is a single IPVC with an IPVC EP at each UNI. The IPVC has four classes of service (‘Gold’, ‘Silver’, ‘Bronze’ and ‘Lead’), and a Bandwidth Profile Flow is defined for each CoS Name. In this example, most of the Subscriber’s traffic is best-effort and is mapped to Lead, and there is only a small amount mapped to Silver. The Bandwidth Profile has a priority class for ‘Gold’ (with the Burst Behavior set to *Optimize-Delay*) and hints at shaping for the other CoS Names (with the Burst Behavior set to *Optimize-Throughput*), as shown in Figure 54.



**Figure 54 – Bandwidth Profile Example for an IP VPN Service**

The effect of this configuration is that traffic in the Gold class can use up to 50Mb/s, and is guaranteed this amount; traffic in the Silver class is guaranteed 10% [i.e. 1/(1 + 3 + 6)] of the remaining available bandwidth; Bronze class is guaranteed 30% [i.e. 3/(1 + 3 + 6)] of the remaining available bandwidth; and Lead class is guaranteed 60% [i.e. 6/(1 + 3 + 6)] of the remaining available bandwidth.

For each of Silver, Bronze and Lead, when there is no contention between traffic for that class and traffic from other classes, traffic for that class can use up to the full available bandwidth (i.e. up to 1000Mb/s).

If there is contention, then traffic is distributed according to the weights; for example, if traffic is received for classes Silver and Bronze, then Silver would get 25% of the available bandwidth (250Mb/s) and Bronze would get 75% (750Mb/s), i.e. in ratio 1:3. Similarly, if traffic is received for classes Bronze and Lead, then Bronze would get 33% and Lead would get 67%, i.e. in ratio 3:6, or equivalently 1:2.

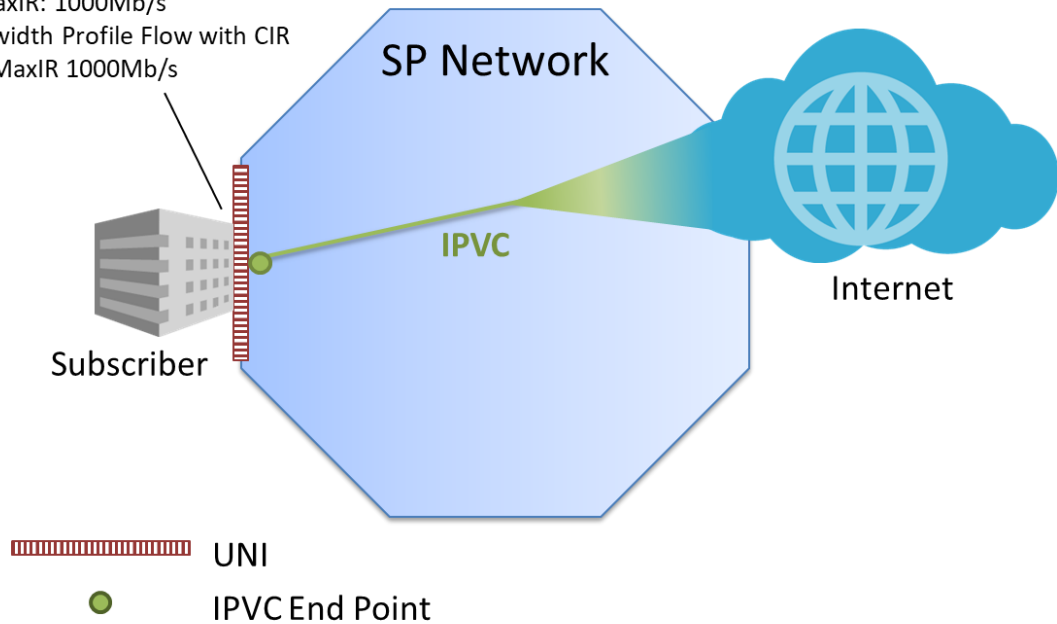
These Bandwidth Profiles could be implemented using symmetrical traffic shapers, with a priority queue for ‘Gold’ and weighted queues for the other classes. Such traffic shaping can be useful to the SP if the UNI is implemented over a bandwidth-constrained access network. By applying traffic shaping profiles, bursts of traffic are ‘smoothed out’, thus reducing the probability that packets are dropped as they traverse the access network. Without shaping, a burst of traffic might exceed the maximum capacity of the access network, leading to packet loss (which might cause the SP to fail to meet a packet loss objective in the SLS).

Note that in this example, the ingress and egress Bandwidth Profiles are symmetrical. In a multipoint service with three or more IPVC EPs, higher classes of service might need an increased weight in the egress Bandwidth Profile to accommodate ingress traffic from multiple sources.

The second use case shows an Internet access service, with a single class of service. An Ingress Bandwidth Profile is used, with a single Bandwidth Profile Flow for the whole UNI.

Ingress Bandwidth Profile

- Envelope MaxIR: 1000Mb/s
- Single Bandwidth Profile Flow with CIR 1000Mb/s, MaxIR 1000Mb/s

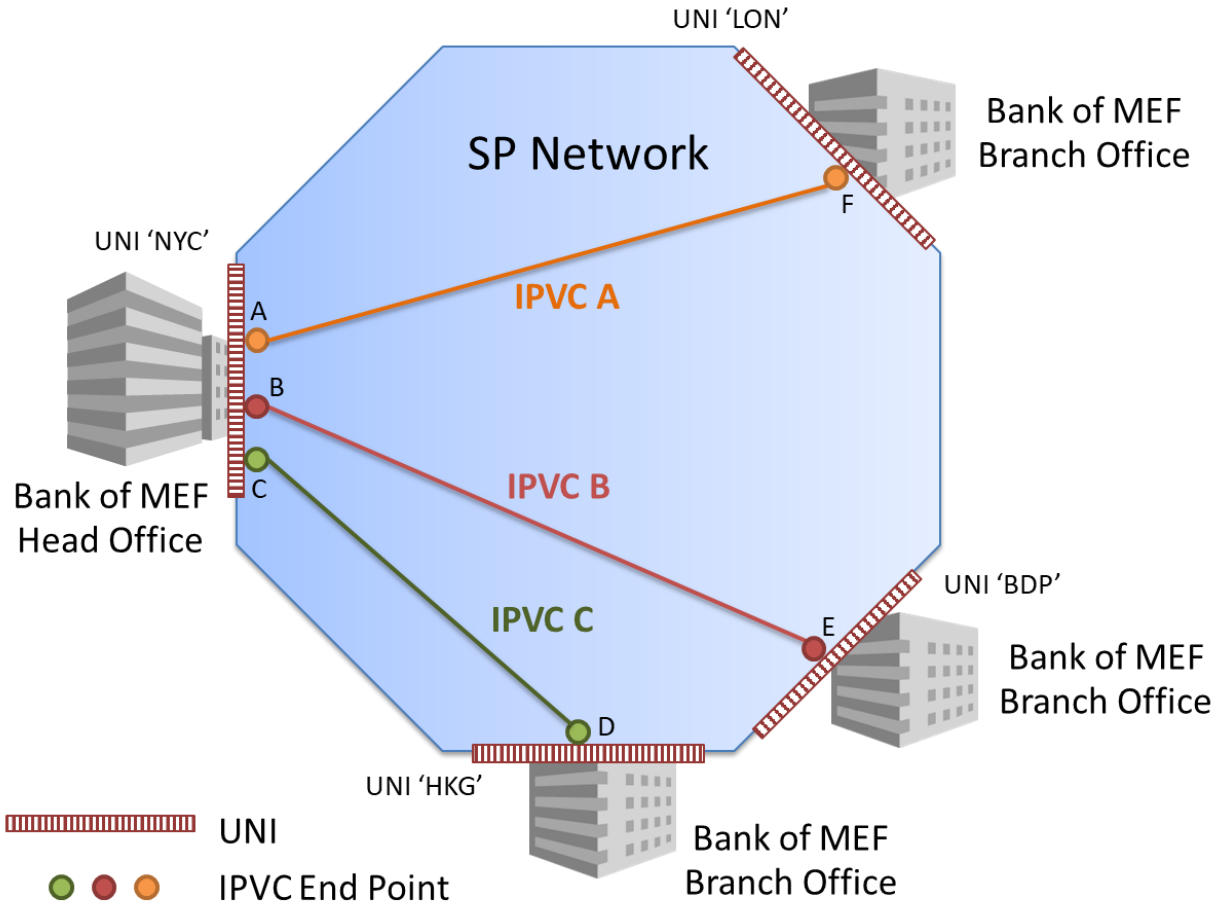


**Figure 55 – Bandwidth Profile Example for an Internet Access Service**

As there is only a single Bandwidth Profile Flow here, the effect of the any shaping is only to provide the “smoothing” behavior. This can provide a more consistent service experience for the Subscriber, and improves end-to-end TCP behavior.

**B.7.2 Bandwidth Profile with Multiple IPVC EPs**

When there are multiple IPVC EPs at a UNI, it is often desirable to use an ingress Bandwidth Profile at the UNI that has one BWP Flow per CoS Name. This cannot be specified directly, as CoS Names are specific to an IPVC EP. However, if all of the IPVCs use the same CoS Names, BWP Flows can be defined that match each CoS Name across all the IPVC EPs. This is illustrated by the example below, with reference to Figure 56.



**Figure 56 – Bandwidth Profile Example with Multiple IPVC EPs**

In this example, Bank of MEF has agreed on three IPVCs to connect their head office to three branches. All three IPVCs have the same value for the IPVC List of CoS Names Service Attribute (section 10.8), listing three CoS Names: High, Medium and Low.

At UNI 'NYC', a UNI Ingress Bandwidth Profile Envelope Service Attribute (section 12.4) is agreed, containing BWP Flows that match on a set of (IPVC EP, CoS Name) pairs (see Table 28). The value of the attribute is shown below:

- MaxIR<sub>E</sub>: 1000Mb/s
- T<sub>E</sub>: 5 ms
- BWP Flows: As shown in Table 43.

Flow ID	Flow Definition	CIR (Mb/s)	MaxIR (Mb/s)	Weight	Burst Behavior
1	{(A, High), (B, High), (C, High)}	50	100	1	<i>Optimize-Delay</i>
2	{(A, Medium), (B, Medium), (C, Medium)}	200	1000	3	<i>Optimize-Throughput</i>
3	{(A, Low), (B, Low), (C, Low)}	0	1000	6	<i>Optimize-Throughput</i>

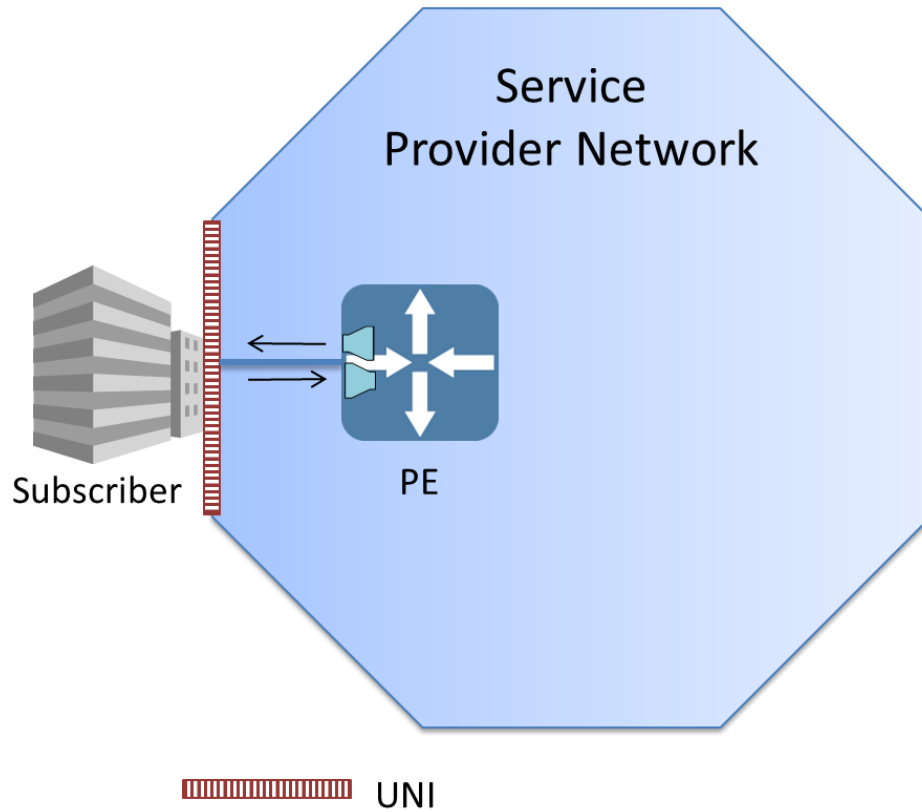
**Table 43 – Example BWP Flow Parameters for Multiple IPVC EPs**

The Flow Definitions above have the effect of creating a BWP Flow for each of the three CoS Names, that matches all IP Packets mapped to that CoS Name, regardless of which IPVC EP they are mapped to.

### B.7.3 Bandwidth Profile Implementation

This specification does not constrain how, or even whether, traffic metering, policing and shaping are implemented by an SP. However, this section shows some possible locations that such functions could be implemented at a UNI. This is not an exhaustive list. Such functions are referred to collectively in this appendix as traffic conditioning functions.

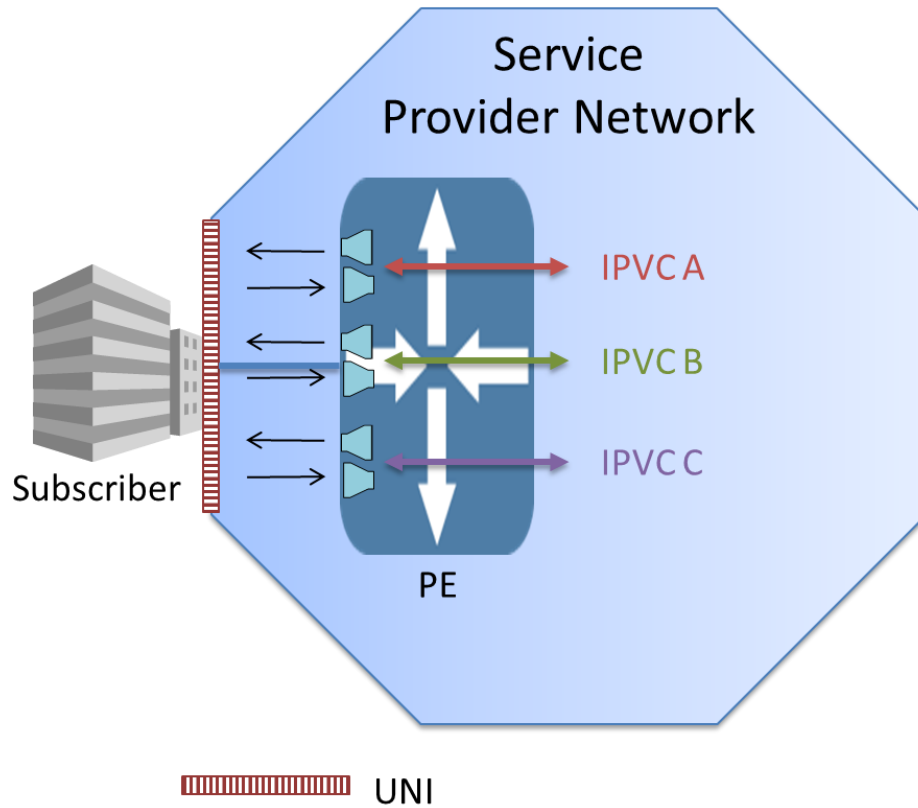
Figure 57 shows a case where there is a Subscriber-Managed CE, and a single IPVC EP at the UNI. The SP implements ingress and egress traffic conditioning functions for the whole UNI, on the PE.



**Figure 57 – Example Traffic Conditioning Location for a Single IPVC**

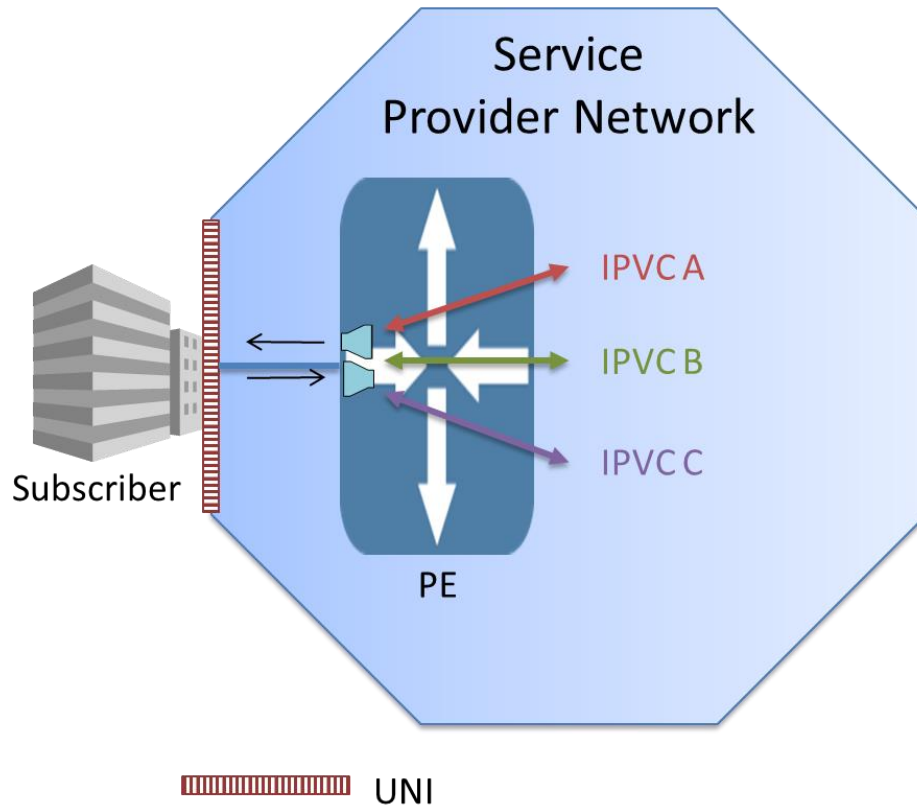
Figure 58 again shows a case of a Subscriber-Managed CE, but with three IPVC EPs. In this case, a separate BWP Envelope has been agreed for ingress and egress for each IPVC, and the SP implements this with corresponding traffic conditioning functions.





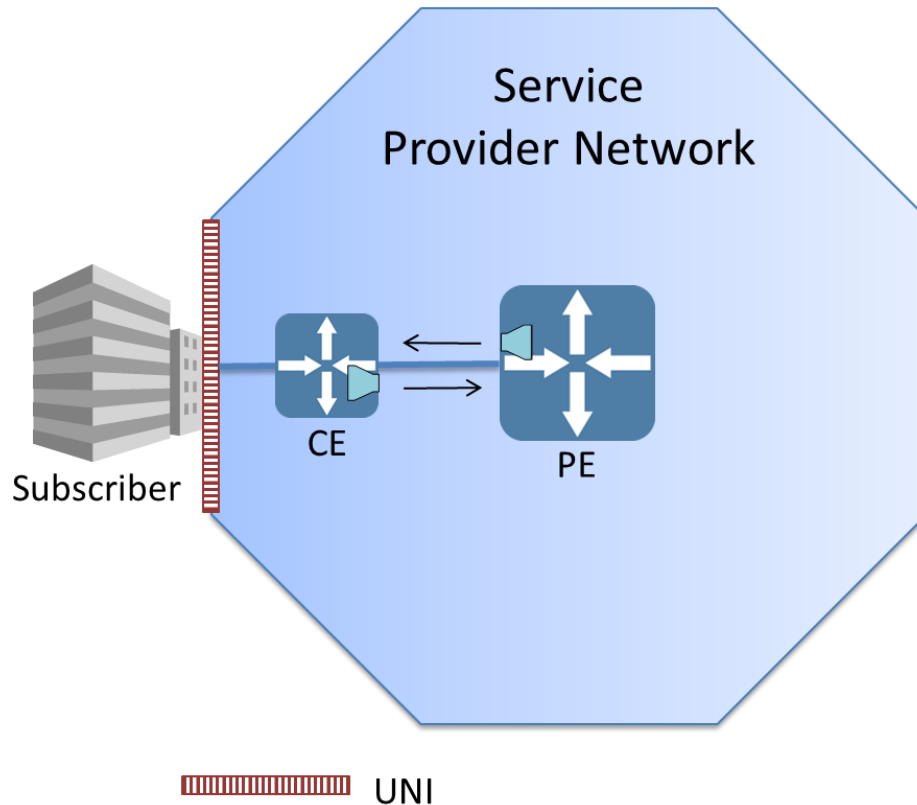
**Figure 58 – Example per-IPVC Traffic Conditioning Location for Multiple IPVCs**

Figure 59 is a similar scenario, but in this case there is a single BWP Envelope for ingress and egress, containing flows for all of the IPVCs. Again, the SP could use corresponding traffic conditioning functions.



**Figure 59 – Example per-UNI Traffic Conditioning Location for Multiple IPVCs**

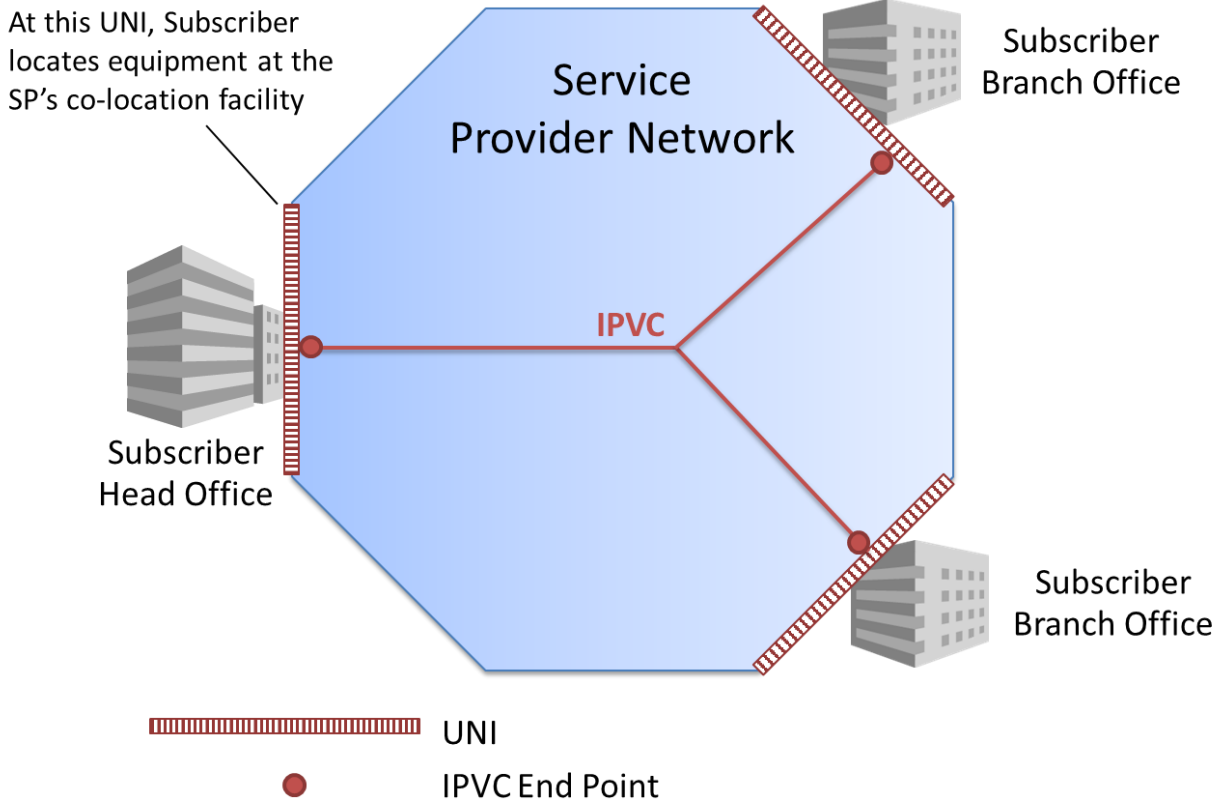
Figure 60 shows a case where there is a Provider-Managed CE. In this case, the SP implements ingress traffic conditioning on the CE, and egress traffic conditioning on the PE.



**Figure 60 – Example Traffic Conditioning Location for a Provider-Managed CE**

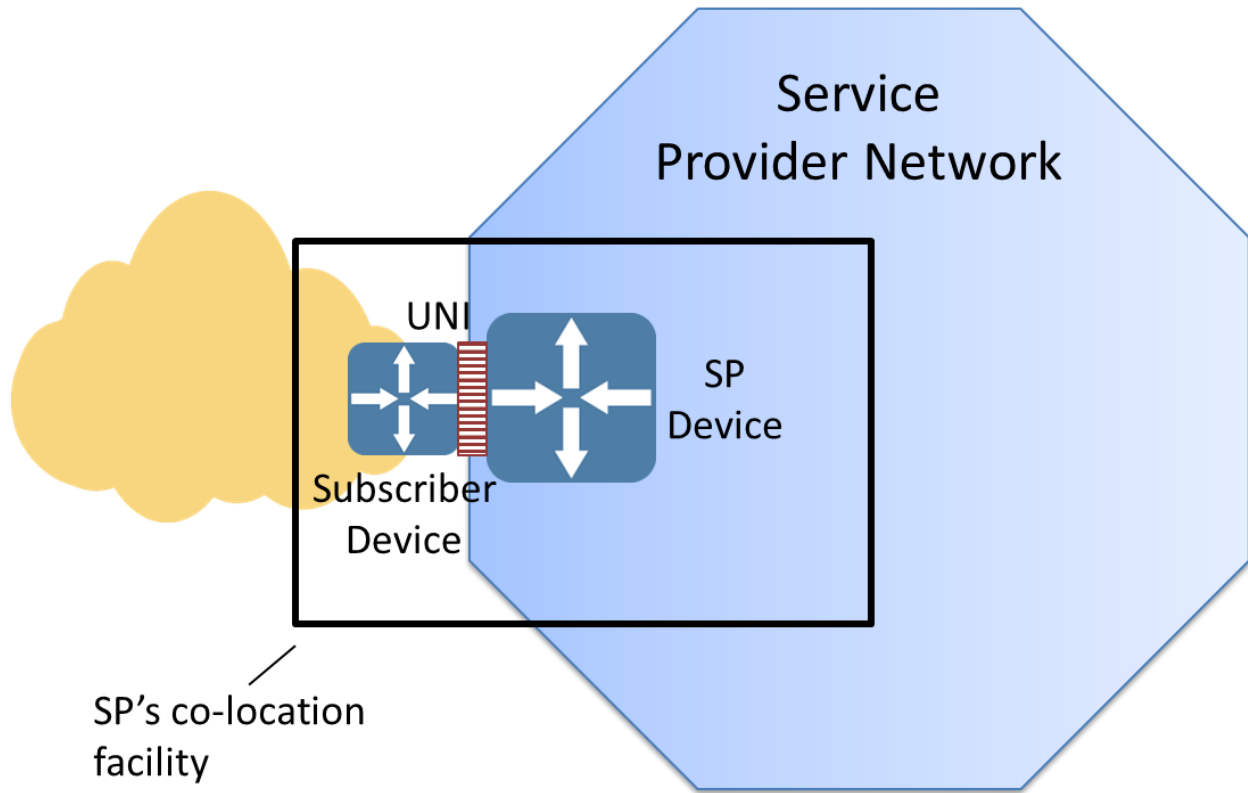
### B.8 Subscriber Provided Access

In some cases, Subscribers have communications networks of their own and provide connections between their locations and the Service Provider Network. An example of this might be a company in the financial industry that has installed their own network facilities such as fiber or radio, between their locations in a metropolitan area. This network is owned and operated by the Subscriber. The Subscriber desires a connection from this network to the Service Provider for IP Services. Instead of ordering an SP provided access connection, the Subscriber can instead connect with the SP via a co-location between their network and the SP Network. An example of this is shown in Figure 61.



**Figure 61 – Example of Subscriber Provided Access**

As shown in Figure 61, the Subscriber connects to the SP at an SP operated and maintained location. Within the SP co-location facility, the Subscriber places their equipment and a UNI connects the Subscriber Network to the Service Provider Network. This is shown in Figure 62.



**Figure 62 – SP Co-location Facility**

The connection shown in Figure 62 represents a UNI similar to the other UNIs shown in this specification. It can contain one or more UNI Access Links and have multiple IPVC EPs. The only difference in this configuration is that the Subscriber maintains the connections, within their network, from the SP's location to one or more Subscriber locations versus the SP providing these connections.

## Appendix C Implementation Examples for Subscriber IP Services (Informative)

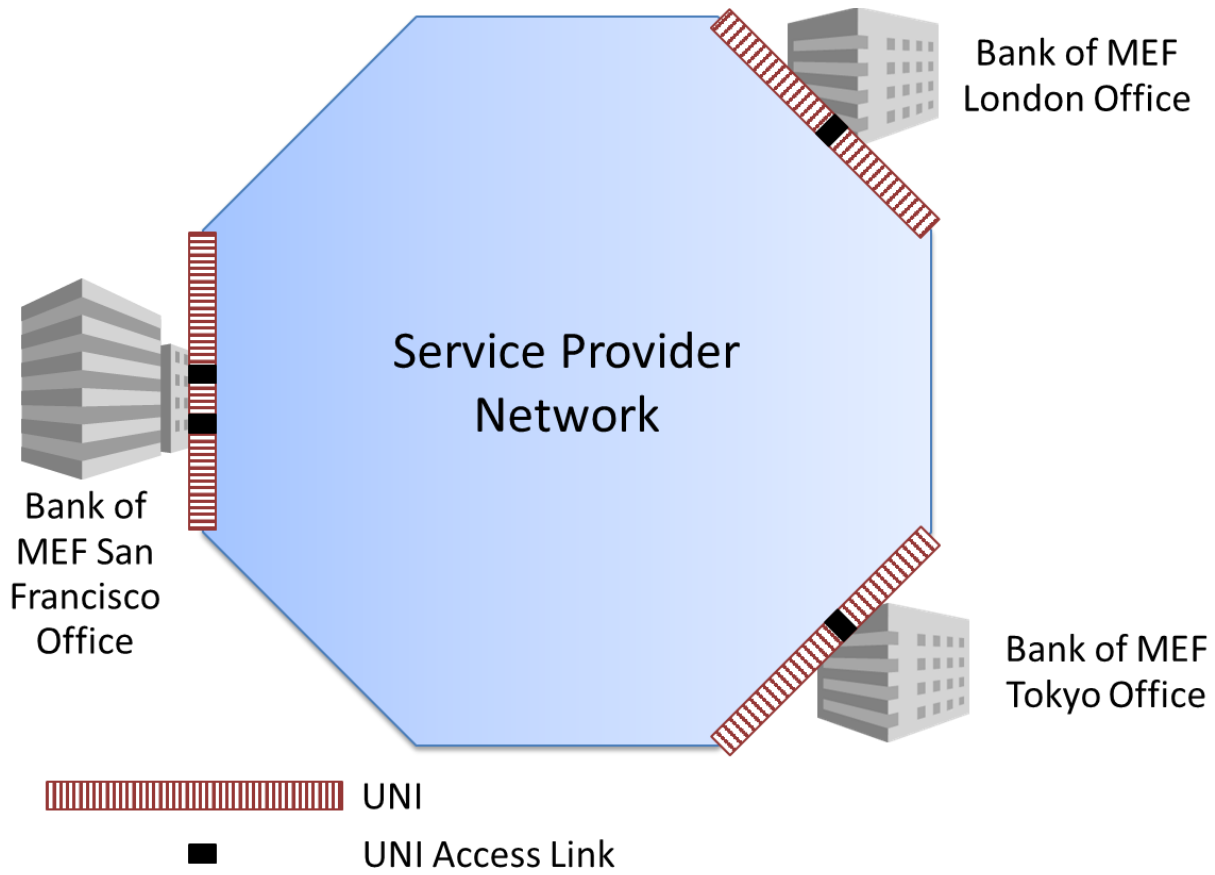
This appendix provides some informative examples showing values for all of the IP Service Attributes applicable to a Subscriber IP Service, and indicating how they are typically implemented. Note that this specification does not constrain the implementation of IP Services; however, certain implementation approaches are sufficiently common that it is useful to describe how they relate to the Service Attributes described in this document. The examples shown are illustrative and are not intended to indicate particular best practice, or to show how Service Attributes might best be presented.

Note that these examples use IPv4 Documentation Space per RFC 5737 [42], IPv6 Documentation Space per RFC 3849 [27], and Documentation AS Numbers per RFC 5398 [38].

In the following subsections, values that are lists are shown as enclosed in square brackets [], with list entries separated by commas. An empty list is shown as “[ ]”. Values that are sets are shown as enclosed in braces {}, with entries separated by commas. An empty set is shown as “{ }”. Values that are tuples, i.e. that consist of several parameters, are enclosed in parentheses (), with parameter name/value pairs separated by commas.

### C.1 Multipoint Subscriber IPVC Example

In this example, the Bank of MEF has three locations that it would like to connect with an IP VPN Service. As they would like all sites to have reachability to each other, they request a Multipoint IPVC.



**Figure 63 – Example Multipoint IP VPN**

The tables below show the values of all of the Service Attributes. The Identifiers in this example are all arbitrarily chosen; in practice, Service Providers typically have a standard in place to ensure uniqueness. The Multipoint IPVC in this example uses standard IP routing with no per site filters or prefix mapping. The Subscriber has been assigned a /24 and a /25 IPv4 Prefix in a manner which is outside of the scope of this example. Documentation space is used here, but these could be private addresses, public addresses owned by the Subscriber, public addresses owned by the Service Provider and assigned to the Subscriber, or a combination of these. The IP Prefixes would only need to be listed in the Service Attributes if the Subscriber requests them from the Service Provider, or if the Subscriber needs the Service Provider to act on them in some way (such as per site address filtering). The Service Provider and Subscriber agree on allowing a total of 400 IPv4 routes to be learned by the IPVC, which can be used for any prefix length, and this service is not using IPv6 routing.

In this example, the Service Provider and Subscriber agree on the following Classes of Service:

- The IPVC has four classes of service ('Gold', 'Silver', 'Bronze' and 'Lead').
- The value of the IPVC EP Ingress Class of Service Map Service Attribute is chosen to be the same at all of the IPVC EPs in the IPVC.

This is intended to make it simple to add further IPVCs, with additional IPVC EPs at the same UNI. Any further IPVCs would have the same four Classes of Service, and the same IPVC EP Ingress Class of Service Map at their end points.

The following design is agreed for Bandwidth Profiles, again accounting for the potential to add additional IPVC EPs at the UNI:

- To ensure deterministic behavior, each IPVC EP at a given UNI should have its own guaranteed and non-burstable bandwidth for the ‘Gold’ class of traffic.
- The UNI Ingress Bandwidth Profile Envelope Service Attribute is used, in order to allow sharing the bandwidth for classes ‘Silver’, ‘Bronze’ and ‘Lead’ among all of the IPVC EPs at the UNI.
- Each of ‘Silver’, ‘Bronze’ and ‘Lead’ classes has CIR = 200Mb/s, MaxIR = 1000Mb/s, weight as 6, 3 and 1 respectively.

The IP MTU for this IPVC has been identified by the Service Provider as 1500 Bytes, which for simplicity is identical throughout this example.

Table 44 shows the values of the Subscriber IPVC Service Attributes for the IPVC.

Service Attribute Name	Service Attribute Value
IPVC Identifier	IPVC.000001
IPVC Topology	Multipoint
IPVC End Point List	[ IPVCEP.LONDON.01.01, IPVCEP.SANFRANCISCO.01.01, IPVCEP.TOKYO.01.01 ]
IPVC Packet Delivery	Standard Routing
IPVC Maximum Number of IPv4 Routes	400
IPVC Maximum Number of IPv6 Routes	0
IPVC DSCP Preservation	Enabled
IPVC List of Class of Service Names	[ Gold, Silver, Bronze, Lead ]
IPVC Service Level Specification	( s: 00:00:00 on 1 July 2017, T: 1 Calendar Month, E: { ( Metric: One-way Packet Loss Ratio, C: Gold, S: {(IPVCEP.TOKYO.01.01, London), (London, IPVCEP.TOKYO.01.01)}, F̂: 0.1% ) }, L: { ( Name: London, Description: London Docklands IPVC EPs: [ IPVCEP.LONDON.01.01 ] ) } )
IPVC MTU	1500
IPVC Path MTU Discovery	Enabled
IPVC Fragmentation	Enabled



Service Attribute Name	Service Attribute Value
IPVC Cloud	None
IPVC Reserved Prefixes	[ 203.0.113.0/27 ]

**Table 44 – Example of Subscriber IPVC Service Attributes for a Multipoint IP VPN**

The Service Level Specification shows that the Service Provider and Subscriber agreed that for the ‘Gold’ class, there must be less than 0.1% One-way Packet Loss Ratio between the Tokyo IPVC EP and the “London” location in both directions. How this is measured is outside the scope of this document. The value of L identifies all the UNIs associated with the location “London”, in this case only “UNI.LONDON.01”. This is a necessary component as the location “London” is somewhere within the SP Network, not at the actual UNI. Field E can be expanded to include additional SLS metrics or additional Classes of Service, and field L can be expanded to include additional Location to UNI associations, should that be required.

The next three tables show the Service Attributes at the London office. Table 45 shows the values of the UNI Service Attributes for the London UNI.

Service Attribute Name	Service Attribute Value
UNI Identifier	UNI.LONDON.01
UNI Management Type	Subscriber-Managed
UNI List of UNI Access Links	[ UNIAL.LONDON.01.01 ]

Service Attribute Name	Service Attribute Value
UNI Ingress Bandwidth Profile Envelope	( MaxIR <sub>E</sub> : 1000Mb/s, T <sub>E</sub> : 2 ms, Flows: [ ( Flow Identifier: 1, Flow Definition: { ( IPVCEP.LONDON.01.01, Gold ) }, CIR: 50, MaxIR: 50, Weight: 1, Burst Behavior: Optimize-Delay ), ( Flow Identifier: 2, Flow Definition: { ( IPVCEP.LONDON.01.01, Silver ) }, CIR: 200, MaxIR: 1000, Weight: 6, Burst Behavior: Optimize-Throughput ), ( Flow Identifier: 3, Flow Definition: { ( IPVCEP.LONDON.01.01, Bronze ) }, CIR: 200, MaxIR: 1000, Weight: 3, Burst Behavior: Optimize-Throughput ), ( Flow Identifier: 4, Flow Definition: { ( IPVCEP.LONDON.01.01, Lead ) }, CIR: 200, MaxIR: 1000, Weight: 1, Burst Behavior: Optimize-Throughput ) ] )
UNI Egress Bandwidth Profile Envelope	None
UNI List of Control Protocols	[ ( Protocol: ICMP, Addressing: SP Addresses, Reference: RFC 792 ), ( Protocol: OSPF, Addressing: Any Reference: RFC 2328 ) ]

Service Attribute Name	Service Attribute Value
UNI Routing Protocols	[ ( Protocol: OSPF, Address Family: IPv4, Area ID: 100.100.100.1, Area Type: Normal, Authentication Type: Message Digest, Hello Interval: 10, Dead Interval: 40, Retransmit Interval: 5, Administrative Distance: 50 ) ]
UNI Reverse Path Forwarding	Enabled

**Table 45 – Example of UNI Service Attributes for the London UNI**

In this example, the Bank of MEF London location has a Subscriber managed router on site and they intend to peer OSPF with the Service Provider. OSPF, therefore, shows up in the UNI List of Control Protocols, as does any other protocol that the Subscriber and the Service Provider agree upon, such as ICMP to test local connectivity via ping. As ICMP is listed as a Control Protocol for SP Addresses, any ICMP packet not destined within the Service Provider’s network must be treated as an IP Data Packet. Additionally, parameters for OSPF have been documented.

Note that the above UNI Ingress BWP Envelope is defined such that each BWP Flow contains all Ingress IP Data Packets at the UNI that are mapped to any of a given set of (IPVC EP, CoS Name) pairs. This is one of the options for specifying BWP Flows described in Table 28. In this example, each BWP Flow is specified using a single (IPVC EP, CoS Name) pair. The IPVC EP Identifier is defined in Table 47 below, while the CoS Names are defined by IPVC List of Class of Service Names attribute in Table 44 above. The value of T<sub>E</sub> in the BWP Envelope is set to 2ms, which corresponds to a maximum burst size of 250kB at 1Gb/s.

Based on the above design for this example, if a new IPVC EP is added at the UNI with IPVC EP Identifier “IPVCEP.LONDON.02.01”, a corresponding new BWP Flow for that IPVC EP and Class of Service Name ‘Gold’ would be added to the Envelope, and an additional (IPVC EP, CoS Name) pair for the new IPVC EP would be added to the BWP Flow definition for each of the existing flows for the other CoS Names. The resulting new value for the UNI Ingress Bandwidth Profile Envelope Service Attribute is shown below:

```
( MaxIRE: 1000Mb/s,
  TE: 2 ms,
  Flows: [
    ( Flow Identifier: 1,
      Flow Definition:
        { ( IPVCEP.LONDON.01.01, Gold ) },
      CIR: 50,
      MaxIR: 50,
      Weight: 1,
      Burst Behavior: Optimize-Delay ),
    ( Flow Identifier: 5,
```

```

Flow Definition:
  { ( IPVCEP.LONDON.02.01, Gold ) },
CIR: 50,
MaxIR: 50,
Weight: 1,
Burst Behavior: Optimize-Delay ),
( Flow Identifier: 2,
  Flow Definition:
    { ( IPVCEP.LONDON.01.01, Silver ), ( IPVCEP.LONDON.02.01, Silver ) },
  CIR: 200,
  MaxIR: 1000,
  Weight: 6,
  Burst Behavior: Optimize-Throughput ),
( Flow Identifier: 3,
  Flow Definition:
    { ( IPVCEP.LONDON.01.01, Bronze ), ( IPVCEP.LONDON.02.01, Bronze ) },
  CIR: 200,
  MaxIR: 1000,
  Weight: 3,
  Burst Behavior: Optimize-Throughput ),
( Flow Identifier: 4,
  Flow Definition:
    { ( IPVCEP.LONDON.01.01, Lead ), ( IPVCEP.LONDON.02.01, Lead ) },
  CIR: 200,
  MaxIR: 1000,
  Weight: 1,
  Burst Behavior: Optimize-Throughput ) ] )

```

Table 46 shows the values of the UNI Access Link Service Attributes for the London UNI.

Service Attribute Name	Service Attribute Value
UNI Access Link Identifier	UNIAL.LONDON.01.01
UNI Access Link Connection Type	P2P
UNI Access Link L2 Technology	Ethernet, no C-tag, no S-tag, 1000 Base-T with Autonegotiation
UNI Access Link IPv4 Connection Addressing	( Type: Static, Primary IPv4 Prefix: 203.0.113.32/31, Primary SP IPv4 Addresses: [203.0.113.32], Primary Subscriber IPv4 Address: 203.0.113.33, Primary Reserved Prefixes: [ ], Secondary Subnets: [ ] )
UNI Access Link IPv6 Connection Addressing	None
UNI Access Link DHCP Relay	Disabled
UNI Access Link BFD	None
UNI Access Link IP MTU	1500

Service Attribute Name	Service Attribute Value
UNI Access Link Ingress Bandwidth Profile Envelope	None
UNI Access Link Egress Bandwidth Profile Envelope	None
UNI Access Link Reserved VRIDs	[ ]

**Table 46 – Example of UNI Access Link Service Attributes for the London UNI**

The UNI Access link for the London location identifies the static IP addresses supplied by the Service Provider as well as any other properties needed to connect to the Service Provider. In this case, a non-encapsulated Ethernet connection over a copper gigabit Ethernet cable.

Table 47 shows the values of the IPVC EP Service Attributes for the IPVC EP at the London UNI.

Service Attribute Name	Service Attribute Value
IPVC EP Identifier	IPVCEP.LONDON.01.01
IPVC EP EI	UNI.LONDON.01
IPVC EP Role	Root
IPVC EP Prefix Mapping	[ ]
IPVC EP Maximum Number of IPv4 Routes	150
IPVC EP Maximum Number of IPv6 Routes	0
IPVC EP Ingress Class of Service Map	( F: [ IP DS ], M: [ (40) → Gold, (46) → Gold, (32) → Silver, (34) → Silver, (36) → Silver, (38) → Silver, (18) → Bronze, (20) → Bronze, (22) → Bronze, (24) → Bronze, (26) → Bronze, (28) → Bronze, (30) → Bronze ], D: Lead )
IPVC EP Egress Class of Service Map	( D: None, P: None )
IPVC EP Ingress Bandwidth Profile Envelope	None
IPVC EP Egress Bandwidth Profile Envelope	None

**Table 47 – Example of IPVC EP Service Attributes at the London UNI**

The Subscriber IPVC End Point Attributes at this location show that the Role of this IPVC EP is Root, and that this IPVC EP may learn a maximum of 150 routes. The IPVC EP Prefix Mapping attribute is an empty list, indicating that there are no restrictions on which routes it may learn within the IPVC. In this example, the Service Provider and Subscriber agree, via the IPVC EP

Ingress Class of Service Map Service Attribute, on using IP DS for packet classification and mappings from the selected DSCP values to the four CoS Names defined by IPVC List of Class of Service Names attribute in Table 44.

The next three tables show the Service Attributes at the Tokyo office. Table 48 shows the values of the UNI Service Attributes for the Tokyo UNI.

Service Attribute Name	Service Attribute Value
UNI Identifier	UNI.TOKYO.01
UNI Management Type	Provider-Managed
UNI List of UNI Access Links	[ UNIAL.TOKYO.01.01 ]
UNI Ingress Bandwidth Profile Envelope	( MaxIR <sub>E</sub> : 1000Mb/s, T <sub>E</sub> : 2 ms, Flows: [ ( Flow Identifier: 1, Flow Definition: { ( IPVCEP.LONDON.01.01, Gold ) }, CIR: 50, MaxIR: 50, Weight: 1, Burst Behavior: Optimize-Delay ), ( Flow Identifier: 2, Flow Definition: { ( IPVCEP.LONDON.01.01, Silver ) }, CIR: 200, MaxIR: 1000, Weight: 6, Burst Behavior: Optimize-Throughput ), ( Flow Identifier: 3, Flow Definition: { ( IPVCEP.LONDON.01.01, Bronze ) }, CIR: 200, MaxIR: 1000, Weight: 3, Burst Behavior: Optimize-Throughput ), ( Flow Identifier: 4, Flow Definition: { ( IPVCEP.LONDON.01.01, Lead ) }, CIR: 200, MaxIR: 1000, Weight: 1, Burst Behavior: Optimize-Throughput ) ] )
UNI Egress Bandwidth Profile Envelope	None
UNI List of Control Protocols	[ ( Protocol: ICMP, Addressing: SP Addresses, Reference: RFC 792 ) ]
UNI Routing Protocols	[ ]

Service Attribute Name	Service Attribute Value
UNI Reverse Path Forwarding	Enabled

**Table 48 – Example of UNI Service Attributes for the Tokyo UNI**

In this example, the Tokyo office is using a Provider Managed CE Router with the statically assigned IP addresses. Again, the Subscriber and the Service Provider have agreed to identify ICMP in the UNI List of Control Protocols, but no other Control Protocols are identified.

No routing protocols are agreed as the Subscriber is directly connected. The Subscriber devices may need to be provided with a default gateway, which will be the UNI Access Link IPv4 Connection Address on the Primary Subnet.

Table 49 shows the values of the UNI Access Link Service Attributes for the Tokyo UNI.

Service Attribute Name	Service Attribute Value
UNI Access Link Identifier	UNIAL.TOKYO.01.01
UNI Access Link Connection Type	Multipoint
UNI Access Link L2 Technology	Ethernet, no C-tag, no S-tag, 1000 Base-T with Autonegotiation
UNI Access Link IPv4 Connection Addressing	( Type: Static, Primary IPv4 Prefix: 203.0.113.192/26, Primary SP IPv4 Addresses: [203.0.113.193], Primary Subscriber IPv4 Address: Not Specified, Primary Reserved Prefixes: [ ], Secondary Subnets: [ ] )
UNI Access Link IPv6 Connection Addressing	None
UNI Access Link DHCP Relay	Disabled
UNI Access Link BFD	None
UNI Access Link IP MTU	1500
UNI Access Link Ingress Bandwidth Profile Envelope	None
UNI Access Link Egress Bandwidth Profile Envelope	None
UNI Access Link Reserved VRIDs	[ ]

**Table 49 – Example of UNI Access Link Service Attributes for the Tokyo UNI**

Again, the UNI Access Link is identified as a Gigabit Ethernet cable, but as this UNI Access Link is identified as a UNI Access Link Type “Multipoint”, the Subscriber addresses are not specified. The subscriber may use any or all of the useable Primary Subnet IPv4 Addresses on the directly connected (at Layer 3) devices, except for 203.0.113.193, which is the address of the Service Provider’s interface, and should be used as the Subscriber’s nexthop.

Table 50 shows the values of the IPVC EP Service Attributes for the IPVC EP at the Tokyo UNI.

Service Attribute Name	Service Attribute Value
IPVC EP Identifier	IPVCEP.TOKYO.01.01
IPVC EP EI	UNI.TOKYO.01
IPVC EP Role	Root
IPVC EP Prefix Mapping	[ ]
IPVC EP Maximum Number of IPv4 Routes	1
IPVC EP Maximum Number of IPv6 Routes	0
IPVC EP Ingress Class of Service Map	( F: [ IP DS ], M: [ (40) → Gold, (46) → Gold, (32) → Silver, (34) → Silver, (36) → Silver, (38) → Silver, (18) → Bronze, (20) → Bronze, (22) → Bronze, (24) → Bronze, (26) → Bronze, (28) → Bronze, (30) → Bronze ], D: Lead )
IPVC EP Egress Class of Service Map	( D: None, P: None )
IPVC EP Ingress Bandwidth Profile Envelope	None
IPVC EP Egress Bandwidth Profile Envelope	None

**Table 50 – Example of IPVC EP Service Attributes at the Tokyo UNI**

The Subscriber IPVC End Point Attributes for Tokyo again identify the IPVC EP as having the role of Root, in keeping with the Multipoint topology of the IPVC, and the IPVC EP Prefix Mapping attribute is an empty list. The IPVC EP Maximum Number of IPv4 Routes attribute has been set to 1, as the Service Provider will only advertise the aggregate prefix of 203.0.113.192/26.

The next four tables show the Service Attributes at the San Francisco office. The San Francisco office has two UNI Access Links attached to the same UNI. Each of the UNI Access Links has a unique identifier. Table 51 shows the values of the UNI Service Attributes for the San Francisco UNI.

Service Attribute Name	Service Attribute Value
UNI Identifier	UNI.SFO.01
UNI Management Type	Subscriber-Managed
UNI List of UNI Access Links	[ UNIAL.SFO.01.01, UNIAL.SFO.01.02 ]



Service Attribute Name	Service Attribute Value
UNI Ingress Bandwidth Profile Envelope	( MaxIR <sub>E</sub> : 1000Mb/s, T <sub>E</sub> : 2 ms, Flows: [ ( Flow Identifier: 1, Flow Definition: { ( IPVCEP.LONDON.01.01, Gold ) }, CIR: 50, MaxIR: 50, Weight: 1, Burst Behavior: Optimize-Delay ), ( Flow Identifier: 2, Flow Definition: { ( IPVCEP.LONDON.01.01, Silver ) }, CIR: 200, MaxIR: 1000, Weight: 6, Burst Behavior: Optimize-Throughput ), ( Flow Identifier: 3, Flow Definition: { ( IPVCEP.LONDON.01.01, Bronze ) }, CIR: 200, MaxIR: 1000, Weight: 3, Burst Behavior: Optimize-Throughput ), ( Flow Identifier: 4, Flow Definition: { ( IPVCEP.LONDON.01.01, Lead ) }, CIR: 200, MaxIR: 1000, Weight: 1, Burst Behavior: Optimize-Throughput ) ] )
UNI Egress Bandwidth Profile Envelope	None
UNI List of Control Protocols	[ ( Protocol: ICMP, Addressing: SP Addresses, Reference: RFC 792 ), ( Protocol: BGP, Addressing: SP Addresses, Reference: RFC 4271 ), ( Protocol: BFD, Addressing: Any, Reference: RFC 5880 and RFC 5881 ) ]

Service Attribute Name	Service Attribute Value
UNI Routing Protocols	[ ( Protocol: BGP, Address Family: IPv4, Subscriber's AS Number: 65536, SP's AS Number: 64496, Connection Address Family: IPv4, Peering Addresses: Connection Addresses, Authentication: None, BGP Community List: [ ( 64496:90, Set Local Preference to 90 ), ( 64496:120, Set Local Preference to 120 ) ], BGP Extended Community List: [ ], Hold Time: 90, Damping: None, AS Override: Disabled Administrative Distance: 80 ) ]
UNI Reverse Path Forwarding	Enabled

**Table 51 – Example of UNI Service Attributes for the San Francisco UNI**

At this location, quick determination of a UNI Access Link fault is important to the Subscriber, and so BFD has been requested, and the required attributes have been agreed upon as shown below. BFD has been added to the UNI List of Control Protocols, along with ICMP.

The Subscriber has requested BGP routing protocol at this location, and so BGP has been added to the UNI List of Control Protocols. Additionally, the required BGP Attributes have been documented. As an example of the use of communities, this Service Provider has informed the Subscriber that they have communities for setting the Local Preference Attribute. This is particularly useful in this example where the Subscriber may want to load balance traffic on a per-prefix case. A real world solution will likely have a variety of communities or extended communities that are communicated between the Service Provider and the Subscriber. Note that the BGP Peering Addresses parameter is set to Connection Addresses, so there is a separate BGP session on each of the two UNI Access Links. The same values for the other parameters are used for both BGP sessions.

Table 52 and Table 53 show the values of the UNI Access Link Service Attributes for the two UNI Access Links in the San Francisco UNI.

Service Attribute Name	Service Attribute Value
UNI Access Link Identifier	UNIAL.SFO.01.01
UNI Access Link Connection Type	P2P
UNI Access Link L2 Technology	Ethernet, no C-tag, no S-tag, 1000 Base-T with Autonegotiation

Service Attribute Name	Service Attribute Value
UNI Access Link IPv4 Connection Addressing	( Type: Static, Primary IPv4 Prefix: 203.0.113.34/31, Primary SP IPv4 Addresses: [203.0.113.34], Primary Subscriber IPv4 Address: 203.0.113.35, Primary Reserved Prefixes: [ ], Secondary Subnets: [ ] )
UNI Access Link IPv6 Connection Addressing	None
UNI Access Link DHCP Relay	Disabled
UNI Access Link BFD	( Connection Address Family: IPv4, Transmission Interval: 100, Detect Multiplier: 3, Active End: Subscriber, Authentication Type: None )
UNI Access Link IP MTU	1500
UNI Access Link Ingress Bandwidth Profile Envelope	None
UNI Access Link Egress Bandwidth Profile Envelope	None
UNI Access Link Reserved VRIDs	[ ]

**Table 52 – Example of UNI Access Link Service Attributes for the San Francisco UNI (Link 1)**

Service Attribute Name	Service Attribute Value
UNI Access Link Identifier	UNIAL.SFO.01.02
UNI Access Link Connection Type	P2P
UNI Access Link L2 Technology	Ethernet, C-tag with VID 100, no S-tag, 1000 Base-SX with Autonegotiation
UNI Access Link IPv4 Connection Addressing	( Type: Static, Primary IPv4 Prefix: 203.0.113.36/31, Primary SP IPv4 Addresses: [203.0.113.36], Primary Subscriber IPv4 Address: 203.0.113.37, Primary Reserved Prefixes: [ ], Secondary Subnets: [ ] )
UNI Access Link IPv6 Connection Addressing	None
UNI Access Link DHCP Relay	Disabled

Service Attribute Name	Service Attribute Value
UNI Access Link BFD	( Connection Address Family: IPv4, Transmission Interval: 100, Detect Multiplier: 3, Active End: Subscriber, Authentication Type: None )
UNI Access Link IP MTU	1500
UNI Access Link Ingress Bandwidth Profile Envelope	None
UNI Access Link Egress Bandwidth Profile Envelope	None
UNI Access Link Reserved VRIDs	[ ]

**Table 53 – Example of UNI Access Link Service Attributes for the San Francisco UNI (Link 2)**

As shown above, each UNI Access Link has a unique identifier, connection address scheme and Layer 2 information. The UNI Access Link IPv4 Connection Addressing Primary Subnet Addresses are used to establish the BGP session over each of the UNI Access Links.

For illustration, different media have been identified for the two UNI Access Links. The IP Service Attributes do not specify whether these UNI Access Links connect to the same CE router or different CE routers, or whether they connect to the same PE router or different PE routers.

Table 54 shows the values of the IPVC EP Service Attributes for the IPVC EP at the San Francisco UNI.

Service Attribute Name	Service Attribute Value
IPVC EP Identifier	IPVCEP.SFO.01.01
IPVC EP EI	UNI.SFO.01
IPVC EP Role	Root
IPVC EP Prefix Mapping	[ ]
IPVC EP Maximum Number of IPv4 Routes	300
IPVC EP Maximum Number of IPv6 Routes	0

Service Attribute Name	Service Attribute Value
IPVC EP Ingress Class of Service Map	( F: [ IP DS ], M: [ (40) → Gold, (46) → Gold, (32) → Silver, (34) → Silver, (36) → Silver, (38) → Silver, (18) → Bronze, (20) → Bronze, (22) → Bronze, (24) → Bronze, (26) → Bronze, (28) → Bronze, (30) → Bronze ], D: Lead )
IPVC EP Egress Class of Service Map	( D: None, P: None )
IPVC EP Ingress Bandwidth Profile Envelope	None
IPVC EP Egress Bandwidth Profile Envelope	None

**Table 54 – Example of IPVC EP Service Attributes at the San Francisco UNI**

In this example of a standard routing Multipoint IPVC, the IPVC EP attributes look similar to those at the other sites. A higher number of IPv4 routes is specified than would be necessary for aggregate routing to accommodate longer prefix matching, though that detail is up to the discretion of the Service Provider.

One way to implement a fully meshed Multipoint IPVC with no prefix filtering is to use a single VRF using an MP-BGP based VPN using the VPNv4 address family. Each site will have a Route Distinguisher assigned. A single Route Target can be used to simplify the implementation. In the simplest implementation, each UNI Access Link would be an interface in the same VRF.

Alternatively, each UNI Access Link could be in its own VRF, and the Service Provider may then assign a different Route Distinguisher for prefixes learned over each UNI Access Link at the San Francisco location, which would ensure that duplicate IPv4 addresses would have unique VPNv4 addresses. This could enable the Subscriber to advertise routes from both UNI Access Links to enable the Subscriber to use ECMP, for example.

## C.2 Rooted Multipoint IPVC Example

This example uses the same Subscriber as above, Bank of MEF, with sites at San Francisco, London, and Tokyo. The Subscriber has modified their request, however, such that all traffic may not be passed directly between London and Tokyo. In this instance, the values for the Subscriber IPVC Service Attributes for IPVC Topology are changed to reflect a value of Rooted Multipoint. The values of the Subscriber UNI Attributes and Subscriber UNI Access Link Attributes could all be the same (assuming no other parameters have been requested to be modified). The Subscriber

IPVC End Point Attributes are modified such that the roles of the IPVC EPs at London and at Tokyo are changed to “Leaf”.

Table 55, Table 56, Table 57 and Table 58 show the values of the Subscriber IPVC Service Attributes for the IPVC and the value of the IPVC EP Service Attributes for the three IPVC EPs. The values that are changed, compared to the previous example, are shown in bold.

Service Attribute Name	Service Attribute Value
IPVC Identifier	IPVC.000001
IPVC Topology	<b>Rooted Multipoint</b>
IPVC End Point List	[ IPVCEP.LONDON.01.01, IPVCEP.SANFRANCISCO.01.01, IPVCEP.TOKYO.01.01 ]
IPVC Packet Delivery	Standard Routing
IPVC Maximum Number of IPv4 Routes	400
IPVC Maximum Number of IPv6 Routes	0
IPVC DSCP Preservation	Enabled
IPVC List of Class of Service Names	[ Gold, Silver, Bronze, Lead ]
IPVC Service Level Specification	( s: 00:00:00 on 1 July 2017, T: 1 Calendar Month, E: { ( Metric: One-way Packet Loss Ratio, C: Gold, S: {(IPVCEP.TOKYO.01.01, London), (London, IPVCEP.TOKYO.01.01)}, F̂: 0.1% ) }, L: { ( Name: London, Description: London Docklands IPVC EPs: [ IPVCEP.LONDON.01.01 ] ) } )
IPVC MTU	1500
IPVC Path MTU Discovery	Enabled
IPVC Fragmentation	Enabled
IPVC Cloud	None
IPVC Reserved Prefixes	[ 203.0.113.0/27 ]

**Table 55 – Example of Subscriber IPVC Service Attributes for a Rooted Multipoint IP VPN**

Service Attribute Name	Service Attribute Value
IPVC EP Identifier	IPVCEP.LONDON.01.01
IPVC EP EI	UNI.LONDON.01
IPVC EP Role	<b>Leaf</b>
IPVC EP Prefix Mapping	[ ]
IPVC EP Maximum Number of IPv4 Routes	150

Service Attribute Name	Service Attribute Value
IPVC EP Maximum Number of IPv6 Routes	0
IPVC EP Ingress Class of Service Map	( F: [ IP DS ], M: [ (40) → Gold, (46) → Gold, (32) → Silver, (34) → Silver, (36) → Silver, (38) → Silver, (18) → Bronze, (20) → Bronze, (22) → Bronze, (24) → Bronze, (26) → Bronze, (28) → Bronze, (30) → Bronze ], D: Lead )
IPVC EP Egress Class of Service Map	( D: None, P: None )
IPVC EP Ingress Bandwidth Profile Envelope	None
IPVC EP Egress Bandwidth Profile Envelope	None

**Table 56 – Example of IPVC EP Service Attributes at the London UNI for Rooted Multipoint**

Service Attribute Name	Service Attribute Value
IPVC EP Identifier	IPVCEP.TOKYO.01.01
IPVC EP EI	UNI.TOKYO.01
IPVC EP Role	<b>Leaf</b>
IPVC EP Prefix Mapping	[ ]
IPVC EP Maximum Number of IPv4 Routes	1
IPVC EP Maximum Number of IPv6 Routes	0

Service Attribute Name	Service Attribute Value
IPVC EP Ingress Class of Service Map	( F: [ IP DS ], M: [ (40) → Gold, (46) → Gold, (32) → Silver, (34) → Silver, (36) → Silver, (38) → Silver, (18) → Bronze, (20) → Bronze, (22) → Bronze, (24) → Bronze, (26) → Bronze, (28) → Bronze, (30) → Bronze ], D: Lead )
IPVC EP Egress Class of Service Map	( D: None, P: None )
IPVC EP Ingress Bandwidth Profile Envelope	None
IPVC EP Egress Bandwidth Profile Envelope	None

**Table 57 – Example of IPVC EP Service Attributes at the Tokyo UNI for Rooted Multipoint**

Service Attribute Name	Service Attribute Value
IPVC EP Identifier	IPVCEP.SFO.01.01
IPVC EP EI	UNI.SFO.01
IPVC EP Role	Root
IPVC EP Prefix Mapping	[ ]
IPVC EP Maximum Number of IPv4 Routes	300
IPVC EP Maximum Number of IPv6 Routes	0
IPVC EP Ingress Class of Service Map	( F: [ IP DS ], M: [ (40) → Gold, (46) → Gold, (32) → Silver, (34) → Silver, (36) → Silver, (38) → Silver, (18) → Bronze, (20) → Bronze, (22) → Bronze, (24) → Bronze, (26) → Bronze, (28) → Bronze, (30) → Bronze ], D: Lead )



Service Attribute Name	Service Attribute Value
IPVC EP Egress Class of Service Map	( D: None, P: None )
IPVC EP Ingress Bandwidth Profile Envelope	None
IPVC EP Egress Bandwidth Profile Envelope	None

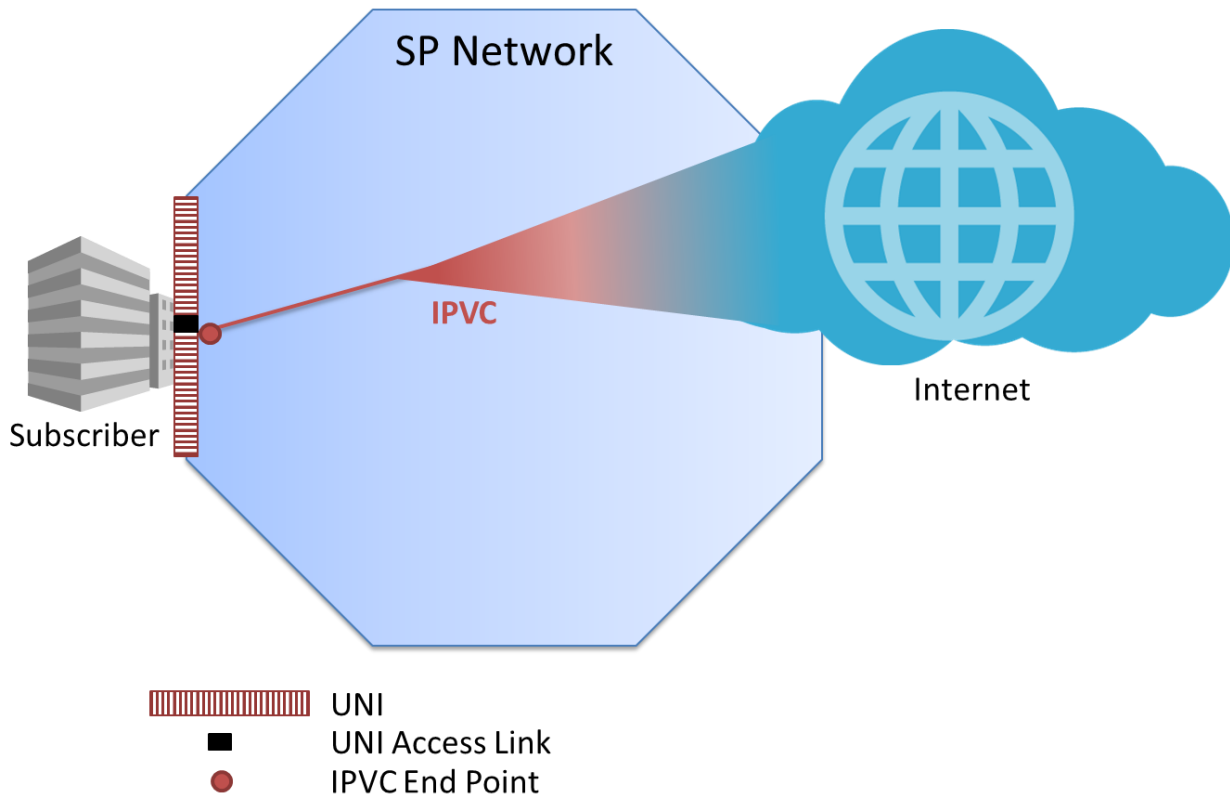
**Table 58 – Example of IPVC EP Service Attributes at the San Francisco UNI for Rooted Multipoint**

A Service Provider could implement this solution using an MP-BGP based VPN. One implementation would have two Route Targets assigned, one would be assigned to the Root(s), the other would be assigned to the Leaf(s). A Route Target policy would be used to ensure that prefixes learned from Leaf Route Targets could only be advertised to the Root(s) while each site could advertise the prefixes learned from the Root Route Targets.

Alternatively, each location could be assigned its own Route Target, and a more detailed policy could be used to allow the Root(s) to learn the prefixes advertised by the Leaf(s).

### C.3 Internet Access Example

In this example, the Bank of MEF would like to connect their head office to the public Internet. They therefore request a cloud access IPVC.



**Figure 64 – Example Cloud Access IPVC for Internet Access**

The tables below show the values of all of the Service Attributes. In this example, the Internet access service provides dual-stack connectivity. The Subscriber has been assigned a /29 (IPv4) prefix and a /56 (IPv6) prefix. Again, documentation space is used here, but in reality these would be taken from public address space. The Service Provider and Subscriber do not exchange Internet routing information. The service provides a single best-effort Class of Service. The IP MTU for this IPVC is 1500 bytes. NAT for IPv4 traffic is performed by the Subscriber. DNS service is provided by the Service Provider, with the DNS servers sent via DHCP.

Table 59 shows the values of the Subscriber IPVC Service Attributes for the IPVC.

Service Attribute Name	Service Attribute Value
IPVC Identifier	IPVC.00066.1
IPVC Topology	Cloud Access
IPVC End Point List	[ IPVCEP.Budapest.66.01 ]
IPVC Packet Delivery	Standard Routing
IPVC Maximum Number of IPv4 Routes	1
IPVC Maximum Number of IPv6 Routes	1
IPVC DSCP Preservation	Disabled
IPVC List of Class of Service Names	[ Best-effort ]
IPVC Service Level Specification	( s: 00:00:00 on 1 July 2017, T: 1 Calendar Month, E: { ( Metric: Service Uptime, $\hat{U}$ : 99% ) }, L: { } )
IPVC MTU	1500
IPVC Path MTU Discovery	Enabled
IPVC Fragmentation	Disabled
IPVC Cloud	( Type: Internet Access, Ingress CoS Map: (F: IP DS, M: [ ], D: Best-effort ), Cloud Data Limit: Unlimited, NAT: Disabled, DNS: DHCP, Subscriber Prefixes: [ 192.0.2.0/29, 2001:0DB8:0066::/56 ] )
IPVC Reserved Prefixes	[ 203.0.113.0/27, 2001:0DB8::/64 ]

**Table 59 – Example of Subscriber IPVC Service Attributes for a Cloud Access IPVC**

The Service Level Specification shows an example on service uptime (99%). How this is measured is outside the scope of this document. As there is only a single Class of Service identified by the Service Provider, the Cloud Ingress CoS Map identifies that the CoS Name “Best-effort” is the default Class of Service, with no further definitions.

Table 60 shows the values of the UNI Service Attributes for the UNI.

Service Attribute Name	Service Attribute Value
UNI Identifier	UNI.Budapest.66.1
UNI Management Type	Subscriber-Managed
UNI List of UNI Access Links	[ UNIAL.Budapest.66.1.1 ]
UNI Ingress Bandwidth Profile Envelope	None
UNI Egress Bandwidth Profile Envelope	None
UNI List of Control Protocols	[ ( Protocol: ICMP, Addressing: SP Addresses, Reference: RFC 792 ), ( Protocol: DHCP, Addressing: Any, Reference: RFC 2131 and RFC 2132 ), ( Protocol: DHCPv6, Addressing: Any, Reference: RFC 8415 ) ]
UNI Routing Protocols	[ ( Type: Static, Address Family: Both, Prefixes: [ ( Prefix: 192.0.2.0/29, Nexthop: 203.0.113.1, Admin Distance: 10 ), ( Prefix: 2001:0DB8:0066::/56, Nexthop: 2001:0DB8:0066::2, Admin Distance: 10 ) ] ) ]
UNI Reverse Path Forwarding	Enabled

**Table 60 – Example of UNI Service Attributes for a Cloud Access service**

In this example, the Subscriber location has a Subscriber managed router on site. Static routing is used; for IPv6, this is with an aggregate prefix that is a superset of the IP Prefix used for connection addressing (see below).

Table 61 shows the values of the UNI Access Link Service Attributes.

Service Attribute Name	Service Attribute Value
UNI Access Link Identifier	UNIAL.Budapest.66.1.1
UNI Access Link Connection Type	P2P

Service Attribute Name	Service Attribute Value
UNI Access Link L2 Technology	Ethernet, C-tag with VID 66, no S-tag, 1000 Base-SX, GE/FD
UNI Access Link IPv4 Connection Addressing	( Type: Static, Primary IPv4 Prefix: 203.0.113.0/31, Primary SP IPv4 Addresses: [203.0.113.0], Primary Subscriber IPv4 Address: 203.0.113.1, Primary Reserved Prefixes: [ ], Secondary Subnets: [ ] )
UNI Access Link IPv6 Connection Addressing	( Type: DHCP, Subnets: [ ( IPv6 Prefix: 2001:0DB8:0066::/64, SP IPv6 Address: [2001:0DB8:0066::1], Reserved Prefixes: [ 2001:0DB8:0066:0:1::/80 ] ) ] )
UNI Access Link DHCP Relay	Disabled
UNI Access Link BFD	None
UNI Access Link IP MTU	1500
UNI Access Link Ingress Bandwidth Profile Envelope	None
UNI Access Link Egress Bandwidth Profile Envelope	None
UNI Access Link Reserved VRIDs	[ ]

**Table 61 – Example of UNI Access Link Service Attributes for a Cloud Access Service**

The UNI Access link for the Budapest location receives IP addresses via DHCP over an optical Gigabit Ethernet connection.

Table 62 shows the values of the IPVC EP Service Attributes for the IPVC EP.

Service Attribute Name	Service Attribute Value
IPVC EP Identifier	IPVCEP.Budapest.66.1
IPVC EP EI	UNI.Budapest.66.1
IPVC EP Role	Root
IPVC EP Prefix Mapping	[ ]
IPVC EP Maximum Number of IPv4 Routes	1
IPVC EP Maximum Number of IPv6 Routes	1
IPVC EP Ingress Class of Service Map	( F: IP DS, M: [ ], D: Best-effort )
IPVC EP Egress Class of Service Map	( D: None, P: None )
IPVC EP Ingress Bandwidth Profile Envelope	None

Service Attribute Name	Service Attribute Value
IPVC EP Egress Bandwidth Profile Envelope	None

**Table 62 – Example of IPVC EP Service Attributes for a Cloud Access service**

## Appendix D Examples for Operator IP Services (Informative)

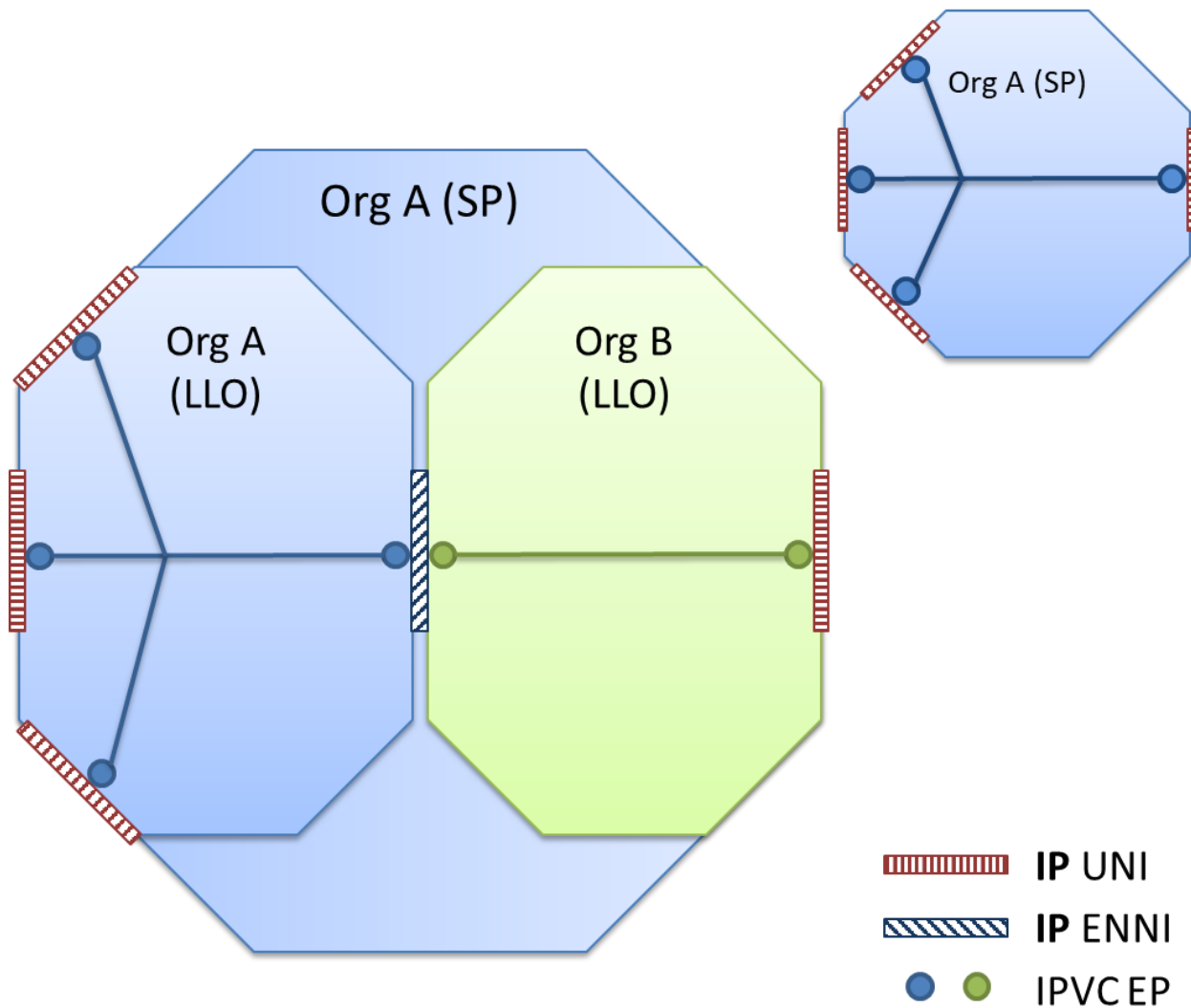
This Appendix contains several examples relating to Operator IP Services.

### D.1 Use Cases

The subsections below illustrate some different ways that Operator IP Services can be used. Note that these are examples only.

#### D.1.1 Access to a Single Remote UNI

Consider a case where a Subscriber has obtained a multipoint Subscriber IP Service connecting four UNIs from an SP, Org A. The Subscriber's view of the service is shown in the top right of Figure 65. The SP can support three of the UNIs directly, but needs to use an Operator IP Service from Org B to access the UNI on the right. This is connected across an ENNI to another Operator IP Service within Org A's network, thus implementing the overall Subscriber IP Service. Org A's view is shown in the main part of Figure 65.



**Figure 65 – Access to a Single Remote UNI**

In this case, the Service Attributes that are agreed are as follows:

- Agreed between the Subscriber and Org A (acting as the SP), for the Subscriber IP Service:
  - IPVC Service Attributes for the Subscriber IPVC.
  - IPVC EP Service Attributes for each of the four IPVC EPs.
  - UNI Service Attributes for each of the four UNIs.
  - UNI Access Link Service Attributes for the UNI Access Links at each UNI.
- Agreed between Org A (acting as an LLO) and Org B:
  - ENNI Common Attributes for the ENNI.
  - ENNI Link Attributes for each ENNI Link in the ENNI.
- Agreed between Org A (acting as the SP) and Org B, for the Operator IP Service provided by Org B:
  - IPVC Service Attributes for the Operator IPVC in Org B.
  - IPVC EP Service Attributes for both of the IPVC EPs.

- UNI Service Attributes for the UNI on the right.
- UNI Access Link Service Attributes for each UNI Access Link in that UNI.
- ENNI Service Attributes for the ENNI.

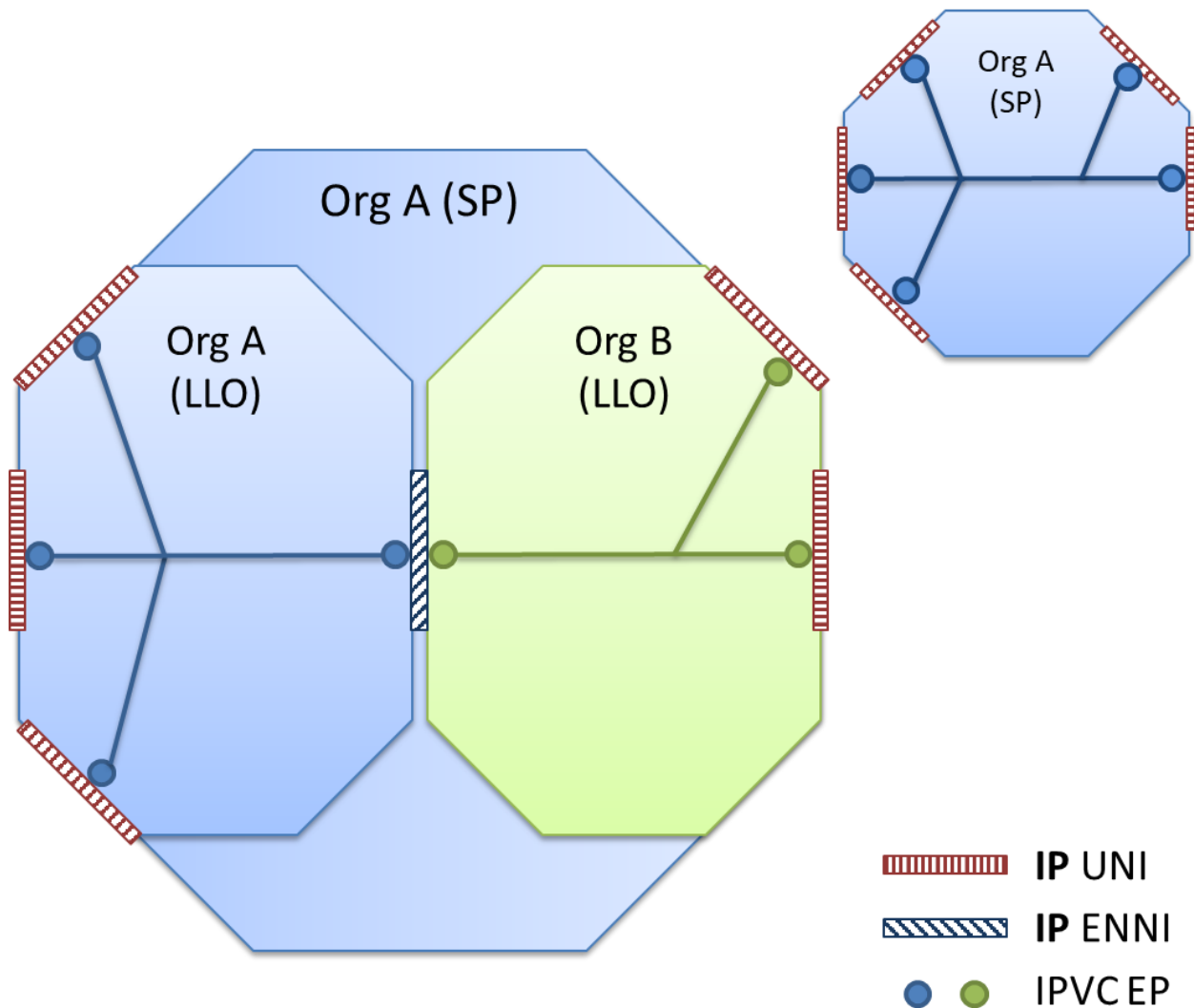
Logically, Org A (acting as the SP) also agrees on a set of attributes with Org A (acting as the LLO), relating to the Operator IPVC within Org A's network; these would be similar to the final set described above. However, since in this example, the same organization is acting as both the SP and as an LLO, it is an internal matter for that organization as to whether such attributes are actually used in practice.

Note that this case illustrates the SP using an IP Service to access the remote UNI. The SP could alternatively use an Ethernet service, as described in Appendix E.

### **D.1.2 Access to Multiple Remote UNIs**

After acquiring the IP Service described above, the Subscriber might subsequently want to add an additional UNI. The SP, Org A, again needs to use Org B to access this new UNI. This can be done by adding the new UNI to the existing Operator IP Service, as shown in Figure 66. Again, the Subscriber's view is shown in the top right, and Org A's view in the main part of the figure.

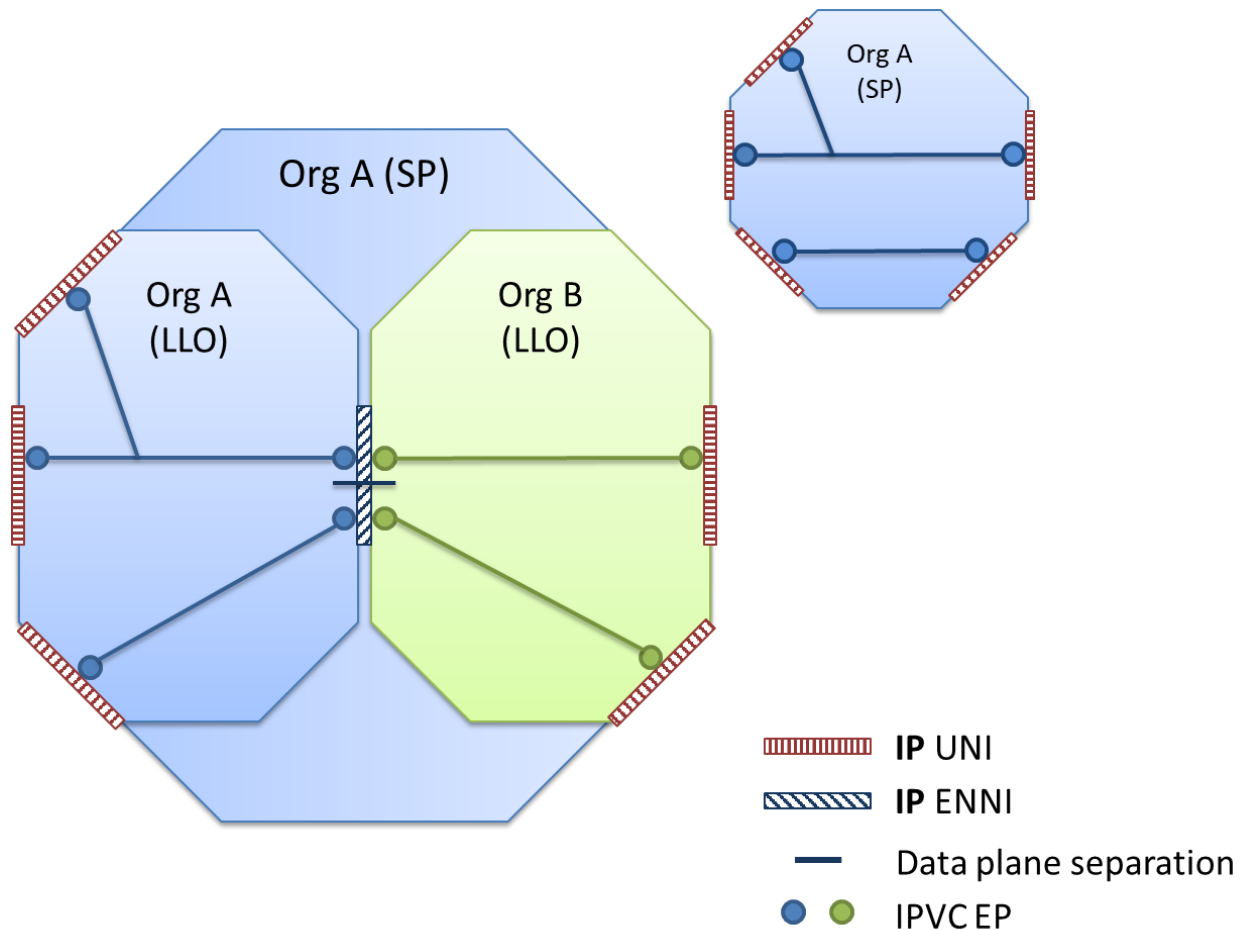




**Figure 66 – Access to Multiple Remote UNIs**

### D.1.3 Multiple Services at an ENNI

Figure 67 shows an example where the SP, Org A, is providing two Subscriber IP Services, one connecting three UNIs and the other connecting two UNIs, as shown in the top right of the figure. For both of these Subscriber IP Services, they need to use Org B to reach one of the UNIs; hence they use two Operator IP Services from Org B, as shown in the main part of the figure. The bar shown across the ENNI illustrates that the data plane for the two services is kept separate at the ENNI; in the case of Option A, this is by assigning different ENNI Links to carry the two services.



**Figure 67 – Multiple Services at an ENNI**

In this case, the Service Attributes that are agreed are as follows:

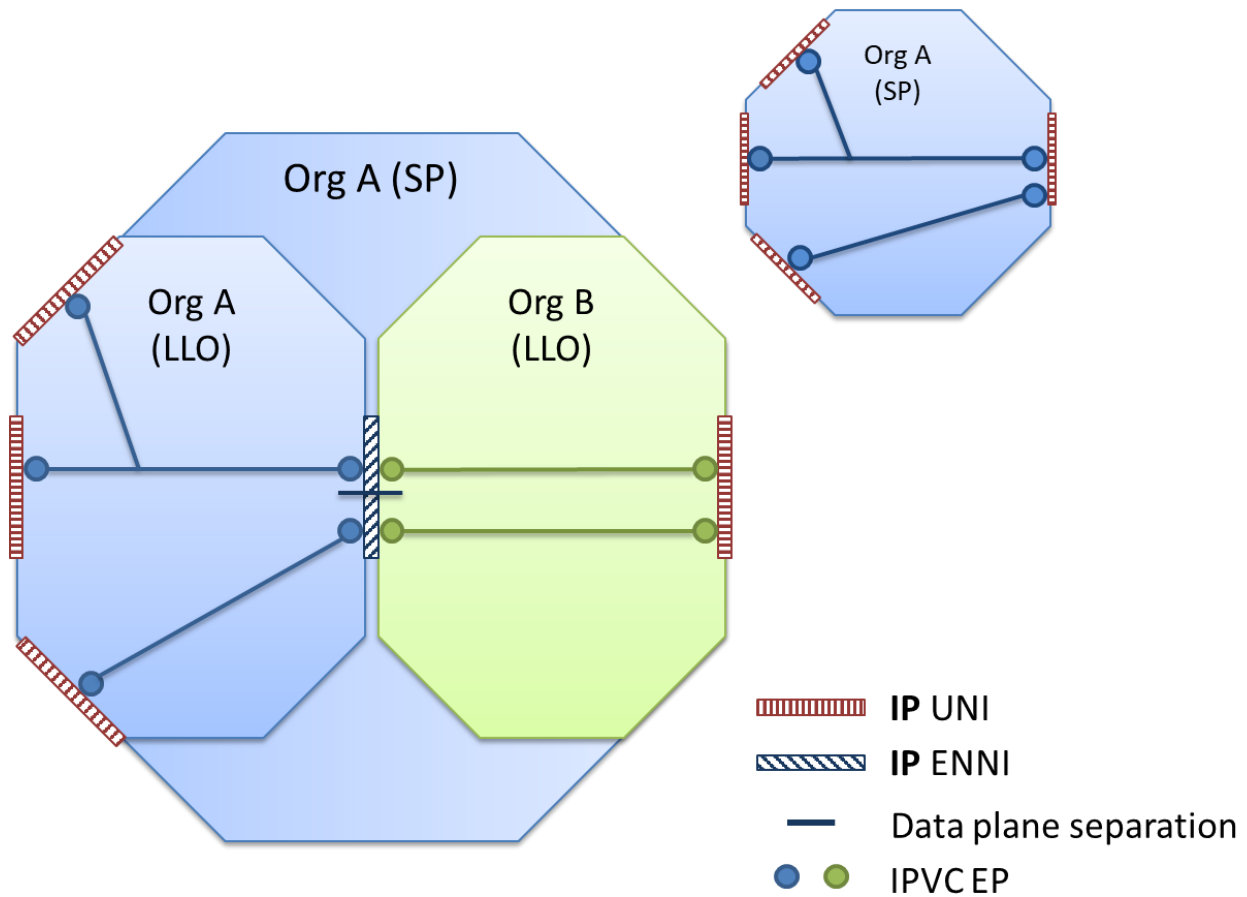
- Agreed between Subscriber 1 and Org A (acting as the SP), for the top Subscriber IP Service:
  - IPVC Service Attributes for the Subscriber IPVC.
  - IPVC EP Service Attributes for each of the three IPVC EPs.
  - UNI Service Attributes for each of the three UNIs.
  - UNI Access Link Service Attributes for the UNI Access Links at each UNI.
- Agreed between Subscriber 2 and Org A (acting as the SP), for the bottom Subscriber IP Service:
  - IPVC Service Attributes for the Subscriber IPVC.
  - IPVC EP Service Attributes for both of the IPVC EPs.
  - UNI Service Attributes for both of the UNIs.
  - UNI Access Link Service Attributes for the UNI Access Links at each UNI.
- Agreed between Org A (acting as an LLO) and Org B:
  - ENNI Common Attributes for the ENNI.
  - ENNI Link Attributes for each ENNI Link in the ENNI.
- Agreed between Org A (acting as the SP) and Org B, common to all services provided by Org B to Org A:

- ENNI Service Attributes for the ENNI.
- Agreed between Org A (acting as the SP) and Org B, for the top Operator IP Service provided by Org B:
  - IPVC Service Attributes for the Operator IPVC in Org B.
  - IPVC EP Service Attributes for both of the IPVC EPs.
  - UNI Service Attributes for the UNI.
  - UNI Access Link Service Attributes for each UNI Access Link in that UNI.
- Agreed between Org A (acting as the SP) and Org B, for the bottom Operator IP Service provided by Org B:
  - IPVC Service Attributes for the Operator IPVC in Org B.
  - IPVC EP Service Attributes for both of the IPVC EPs.
  - UNI Service Attributes for the UNI.
  - UNI Access Link Service Attributes for each UNI Access Link in that UNI.

As in previous cases, Org A (acting as the SP) logically needs to agree on attributes with themselves (acting as the LLO) in respect of the Operator IP Services within their own network, but in practice that might be skipped as in this example, it is the same organization in both roles.

#### D.1.4 Multiple Services at a Single Remote UNI

In this example, the Subscriber acquires a Subscriber IP Service connecting three UNIs from the SP, Org A. The UNI on the right also needs to connect to an extranet available at the UNI on the bottom left, so the Subscriber acquires another Subscriber IP Service for this purpose, as shown in the top right of Figure 68. As before, Org A needs to use Org B to reach the UNI on the right. In this example, they use two independent Operator IP Services between the ENNI and the UNI. At the ENNI, the data plane is separated between the two services – in the case of Option A, by assigning different ENNI Links to each service.



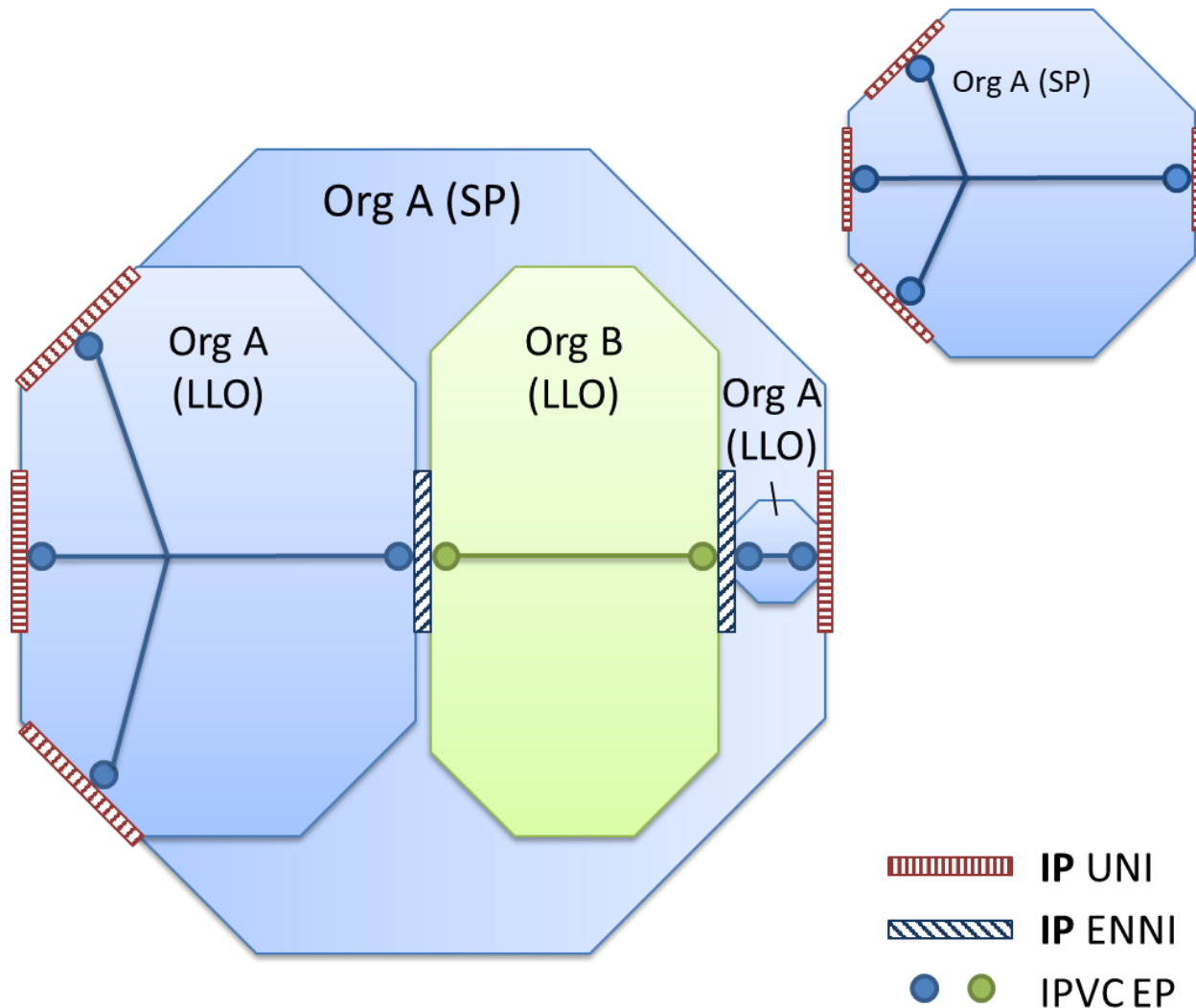
**Figure 68 – Multiple Services at a Single Remote UNI**

In this case, the Service Attributes that are agreed are as follows:

- Agreed between the Subscriber and Org A (acting as the SP):
  - IPVC Service Attributes for the two Subscriber IPVCs.
  - IPVC EP Service Attributes for each of the five IPVC EPs.
  - UNI Service Attributes for each of the four UNIs.
  - UNI Access Link Service Attributes for the UNI Access Links at each UNI.
- Agreed between Org A (acting as an LLO) and Org B:
  - ENNI Common Attributes for the ENNI.
  - ENNI Link Attributes for each ENNI Link in the ENNI.
- Agreed between Org A (acting as the SP) and Org B, for the Operator IP Services provided by Org B:
  - IPVC Service Attributes for the two Operator IPVCs in Org B.
  - IPVC EP Service Attributes for each of the four IPVC EPs.
  - UNI Service Attributes for the UNI.
  - UNI Access Link Service Attributes for each UNI Access Link in that UNI.
  - ENNI Service Attributes for the ENNI.

### D.1.5 Access to a Remote Managed CPE

Figure 69 shows a case where the SP uses another Operator to reach a remote UNI, but places their own device (for example a managed CPE) at the Subscriber’s premises. This case is similar to that shown in Figure 65 in section D.1.1 – indeed, the service seen by the Subscriber is identical. The difference is that in this case, the SP, Org A, has placed their own equipment at the Subscriber’s premises.



**Figure 69 – Operator Transit Service Connecting an SP Managed CPE**

The SP’s managed CPE is shown in this figure on the right, as a separate IPVC belonging to Org A (acting as an LLO), with two IPVC EPs. In this case, the IPVC and the two IPVC EPs are all implemented within a single device, i.e. the managed CPE.

In this example, the interface between Org A’s managed CPE and Org B’s network is, by definition, an ENNI (since it is the boundary of responsibility between two Operators, Org A and Org B, and not between an SP and the Subscriber). However, it is a much more limited type of ENNI than the more general case, in that it only supports services for a single Subscriber, being provided

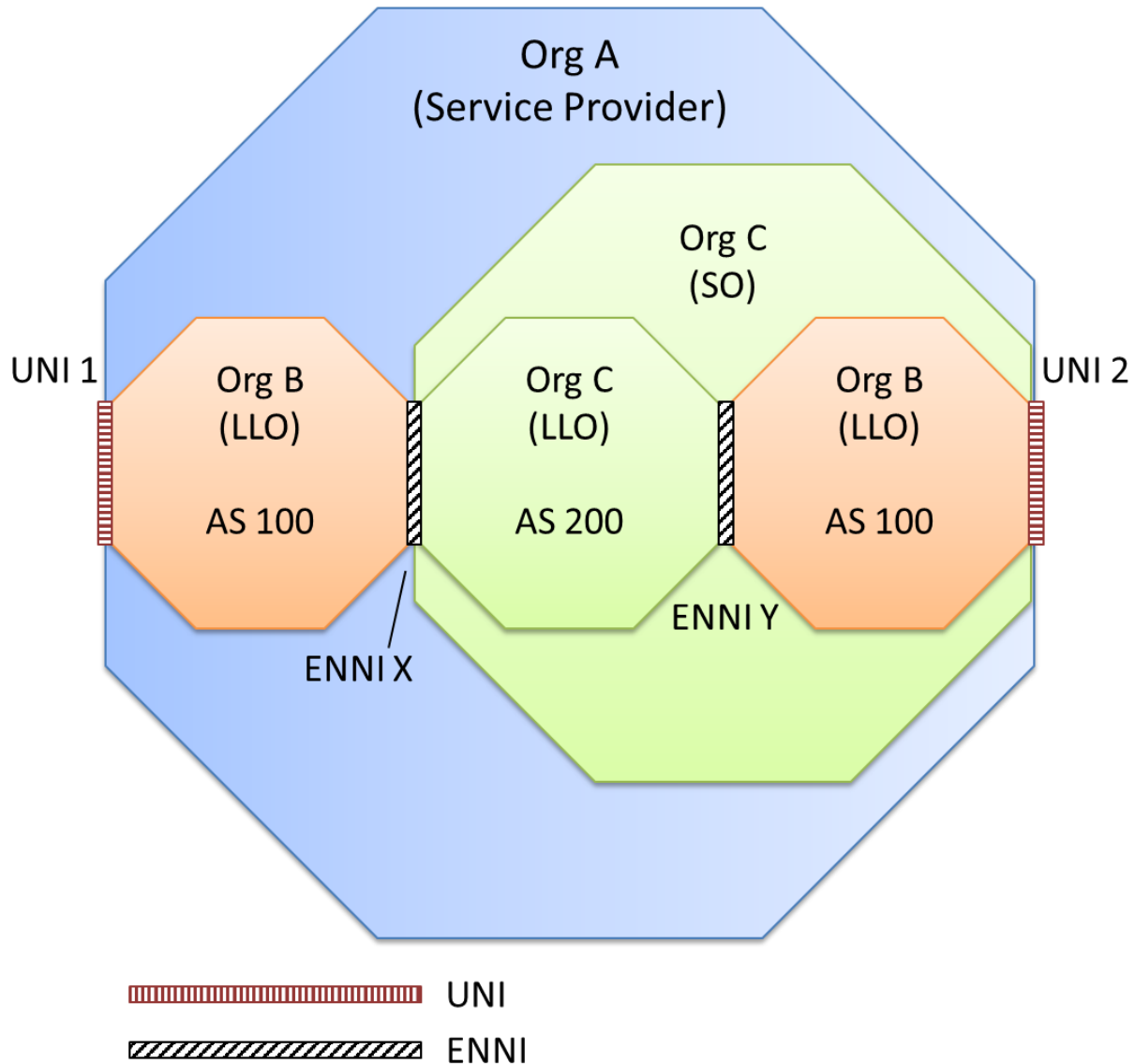
by a single SP. From Org B's perspective, such an ENNI may be indistinguishable, in terms of the required behavior, from a UNI.

Note that this version of the specification makes no special provision for such an ENNI; as such, the same attributes need to be agreed for this ENNI as for any other. The Service Attributes that are agreed in this example are as follows:

- Agreed between the Subscriber and Org A (acting as the SP), for the Subscriber IP Service:
  - IPVC Service Attributes for the Subscriber IPVC.
  - IPVC EP Service Attributes for each of the four IPVC EPs.
  - UNI Service Attributes for each of the four UNIs.
  - UNI Access Link Service Attributes for the UNI Access Links at each UNI.
- Agreed between Org A (acting as an LLO) and Org B:
  - ENNI Common Attributes for each of the two ENNIs.
  - ENNI Link Attributes for each ENNI Link in each of the two ENNIs.
- Agreed between Org A (acting as the SP) and Org B, for the Operator IP Service provided by Org B:
  - IPVC Service Attributes for the Operator IPVC in Org B.
  - IPVC EP Service Attributes for both of the IPVC EPs.
  - ENNI Service Attributes for both of the ENNIs.

## D.2 Use of AS Override at an ENNI

As described in section 14.3.1.3, there are some situations in which it is useful for a SP/SO to agree with an Operator that AS Override will be used for routes for a given IP Service advertised over an ENNI. One such situation is illustrated in Figure 70.



**Figure 70 – Example of AS Override at an ENNI**

In this example, Organization A (the Service Provider) is providing a Subscriber IP Service between UNI 1 and UNI 2. To implement this, they arrange two Operator IP Services: one with Organization B between UNI 1 and ENNI X, and another with Organization C between UNI 2 and ENNI X. However, Organization C acts as an SO, and divides their Operator IP Service into two further sub-services: one that they provide themselves, between the two ENNIs, and one that they agree with Organization B, between UNI 2 and ENNI Y.

It can be immediately seen that this scenario is problematic for BGP routing, since routes received from Organization B at one ENNI will be advertised back to Organization B at the other ENNI, and thus BGP’s AS Path loop detection will kick in and cause all the routes to be discarded. The situation is analogous to the problem for Subscribers when BGP is used at the UNI (see section 12.7.3), except that in that case the SP can always anticipate the issue.

Note that in this scenario, Organization B is unaware that the two Operator IP Services they are providing are related in any way. They provide one service to Organization A between UNI 1 and ENNI X, and another service to Organization B between UNI 2 and ENNI Y, so the two services have nothing in common. In addition, Organization A is also unaware of the problem as they do not know that Organization C is using Organization B to implement part of the service that Organization C is providing to Organization A. In this particular scenario, only Organization C can anticipate the problem, since (as an LLO) they are peering with Organization B at two different ENNIs.

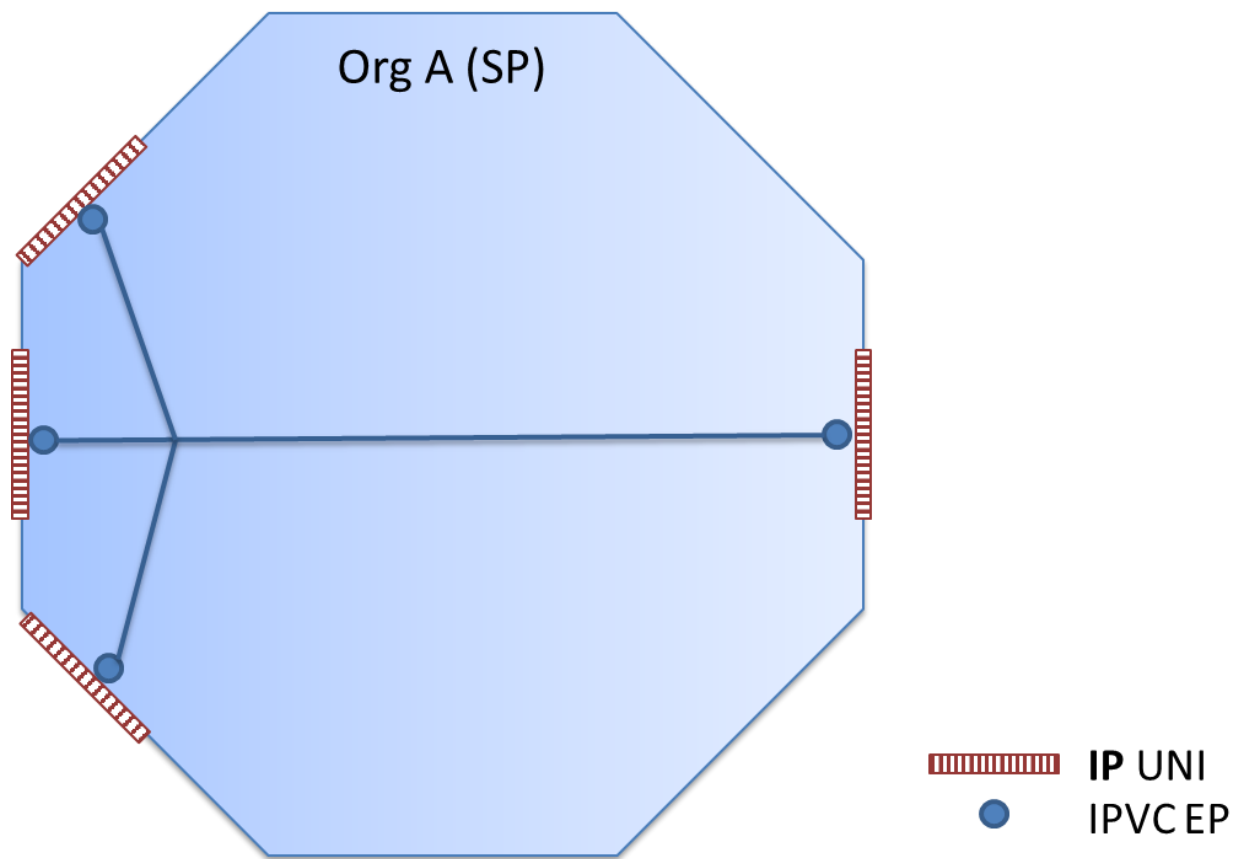
One solution to this is for Organization C to use AS Override at both the ENNIs. This can be agreed with the SP using the ENNI Routing Information Service Attribute (section 14.3). It is important in this case that it is the peer Operator's AS Number (i.e., Organization B's AS Number in this example) that is overridden, since if the Subscriber peers BGP at the UNI, the Subscriber's AS Number will also appear in the AS Path, before the peer Operator's. In other words, it cannot be assumed that Organization B's AS Number, 100, represents the origin AS.



## Appendix E Using Ethernet Access to Implement IP Services (Informative)

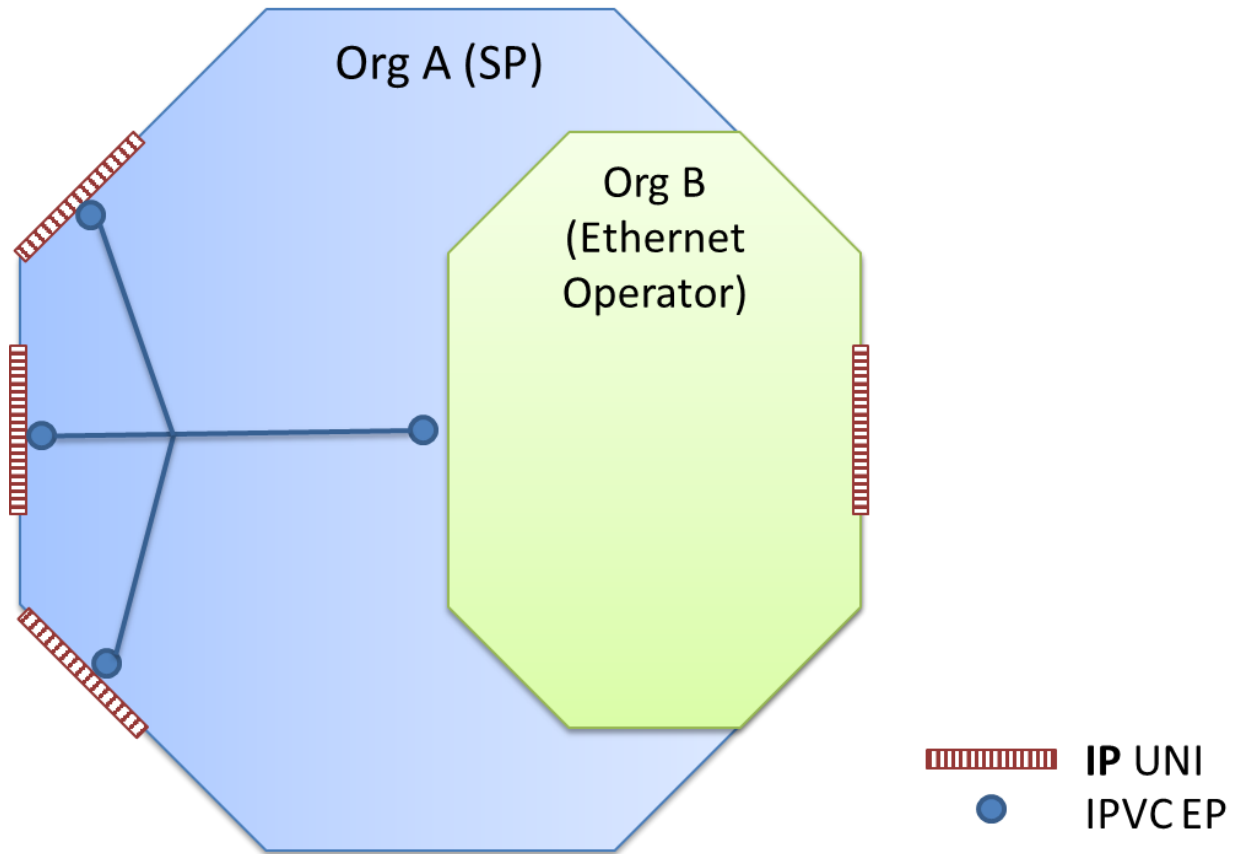
When a Subscriber acquires an IP Service from a Service Provider, the SP might not be able to reach all of the UNIs directly within their own network. In this case, they can use an Operator IP Service from another Operator to reach some of the UNIs, as shown in the examples in appendix D.1. Alternatively, the SP could use an Ethernet Service, such as Access E-Line (MEF 51.1 [69]), to link the remote UNI to their network. This is illustrated in the following example.

Figure 71 shows a Subscriber IP Service provided by Org A acting as the SP.



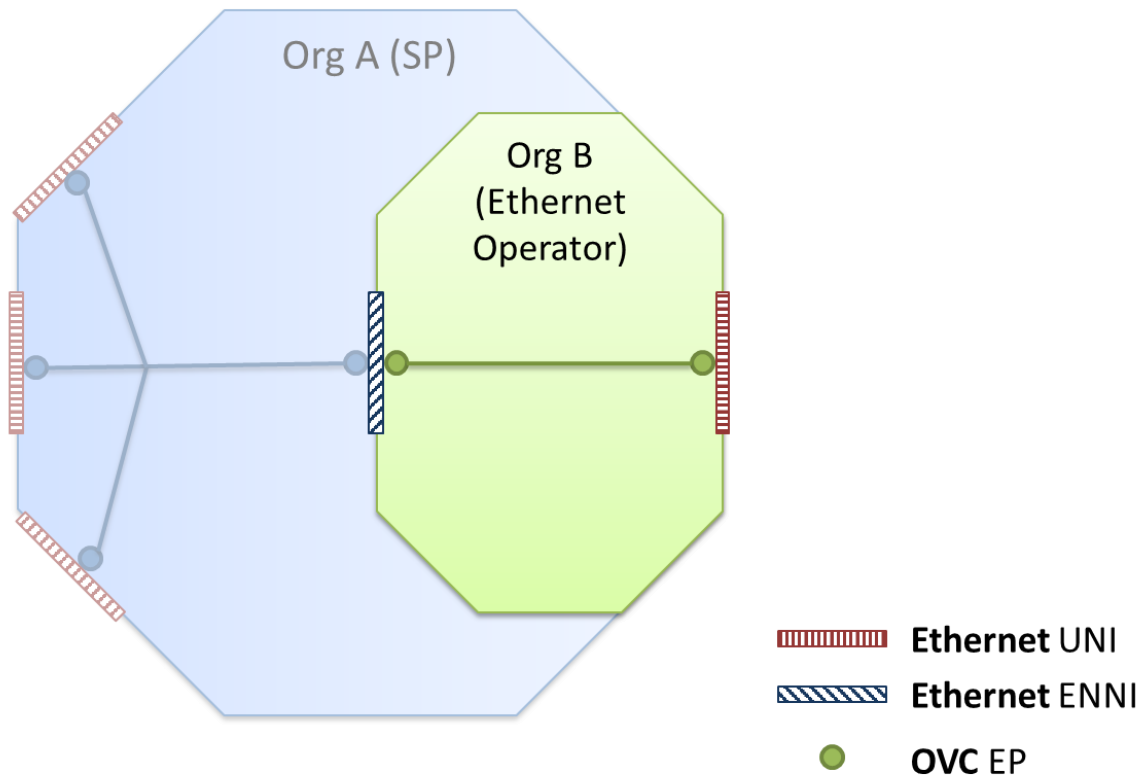
**Figure 71 – Example Subscriber IP Service**

In this example, Org A cannot reach the UNI on the right using their own network, so they use an Access E-Line Ethernet Service from Org B to connect the UNI to their network, as shown in Figure 72. Note that the details of the ENNI and the Ethernet Service are intentionally omitted from this figure.



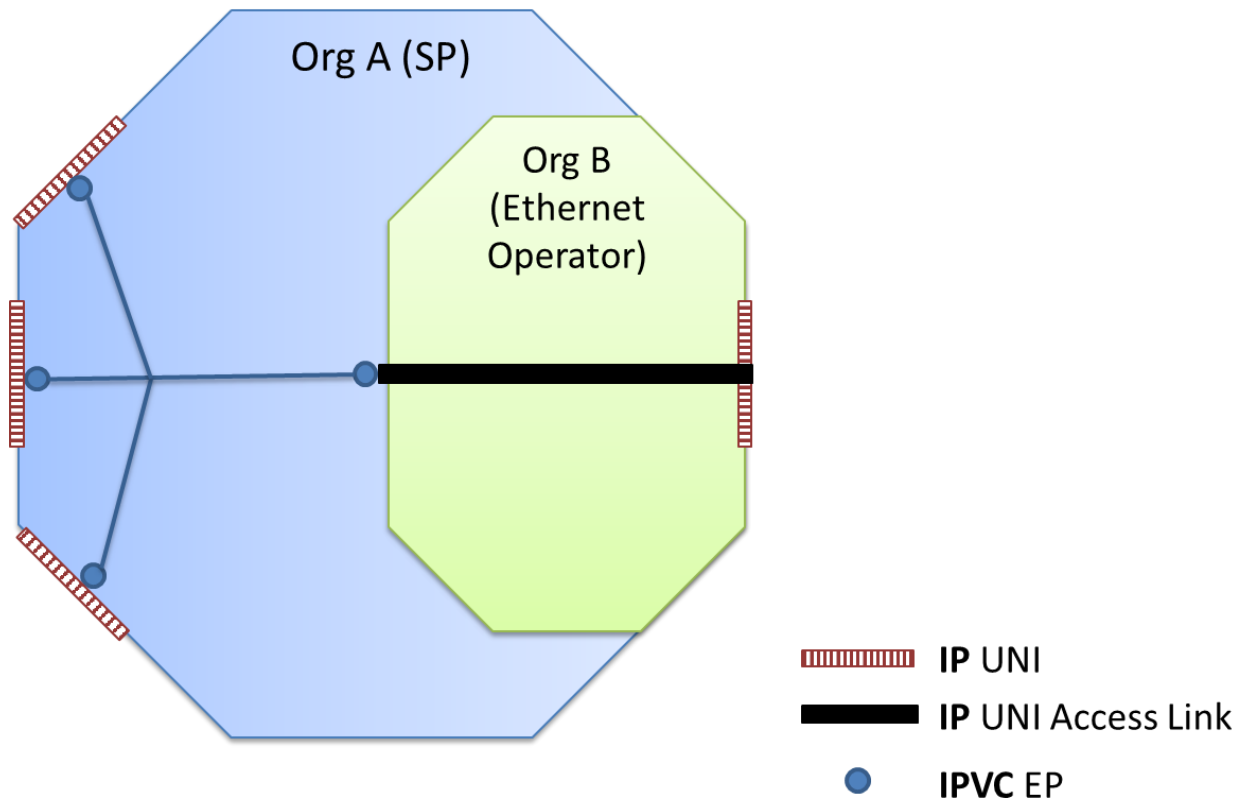
**Figure 72 – Using an Ethernet Service to Connect a Remote UNI**

From the perspective of Org B, they simply provide an Access E-Line service, between an Ethernet UNI and an Ethernet ENNI, as shown in Figure 73. The Ethernet UNI is in the same place as the IP UNI for the Subscriber IP Service.



**Figure 73 – Access E-Line connecting to an IP Service.**

To realize the Subscriber IP Service, the SP (Org A) must map the S-VLAN ID at the Ethernet ENNI to the IP Service within their network. At the IP layer, the entire Access E-Line Service, from the UNI to the Ethernet ENNI, appears as a single IP UNI Access Link, as shown in Figure 74.



**Figure 74 – IP Layer view of the Ethernet Access Service.**

Note that there is no IP ENNI and no Operator IP Services in this example. If the UNI had a Subscriber-Managed CE, the PE would be connected to Org A’s side of the Ethernet ENNI, and would be connected to the CE over a single IP hop traversing the Access E-Line Service.

## Appendix F Implementation Examples for Operator IP Services (Informative)

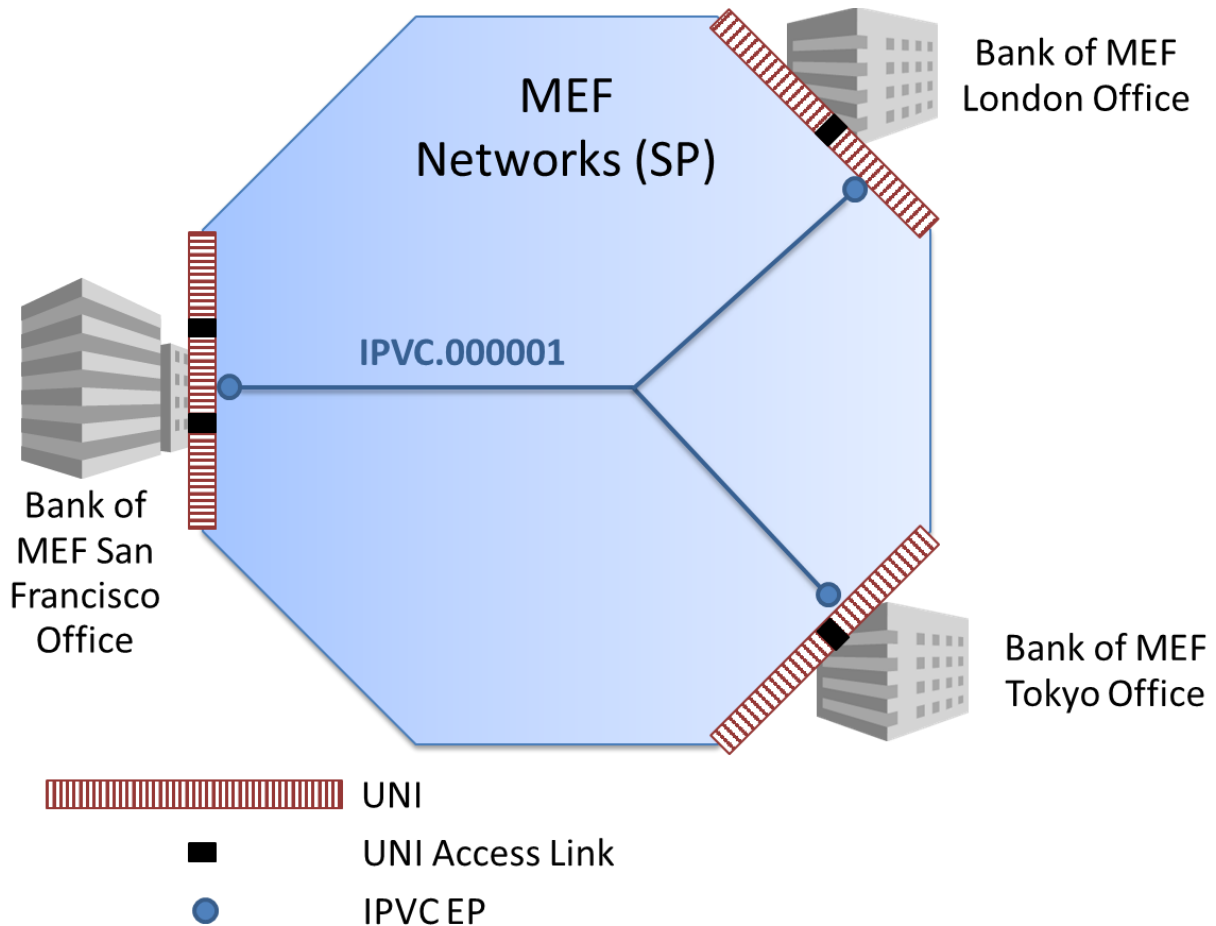
This appendix provides some informative examples showing values for all of the IP Service Attributes applicable to an Operator IP Service, and indicating how they are typically implemented. Note that this specification does not constrain the implementation of IP Services; however, certain implementation approaches are sufficiently common that it is useful to describe how they relate to the Service Attributes described in this document. The examples shown are illustrative and are not intended to indicate particular best practice, or to show how Service Attributes might best be presented.

Note that these examples use IPv4 Documentation Space per RFC 5737 [42], IPv6 Documentation Space per RFC 3849 [27], and Documentation AS Numbers per RFC 5398 [38].

In the following subsections, values that are lists are shown as enclosed in square brackets [], with list entries separated by commas. An empty list is shown as “[ ]”. Values that are sets are shown as enclosed in braces {}, with entries separated by commas. An empty set is shown as “{ }”. Values that are tuples, i.e. that consist of several parameters, are enclosed in parentheses (), with parameter name/value pairs separated by commas.

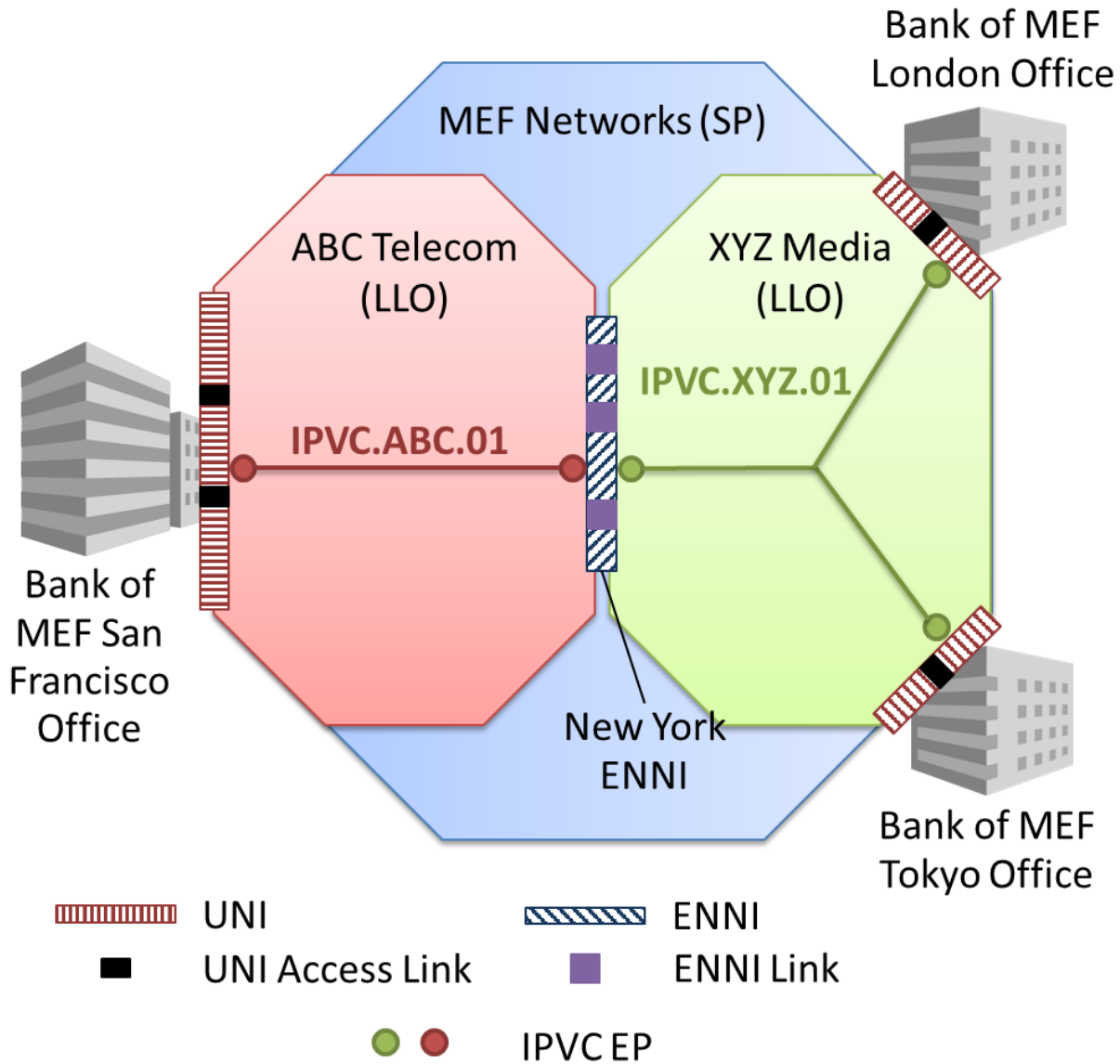
### F.1 Multipoint IPVC Example

Consider the example shown in Appendix C.1, which illustrates multipoint connectivity being provided for *Bank of MEF* between three UNIs by *SP MEF Networks*, as shown in Figure 75.



**Figure 75 – Example Multipoint IP VPN**

Suppose *MEF Networks* implements this service by contracting with two Operators, *ABC Telecom* and *XYZ Media*, who are connected by an ENNI in New York, as shown in Figure 76.



**Figure 76 – Example Operator Services used for a Multipoint IP VPN**

The tables below show the values of all of the attributes used in this scenario. The Identifiers in this example are all arbitrarily chosen; in practice, Service Providers and Operators typically have a standard in place to ensure uniqueness. The IPVCs in this example use standard IP routing with no per site filters or prefix mapping. Documentation space is used throughout the example.

Before *MEF Networks* can order services that connect to the ENNI, the two Operators, *ABC Telecom* and *XYZ Media*, must agree the attributes of the ENNI itself; that is, the ENNI Common Attributes. Table 63 shows the values of the ENNI Common Attributes.

ENNI Common Attribute Name	ENNI Common Attribute Value
ENNI Peering Identifier	ENNI.NYC.ABC-XYZ.0001
ENNI Peering Type	Option A
ENNI List of ENNI Links	[ ( ID: ENNIPhyLink.NYC.ABX-XYZ.0001.01, L1: Ethernet PHY 10GBASE-SR, Links: [ ] ), ( ID: ENNIPhyLink.NYC.ABX-XYZ.0001.02, L1: Ethernet PHY 10GBASE-SR, Links: [ ] ) ]
ENNI List of Control Protocols	[ ( Protocol: BGP, Reference: RFC 4271 ), ( Protocol: BFD, Reference: RFC 5880, RFC 5881 ) ]
ENNI Routing Protocols	[ ( Protocol: BGP, Address Family: Both, First LLO's AS Number: 64496, Second LLO's AS Number: 64497, Connection Address Family: IPv6, Authentication: None, First LLO's BGP Community List: [ ( 64496:1, Route towards a Leaf ) ], First LLO's BGP Extended Community List: [ ], Second LLO's BGP Community List: [ ( 64497:4000, Route towards a Leaf ) ], Second LLO's BGP Extended Community List: [ ], Hold Time: 30s, First LLO's Route Marking for Leaves: Community 64496:1, Second LLO's Route Marking for Leaves: Community 64497:4000 ) ]
ENNI Service Map	[ ]

**Table 63 – ENNI Common Attribute Values**

Note that initially, the list of ENNI Links for each physical link in the ENNI List of ENNI Links is empty, and the ENNI Service Map is also empty. At an ENNI using Option A, as in this case, the individual logical ENNI Links need not be created until a service needs to be carried over them.

Once the ENNI Common Attributes are agreed between the two Operators (*ABC Telecom* and *XYZ Media*) as shown above, the SP (*MEF Networks*) can arrange an Operator IP Service with each of them. Table 64 to Table 70 show the Service Attributes agreed between *MEF Networks* and *ABC Telecom*; Table 71 to Table 79 show the Service Attributes agreed between *MEF Networks* and *XYZ Media*.

Table 64 shows the IPVC Service Attributes for the IPVC agreed between *MEF Networks* and *ABC Telecom*.



IPVC Service Attribute Name	IPVC Service Attribute Value
IPVC Identifier	IPVC.ABC.01
IPVC Topology	Multipoint
IPVC End Point List	[ IPVCEP.ABC.SFO.01.01, IPVCEP.ABC.NYC.01.01 ]
IPVC Packet Delivery	Standard Routing
IPVC Maximum Number of IPv4 Routes	400
IPVC Maximum Number of IPv6 Routes	0
IPVC DSCP Preservation	Enabled
IPVC List of Class of Service Names	[ BestEffort ]
IPVC Service Level Specification	None
IPVC MTU	1500
IPVC Path MTU Discovery	Enabled
IPVC Fragmentation	Enabled
IPVC Cloud	None
IPVC Reserved Prefixes	[ ]

**Table 64 – Example of Subscriber IPVC Service Attributes for a Multipoint IP VPN**

Note that apart from the IPVC Identifier and the IPVC End Point List, most of the IPVC Service Attributes shown in Table 64 for the IPVC provided by *ABC Telecom* to *MEF Networks* have the same values as shown in Table 44 for the IPVC that *MEF Networks* has agreed with the Subscriber. A notable difference is the SLS: since the SLS agreed with the Subscriber (per Table 44) did not include any performance objectives applicable to the San Francisco office, the SP (*MEF Networks*) has agreed that no SLS is needed for the IPVC provided by *ABC Telecom* that connects the San Francisco office to the rest of the Subscriber’s network via the ENNI in New York. Another difference is that although both IPVCs have a single CoS Name, the CoS Name used by *ABC Telecom* to describe their service to *MEF Networks* (“BestEffort”) is different to the CoS Name used by *MEF Networks* to describe their service to the Subscriber (“Basic”).

The next four tables show the Service Attributes agreed between the SP (*MEF Networks*) and the Operator (*ABC Telecom*) at the San Francisco UNI. The San Francisco UNI has two UNI Access Links. Table 65 shows the values of the UNI Service Attributes for the San Francisco UNI.

UNI Service Attribute Name	UNI Service Attribute Value
UNI Identifier	UNI.ABC.SFO.01
UNI Management Type	Subscriber-Managed
UNI List of UNI Access Links	[ UNIAL.ABC.SFO.01.01, UNIAL.ABC.SFO.01.02 ]
UNI Ingress Bandwidth Profile Envelope	None
UNI Egress Bandwidth Profile Envelope	None

UNI Service Attribute Name	UNI Service Attribute Value
UNI List of Control Protocols	[ ( Protocol: BGP, Addressing: Operator Addresses, Reference: RFC 4271 ), ( Protocol: BFD, Addressing: Any, Reference: RFC 5880 and RFC 5881 ) ]
UNI Routing Protocols	[ ( Protocol: BGP, Address Family: IPv4, Subscriber's AS Number: 65536, Operator's AS Number: 64496, Connection Address Family: IPv4, Peering Addresses: Connection Addresses, Authentication: None, BGP Community List: [ ( 64496:90, Set Local Preference to 90 ), ( 64496:120, Set Local Preference to 120 ) ], BGP Extended Community List: [ ], Hold Time: 90, Damping: None, AS Override: Disabled Administrative Distance: 80 ) ]
UNI Reverse Path Forwarding	Enabled

**Table 65 – Example of UNI Service Attributes for the San Francisco UNI**

Note that apart from the UNI Identifier and the UNI List of UNI Access Links, most of the UNI Service Attributes have the same values agreed between *ABC Telecom* and *MEF Networks* (shown in Table 65) as *MEF Networks* has agreed with the Subscriber (shown in Table 51). One difference is that ICMP is not included in the UNI List of Control Protocols in Table 65. This means ICMP packets are carried transparently over *ABC Telecom's* network; however, they could still be peered after crossing the ENNI.

Table 66 and Table 67 show the values of the UNI Access Link Service Attributes agreed between the SP (*MEF Networks*) and the Operator (*ABC Telecom*) for the two UNI Access Links in the San Francisco UNI.

UNI Access Link Service Attribute Name	UNI Access Link Service Attribute Value
UNI Access Link Identifier	UNIAL.ABC.SFO.01.01
UNI Access Link Connection Type	P2P
UNI Access Link L2 Technology	Ethernet, no C-tag, no S-tag, 1000 Base-T with Autonegotiation

UNI Access Link Service Attribute Name	UNI Access Link Service Attribute Value
UNI Access Link IPv4 Connection Addressing	( Type: Static, Primary IPv4 Prefix: 203.0.113.34/31, Primary Operator IPv4 Addresses: [203.0.113.34], Primary Subscriber IPv4 Address: 203.0.113.35, Primary Reserved Prefixes: [ ], Secondary Subnets: [ ] )
UNI Access Link IPv6 Connection Addressing	None
UNI Access Link DHCP Relay	Disabled
UNI Access Link BFD	( Connection Address Family: IPv4, Transmission Interval: 100, Detect Multiplier: 3, Active End: Subscriber, Authentication Type: None )
UNI Access Link IP MTU	1500
UNI Access Link Ingress Bandwidth Profile Envelope	None
UNI Access Link Egress Bandwidth Profile Envelope	None
UNI Access Link Reserved VRIDs	[ ]

**Table 66 – Example of UNI Access Link Service Attributes for the San Francisco UNI (Link 1)**

UNI Access Link Service Attribute Name	UNI Access Link Service Attribute Value
UNI Access Link Identifier	UNIAL.ABC.SFO.01.02
UNI Access Link Connection Type	P2P
UNI Access Link L2 Technology	Ethernet, C-tag with VID 100, no S-tag, 1000 Base-SX with Autonegotiation
UNI Access Link IPv4 Connection Addressing	( Type: Static, Primary IPv4 Prefix: 203.0.113.36/31, Primary Operator IPv4 Addresses: [203.0.113.36], Primary Subscriber IPv4 Address: 203.0.113.37, Primary Reserved Prefixes: [ ], Secondary Subnets: [ ] )
UNI Access Link IPv6 Connection Addressing	None
UNI Access Link DHCP Relay	Disabled

UNI Access Link Service Attribute Name	UNI Access Link Service Attribute Value
UNI Access Link BFD	( Connection Address Family: IPv4, Transmission Interval: 100, Detect Multiplier: 3, Active End: Subscriber, Authentication Type: None )
UNI Access Link IP MTU	1500
UNI Access Link Ingress Bandwidth Profile Envelope	None
UNI Access Link Egress Bandwidth Profile Envelope	None
UNI Access Link Reserved VRIDs	[ ]

**Table 67 – Example of UNI Access Link Service Attributes for the San Francisco UNI (Link 2)**

Note that apart from the UNI Access Link Identifier, the UNI Access Link Service Attributes have the same values agreed between *ABC Telecom* and *MEF Networks* (shown in Table 66 and Table 67) as *MEF Networks* has agreed with the Subscriber (shown in Table 52 and Table 53).

Table 68 shows the values of the IPVC EP Service Attributes agreed between the SP (*MEF Networks*) and the Operator (*ABC Telecom*) for the IPVC EP at the San Francisco UNI.

IPVC EP Service Attribute Name	IPVC EP Service Attribute Value
IPVC EP Identifier	IPVCEP.ABC.SFO.01.01
IPVC EP EI Type	UNI
IPVC EP EI	UNI.ABC.SFO.01
IPVC EP Role	Root
IPVC EP Prefix Mapping	[ ]
IPVC EP Maximum Number of IPv4 Routes	300
IPVC EP Maximum Number of IPv6 Routes	0
IPVC EP Ingress Class of Service Map	( F: IP DS, M: [ ], D: BestEffort )
IPVC EP Egress Class of Service Map	N/A
IPVC EP Ingress Bandwidth Profile Envelope	None
IPVC EP Egress Bandwidth Profile Envelope	None

**Table 68 – Example of IPVC EP Service Attributes at the San Francisco UNI**

Note that apart from the IPVC EP Identifier, the IPVC EP EI, and the CoS Name in the IPVC EP Ingress Class of Service Map, the IPVC EP Service Attributes have the same values agreed between *ABC Telecom* and *MEF Networks* (shown in Table 68) as *MEF Networks* has agreed with the Subscriber (shown in Table 54). Note also that there is an additional attribute, the IPVC EP

EI Type, shown in Table 68. This is needed because for an Operator service, it needs to be agreed whether the IPVC EP is at a UNI or an ENNI.

The next two tables show the Service Attributes agreed between the SP (*MEF Networks*) and the Operator (*ABC Telecom*) at the ENNI. Table 69 shows the values of the ENNI Service Attributes for the ENNI.

ENNI Service Attribute Name	ENNI Service Attribute Value
ENNI Identifier	ENNI.ABC.NYC.01
ENNI Type	Option A
ENNI Routing Information	[ IPVC.000001 → ( Administrative Distance: 90, Route Flap Damping: Disabled, AS Override: Disabled, Static Routes: [] ) ]
ENNI Ingress Bandwidth Profile Envelopes	None
ENNI Egress Bandwidth Profile Envelopes	None

**Table 69 – Example of ENNI Service Attributes**

Note that the identifier that *ABC Telecom* uses to identify the ENNI to *MEF Networks* (as shown in Table 69) is different to the identifier *ABC Telecom* uses to identify the ENNI to the peer Operator, *XYZ Media* (as shown in Table 63). It is *ABC Telecom*'s responsibility to map these identifier to the same underlying ENNI.

Table 70 shows the values of the IPVC EP Service Attributes agreed between the SP (*MEF Networks*) and the Operator (*ABC Telecom*) for the IPVC EP at the ENNI.

IPVC EP Service Attribute Name	IPVC EP Service Attribute Value
IPVC EP Identifier	IPVCEP.ABC.NYC.01.01
IPVC EP EI Type	ENNI
IPVC EP EI	ENNI.ABC.NYC.01
IPVC EP Role	Root
IPVC EP Prefix Mapping	[ ]
IPVC EP ENNI Service Mapping Identifier	IPVC.000001
IPVC EP Maximum Number of IPv4 Routes	150
IPVC EP Maximum Number of IPv6 Routes	0
IPVC EP Ingress Class of Service Map	( F: IP DS, M: [ ], D: BestEffort )
IPVC EP Egress Class of Service Map	N/A
IPVC EP Ingress Bandwidth Profile Envelope	None
IPVC EP Egress Bandwidth Profile Envelope	None

**Table 70 – Example of IPVC EP Service Attributes at the ENNI**

Note that compared to the IPVC EP at the UNI (shown in Table 68), there is one additional attribute: the ENNI Service Mapping Identifier, which is used to match this IPVC EP with the corresponding one on the other side of the ENNI. The SP, *MEF Networks*, has chosen to use the ID for the IPVC they are providing to the Subscriber (see Table 44) as the ENNI Service Mapping Identifier. Note also that the maximum number of routes for this IPVC EP reflects the number that are expected to be learned over the ENNI, which corresponds to the routes towards the remote UNIs (i.e. it corresponds to the maximum number that applies at the UNIs in London and Tokyo, see Table 47 and Table 50).

Table 64 to Table 70 above showed the Service Attributes agreed between *MEF Networks* and one of the Operators, *ABC Telecom*; Table 71 to Table 79 below show the Service Attributes agreed between *MEF Networks* and the other Operator, *XYZ Media*.

Table 71 shows the IPVC Service Attributes for the IPVC agreed between *MEF Networks* and *XYZ Media*.

IPVC Service Attribute Name	IPVC Service Attribute Value
IPVC Identifier	IPVC.XYZ.01
IPVC Topology	Multipoint
IPVC End Point List	[ IPVCEP.XYZ.LONDON.01.01, IPVCEP.XYZ.TOKYO.01.01 IPVCEP.XYZ.NYC.01.01 ]
IPVC Packet Delivery	Standard Routing
IPVC Maximum Number of IPv4 Routes	400
IPVC Maximum Number of IPv6 Routes	0
IPVC DSCP Preservation	Enabled
IPVC List of Class of Service Names	[ Single ]
IPVC Service Level Specification	( s: 00:00:00 on 1 July 2017, T: 1 Calendar Month, E: { ( Metric: One-way Packet Loss Ratio, C: Basic, S: {(IPVCEP.XYZ.TOKYO.01.01, London), (London, IPVCEP.XYZ.TOKYO.01.01)}, F̂: 0.1% )}, L: { ( Name: London, Description: London Docklands IPVC EPs: [ IPVCEP.XYZ.LONDON.01.01 ] )} )
IPVC MTU	1500
IPVC Path MTU Discovery	Enabled
IPVC Fragmentation	Enabled

IPVC Service Attribute Name	IPVC Service Attribute Value
IPVC Cloud	None
IPVC Reserved Prefixes	[ 203.0.113.0/27 ]

**Table 71 – Example of Subscriber IPVC Service Attributes for a Multipoint IP VPN**

Note that apart from the IPVC Identifier and the IPVC End Point List, most of the IPVC Service Attributes shown in Table 71 for the IPVC provided by *XYZ Media* to *MEF Networks* have the same values as shown in Table 44 for the IPVC that *MEF Networks* has agreed with the Subscriber, and as shown in Table 64 for the IPVC provided by *ABC Telecom* to *MEF Networks*. In the case of the IPVC provided by *XYZ Media* to *MEF Networks* (Table 71), the SLS has been agreed so as to match the SLS that *MEF Networks* agreed with the Subscriber (Table 44). Although all the IPVCs have a single CoS Name, the CoS Name used by *XYZ Media* to describe their service to *MEF Networks* (“Single”) is different to the CoS Name used by *MEF Networks* to describe their service to the Subscriber (“Basic”) and to the CoS Name used by *ABC Telecom* (“BestEffort”).

The next three tables show the Service Attributes agreed between the SP (*MEF Networks*) and the Operator (*XYZ Media*) at the London UNI. The London UNI has a single UNI Access Link. Table 72 shows the values of the UNI Service Attributes for the London UNI.

UNI Service Attribute Name	UNI Service Attribute Value
UNI Identifier	UNI.XYZ.LON.01
UNI Management Type	Subscriber-Managed
UNI List of UNI Access Links	[ UNIAL.XYZ.LON.01.01 ]
UNI Ingress Bandwidth Profile Envelope	None
UNI Egress Bandwidth Profile Envelope	None
UNI List of Control Protocols	[ ( Protocol: ICMP, Addressing: SP Addresses, Reference: RFC 792 ), ( Protocol: OSPF, Addressing: Any Reference: RFC 2328 ) ]
UNI Routing Protocols	[ ( Protocol: OSPF, Address Family: IPv4, Area ID: 100.100.100.1, Area Type: Normal, Authentication Type: Message Digest, Hello Interval: 10, Dead Interval: 40, Retransmit Interval: 5, Administrative Distance: 50 ) ]
UNI Reverse Path Forwarding	Enabled

**Table 72 – Example of UNI Service Attributes for the London UNI**

Note that apart from the UNI Identifier and the UNI List of UNI Access Links, all of the UNI Service Attributes have the same values agreed between *XYZ Media* and *MEF Networks* (shown in Table 72) as *MEF Networks* has agreed with the Subscriber (shown in Table 45).

Table 73 shows the values of the UNI Access Link Service Attributes agreed between the SP (*MEF Networks*) and the Operator (*XYZ Media*) for the UNI Access Link in the London UNI.

UNI Access Link Service Attribute Name	UNI Access Link Service Attribute Value
UNI Access Link Identifier	UNIAL.XYZ.LON.01.01
UNI Access Link Connection Type	P2P
UNI Access Link L2 Technology	Ethernet, no C-tag, no S-tag, 1000 Base-T with Autonegotiation
UNI Access Link IPv4 Connection Addressing	( Type: Static, Primary IPv4 Prefix: 203.0.113.32/31, Primary Operator IPv4 Addresses: [203.0.113.32], Primary Subscriber IPv4 Address: 203.0.113.33, Primary Reserved Prefixes: [ ], Secondary Subnets: [ ] )
UNI Access Link IPv6 Connection Addressing	None
UNI Access Link DHCP Relay	Disabled
UNI Access Link BFD	None
UNI Access Link IP MTU	1500
UNI Access Link Ingress Bandwidth Profile Envelope	None
UNI Access Link Egress Bandwidth Profile Envelope	None
UNI Access Link Reserved VRIDs	[ ]

**Table 73 – Example of UNI Access Link Service Attributes for the London UNI**

Note that apart from the UNI Access Link Identifier, the UNI Access Link Service Attributes have the same values agreed between *XYZ Telecom* and *MEF Networks* (shown in Table 73) as *MEF Networks* has agreed with the Subscriber (shown in Table 46).

Table 74 shows the values of the IPVC EP Service Attributes agreed between the SP (*MEF Networks*) and the Operator (*XYZ Media*) for the IPVC EP at the London UNI.

IPVC EP Service Attribute Name	IPVC EP Service Attribute Value
IPVC EP Identifier	IPVCEP.XYZ.LONDON.01.01
IPVC EP EI Type	UNI
IPVC EP EI	UNI.XYZ.LON.01
IPVC EP Role	Root
IPVC EP Prefix Mapping	[ ]
IPVC EP Maximum Number of IPv4 Routes	150
IPVC EP Maximum Number of IPv6 Routes	0
IPVC EP Ingress Class of Service Map	( F: IP DS, M: [ ], D: Single )



IPVC EP Service Attribute Name	IPVC EP Service Attribute Value
IPVC EP Egress Class of Service Map	N/A
IPVC EP Ingress Bandwidth Profile Envelope	None
IPVC EP Egress Bandwidth Profile Envelope	None

**Table 74 – Example of IPVC EP Service Attributes at the London UNI**

Note that apart from the IPVC EP Identifier, the IPVC EP EI, and the CoS Name in the IPVC EP Ingress Class of Service Map, the IPVC EP Service Attributes have the same values agreed between *XYZ Media* and *MEF Networks* (shown in Table 74) as *MEF Networks* has agreed with the Subscriber (shown in Table 47).

The next three tables show the Service Attributes agreed between the SP (*MEF Networks*) and the Operator (*XYZ Media*) at the Tokyo UNI. The Tokyo UNI has a single UNI Access Link. Table 75 shows the values of the UNI Service Attributes for the Tokyo UNI.

UNI Service Attribute Name	UNI Service Attribute Value
UNI Identifier	UNI.XYZ.TKO.01
UNI Management Type	Provider-Managed
UNI List of UNI Access Links	[ UNIAL.XYZ.TKO.01.01 ]
UNI Ingress Bandwidth Profile Envelope	None
UNI Egress Bandwidth Profile Envelope	None
UNI List of Control Protocols	[ ( Protocol: ICMP, Addressing: SP Addresses, Reference: RFC 792 ) ]
UNI Routing Protocols	[ ]
UNI Reverse Path Forwarding	Enabled

**Table 75 – Example of UNI Service Attributes for the Tokyo UNI**

Note that apart from the UNI Identifier and the UNI List of UNI Access Links, all of the UNI Service Attributes have the same values agreed between *XYZ Media* and *MEF Networks* (shown in Table 75) as *MEF Networks* has agreed with the Subscriber (shown in Table 48).

Table 76 shows the values of the UNI Access Link Service Attributes agreed between the SP (*MEF Networks*) and the Operator (*XYZ Media*) for the UNI Access Link in the Tokyo UNI.

UNI Access Link Service Attribute Name	UNI Access Link Service Attribute Value
UNI Access Link Identifier	UNIAL.XYZ.TKO.01.01
UNI Access Link Connection Type	Multipoint
UNI Access Link L2 Technology	Ethernet, no C-tag, no S-tag, 1000 Base-T with Autonegotiation

UNI Access Link Service Attribute Name	UNI Access Link Service Attribute Value
UNI Access Link IPv4 Connection Addressing	( Type: Static, Primary IPv4 Prefix: 203.0.113.192/26, Primary Operator IPv4 Addresses: [203.0.113.193], Primary Subscriber IPv4 Address: Not Specified, Primary Reserved Prefixes: [ ], Secondary Subnets: [ ] )
UNI Access Link IPv6 Connection Addressing	None
UNI Access Link DHCP Relay	Disabled
UNI Access Link BFD	None
UNI Access Link IP MTU	1500
UNI Access Link Ingress Bandwidth Profile Envelope	None
UNI Access Link Egress Bandwidth Profile Envelope	None
UNI Access Link Reserved VRIDs	[ ]

**Table 76 – Example of UNI Access Link Service Attributes for the Tokyo UNI**

Note that apart from the UNI Access Link Identifier, the UNI Access Link Service Attributes have the same values agreed between *XYZ Telecom* and *MEF Networks* (shown in Table 76) as *MEF Networks* has agreed with the Subscriber (shown in Table 49).

Table 77 shows the values of the IPVC EP Service Attributes agreed between the SP (*MEF Networks*) and the Operator (*XYZ Media*) for the IPVC EP at the Tokyo UNI.

IPVC EP Service Attribute Name	IPVC EP Service Attribute Value
IPVC EP Identifier	IPVCEP.XYZ.TOKYO.01.01
IPVC EP EI Type	UNI
IPVC EP EI	UNI.XYZ.TKO.01
IPVC EP Role	Root
IPVC EP Prefix Mapping	[ ]
IPVC EP Maximum Number of IPv4 Routes	1
IPVC EP Maximum Number of IPv6 Routes	0
IPVC EP Ingress Class of Service Map	( F: IP DS, M: [ ], D: Single )
IPVC EP Egress Class of Service Map	N/A
IPVC EP Ingress Bandwidth Profile Envelope	None
IPVC EP Egress Bandwidth Profile Envelope	None

**Table 77 – Example of IPVC EP Service Attributes at the Tokyo UNI**

Note that apart from the IPVC EP Identifier, the IPVC EP EI, and the CoS Name in the IPVC EP Ingress Class of Service Map, the IPVC EP Service Attributes have the same values agreed between *XYZ Media* and *MEF Networks* (shown in Table 77) as *MEF Networks* has agreed with the Subscriber (shown in Table 50).

The final two tables show the Service Attributes agreed between the SP (*MEF Networks*) and the Operator (*XYZ Media*) at the ENNI. Table 78 shows the values of the ENNI Service Attributes for the ENNI.

ENNI Service Attribute Name	ENNI Service Attribute Value
ENNI Identifier	ENNI.XYZ.NYC.01
ENNI Type	Option A
ENNI Routing Information	[ IPVC.000001 → ( Administrative Distance: 90, Route Flap Damping: Disabled, AS Override: Disabled, Static Routes: [ ] ) ]
ENNI Ingress Bandwidth Profile Envelopes	None
ENNI Egress Bandwidth Profile Envelopes	None

**Table 78 – Example of ENNI Service Attributes**

Note that the identifier that *XYZ Media* uses to identify the ENNI to *MEF Networks* (as shown in Table 78) is different to the identifier *XYZ Media* uses to identify the ENNI to the peer Operator, *ABC Telecom* (as shown in Table 63). It is *XYZ Media*'s responsibility to map these identifier to the same underlying ENNI.

Table 79 shows the values of the IPVC EP Service Attributes agreed between the SP (*MEF Networks*) and the Operator (*XYZ Media*) for the IPVC EP at the ENNI.

IPVC EP Service Attribute Name	IPVC EP Service Attribute Value
IPVC EP Identifier	IPVCEP.XYZ.NYC.01.01
IPVC EP EI Type	ENNI
IPVC EP EI	ENNI.XYZ.NYC.01
IPVC EP Role	Root
IPVC EP Prefix Mapping	[ ]
IPVC EP ENNI Service Mapping Identifier	IPVC.000001
IPVC EP Maximum Number of IPv4 Routes	300
IPVC EP Maximum Number of IPv6 Routes	0
IPVC EP Ingress Class of Service Map	( F: IP DS, M: [ ], D: Single )
IPVC EP Egress Class of Service Map	N/A
IPVC EP Ingress Bandwidth Profile Envelope	None
IPVC EP Egress Bandwidth Profile Envelope	None

**Table 79 – Example of IPVC EP Service Attributes at the ENNI**

Note that compared to the IPVC EPs at the UNIs (shown in Table 74 and Table 77), there is one additional attribute: the ENNI Service Mapping Identifier, which is used to match this IPVC EP with the corresponding one on the other side of the ENNI. The SP, *MEF Networks*, agrees the same ENNI Service Mapping Identifier for the IPVC EP at the ENNI with *XYZ Media* as they agreed with *ABC Telecom* (as shown in Table 70). Note again that the maximum number of routes for this IPVC EP reflects the number that are expected to be learned over the ENNI, which corresponds to the routes towards remote UNIs (i.e. it corresponds to the maximum number that applies at the UNI in San Francisco, see Table 54).

The final step necessary to complete the setup of the service is for the two Operators, *ABC Telecom* and *XYZ Networks*, to agree a set of ENNI Links to carry the service over the ENNI, along with a new value of the ENNI Service Map Common Attribute shown in Table 63, to map the ENNI Service Mapping Identifier for the IPVC EPs at the ENNI (“IPVC.000001” as shown in Table 70 and Table 79) to those of ENNI Links. In this example the LLOs agree to map the ENNI Service Mapping Identifier to two physically disparate ENNI Links, i.e. one ENNI Link over each of the physical links that form the ENNI.

Table 80 and Table 81 show the values of the ENNI Link Attributes that are agreed between the two Operators, *ABC Telecom* and *XYZ Networks*, for the two ENNI Links.

ENNI Link Attribute Name	ENNI Link Attribute Value
ENNI Link Identifier	ENNILink.NYC.ABX-XYZ.01.01
ENNI Link L2 Technology	Ethernet, VLAN Tagged with C-VID 101
ENNI Link IPv4 Connection Addressing	Static: ( Primary Subnet: ( IPv4 Prefix: 198.51.100.64/31, First LLO IPv4 Address: 198.51.100.64, Second LLO IPv4 Address: 198.51.100.65 ), Secondary Subnet List: [ ] )
ENNI Link IPv6 Connection Addressing	Static: [ ( IPv6 Prefix: 2001:DB8:1:1::/64, First LLO IPv6 Address: 2001:DB8:1:1::1, Second LLO Ipv6 Address: 2001:DB8:1:1::2) ]
ENNI Link BFD	( Connection Address Family: IPv6, Transmission Interval: 50ms, Detect Multiplier: 3, Authentication Type: None )
ENNI Link IP MTU	1500

**Table 80 – ENNI Link Attribute Values for ENNI Link 1**

ENNI Link Attribute Name	ENNI Link Attribute Value
ENNI Link Identifier	ENNILink.NYC.ABX-XYZ.01.02
ENNI Link L2 Technology	Ethernet, VLAN Tagged with C-VID 101
ENNI Link IPv4 Connection Addressing	Static: ( Primary Subnet: ( IPv4 Prefix: 198.51.100.66/31, First LLO IPv4 Address: 198.51.100.66, Second LLO IPv4 Address: 198.51.100.67 ), Secondary Subnet List: [ ] )
ENNI Link IPv6 Connection Addressing	Static: [ ( IPv6 Prefix: 2001:DB8:1:2::/64, First LLO IPv6 Address: 2001:DB8:1:2::1, Second LLO Ipv6 Address: 2001:DB8:1:2::2 ) ]
ENNI Link BFD	( Connection Address Family: IPv6, Transmission Interval: 50ms, Detect Multiplier: 3, Authentication Type: None )
ENNI Link IP MTU	1500

**Table 81 – ENNI Link Attribute Values for ENNI Link 2**

It can be seen that both ENNI Links are carried over a specific VLAN. The ENNI Links are mapped to different physical links by agreeing a new value of the ENNI List of ENNI Links Common Attribute, as shown in Table 82.

Finally, the service needs to be mapped to these ENNI Links by agreeing a new value of the ENNI Service Map Common Attribute as shown in Table 82. The value agreed between *ABC Telecom* and *XYZ Networks* identifies that the two ENNI Links created above are used to carry *MEF Network's* service.

ENNI Common Attribute Name	ENNI Common Attribute Value
ENNI List of ENNI Links	[ ( ID: ENNIPhyLink.NYC.ABX-XYZ.0001.01, L1: Ethernet PHY 10GBASE-SR, Links: [ ENNILink.NYC.ABX-XYZ.01.01 ] ), ( ID: ENNIPhyLink.NYC.ABX-XYZ.0001.02, L1: Ethernet PHY 10GBASE-SR, Links: [ ENNILink.NYC.ABX-XYZ.01.02 ] ) ]
ENNI Service Map	[ (MEF Networks, IPVC.000001) → { ENNILink.NYC.ABX-XYZ.01.01, ENNILink.NYC.ABX-XYZ.01.02 } ]

**Table 82 – New ENNI Common Attribute Values**

Note that the lists of links in the ENNI List of ENNI Links are no longer empty. Note also that the value of the ENNI Service Map Common Attribute actually maps an ENNI Service Mapping

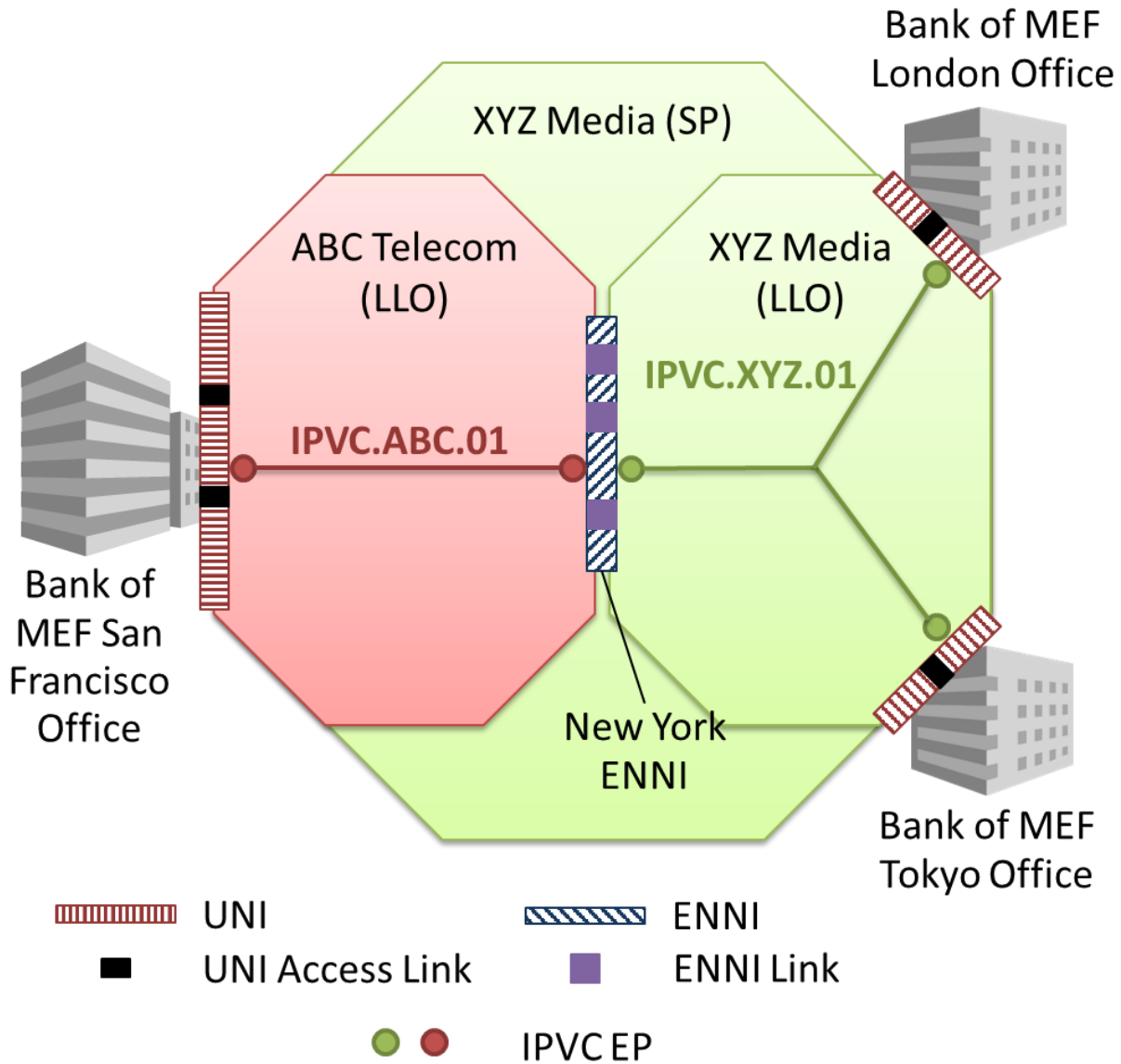
Context – i.e. a pair of (SP/IO name, ENNI Service Mapping Identifier) – to the set of ENNI Links. The addition of the SP/IO name is necessary as there could be other SPs also using this ENNI.

Table 83 summarizes all the attributes used in this example.

Attributes	Location	Service	Table	
IPVC Service Attributes	London	Subscriber IP Service agreed between SP <i>MEF Networks</i> and Subscriber <i>Bank of MEF</i> .	Table 44	
UNI Service Attributes			Table 45	
UNI Access Link Service Attributes			Table 46	
IPVC EP Service Attributes			Table 47	
UNI Service Attributes	Tokyo		Table 48	
UNI Access Link Service Attributes			Table 49	
IPVC EP Service Attributes			Table 50	
UNI Service Attributes	San Francisco		Table 51	
UNI Access Link Service Attributes			Table 52	
UNI Access Link Service Attributes			Table 53	
IPVC EP Service Attributes			Table 54	
ENNI Common Attributes	New York		ENNI agreed between Operator <i>ABC Telecom</i> and Operator <i>XYZ Media</i> .	Table 63 / Table 82
ENNI Link Attributes				Table 80
ENNI Link Attributes				Table 81
IPVC Service Attributes	San Francisco	Operator IP Service agreed between SP <i>MEF Networks</i> and Operator <i>ABC Telecom</i> .	Table 64	
UNI Service Attributes			Table 65	
UNI Access Link Service Attributes			Table 66	
UNI Access Link Service Attributes			Table 67	
IPVC EP Service Attributes			Table 68	
ENNI Service Attributes	New York		Table 69	
IPVC EP Service Attributes			Table 70	
IPVC Service Attributes	London		Operator IP Service agreed between SP <i>MEF Networks</i> and Operator <i>XYZ Media</i> .	Table 71
UNI Service Attributes				Table 72
UNI Access Link Service Attributes				Table 73
IPVC EP Service Attributes		Table 74		
UNI Service Attributes	Tokyo	Table 75		
UNI Access Link Service Attributes		Table 76		
IPVC EP Service Attributes		Table 77		
ENNI Service Attributes	New York	Table 78		
IPVC EP Service Attributes		Table 79		

**Table 83 – Summary of Attributes used in the Example**

The example described in this section shows a case where the SP does not operate either of the networks that are actually used to implement the Subscriber service. A common case is where the SP is actually one of the Operators. Consider the example above, but where the SP is *XYZ Media* not *MEF Networks*, as shown in Figure 77.



**Figure 77 – Example Operator Services used for a Multipoint IP VPN**

The differences would be:

- The Service Attributes for the Subscriber IP Service (Table 44 – Table 54) would be agreed between *XYZ Media* (acting as the SP) and the Subscriber.
- The Service Attributes for the Operator IP Service provided by *ABC Telecom* (Table 64 – Table 70) would be agreed with *XYZ Media* (acting as the SP).
- The final set of Service Attributes (Table 71 – Table 79) would not be needed; logically these are agreed between *XYZ Media* (acting as the SP) and themselves (acting as an Operator), but it is an internal matter for that organization as to whether this is done in practice.

Note that in this case, both the Common Attributes for the ENNI and its ENNI Links (Table 63 and Table 80 – Table 81) and the Service Attributes for the Operator Service provided by *ABC Telecom* (Table 64 – Table 70) are agreed between the same pair of organizations, i.e. between *ABC Telecom* and *XYZ Media*.



## Appendix G Changes from MEF 61

The following changes have been made in this document compared with MEF 61, to accommodate the addition of Service Attributes for Operator IP Services:

- Title of the document changed to “IP Service Attributes”.
- “Super Operator” (SO), “Lowest Level Operator” (LLO), “Operator Network”, “ENNI Service Mapping Identifier” and “ENNI Service Mapping Context” added to the Terminology Table.
- Section 7.9, revised and clarified the description of Internet Access.
- Section 8, Key Concepts for Operator IP Services, added to describe Operator IP Services, ENNIs, ENNI Links, Common Attributes, Super Operators and Lowest Level Operators, and how services are connected across an ENNI.
- Section 9 updated to describe routing information databases at an ENNI, how routes are advertised over an ENNI, and selection of an IPVC EP for ingress IP Packets at an ENNI.
- Moved the section on IP Data Packet Transparency from a sub-section of section 10.4 to be section 9.4.
- Section 10 renamed and the introductory text updated, to clarify that IPVC Service Attributes apply to both Subscriber and Operator IP Services.
- Additional requirements relating to Packet Delivery for ENNIs and Operator IP Services added in section 10.3 and 11.5.
- Definition of the SLS revised to allow other Performance Metrics, in section 10.9.
- Definition of SLS Reference Points clarified in the case of an ENNI, in section 10.9.1.
- Section 11 renamed and the introductory text updated, to clarify that IPVC EP Service Attributes apply to both Subscriber and Operator IP Services.
- Added new IPVC EP Service Attributes for Operator IPVC EPs: IPVC EP EI Type (11.2), IPVC EP ENNI Service Mapping Identifier (11.6).
- Renamed the IPVC EP UNI Service Attribute to IPVC EP EI Service Attribute (11.3).
- Updated the IPVC EP Role Service Attribute (11.4) to add a trunk role at the ENNI and describe how a rooted multipoint IPVC can be implemented across an ENNI.
- Added details for the IPVC EP Egress Class of Service Map Service Attribute (section 11.10).
- Section 12 renamed and the introductory text updated, to clarify that UNI Service Attributes apply to both Subscriber and Operator IP Services.
- Updated BGP Parameters and requirements in section 12.7.3 to accommodate Operator IP Services.
- Section 13 renamed and the introductory text updated, to clarify that UNI Access Link Service Attributes apply to both Subscriber and Operator IP Services.
- Added section 14 to describe ENNI Service Attributes.
- Added section 15 to describe ENNI Common Attributes.
- Added section 16 to describe ENNI Link Attributes.
- Updated section 17 to describe BWP Envelopes and BWP Flows at an ENNI.
- Updated reference from MEF 51 to MEF 51.1.
- Updated appendix B.5.3 regarding the Egress CoS Map.
- Updated Appendix A to cover Operator IP Services.
- Added Appendix D giving examples for Operator IP Services.

- Added Appendix E describing how an Ethernet Access Service can be used to help implement an IP Service.
- Added Appendix F giving an example of all of the Service Attributes for an Operator IP Service.