

# MEF

## Technical Specification

### MEF 37

## Abstract Test Suite

for

ENNI

January 2012

## Disclaimer

The information in this publication is freely available for reproduction and use by any recipient and is believed to be accurate as of its publication date. Such information is subject to change without notice and the Metro Ethernet Forum (MEF) is not responsible for any errors. The MEF does not assume responsibility to update or correct any information in this publication. No representation or warranty, expressed or implied, is made by the MEF concerning the completeness, accuracy, or applicability of any information contained herein and no liability of any kind shall be assumed by the MEF as a result of reliance upon such information.

The information contained herein is intended to be used without modification by the recipient or user of this document. The MEF is not responsible or liable for any modifications to this document made by any other party.

The receipt or any use of this document or its contents does not in any way create, by implication or otherwise:

any express or implied license or right to or under any patent, copyright, trademark or trade secret rights held or claimed by any MEF member company which are or may be associated with the ideas, techniques, concepts or expressions contained herein; nor

any warranty or representation that any MEF member companies will announce any product(s) and/or service(s) related thereto, or if such announcements are made, that such announced product(s) and/or service(s) embody any or all of the ideas, technologies, or concepts contained herein; nor any form of relationship between any MEF member companies and the recipient or user of this document.

Implementation or use of specific Metro Ethernet standards or recommendations and MEF specifications will be voluntary, and no company shall be obliged to implement them by virtue of participation in the Metro Ethernet Forum. The MEF is a non-profit international organization accelerating industry cooperation on Metro Ethernet technology. The MEF does not, expressly or otherwise, endorse or promote any specific products or services.

© The Metro Ethernet Forum 2012. All Rights Reserved.

## Table of Contents

<b>1</b>	<b>Abstract</b> .....	<b>1</b>
<b>2</b>	<b>Terminology</b> .....	<b>1</b>
<b>3</b>	<b>Introduction</b> .....	<b>3</b>
<b>4</b>	<b>Scope</b> .....	<b>3</b>
<b>5</b>	<b>Test Suite Design And Configuration</b> .....	<b>4</b>
5.1	Design Aspects .....	4
5.2	ATS Structure and Usage Guidelines .....	6
5.3	Capabilities .....	7
5.3.1	Major Capabilities .....	7
5.3.2	OVC Capabilities .....	8
5.3.3	ENNI Capabilities .....	9
5.3.4	OVC per ENNI Capabilities .....	9
5.3.5	OVC per UNI Capabilities .....	10
5.3.6	Protection Capabilities .....	10
5.3.7	Bandwidth Profile Capabilities.....	11
5.4	Configuration.....	13
5.4.1	Test Case Test Topologies.....	13
5.4.2	Variables .....	15
5.4.3	ENNI configuration.....	22
5.4.4	OVC configuration.....	25
5.4.5	OVC End Point per ENNI configuration .....	32
5.4.6	UNI configuration .....	42
5.4.7	OVC per UNI configuration.....	43
5.4.8	Suggested Test Flow Configuration .....	51
5.4.9	Default Test Suite Configuration.....	53
5.4.10	Default LACP Configuration.....	53
5.4.11	LACP Configuration.....	54
5.5	Template for Abstract Test Cases .....	59
<b>6</b>	<b>Test Group: Foundation</b> .....	<b>59</b>
6.1	PHY of ENNI Links .....	60
6.2	Single-tagged Frames at ENNI .....	61
6.3	Double-tagged Frames at ENNI, ENNI frames.....	62
6.4	Single-tagged Frames at ENNI with an Invalid FCS, ENNI frames.....	63
6.5	Double-tagged Frames at ENNI with an Invalid FCS, ENNI frames .....	64
6.6	Discarding of Single-tagged ENNI Frames Below Minimum Size.....	65
6.7	Discarding of Double-tagged ENNI Frames Below Minimum Size .....	66
6.8	Single-tagged Frame Forwarding at ENNI and at Maximum Frame Size .....	67
6.9	Double-tagged Frame Forwarding at ENNI and at Maximum Frame Size .....	68
6.10	Frames at ENNI Larger than MTU .....	69
6.11	OVC Mapping by S-VLAN ID.....	70
6.12	Not mapped S-Tagged ENNI Frames .....	71
6.13	Not mapped Untagged ENNI Frames .....	72
6.14	Frame Delivery without Looping.....	73
6.15	Forwarding of Untagged Service Frames of OVC MTUSize.....	74
6.16	Forwarding of Double-Tagged ENNI Frames of OVC MTU Size.....	75
6.17	ENNI Frames Larger Than The OVC MTU Size .....	76
6.18	S-VLAN ID Preservation Set to "No".....	77
6.19	Unconditional Unicast frame Delivery .....	78
6.20	Unconditional Multicast Frame Delivery.....	79
6.21	Unconditional Broadcast Frame Delivery .....	81
6.22	OVC End Point Selection at the UNI by the CE-VLAN ID of Tagged Service Frames .....	82
6.23	Discarding of Tagged Service Frames at the UNI with CE-VLAN ID not Mapped to any OVC End Point .....	83
6.24	Single-tagged Frame Forwarding at ENNI Without CE-VLAN ID Preservation.....	84
6.25	Priority C-tagged Frame Forwarding at ENNI Without CE-VLAN ID Preservation .....	85
6.26	C-tagged Frame Forwarding at ENNI Without CE-VLAN ID Preservation .....	86
6.27	Determination of CoS ID on UNI – OVC End Point at UNI.....	87
6.28	Determination of CoS ID on UNI – C-Tag Priority Code Point.....	88
6.29	Determination of CoS ID on UNI – Service Frames Without C-Tag .....	89
6.30	Determination of CoS ID on UNI – DSCP in IPv4 .....	90
6.31	Determination of CoS ID on UNI – DSCP in IPv6.....	91
6.32	Determination of CoS ID on UNI – DSCP and Non-IP Service Frames .....	92

<b>7</b>	<b>Test Group: Protection.....</b>	<b>93</b>
7.1	Link Aggregation on ENNI with Two Links .....	94
7.2	Basic Interconnection: LACP .....	95
7.3	Active Link in the Protection LAG .....	96
7.4	Passive Link in the Protection LAG.....	97
7.5	Aggregator Parser–forward valid frames (Collection) .....	98
7.6	Aggregator Parser–discard frames (No Collection) .....	99
7.7	Aggregator Parser–forward Marker PDUs (Collection).....	100
7.8	Aggregator Parser–forward Marker PDUs (No Collection) .....	101
7.9	Aggregator Parser–discard invalid Marker PDUs–inopportune .....	102
7.10	Aggregator Multiplexer–forward Marker PDU (No Distribution) .....	103
7.11	Aggregator Multiplexer– forward Marker PDU (Distribution).....	104
7.12	Aggregator Multiplexer–forward frames (Distribution).....	105
7.13	Aggregator Multiplexer–discard frames (No Distribution).....	106
7.14	Control Parser–transparent pass- through (Distribution).....	107
7.15	Control Parser–LACPDU–inopportune .....	108
7.16	Control Parser–LACPDU .....	109
7.17	Control Multiplexer–forward LACPDU .....	110
7.18	Control Multiplexer–transparent pass- through (Distribution) .....	111
7.19	Frame Distributor–Frames (Distribution) .....	112
7.20	Frame Collector–Frames (Collection).....	113
7.21	Marker protocol–Marker Responder (Collection) .....	114
7.22	Port identification .....	115
7.23	System Identification .....	116
7.24	Link Aggregation Group identification .....	117
7.25	Reallocation conversation (Distribution) .....	118
7.26	RM–Entering CURRENT state after Initialization .....	119
7.27	RM–Entering CURRENT state after port up .....	120
7.28	RM–Entering CURRENT state from CURRENT State .....	121
7.29	PM–No Periodic LACPDU when both LACP_Activity are passive .....	122
7.30	PM–Periodic LACPDU during initialization .....	123
7.31	MUX–Entering DETACHED state.....	124
7.32	MUX–Entering ATTACHED state.....	125
7.33	MUX–Entering COLLECTING state .....	126
7.34	MUX–Entering DISTRIBUTING state .....	127
7.35	TM–No Transmission when No Periodic LACPDU .....	128
7.36	RM–Update Partner’s view.....	129
7.37	RM–Unselected in DEFAULTED state.....	130
7.38	RM–Unselected in CURRENT state.....	131
7.39	RM–Selected in CURRENT state.....	132
7.40	RM–Not validated fields.....	133
7.41	MUX–Disabled Distributing in DETACHED state (Distribution).....	134
7.42	MUX–Disabled Collecting in DETACHED state (Collection) .....	135
7.43	MUX–Disabled Collecting in ATTACHED state .....	136
7.44	MUX–Disabled Distributing in COLLECTING state (Collection).....	137
7.45	MUX–Enabled Collecting in COLLECTING state (Collection).....	138
7.46	MUX–Enabled Distributing in DISTRIBUTING state (Distribution).....	139
7.47	LACPDU–All reserved octets.....	140
7.48	LACPDU–Not tagged.....	141
7.49	LACPDU–Structure.....	142
7.50	SMV–Full Duplex .....	143
7.51	SLM–Aggregator .....	144
7.52	SLM–Port Key.....	145
7.53	SLM–Keys same for Aggregator .....	146
7.54	SLM–Keys same for LAG .....	147
7.55	SLM–Not select the same Aggregator .....	148
7.56	PM–SLOW to FAST periodic .....	149
7.57	PM–FAST to SLOW periodic .....	150
7.58	RM–Current_While_timer expired .....	151
7.59	Frame Collector–discard frames within a CollectorMaxDelay time .....	152
<b>8</b>	<b>Test Group: CE-VLAN ID Preservation.....</b>	<b>152</b>
8.1	CE-VLAN ID Preservation for Untagged Service Frames – All OVC UNI’s CE-VLAN IDs Map to the OVC.....	153
8.2	CE-VLAN ID Preservation for Untagged Service Frames – All OVC UNI’s CE-VLAN IDs Map to the OVC.....	154
8.3	CE-VLAN ID Preservation for C-tagged Service Frames – All OVC UNI’s CE-VLAN IDs Map to the OVC.....	155
8.4	CE-VLAN ID Preservation for C-tagged Service Frames –All OVC UNI’s CE-VLAN IDs Map to the OVC.....	156
8.5	CE-VLAN ID Preservation for ENNI Frames With S- and C-tag – All OVC UNI’s CE-VLAN IDs Map to the OVC.....	157
8.6	CE-VLAN ID Preservation for ENNI Frames With S-Tag Only – All OVC UNI’s CE-VLAN IDs Map to the OVC .....	158
8.7	CE-VLAN ID Preservation for ENNI Frames With S- and C-tag – All OVC UNI’s CE-VLAN IDs Map to the OVC.....	159

8.8	CE-VLAN ID Preservation for ENNI frames With S-tag Only – All OVC UNI's CE-VLAN IDs Map to the OVC .....	160
8.9	CE-VLAN ID Preservation for C-tagged Service Frames – Not All OVC UNI's CE-VLAN IDs Map to the OVC.....	161
8.10	CE-VLAN ID Preservation for C-tagged Service Frames – Not All OVC UNI's CE-VLAN IDs Map to the OVC.....	162
8.11	CE-VLAN ID Preservation for ENNI Frames – Not All OVC UNI's CE-VLAN IDs Map to the OVC .....	163
8.12	CE-VLAN ID Preservation for ENNI frames – Not All OVC UNI's CE-VLAN IDs Map to the OVC .....	164
8.13	CE-VLAN ID Preservation for ENNI frames With C- and S-Tag – OVC Without UNI End Points .....	165
8.14	CE-VLAN ID Preservation for ENNI frames With S-Tag Only – OVC Without UNI End Points .....	166
<b>9</b>	<b>Test Group: CE-VLAN CoS Preservation.....</b>	<b>166</b>
9.1	CE-VLAN CoS Preservation for ENNI Frames.....	167
9.2	CE-VLAN CoS Preservation for C-tagged Service Frames .....	168
9.3	CE-VLAN CoS Preservation for C-Tagged Service Frames to UNI.....	169
9.4	CE-VLAN CoS Preservation for ENNI frames.....	170
<b>10</b>	<b>Test Group: Color Forwarding.....</b>	<b>170</b>
10.1	Yellow Color Declaration by UNI Ingress BWP, ENNI Yellow Color Indication by S-VLAN PCP .....	171
10.2	Yellow Color Declaration by UNI Ingress BWP, ENNI Yellow Color Indication by S-VLAN DEI .....	173
10.3	Yellow Ingress Frames at UNI, ENNI Yellow Color Indication by S-VLAN PCP.....	175
10.4	Yellow Ingress Frames at UNI, ENNI Yellow Color Indication by S-VLAN DEI .....	176
10.5	Yellow Color Declaration by ENNI Ingress BWP, ENNI Yellow Color Indication by S-VLAN PCP .....	177
10.6	Yellow Color Declaration by ENNI Ingress BWP, ENNI Yellow Color Indication by S-VLAN DEI .....	179
10.7	Yellow Ingress Frames at ENNI, Yellow Color Indication by S-VLAN PCP at Ingress and Egress ENNI .....	181
10.8	Yellow Ingress Frames at ENNI, Yellow Color Indication by S-VLAN DEI at Ingress and Egress ENNI.....	182
10.9	Yellow Ingress Frames at ENNI, Yellow Color Indication by S-VLAN PCP at Ingress and by S-VLAN DEI at Egress ENNI .....	183
10.10	Yellow Ingress Frames at ENNI, Yellow Color Indication by S-VLAN DEI at Ingress and by S-VLAN PCP at Egress ENNI .....	185
<b>11</b>	<b>Test Group: Class of Service Identifier .....</b>	<b>187</b>
11.1	S-Tag PCP Value's for Class of Service Identifiers Attribute in Exactly one Class of Service Identifier .....	188
11.2	Color Indication at ENNI with S-Tag PCP Value.....	189
11.3	Color Indication at ENNI with S-Tag DEI.....	190
11.4	S-Tag PCP Mapping for MEF 23 CoS Label, Color Indication with S-Tag PCP.....	191
11.5	S-Tag PCP Mapping for MEF CoS Label, Color Indication with DEI .....	192
<b>12</b>	<b>Test Group: ENNI Ingress Bandwidth Profile per CoS .....</b>	<b>193</b>
12.1	ENNI Ingress BWP per CoS with CIR>0, EIR=0, CF=0, EBS=0, CM=1 .....	194
12.2	ENNI Ingress BWP per CoS with CIR=0, CBS=0, EIR>0, CF=0, EBS>0, CM=1 .....	196
12.3	ENNI Ingress BWP per CoS with CIR>0, CBS>0, EIR>0, CF=0, EBS>0, CM=1 .....	198
12.4	ENNI Ingress BWP per CoS: Committed Burst Size, EBS = 0.....	201
12.5	ENNI Ingress BWP per CoS: Excess Burst Size.....	202
<b>13</b>	<b>Test Group: ENNI Egress Bandwidth Profile per CoS .....</b>	<b>203</b>
13.1	ENNI Egress BWP per CoS with CIR>0, EIR=0, CF=0, EBS=0, CM=1 .....	204
13.2	ENNI Egress BWP per CoS with CIR=0, EIR>0, CF=0, EBS>0, CM=1 .....	206
13.3	ENNI Egress BWP per CoS with CIR>0, EIR>0, CF=0, EBS>0, CM=1 .....	208
13.4	ENNI Egress BWP per CoS: Excess Burst Size. ....	210
13.5	ENNI Egress BWP per CoS: Committed Burst Size, EBS = 0.....	211
<b>14</b>	<b>Test Group: UNI Ingress Bandwidth Profile per CoS .....</b>	<b>211</b>
14.1	UNI Ingress BWP per CoS with CIR>0, EIR=0, EBS=0, CF=0, CM=0.....	212
14.2	UNI Ingress BWP per CoS with CIR=0, EIR>0, EBS>0, CF=0, CM=0.....	213
14.3	UNI Ingress BWP per CoS with CIR>0, EIR>0, CF=0, CM=0.....	215
14.4	UNI Ingress BWP per CoS: Committed Burst Size, EBS = 0. ....	217
14.5	UNI Ingress BWP per CoS: Excess Burst Size. ....	218
<b>15</b>	<b>Test Group: UNI Egress Bandwidth Profile per CoS .....</b>	<b>218</b>
15.1	UNI Egress BWP per CoS with CIR>0, EIR=0, EBS= 0, CF=0, CM=0 .....	219
15.2	UNI Egress BWP per CoS with CIR=0, EIR>0, CF=0, CM=0.....	220
15.3	UNI Egress BWP per CoS with CIR>0, EIR>0, CF=0 .....	222
15.4	UNI Egress BWP per CoS: Committed Burst Size, EBS = 0 .....	224
15.5	UNI Egress BWP per CoS: Excess Burst Size.....	225
<b>16</b>	<b>References .....</b>	<b>226</b>
<b>17</b>	<b>Appendix.....</b>	<b>226</b>
17.1	Table of Requirements Derived from the ENNI Specification.....	227
17.2	Metro Ethernet Network (MEN) Interior .....	238

17.2.1	Single Device MEN.....	238
17.2.2	Multiple Device MEN.....	239
17.2.3	Multiple Device, Separate Management .....	239
17.2.4	Vendor vs. Service Provider Testing.....	240
17.3	CBS Test Procedure.....	242
17.4	EBS Test Procedure.....	243

## 1 Abstract

This document defines the updated version of the Abstract Test Suite for External Network Network Interface (ENNI) in accordance with the requirements and service attributes specified in the ENNI Phase 1 Metro Ethernet Forum Technical Committee document, MEF 26.

This document represents the updated versions of the former ENNI Basic ATS and ENNI Protection ATS documents. The original four parts of the project were resplit into two conformance testing levels in 2010. The MEF decided to prioritize test cases verifying a certain group of requirements, as documented in Appendix I. This document defines Abstract Test Cases covering these requirements.

## 2 Terminology

Term	Term Description
<b>BIR</b>	Burst Information Rate; rate in bits per second of service frames transmitted, back-to-back with minimum inter-frame gap. It does not include the inter-frame gap, preamble nor start of frame delimiter. It is called "Burst information rate" because it is equal to the maximum information rate at which bursts can be sent
<b>CE</b>	Customer Edge
<b>Color Forwarding</b>	An OVC attribute defining the relationship between the Color of an egress ENNI Frame and the Color of the corresponding ingress ENNI Frame or Service Frame.
<b>C-Tag</b>	Subscriber VLAN Tag.
<b>C-Tag frames</b>	IEEE 802.1ad Ethernet frames with one tag: C-Tag. The values of the C-VLAN IDs are in the range between 1 and 4094.
<b>BWP</b>	Bandwidth Profile
<b>Double-tagged frames</b>	IEEE 802.1ad Ethernet frames with two tags. The outer tag is an S-Tag, the inner tag is a C-Tag.
<b>DSCP</b>	Diff-Serv Code Point
<b>End Point Map</b>	A mapping of specified S-Tag VLAN ID values to specified OVC End Point Identifiers
<b>End Point Type</b>	A parameter in the End Point Map (In this specification the End Point Type is always OVC End Point.)
<b>ENNI</b>	A reference point representing the boundary between two Operator MENs that are operated as separate administrative domains
<b>ENNI Frame</b>	The first bit of the Destination Address to the last bit of the Frame Check Sequence of the Ethernet Frame transmitted across the ENNI.
<b>ENNI MTU</b>	MTU of an ENNI frame at the ENNI
<b>ENNI-N<sub>i</sub></b>	The functional element administered by the Operator of the <i>i</i> th Operator MEN that supports the protocols and procedures required in [MEF 26].

Term	Term Description
<b>EVC</b>	An association of two or more UNIs
<b>External Interface</b>	Either a UNI or an ENNI <sup>1</sup>
<b>Minimum Inter-Frame Gap</b>	Defined as 96 Bit Times [section 4.4.2 in IEEE Std 802.3-2005]
<b>MEN</b>	Metro Ethernet Network comprising a single administrative domain.
<b>MTU</b>	Maximum Transmission Unit
<b>Network Operator</b>	The Administrative Entity of a MEN.
$N_G$	Smallest compliant value of $W_G$ for a given bandwidth profile
$N_Y$	Smallest compliant value of $W_Y$ for a given bandwidth profile
<b>Operator Virtual Connection</b>	An association of OVC End Points
<b>OVC</b>	Operator Virtual Connection.
<b>OVC End Point</b>	An association of an OVC with a specific External Interface i.e., UNI, ENNI.
<b>OVC Identifier</b>	String that is unique among all OVCS in the Operator MEN
<b>Service Frame</b>	An Ethernet frame transmitted across the UNI toward the Service Provider or an Ethernet frame transmitted across the UNI toward the Subscriber
<b>Service Provider</b>	The organization responsible for the UNI to UNI Ethernet service
<b>S-Tag</b>	Service VLAN Tag.
<b>S-Tag frames</b>	IEEE 802.1ad Ethernet frames with one tag: S-Tag. The values of the S-VLAN IDs are in the range between 1 and 4094.
<b>Subscriber</b>	The organization purchasing and/or using Ethernet Services.
<b>S-VLAN ID</b>	The 12 bit VID field in the S-Tag of an ENNI Frame.
<b>Tag</b>	An optional field in a frame header. In this document it is the 4-byte field that, when present, appears immediately after the Source Address, or another tag in an Ethernet frame header and which consists of the 2-byte Tag Protocol Identification Field (TPID) which indicates S-Tag or C-Tag, and the 2-byte Tag Control Information field (TCI) which contains the 3-bit Priority Code Point, and the 12-bit VLAN ID field
<b>UNI</b>	The physical demarcation point between the responsibility of the Service Provider and the responsibility of the Subscriber.
$W_G$	The amount of traffic declared green during any test duration, lower bounded by the definition in MEF10.2 section 7.11.1.
$W_Y$	The amount of traffic declared yellow during any test duration, lower bounded by the definition in MEF 10.2 section 7.11.1.

<sup>1</sup> MEF 4 considers several types of External Interfaces. This document is limited to consideration of the UNI and ENNI.



### **3 Introduction**

With the growing number of service providers, different services and the growing size of networks the market demands solutions for realizing EVC services over multiple carriers or administrative domains.

Carrier Ethernet is a technology that intends to cover such market demand. MEF specifies services, network interfaces, such as ENNI or UNI, and the technologies that need to be supported by the network interfaces in order to provide the support for transparent services. The interface between two administrative domains is called External Network Network Interface (ENNI). It is crucial to Ethernet services spanning multiple MEFs to run over well-specified ENNI because the two different MEFs could consist of different network devices and transport technologies.

### **4 Scope**

The Abstract Test Suite is defined according to the MEF 26 specification, which determines the conformance of several ENNI implementations to the specification. The test suite also intends to improve vendor and operator interoperability, which is crucial for services spanning more than one Metro Ethernet Network.

## 5 Test Suite Design And Configuration

### 5.1 Design Aspects

The test suite defined in this document follows some basic design aspects listed below:

- The test method is black box testing, no assumptions about the internal design of the Operator MEN is made.
- Points of Control and Observation (PCOs) are External Interfaces only
- Capability Tables describe protocol features, which must or may be implemented.
- ENNI, UNI and OVC/EVC configuration may differ for various Operator MEN because of different sets of supported protocol capabilities.
- The field "Conditions" in each test case defines OVC, ENNI, and UNI capabilities that must be supported and enabled by the Operator MEN in order to execute that particular test case.
- Test cases indicate their mandatory, conditionally mandatory or optional status in the "Test Status" field:
  - o Mandatory: The test case verifies a mandatory MEF26 requirement for any Operator MEN and must be performed.
  - o Conditionally Mandatory: The test case verifies a MEF26 requirement that an Operator MEN must fulfill if a test case-specific combination of optional features are implemented and advertised as such. The test case must be performed if the Operator MEN is capable of meeting conditions specified in the "Conditions" field.
  - o Optional: The test case covers an optional feature that may be implemented, but is not required to meet MEF26 compliance.
  - o

Figure 1 shows the conceptual testing topology. At least two interfaces, one of them an ENNI, must be supported by an Operator MEN in order to be able to perform the tests specified in this document.

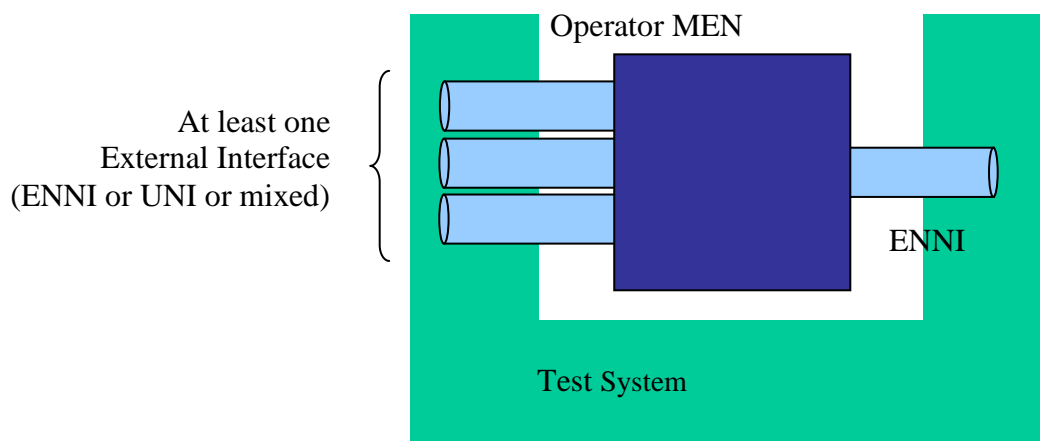

**Figure 1: Conceptual testing topology**



## 5.2 ATS Structure and Usage Guidelines

This document describes a number of conformance test cases that verify ENNI requirements defined in MEF 26. Not all MEF 26 requirements are covered by test cases. Which particular requirements are covered by this document is described in the Appendix.

To parametrize each test case, the document specifies detailed configurations required for test execution at a central place in the next subsection. The ENNI, OVC, and end point configurations can become quite extensive. If listed individually with each test case, they would require multiple pages per test case. In order to reduce the total size of the ATS and the amount of duplicate information, all repeatedly-referenced configuration items are summarized in section 5. The configuration is split into two major parts: Operator MEN capabilities are described in section 5.3, ATS configuration is defined in section 5.4.

Figure 2 illustrates the relationship of document sections:

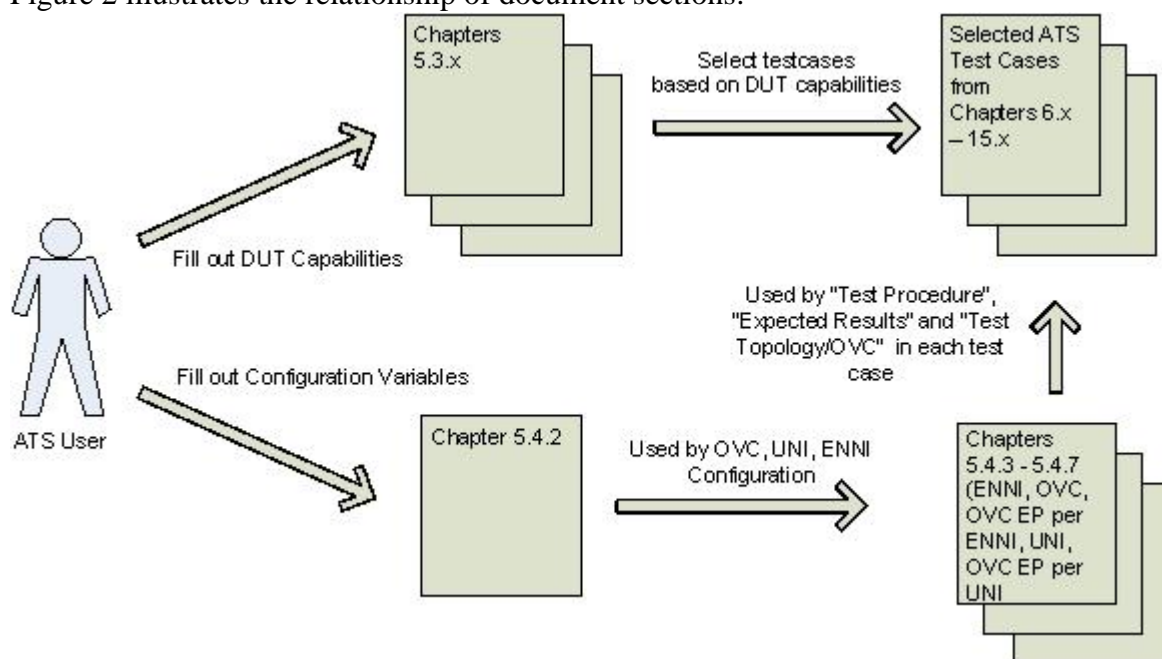

Figure 2: ATS Structure

Test cases contain links to the referenced configuration tables– typically the object names in the topology are linked. In order to navigate through the ATS efficiently, the following procedures are recommended:

Action	Solution in WinWord	Solution in Adobe PDF
Identify Reference	Mouseover while Ctrl key is pressed; mouse cursor shows hand symbol over active reference	
Follow Reference	Ctrl-Left click	Ctrl-Left click
Navigate Back To Source	Alt-Left Arrow	Alt-Left Arrow
Navigate Forward		Alt-Right Arrow

### 5.3 Capabilities

A specific Operator MEN under test may not implement all optional features as described in MEF26. Any conditional test case is applicable under a combination of features supported by a given system under test as indicated in the test case's "Conditions" field. In order to simplify the test case selection process, this section describes and summarizes the ENNI specification capabilities below. The ENNI capabilities were derived from the requirements and attributes for ENNI, OVC, OVC End Point per ENNI, and OVC per UNI defined in the ENNI specification. The ENNI capabilities are grouped in the following tables, which provide:

- An overview over all ENNI capabilities
- Dependencies between particular ENNI specification capabilities
- Statement, whether a feature is mandatory or optional
- Precondition for an implementation that intends to perform this test suite.
- Test execution preconditions in terms of enabled or disabled ENNI capabilities

The status column indicates if the feature is mandatory (M) or optional (O). The status can be conditionally expressed:

- O.<n> means that this capability is optional, but at least one capability in the group of features labeled by the same number <n> must be supported.
- <feature>:<s> means that if the support of the feature <feature> is true (the feature is referenced by its ID), then the requirements are as per the status <s>, M or O.

Unique capability identification is provided by the "Item" column (short ID) and a more human readable "String ID". The text in "Item" is sometimes used in the "Status" column of capability tables to indicate a dependency. The "String ID" is used in the "Conditions" field of the test cases.

The Support column identifies whether a particular MEF26 feature is supported by the system under test. All Mandatory features (Status = "M") must be supported and indicated with "Yes" checked. There is no option for "No", because the system under test would be non-compliant to MEF26.

#### 5.3.1 Major Capabilities

**Table 1: Major capabilities**

Item	String ID	Feature	Reference	Status	Support
MC1	Number of ENNIs > 0	Does the implementation support at least 1 ENNI?	[MEF 26], 7.1	M	Yes <input type="checkbox"/>
MC2	Number of ENNIs > 1	Does the implementation support at least 2 ENNIs?	[MEF 26], 7.1	O.1	Yes <input type="checkbox"/> No <input type="checkbox"/>
MC3	Number of ENNIs > 2	Does the implementation support at least 3 ENNIs?	[MEF 26], 7.1	MC2:O	Yes <input type="checkbox"/> No <input type="checkbox"/> N/A <input type="checkbox"/>
MC4	Number of UNIs > 0	Does the implementation support at least 1 UNI?	[MEF 26], 7.2.3	O.1	Yes <input type="checkbox"/> No <input type="checkbox"/>
MC5	Number of UNIs > 1	Does the implementation support at least 2 UNIs?	[MEF 26], 7.2.3	MC4:O	Yes <input type="checkbox"/> No <input type="checkbox"/> N/A <input type="checkbox"/>
MC6	Link OAM	Does the implementation support Link OAM as specified in section 8 of [MEF 26]?	[MEF 26], 8	O	Yes <input type="checkbox"/> No <input type="checkbox"/>

## 5.3.2 OVC Capabilities

Table 2: OVC capabilities

Item	String ID	Feature	Reference	Status	Support
CC1	Number of UNI OVC End Points > 0	Does the implementation support 0 or at least 1 UNI OVC End Point?	[MEF 26], 7.2.7	MC4:M	Yes <input type="checkbox"/> N/A <input type="checkbox"/>
CC2	Number of UNI OVC End Points > 1	Does the implementation support at least 2 UNI OVC End Points?	[MEF 26], 7.2.7	MC5:M	Yes <input type="checkbox"/> N/A <input type="checkbox"/>
CC3	Number of ENNI OVC End Points > 0	Does the implementation support at least 1 ENNI OVC End Point?	[MEF 26], 7.2.8	MC1:M	Yes <input type="checkbox"/> N/A <input type="checkbox"/>
CC4	Number of ENNI OVC End Points > 1	Does the implementation support at least 2 ENNI OVC End Points at different ENNIs?	[MEF 26], 7.2.8	MC2:M	Yes <input type="checkbox"/> N/A <input type="checkbox"/>
CC5	Number of ENNI OVC End Points > 2	Does the implementation support at least 3 ENNI OVC End Points at different ENNIs?	[MEF 26], 7.2.8	MC3:M	Yes <input type="checkbox"/> N/A <input type="checkbox"/>
CC6	Number of OVC End Points per ENNI > 1	Does the implementation support at least 2 ENNI OVC End Points at a particular ENNI?	[MEF 26], 7.2.1, O1	O	Yes <input type="checkbox"/> No <input type="checkbox"/>
CC7	End Point Map Bundling	Does the implementation support more than one S-VLAN ID value map to the OVC End Point in the End Point Map?	[MEF 26], 7.1.7.2	O	Yes <input type="checkbox"/> No <input type="checkbox"/>
CC8	CE-VLAN ID preservation	Does the implementation supports the CE-VLAN ID preservation?	[MEF 26], 7.2.10	O	Yes <input type="checkbox"/> No <input type="checkbox"/>
CC9	CE-VLAN CoS preservation	Does the implementation supports the CE-VLAN CoS preservation?	[MEF 26], 7.2.11	O	Yes <input type="checkbox"/> No <input type="checkbox"/>
CC10	All OVC UNI's CE-VLAN IDs map to the OVC	Does the implementation support mapping of all CE-VLAN ID to an OVC at a UNI?	[MEF 26], R35	O	Yes <input type="checkbox"/> No <input type="checkbox"/>
CC11	S-VLAN ID preservation	Does the implementation supports the S-VLAN ID preservation and the S-VLAN ID preservation can be set to one of the following values: "Yes", "No"?	[MEF 26], 7.2.12	O	Yes <input type="checkbox"/> No <input type="checkbox"/>
CC12	OVC MTU	Does the implementation support at least 1526 bytes OVC Maximum Transmission Unit Size?	[MEF 26], 7.2.9	M	Yes <input type="checkbox"/>
CC13	Unconditional Unicast Frame Delivery	Does the implementation support unconditional unicast frame delivery?	[MEF 26], 7.2.16	M	Yes <input type="checkbox"/>

Item	String ID	Feature	Reference	Status	Support
CC14	Unconditional Multicast Frame Delivery	Does the implementation support unconditional multicast frame delivery?	[MEF 26], 7.2.17	M	Yes <input type="checkbox"/>
CC15	Unconditional Broadcast Frame Delivery	Does the implementation support unconditional broadcast frame delivery?	[MEF 26], 7.2.18	M	Yes <input type="checkbox"/>
CC16	Conditional Unicast Frame Delivery	Does the implementation support conditional unicast frame delivery?	[MEF 26], 7.2.16	O	Yes <input type="checkbox"/> No <input type="checkbox"/>
CC17	MAC Address Learning	Does the implementation support MAC address learning?	[MEF 26], 7.2.16	CC16:O	Yes <input type="checkbox"/> No <input type="checkbox"/> N/A <input type="checkbox"/>
CC18	Conditional Multicast Frame Delivery	Does the implementation support conditional multicast frame delivery?	[MEF 26], 7.2.17	O	Yes <input type="checkbox"/> No <input type="checkbox"/>
CC19	Conditional Broadcast Frame Delivery	Does the implementation support conditional broadcast frame delivery?	[MEF 26], 7.2.18	O	Yes <input type="checkbox"/> No <input type="checkbox"/>
CC20	Frame Forwarding to Specific EI	Does the implementation support frame forwarding to specific External Interfaces (EI) only based on specific destination MAC addresses (MAC filtering)?	[MEF 26], 7.2.16, 7.2.17, 7.2.18	(CC18 OR CC19):O	Yes <input type="checkbox"/> No <input type="checkbox"/> N/A <input type="checkbox"/>

### 5.3.3 ENNI Capabilities

**Table 3: ENNI capabilities**

Item	String ID	Feature	Reference	Status	Support
EC1	Number of Links at ENNI = 2	Does the implementation support 2 links at ENNI?	[MEF 26], 7.1.4	O	Yes <input type="checkbox"/> No <input type="checkbox"/>
EC2	ENNI MTU	Does the implementation support at least 1526 bytes Maximum Transmission Unit Size at ENNI?	[MEF 26], 7.1.6	M	Yes <input type="checkbox"/>

### 5.3.4 OVC per ENNI Capabilities

**Table 4: OVC per ENNI capabilities**

Item	String ID	Feature	Reference	Status	Support
CEC1	End Point Map	Does the implementation support the End Point Map?	[MEF 26], 7.1.7	M	Yes <input type="checkbox"/>
CEC2	Number of ENNI CoS > 1	Does the implementation support at least 2 different Classes of Services at the ENNI?	[MEF 26], 7.3.2	O	Yes <input type="checkbox"/> No <input type="checkbox"/>

Item	String ID	Feature	Reference	Status	Support
CEC3	Discard CoS at ENNI	Does the implementation support a CoS with 100% loss?	[MEF 26], 7.3.2	CEC2:O	Yes <input type="checkbox"/> No <input type="checkbox"/> N/A <input type="checkbox"/>
CEC4	Classifying based on S-Tag PCP	Does the implementation determine the different Classes of Service based on S-Tag Priority Code Point at the ENNI?	[MEF 26], 7.3.2	CEC2:M	Yes <input type="checkbox"/> N/A <input type="checkbox"/>

### 5.3.5 OVC per UNI Capabilities

**Table 5: OVC per UNI capabilities**

Item	String ID	Feature	Reference	Status	Support
OU1	Untagged frames at UNI	Does the implementation support mapping of untagged frames at the UNI to an OVC?	[MEF 26], 7.5.2	O	Yes <input type="checkbox"/>
OU2	<u>Priority Tagged Frames at UNI</u>	Does the implementation support mapping of priority tagged frames at the UNI to an OVC?	[MEF 26], 7.5.2	O	Yes <input type="checkbox"/> No <input type="checkbox"/>
OU3	Tagged frames at UNI	Does the implementation support mapping of tagged frames at the UNI to an OVC?	[MEF 26], 7.5.2	O	Yes <input type="checkbox"/> No <input type="checkbox"/>
OU4	Number of UNI CoS > 1	Does the implementation support at least two different Classes of Services at the UNI?	[MEF 26], 7.5	MC4:O	Yes <input type="checkbox"/> No <input type="checkbox"/> N/A <input type="checkbox"/>
OU5	Discard CoS at UNI	Does the implementation support a CoS with 100% loss at UNI?	[MEF 26], 7.5	OU4:O	Yes <input type="checkbox"/> No <input type="checkbox"/> N/A <input type="checkbox"/>
OU6	Classifying based on OVC End Point	If the implementation supports UNI, does it determine the different Classes of Services based on OVC End Point at the UNI?	[MEF 26], 7.5.3.1, R71	OU4:O	Yes <input type="checkbox"/> No <input type="checkbox"/> N/A <input type="checkbox"/>
OU7	Classifying based on C-Tag PCP	If the implementation supports UNI, does it determine the different Classes of Services based on C-Tag Priority Code Point at the UNI?	[MEF 26], 7.5.3.2	OU4:O	Yes <input type="checkbox"/> No <input type="checkbox"/> N/A <input type="checkbox"/>
OU8	Classifying based on DSCP in IPv4	If the implementation supports UNI, does it determine the different Classes of Services based on DiffServ Code Points encoded in IPv4's ToS field at the UNI?	[MEF 26], 7.5.3.3	OU4:O	Yes <input type="checkbox"/> No <input type="checkbox"/> N/A <input type="checkbox"/>
OU9	Classifying based on DSCP in IPv6	If the implementation supports UNI, does it determine the different Classes of Services based on DiffServ Code Points encoded in IPv6's Traffic Class octet at the UNI?	[MEF 26], 7.5.3.3	OU4:O	Yes <input type="checkbox"/> No <input type="checkbox"/> N/A <input type="checkbox"/>
OU10	Bundling	Does the implementation support Bundling at the UNI?	[MEF 26], 7.1.7	OU4:O	Yes <input type="checkbox"/> No <input type="checkbox"/>

### 5.3.6 Protection Capabilities

**Table 6: Protection capabilities**

Item	String ID	Feature	Reference	Status	Support
PR1	Protection Mechanism	Does the implementation support Protection Mechanism?	[MEF 26], 6	EC1:M	Yes <input type="checkbox"/> N/A <input type="checkbox"/>



Item	String ID	Feature	Reference	Status	Support
PR2	LAG	Does the implementation support Link Aggregation on the ENNI-Ni?	[MEF 26], 6	PR1:M	Yes <input type="checkbox"/> N/A <input type="checkbox"/>
PR3	LACP	Does the implementation support Link Aggregation Control Protocol (LACP) on the ENNI-Ni?	[MEF 26], 6	PR2:M	Yes <input type="checkbox"/> N/A <input type="checkbox"/>
PR4	Other Protection Mechanism	Does an implementation support other protection mechanism than LAG?	[MEF 26], 7.1.5	PR1:O	Yes <input type="checkbox"/> No <input type="checkbox"/> N/A <input type="checkbox"/>

### 5.3.7 Bandwidth Profile Capabilities

**Table 7: Bandwidth Profile capabilities**

Item	String ID	Feature	Reference	Status	Support
BWP1	Color Forwarding	Does the implementation support the Color Forwarding?	[MEF 26], 7.2.14	O	Yes[.....]No[ ]
BWP2	Ingress Bandwidth Profile per OVC End Point at ENNI	Does the implementation support Ingress Bandwidth Profile per OVC End Point at ENNI?	[MEF 26], 7.3.3	M	Yes[.....]No[ ]
BWP3	Egress Bandwidth Profile per OVC End Point at ENNI	Does the implementation support Egress Bandwidth Profile per OVC End Point at ENNI?	[MEF 26], 7.3.4	M	Yes[.....]No[ ]
BWP4	Ingress Bandwidth Profile per Class of Service Identifier at ENNI	Does the implementation support Ingress Bandwidth Profile per Class Of Service Identifier at ENNI?	[MEF 26], 7.3.5	M	Yes[.....]No[ ]
BWP5	Egress Bandwidth Profile per Class Of Service Identifier at ENNI	Does the implementation support Egress Bandwidth Profile per Class Of Service Identifier at ENNI?	[MEF 26], 7.3.6	M	Yes[.....]No[ ]
BWP6	Ingress Bandwidth Profile per OVC End Point at UNI	Does the implementation support Ingress Bandwidth Profile per OVC End Point at UNI?	[MEF 26], 7.5.4	O	Yes[.....]No[ ]
BWP7	Ingress Bandwidth Profile per Class of Service Identifier at UNI	Does the implementation support Ingress Bandwidth Profile per Class of Service Identifier at UNI?	[MEF 26], 7.5.5	M	Yes[.....]No[ ]
BWP8	Egress Bandwidth Profile per OVC End Point at UNI	Does the implementation support Egress Bandwidth Profile per OVC End Point at a UNI?	[MEF 26], 7.5.6	O	Yes[.....]No[ ]
BWP9	Egress Bandwidth Profile per Class of Service Identifier at UNI	Does the implementation support Egress Bandwidth Profile per Class of Service Identifier at a UNI?	[MEF 26], 7.5.7	M	Yes[.....]No[ ]
BWP10	Simultaneous Ingress Bandwidth Profile	Does the implementation support simultaneous Ingress Bandwidth Profile?	[MEF 26], 7.6.2.1	O	Yes[.....]No[ ]
BWP11	Simultaneous Egress Bandwidth Profile	Does the implementation support simultaneous Egress Bandwidth Profile?	[MEF 26], 7.6.3.1	O	Yes[.....]No[ ]
BWP12	Per Frame Color Identifier	Does the implementation support per frame color Identifier?	[MEF 23], 6.3.3	M	Yes[.....]No[ ]

Item	String ID	Feature	Reference	Status	Support
BWP13	DEI Color Indication	Does the implementation support the use of DEI field to indicate color	[MEF 23], 6.3.3	<b>Error! Reference source not found.:O</b>	Yes[.....]No[] N/A []
BWP14	S-tag PCP Color Indication	Does the implementation support the use of S-Tag PCP field for color indication?	[MEF 23], 6.3.3	<b>Error! Reference source not found.:M</b>	Yes[.....]No[] N/A []
BWP15	Color Aware for ENNI Ingress Bandwidth Profile per CoS	Does the implementation support color aware mode for ENNI ingress bandwidth profile per CoS	[MEF26], 7.3.5	M	Yes[]
BWP16	Color Aware for ENNI Egress Bandwidth Profile per CoS	Does the implementation support color aware mode for ENNI egress bandwidth profile per CoS	[MEF26], 7.3.6	M	Yes[]
BWP17					
BWP18					

## 5.4 Configuration

This chapter specifies configuration and configuration parameters of the Operator Metro Ethernet Network (MEN) and the Tester needed for test suite execution.

Before a test suite execution a particular test topology and configuration will be selected based on the supported Operator MEN capabilities.

The configuration is provided by multiple tables. A table consists of an "Attribute Name", "Description", and "Value" column. "Attribute Name" identifies Service Attributes defined in ENNI specification [MEF 26]. The Service Attributes may be referenced by their names from the test case procedure and test case expected results. The column "Value" specifies a specific fixed value of the Service Attribute or a variable, which need to be set prior the test suite execution. All configuration variables are defined in Table 8.

### 5.4.1 Test Case Test Topologies

Each test case reference to one of the topologies defined in this section that is at minimum required for the test case execution.

The Test Topology 1 as shown in Figure 3 is referenced by test cases that require "Number of UNIs > 0" and "Number of ENNIs > 0" capabilities to be supported.

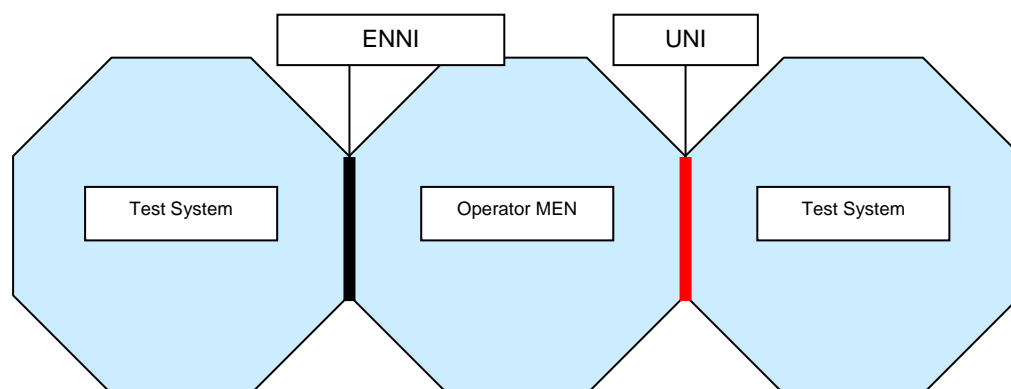

**Figure 3: Test Topology 1**

The Test Topology 2 as shown in Figure 4 is referenced by test cases that require "Number of ENNIs > 1" capability to be supported.

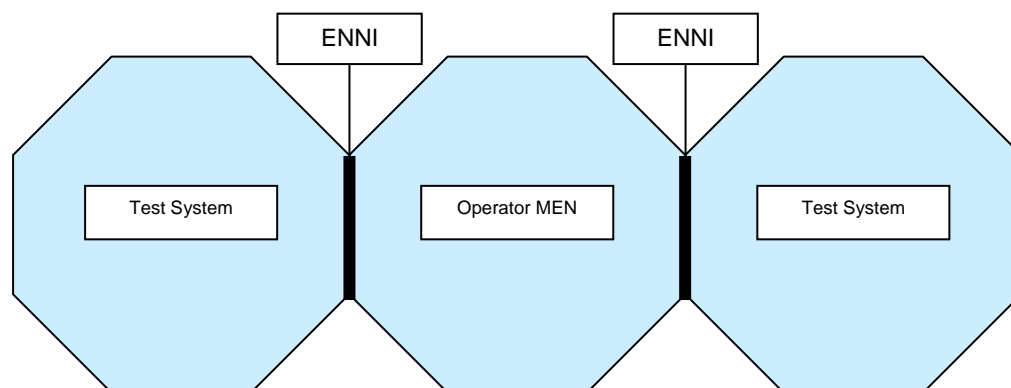

**Figure 4: Test Topology 2**

The Test Topology 3 as shown in Figure 5 is referenced by test cases that require "Number of ENNIs > 0" and "Number of UNIs > 1" capability to be supported.

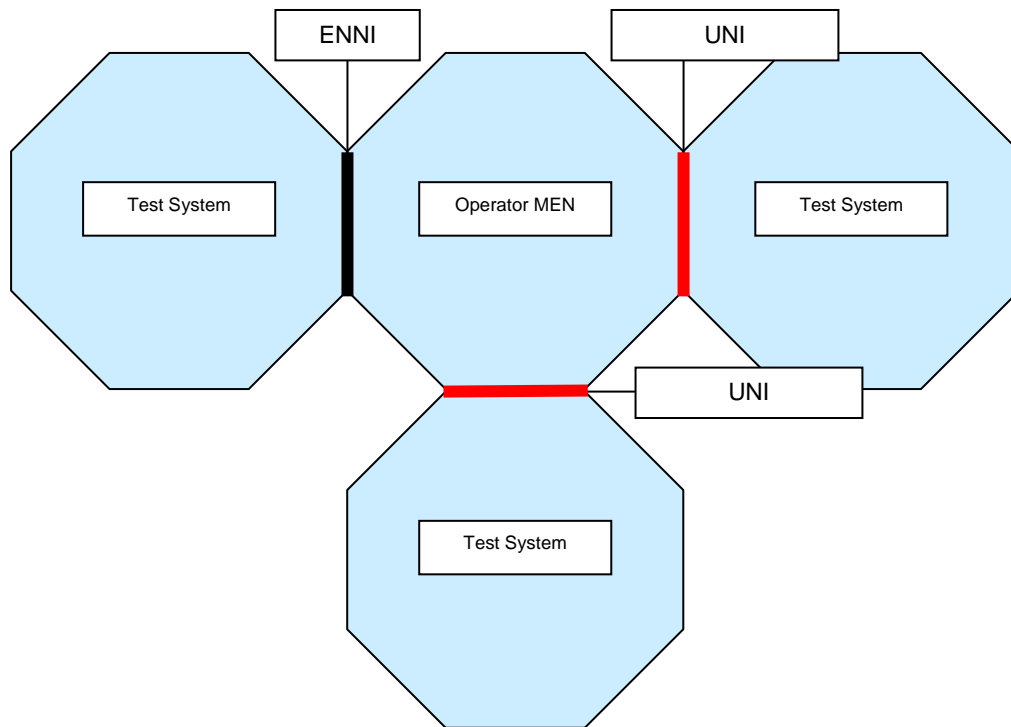

**Figure 5: Test Topology 3**

The Test Topology 4 as shown in Figure 6 is referenced by test cases that require "Number of ENNIs > 2" capability to be supported.

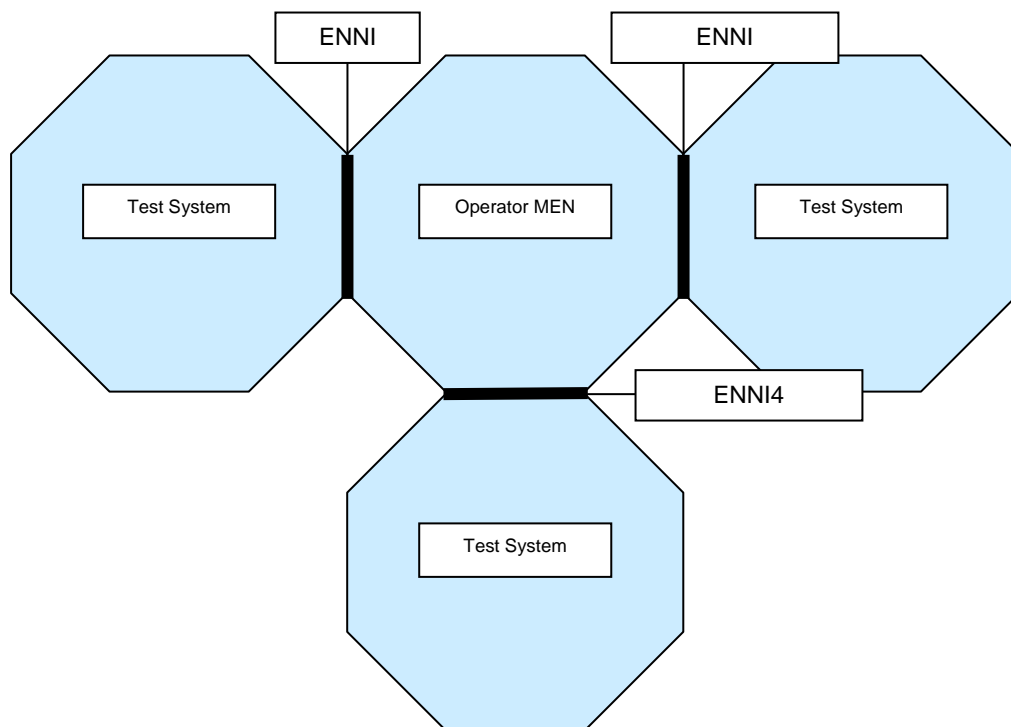

**Figure 6: Test Topology 4**

The Test Topology 5 as shown in Figure 7 is referenced by test cases that require "Number of ENNIs > 1" and "Number of UNIs > 0" capabilities to be supported.

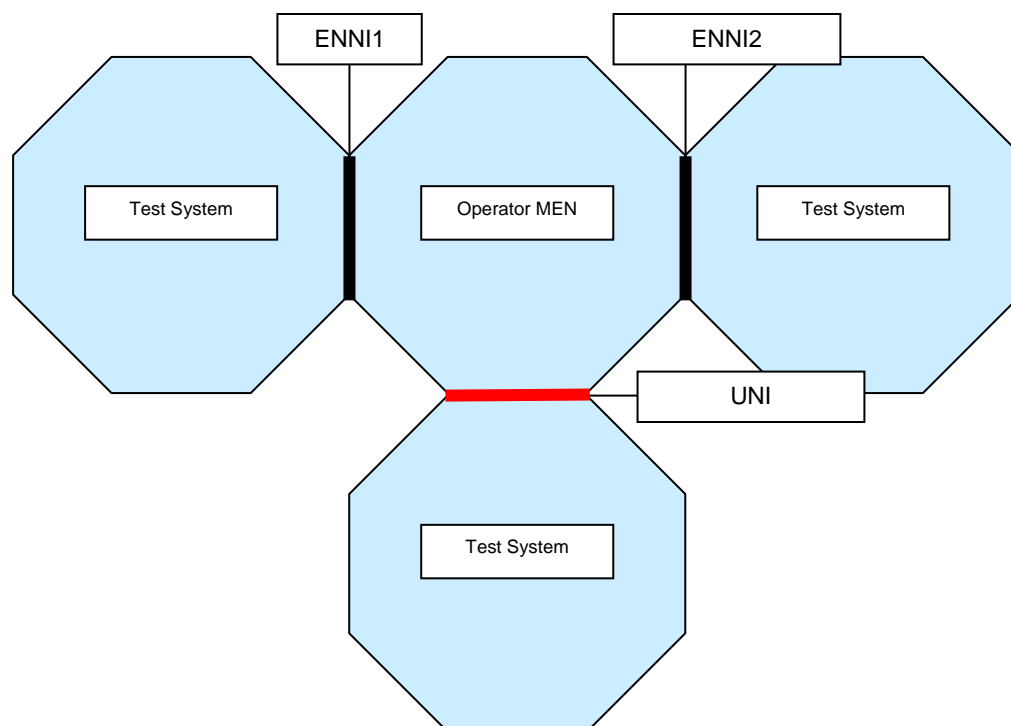

Figure 7: Test Topology 5

### 5.4.2 Variables

A test case procedure and expected results often need to operate with some specific values, e.g. if a specific S-VLAN ID value in the received frames is expected. One way would be to directly specify these values in the test case, e.g. all received frames are expected to have an S-VLAN ID 12, if the tester generated the test frames with C-VLAN ID 10. The specific values however would make the usage of the ATS inflexible, then for some specific reasons the Operator MEN might not configure a test OVC with that values, e.g. because the S-VLAN ID 12 is reserved in the Operator MEN for management purposes. Each test procedure in this ATS refers back to one or more of the tables in this section. Instead of specifying specific values in the test cases, the ATS uses variables. The variables and requirements for the values of these variables are listed in the table below.

Table 8: Implementation specific variables

String ID	Description	Possible Values
ENNI_MTU	The variable defines Maximum Transmission Unit size of frames at ENNI.	An integer number of bytes greater than or equal to 1526 and less than 2000.
OVC_MTU	The variable defines Maximum Transmission Unit size of frames transmitting over an OVC.	An integer number of bytes greater than or equal to 1526 and less than 2000.
UNI_MTU	The variable defines Maximum Transmission Unit size of frames at UNI.	An integer number of bytes greater than or equal to 1522

String ID	Description	Possible Values
EVC_MTU	The variable defines Maximum Transmission Unit size of frames for EVCs.	An integer number of bytes greater than or equal to 1522
ENNI_PHY	The physical layer of the links supporting the ENNI	One of the list as specified in R6 of [MEF 26]
UNI_PHY	The physical layer of the links supporting the UNI	One of the list as specified in section 7.2 of [MEF 10.2]
OVC_Max_Number_ENNI	The maximum number of OVCs that can be configured at ENNI.	An integer number greater than or equal to 1
EVC_Max_Number_UNI	The maximum number of EVCs that can be configured at UNI.	An integer number greater than or equal to 1
OVC/EVC_Max_Number_EI	A maximum number of OVCs or EVCs that are supported at all External Interfaces used for ATS execution	A minimum value of OVC_Max_Number_ENNI and EVC_Max_Number_UNI
SVID1	An S-VLAN ID value	An integer number between 1 and 4094. The value must be unique among all SVID variable values.
SVID2	An S-VLAN ID value.	An integer number between 1 and 4094. The value must be unique among all SVID variable values.
SVID3	An S-VLAN ID value.	An integer number between 1 and 4094. The value must be unique among all SVID variable values.
SVID4	An S-VLAN ID value.	An integer number between 1 and 4094. The value must be unique among all SVID variable values.
SVID5	An S-VLAN ID value.	An integer number between 1 and 4094. The value must be unique among all SVID variable values.
SVID6	An S-VLAN ID value.	An integer number between 1 and 4094. The value must be unique among all SVID variable values.
SVID7	An S-VLAN ID value.	An integer number between 1 and 4094. The value must be unique among all SVID variable values.
SVID8	An S-VLAN ID value.	An integer number between 1 and 4094. The value must be unique among all SVID variable values.
SVID9	An S-VLAN ID value.	An integer number between 1 and 4094. The value must be unique among all SVID variable values.
SVID10	An S-VLAN ID value.	An integer number between 1 and 4094. The value must be unique among all SVID variable values.
SVID11	An S-VLAN ID value.	An integer number between 1 and 4094. The value must be unique among all SVID variable values.
SVID12	An S-VLAN ID value.	An integer number between 1 and 4094. The value must be unique among all SVID variable values.
SVID13	An S-VLAN ID value.	An integer number between 1 and 4094. The value must be unique among all SVID variable values.

String ID	Description	Possible Values
SVID14	An S-VLAN ID value.	An integer number between 1 and 4094. The value must be unique among all SVID variable values.
SVID15	An S-VLAN ID value.	An integer number between 1 and 4094. The value must be unique among all SVID variable values.
SVID16	An S-VLAN ID value.	An integer number between 1 and 4094. The value must be unique among all SVID variable values.
SVID17	An S-VLAN ID value.	An integer number between 1 and 4094. The value must be unique among all SVID variable values.
SVID18	An S-VLAN ID value.	An integer number between 1 and 4094. The value must be unique among all SVID variable values.
SVID19	An S-VLAN ID value.	An integer number between 1 and 4094. The value must be unique among all SVID variable values.
SVID20	An S-VLAN ID value.	An integer number between 1 and 4094. The value must be unique among all SVID variable values.
SVID21	An S-VLAN ID value.	An integer number between 1 and 4094. The value must be unique among all SVID variable values.
SVID22	An S-VLAN ID value.	An integer number between 1 and 4094. The value must be unique among all SVID variable values.
SVID23	An S-VLAN ID value.	An integer number between 1 and 4094. The value must be unique among all SVID variable values.
SVID24	An S-VLAN ID value.	An integer number between 1 and 4094. The value must be unique among all SVID variable values.
SVID25	An S-VLAN ID value.	An integer number between 1 and 4094. The value must be unique among all SVID variable values.
SVID26	An S-VLAN ID value.	An integer number between 1 and 4094. The value must be unique among all SVID variable values.
SVID27	An S-VLAN ID value.	An integer number between 1 and 4094. The value must be unique among all SVID variable values.
SVID28	An S-VLAN ID value.	An integer number between 1 and 4094. The value must be unique among all SVID variable values.
SVID29	An S-VLAN ID value.	An integer number between 1 and 4094. The value must be unique among all SVID variable values.
SVID30	An S-VLAN ID value.	An integer number between 1 and 4094. The value must be unique among all SVID variable values.
SVID31	An S-VLAN ID value.	An integer number between 1 and 4094. The value must be unique among all SVID variable values.

String ID	Description	Possible Values
SVID32	An S-VLAN ID value.	An integer number between 1 and 4094. The value must be unique among all SVID variable values.
SVID33	An S-VLAN ID value.	An integer number between 1 and 4094. The value must be unique among all SVID variable values.
SVID34	An S-VLAN ID value.	An integer number between 1 and 4094. The value must be unique among all SVID variable values.
SVID35	An S-VLAN ID value.	An integer number between 1 and 4094. The value must be unique among all SVID variable values.
SVID36	An S-VLAN ID value.	An integer number between 1 and 4094. The value must be unique among all SVID variable values.
SVID37	An S-VLAN ID value.	An integer number between 1 and 4094. The value must be unique among all SVID variable values.
SVID38	An S-VLAN ID value.	An integer number between 1 and 4094. The value must be unique among all SVID variable values.
SVID39	An S-VLAN ID value.	An integer number between 1 and 4094. The value must be unique among all SVID variable values.
SVID40	An S-VLAN ID value.	An integer number between 1 and 4094. The value must be unique among all SVID variable values.
SVID41	An S-VLAN ID value.	An integer number between 1 and 4094. The value must be unique among all SVID variable values.
SVID42	An S-VLAN ID value.	An integer number between 1 and 4094. The value must be unique among all SVID variable values.
SVID43	An S-VLAN ID value.	An integer number between 1 and 4094. The value must be unique among all SVID variable values.
SVID44	An S-VLAN ID value.	An integer number between 1 and 4094. The value must be unique among all SVID variable values.
SVID45	An S-VLAN ID value.	An integer number between 1 and 4094. The value must be unique among all SVID variable values.
SVID46	An S-VLAN ID value.	An integer number between 1 and 4094. The value must be unique among all SVID variable values.
CVID_Default	A CE-VLAN ID value for untagged and priority tagged frames at UNI.	An integer number between 1 and 4094. The value must be unique among all CVID variable values.
CVID1	A CE-VLAN ID value for tagged frames at UNI.	An integer number between 1 and 4094. The value must be unique among all CVID variable values.
CVID2	A CE-VLAN ID value for tagged frames at UNI.	An integer number between 1 and 4094. The value must be unique among all CVID variable values.



String ID	Description	Possible Values
CVID3	A CE-VLAN ID value for tagged frames at UNI.	An integer number between 1 and 4094. The value must be unique among all CVID variable values.
CVID4	A CE-VLAN ID value for tagged frames at UNI.	An integer number between 1 and 4094. The value must be unique among all CVID variable values.
CVID5	A CE-VLAN ID value for tagged frames at UNI.	An integer number between 1 and 4094. The value must be unique among all CVID variable values.
CVID6	A CE-VLAN ID value for tagged frames at UNI.	An integer number between 1 and 4094. The value must be unique among all CVID variable values.
CVID7	A CE-VLAN ID value for tagged frames at UNI.	An integer number between 1 and 4094. The value must be unique among all CVID variable values.
CVID8	A CE-VLAN ID value for tagged frames at UNI.	An integer number between 1 and 4094. The value must be unique among all CVID variable values.
CVID9	A CE-VLAN ID value for tagged frames at UNI.	An integer number between 1 and 4094. The value must be unique among all CVID variable values.
CVID10	A CE-VLAN ID value for tagged frames at UNI.	An integer number between 1 and 4094. The value must be unique among all CVID variable values.
CVID11	A CE-VLAN ID value for tagged frames at UNI.	An integer number between 1 and 4094. The value must be unique among all CVID variable values.
CVID12	A CE-VLAN ID value for tagged frames at UNI.	An integer number between 1 and 4094. The value must be unique among all CVID variable values.
CVID13	A CE-VLAN ID value for tagged frames at UNI.	An integer number between 1 and 4094. The value must be unique among all CVID variable values.
CVID14	A CE-VLAN ID value for tagged frames at UNI.	An integer number between 1 and 4094. The value must be unique among all CVID variable values.
CVID15	A CE-VLAN ID value for tagged frames at UNI.	An integer number between 1 and 4094. The value must be unique among all CVID variable values.
CVID16	A CE-VLAN ID value for tagged frames at UNI.	An integer number between 1 and 4094. The value must be unique among all CVID variable values.
CVID17	A CE-VLAN ID value for tagged frames at UNI.	An integer number between 1 and 4094. The value must be unique among all CVID variable values.
CVID18	A CE-VLAN ID value for tagged frames at UNI.	An integer number between 1 and 4094. The value must be unique among all CVID variable values.
CVID19	A CE-VLAN ID value for tagged frames at UNI.	An integer number between 1 and 4094. The value must be unique among all CVID variable values.
CVID20	A CE-VLAN ID value for tagged frames at UNI.	An integer number between 1 and 4094. The value must be unique among all CVID variable values.

String ID	Description	Possible Values
CVID21	A CE-VLAN ID value for tagged frames at UNI.	An integer number between 1 and 4094. The value must be unique among all CVID variable values.
CVID22	A CE-VLAN ID value for tagged frames at UNI.	An integer number between 1 and 4094. The value must be unique among all CVID variable values.
CVID23	A CE-VLAN ID value for tagged frames at UNI.	An integer number between 1 and 4094. The value must be unique among all CVID variable values.
CVID24	A CE-VLAN ID value for tagged frames at UNI.	An integer number between 1 and 4094. The value must be unique among all CVID variable values.
CVID25	A CE-VLAN ID value for tagged frames at UNI.	An integer number between 1 and 4094. The value must be unique among all CVID variable values.
CVID26	A CE-VLAN ID value for tagged frames at UNI.	An integer number between 1 and 4094. The value must be unique among all CVID variable values.
CVID27	A CE-VLAN ID value for tagged frames at UNI.	An integer number between 1 and 4094. The value must be unique among all CVID variable values.
CVID28	A CE-VLAN ID value for tagged frames at UNI.	An integer number between 1 and 4094. The value must be unique among all CVID variable values.
CVID29	A CE-VLAN ID value for tagged frames at UNI.	An integer number between 1 and 4094. The value must be unique among all CVID variable values.
CVID30	A CE-VLAN ID value for tagged frames at UNI.	An integer number between 1 and 4094. The value must be unique among all CVID variable values.
CVID31	A CE-VLAN ID value for tagged frames at UNI.	An integer number between 1 and 4094. The value must be unique among all CVID variable values.
CVID32	A CE-VLAN ID value for tagged frames at UNI.	An integer number between 1 and 4094. The value must be unique among all CVID variable values.
Multicast MAC Address	A MAC multicast address used for testing	Any valid MAC multicast address.
ENNI_Green_CoS1_IDs	A list of CoS ID identifiers applied at ENNI.	S-Tag PCP values between 0 and 7 or S-Tag PCP values between 0 and 7 and DEI set to 0. The value must be disjoint with other ENNI CoS IDs defined in this table.
ENNI_Yellow_CoS1_IDs	A list of CoS ID identifiers applied at ENNI.	The variable is set either to ENNI_Yellow_PCP_CoS1_IDs, if "S-Tag PCP Color Indication" = "Yes" or to ENNI_Yellow_DEI_CoS1_IDs, if "DEI Color Indication" = "Yes". The value must be disjoint with other ENNI CoS IDs defined in this table.
ENNI_Yellow_PCP_CoS1_IDs	A list of CoS ID identifiers applied at ENNI.	S-Tag PCP values between 0 and 7. The value must be disjoint with other ENNI CoS IDs defined in this table.

String ID	Description	Possible Values
ENNI_Yellow_DEI_CoS1_IDs	A list of CoS ID identifiers applied at ENNI.	S-Tag PCP values between 0 and 7 and DEI is set to 1. S-Tag PCP value must be equal to S-Tag PCP value of ENNI_Green_CoS1_IDs.
ENNI_Residual_CoS_IDs	A list of CoS ID identifiers applied at ENNI.	S-Tag PCP values between 0 and 7 and DEI bit. ENNI_Residual_CoS_IDs must be disjoint with other ENNI CoS IDs defined in this table.
UNI_Green_CoS1_IDs	A list of CoS ID identifiers applied at UNI.	C-Tag PCP values between 0 and 7 or DSCP values between 0 and 63. The value must be disjoint with other UNI CoS IDs defined in this table.
UNI_Yellow_CoS1_IDs	A list of CoS ID identifiers applied at UNI.	C-Tag PCP values between 0 and 7 or DSCP values between 0 and 63. The value must be disjoint with other UNI CoS IDs defined in this table..
UNI_Residual_CoS_IDs	A list of CoS ID identifiers applied at UNI.	C-Tag PCP values between 0 and 7 or DSCP values between 0 and 63. UNI_Residual_CoS_IDs must be disjoint with other UNI CoS IDs defined in this table.
EI_Green_CoS1_IDs	A list of CoS ID identifiers applied at an External Interface.	If the External Interface is UNI, the EI_Green_CoS1_IDs is equal to UNI_Green_CoS1_IDs, otherwise to ENNI_Green_CoS1_IDs.
EI_Yellow_CoS1_IDs	A list of CoS ID identifiers applied at an External Interface.	If the External Interface is UNI, the EI_Yellow_CoS1_IDs is equal to UNI_Yellow_CoS1_IDs, otherwise to ENNI_Yellow_CoS1_IDs.
CIR1	Non-zero Committed Information Rate applied in bandwidth profiles.	Positive value, expressed in bits/s.
EIR1	Non-zero Excess Information Rate applied in bandwidth profiles.	Positive value, expressed in bits/s.
CIR2	Non-zero Committed Information Rate applied in bandwidth profiles.	Positive value, expressed in bits/s. CIR2 = CIR/2 .
EIR2	Non-zero Excess Information Rate applied in bandwidth profiles.	Positive value, expressed in bits/s.
CBS1	Non-zero Committed Burst Size applied in bandwidth profiles.	Positive value, expressed in bytes. The recommended value for testing is at least 2*ENNI_MTU and can be different for a given testing scenario
EBS1	Excess Burst Size applied in bandwidth profiles.	Positive value, expressed in bytes. The recommended value for testing is at least 2*ENNI_MTU and can be different for a given testing scenario
BIR	Burst Information Rate	Line Rate * FrameSize / (Frame Size + 20) Rate in bits per second of frames transmitted, back-to-back with minimum inter-frame gap. BIR does not include the inter-frame gap, preamble nor start of frame delimiter.

### 5.4.3 ENNI configuration

The ENNI configuration used by the ATS is given in the tables below. The Table 9 specifies the entire configuration of ENNI1, which is used in a different test topology as shown in Figure 2, Figure 3, Figure 4 and Figure 5. The configuration of other ENNIs is specified only for Service Attributes which configuration is different than for ENNI1. If an ENNI configuration table does not specify a Service Attribute, the configuration of that Service Attribute should be considered as specified for ENNI1.

The "Link OAM" capability is disabled on ENNI1 and ENNI2.

**Table 9: ENNI1**

Attribute Name	Description	Value
Operator ENNI Identifier	An identifier for the ENNI intended for management purposes	"ENNI1"
Physical Layer	The physical layer of the links supporting the ENNI	ENNI_PHY
Frame Format	The format of the PDUs at the ENNI	Frame formats as specified in Section 7.1.3 of [MEF 26]
Number of Links	The number of physical links in the ENNI	1
Protection Mechanism	The method for protection, if any, against a failure	"none"
ENNI Maximum Transmission Unit Size	The maximum length ENNI Frame in bytes allowed at the ENNI	"ENNI_MTU"
End Point Map	The map that associates each ENNI S-Tag Frame with an End Point	Test Topology1: ENNI1 End Point Map1;  Test Topology 2: ENNI1 End Point Map2;  Test Topology 3:ENNI1 End Point Map3 and ENNI1 End Point Map1;  Test Topology 4: ENNI1 End Point Map4 and ENNI1 End Point Map2;  Test Topology 5: ENNI1 End Point Map1 and ENNI1 End Point Map2 and ENNI1 End Point Map5;
Maximum Number of OVCs	The maximum number of OVCs that the Operator can support at the ENNI	OVC_Max_Number_ENNI
Maximum Number of OVC End Points per OVC	The maximum number of OVC End Points that the Operator can support at the ENNI for an OVC.	1

**Table 10: ENNI2**

Attribute Name	Description	Value
Operator ENNI Identifier	An identifier for the ENNI intended for management purposes	"ENNI2"
End Point Map	The map that associates each S-Tagged ENNI Frame with an End Point	Test Topology 2: ENNI2 End Point Map1; Test Topology 4: ENNI2 End Point Map2 Test Topology 5: ENNI2 End Point Map1 and ENNI2 End Point Map3

**Table 11: ENNI3**

Attribute Name	Description	Value
Operator ENNI Identifier	An identifier for the ENNI intended for management purposes	"ENNI3"
ENNI Maximum Transmission Unit Size	The maximum length ENNI Frame in bytes allowed at the ENNI	1526
Protection Mechanism	The method for protection, if any, against a failure	"Link Aggregation"
Number of Links	The number of physical links in the ENNI	2
End Point Map	The map that associates each S-Tagged ENNI Frame with an End Point	ENNI3 End Point Map1

**Table 12: ENNI4**

Attribute Name	Description	Value
Operator ENNI Identifier	An identifier for the ENNI intended for management purposes	"ENNI4"
End Point Map	The map that associates each S-Tagged ENNI Frame with an End Point	ENNI4 End Point Map1

The tables below provide the ENNI End Point maps used in the ENNI configuration tables above.

ENNI1 End Point Map1 is used for Test Topology 1. It lists End Points on ENNI1 for point-to-point OVCs or multipoint-to-multipoint OVCs with multiple Endpoints on ENNI1 and a single End Point a UNI.

**Table 13: ENNI1 End Point Map1**

SVID	ENNI End Point	Type
SVID1	ENNI1_OVC1_End_Point_1	OVC End Point
SVID5	ENNI1_OVC3_End_Point_1 <b>Error! Reference source not found.</b>	OVC End Point
SVID6	ENNI1_OVC4_End_Point_1	OVC End Point
SVID18	ENNI1_OVC14_End_Point_1	OVC End Point
SVID21	ENNI1_OVC17_End_Point_1	OVC End Point
SVID23	ENNI1_OVC19_End_Point_1	OVC End Point
SVID25	ENNI1_OVC21_End_Point_1	OVC End Point
SVID27	ENNI1_OVC23_End_Point_1	OVC End Point
SVID28	ENNI1_OVC24_End_Point_1	OVC End Point
SVID30	ENNI1_OVC26_End_Point_1	OVC End Point
SVID34	ENNI1_OVC30_End_Point_1	OVC End Point
SVID36	ENNI1_OVC31_End_Point_1	OVC End Point
SVID37	ENNI1_OVC32_End_Point_1	OVC End Point
SVID44	ENNI1_OVC34_End_Point_1	OVC End Point
SVID45	ENNI1_OVC29_End_Point_1	OVC End Point

ENNI1 End Point Map2 is used for Test Topology 2. It lists End Points on ENNI1 for point-to-point OVCs with a single End Point.on ENN1 and another ENNI.

**Table 14: ENNI1 End Point Map2**

SVID	ENNI End Point	Type
SVID2	ENNI1_OVC2_End_Point_1	OVC End Point

SVID	ENNI End Point	Type
SVID9	ENNI1_OVC7_End_Point_1	OVC End Point
SVID32	ENNI1_OVC28_End_Point_1	OVC End Point

ENNI1 End Point Map3 is used for Test Topology 3. It lists End Points on ENNI1 for multipoint-to-multipoint OVCs that associate ENNI1, and two UNIs.

**Table 15: ENNI1 End Point Map3**

SVID	ENNI End Point	Type
SVID7	ENNI1_OVC5_End_Point_1	OVC End Point
SVID8	ENNI1_OVC6_End_Point_1	OVC End Point

ENNI1 End Point Map4 is used for Test Topology 4. It lists End Points on ENNI1 for multipoint-to-multipoint OVCs that associate ENNI1, and two other ENNIs.

**Table 16: ENNI1 End Point Map4**

SVID	ENNI End Point	Type
SVID11	ENNI1_OVC8_End_Point_1	OVC End Point

ENNI1 End Point Map5 is used for Test Topology 5. It lists End Points on ENNI1 for multipoint-to-multipoint OVCs that associate ENNI1, another ENNI, and an UNI.

**Table 17: ENNI1 End Point Map5**

SVID	ENNI End Point	Type
SVID46	ENNI1_OVC35_End_Point_1	OVC End Point
SVID3	ENNI1_OVC36_End_Point_1	OVC End Point

ENNI2 End Point Map1 is used for Test Topology 2. It lists End points on ENNI2 for point-to-point OVCs that associate ENNI2 and an other ENNI.

**Table 18: ENNI2 End Point Map1**

SVID	ENNI End Point	Type
SVID2	ENNI2_OVC2_End_Point_1	OVC End Point
SVID10	ENNI2_OVC7_End_Point_1	OVC End Point
SVID33	ENNI2_OVC28_End_Point_1	OVC End Point

ENNI2 End Point Map2 is used for Test Topology 4. It lists End Points on ENNI2 for multipoint-to-multipoint OVCs that associate ENNI2, and two other ENNIs.

**Table 19: ENNI2 End Point Map2**

SVID	ENNI End Point	Type
SVID12	ENNI2_OVC8_End_Point_1	OVC End Point

ENNI2 End Point Map3 is used for Test Topology 5. It lists End Points on ENNI2 for multipoint-to-multipoint OVCs that associate ENNI2, another ENNI and an UNI..

**Table 20: ENNI2 End Point Map3**

SVID	ENNI End Point	Type
SVID45	ENNI2_OVC35_End_Point_1	OVC End Point
SVID4	ENNI2_OVC36_End_Point_1	OVC End Point

ENNI3 End Point Map1 is used for Test Topology 1 (on ENNI3 the protection is enabled). It lists End Points on ENNI3 for point-to-point OVCs that associate ENNI3 and UNI1.

**Table 21: ENNI3 End Point Map1**

SVID	ENNI End Point	Type
SVID17	ENNI3_OVC13_End_Point_1	OVC End Point

ENNI4 End Point Map1 is used for Test Topology 4. It lists End Points on ENNI4 for multipoint-to-multipoint OVCs that associate ENNI4 and two other ENNIs.

**Table 22: ENNI4 End Point Map1**

SVID	ENNI End Point	Type
SVID12	ENNI4_OVC8_End_Point_1	OVC End Point

#### 5.4.4 OVC configuration

The OVC configuration used by the test suite is provided in the tables below. Table 23 specifies the entire configuration of OVC1. The configuration of other OVCs is specified only for OVC Service Attributes whose configuration is different from the OVC1 configuration. If an OVC configuration table does not specify a Service Attribute, the configuration of that Service Attribute should be considered as specified for OVC1.

**Table 23: OVC1**

Attribute Name	Description	Value
OVC Identifier	A string that uniquely identifies the OVC.	"OVC1"
OVC Type	An indication of the number of OVC End Points associated by the OVC.	"Point-to-Point"
OVC End Point List	A list of OVC End Point Identifiers	["ENNI1_OVC1_End_Point_1", "UNI1_OVC1_End_Point"]
Maximum Number of UNI OVC End Points	The bound on the number of OVC End Points at different UNIs that can be associated by the OVC.	1
Maximum Number of ENNI OVC End Points	The bound on the number of OVC End Points at ENNIs that can be associated by the OVC.	1
OVC Maximum Transmission Unit Size	The maximum length in bytes allowed in a frame mapped to an OVC End Point that is associated by the OVC.	OVC_MTU
CE-VLAN ID Preservation	A relationship between the format and certain field values of the frame at one External Interface and the format and certain field values of the corresponding frame at another External Interface that allows the CE-VLAN ID value of the Service Frame to be derived from the ENNI Frame and vice versa.	"No"
CE-VLAN CoS Preservation	A relationship between the format and certain field values of the frame at one External Interface and the format and certain field values of the corresponding frame at another External Interface that allows the CE-VLAN CoS value of the Service Frame to be derived from the ENNI Frame and vice versa.	"No"
S-VLAN ID Preservation	A relationship between the S-VLAN ID of a frame at one ENNI and the S-VLAN ID of the corresponding frame at another ENNI.	"No"
Color Forwarding	The relationship between the Color of an egress ENNI Frame and the Color of the corresponding ingress ENNI Frame or Service Frame.	"No"

Attribute Name	Description	Value
Unicast Service Frame Delivery	This attribute describes how ingress frames mapped to an OVC End Point with a unicast destination MAC address are delivered to the other External Interfaces with OVC End Points associated by the OVC.	"Deliver Unconditionally"
Multicast Service Frame Delivery	This attribute describes how ingress frames mapped to an OVC End Point with a multicast destination MAC address are delivered to the other External Interfaces with OVC End Points associated by the OVC.	"Deliver Unconditionally"
Broadcast Service Frame Delivery	This attribute describes how ingress frames mapped to an OVC End Point with the broadcast destination MAC address are delivered to the other External Interfaces with OVC End Points associated by the OVC.	"Deliver Unconditionally"

**Table 24: OVC2**

Attribute Name	Description	Value
OVC Identifier	A string that uniquely identifies the OVC.	"OVC2"
Maximum Number of UNI OVC End Points	The number of OVC End Points located at different UNIs.	0
Maximum Number of ENNI OVC End Points	The number of OVC End Points at ENNIs.	2
OVC End Point List	A list of OVC End Point Identifiers	["ENNI1_OVC2_End_Point_1", "ENNI2_OVC2_End_Point_1"]
CE-VLAN ID Preservation	A relationship between the format and certain field values of the frame at one External Interface and the format and certain field values of the corresponding frame at another External Interface that allows the CE-VLAN ID value of the Service Frame to be derived from the ENNI Frame and vice versa.	"Yes"
CE-VLAN CoS Preservation	A relationship between the format and certain field values of the frame at one External Interface and the format and certain field values of the corresponding frame at another External Interface that allows the CE-VLAN CoS value of the Service Frame to be derived from the ENNI Frame and vice versa.	"Yes"
S-VLAN ID Preservation	A relationship between the S-VLAN ID of a frame at one ENNI and the S-VLAN ID of the corresponding frame at another ENNI.	"No"



**Table 25: OVC3**

Attribute Name	Description	Value
OVC Identifier	A string that uniquely identifies the OVC.	"OVC3"
OVC End Point List	A list of OVC End Point Identifiers	[ENNI1_OVC3_End_Point_1, UNI2_OVC3_End_Point]

**Table 26: OVC4**

Attribute Name	Description	Value
OVC Identifier	A string that uniquely identifies the OVC.	"OVC4"
OVC End Point List	A list of OVC End Point Identifiers	[ENNI1_OVC4_End_Point_1, UNI5_OVC4_End_Point]

**Table 27: OVC5**

Attribute Name	Description	Value
OVC Identifier	A string that uniquely identifies the OVC.	"OVC5"
OVC Type	An indication of the number of OVC End Points associated by the OVC.	"Multipoint-to-Multipoint"
OVC End Point List	A list of OVC End Point Identifiers	["ENNI1_OVC5_End_Point_1", "UNI3_OVC5_End_Point", "UNI4_OVC5_End_Point",]
Maximum Number of UNI OVC End Points	The bound on the number of OVC End Points at different UNIs that can be associated by the OVC.	2
CE-VLAN ID Preservation	A relationship between the format and certain field values of the frame at one External Interface and the format and certain field values of the corresponding frame at another External Interface that allows the CE-VLAN ID value of the Service Frame to be derived from the ENNI Frame and vice versa.	"Yes"
CE-VLAN CoS Preservation	A relationship between the format and certain field values of the frame at one External Interface and the format and certain field values of the corresponding frame at another External Interface that allows the CE-VLAN CoS value of the Service Frame to be derived from the ENNI Frame and vice versa.	"Yes"

**Table 28: OVC6**

Attribute Name	Description	Value
OVC Identifier	A string that uniquely identifies the OVC.	"OVC6"
OVC Type	An indication of the number of OVC End Points associated by the OVC.	"Multipoint-to-Multipoint"
OVC End Point List	A list of OVC End Point Identifiers	["ENNI1_OVC6_End_Point_1", "UNI1_OVC6_End_Point", "UNI2_OVC6_End_Point",]

Attribute Name	Description	Value
Maximum Number of UNI OVC End Points	The bound on the number of OVC End Points at different UNIs that can be associated by the OVC.	2
CE-VLAN ID Preservation	A relationship between the format and certain field values of the frame at one External Interface and the format and certain field values of the corresponding frame at another External Interface that allows the CE-VLAN ID value of the Service Frame to be derived from the ENNI Frame and vice versa.	"Yes"

**Table 29: OVC7**

Attribute Name	Description	Value
OVC Identifier	A string that uniquely identifies the OVC.	"OVC7"
Maximum Number of UNI OVC End Points	The number of OVC End Points located at different UNIs.	0
Maximum Number of ENNI OVC End Points	The number of OVC End Points at ENNIs.	2
OVC End Point List	A list of OVC End Point Identifiers	["ENNI1_OVC7_End_Point_1", "ENNI2_OVC7_End_Point_1"]
S-VLAN ID Preservation	A relationship between the S-VLAN ID of a frame at one ENNI and the S-VLAN ID of the corresponding frame at another ENNI.	"No"

**Table 30: OVC8**

Attribute Name	Description	Value
OVC Identifier	A string that uniquely identifies the OVC.	"OVC8"
OVC Type	An indication of the number of OVC End Points associated by the OVC	"Multipoint-to-Multipoint"
Maximum Number of UNI OVC End Points	The number of OVC End Points located at different UNIs.	0
Maximum Number of ENNI OVC End Points	The number of OVC End Points at ENNIs.	3
OVC End Point List	A list of OVC End Point Identifiers	["ENNI1_OVC8_End_Point_1", "ENNI2_OVC8_End_Point_1", "ENNI4_OVC8_End_Point_1"]

Note: The " Unicast Frame Delivery", " Multicast Frame Delivery", and " Broadcast Frame Delivery " Service Attributes for OVC9 must be set to "Deliver Conditionally".

The ATS assumes that "Conditional Unicast Frame Delivery" is realized via MAC Address Learning, so the Operator MEN should support "MAC Address Learning" capability.

The ATS assumes that "Conditional Multicast Frame Delivery" and "Conditional Broadcast Frame Delivery" are realized via filtering of specific MAC addresses, so the Operator MEN should support "Frame Forwarding to Specific EI" capability. In case of OVC9 the ATS assumes that broadcast frames and multicast frames with the destination MAC address "Multicast MAC Address" are blocked towards ENNI2.

**Table 31: OVC10**

Attribute Name	Description	Value
OVC Identifier	A string that uniquely identifies the OVC.	"OVC10"
OVC End Point List	A list of OVC End Point Identifiers	["ENNI1_OVC10_End_Point_1", "UNI1_OVC10_End_Point"]

**Table 32: OVC11**

Attribute Name	Description	Value
OVC Identifier	A string that uniquely identifies the OVC.	"OVC11"
OVC End Point List	A list of OVC End Point Identifiers	[ENNI1_OVC11_End_Point_1, UNI1_OVC11_End_Point]

**Table 33: OVC12**

Attribute Name	Description	Value
OVC Identifier	A string that uniquely identifies the OVC.	"OVC12"
OVC End Point List	A list of OVC End Point Identifiers	["ENNI1_OVC12_End_Point_1", "UNI1_OVC12_End_Point"]

**Table 34: OVC13**

Attribute Name	Description	Value
OVC Identifier	A string that uniquely identifies the OVC.	"OVC13"
OVC End Point List	A list of OVC End Point Identifiers	["ENNI3_OVC13_End_Point_1", "UNI1_OVC13_End_Point"]

**Table 35: OVC14**

Attribute Name	Description	Value
OVC Identifier	A string that uniquely identifies the OVC.	"OVC14"
OVC End Point List	A list of OVC End Point Identifiers	["ENNI1_OVC14_End_Point_1"], "UNI1_OVC14_End_Point"]

**Table 36: OVC17**

Attribute Name	Description	Value
OVC Identifier	A string that uniquely identifies the OVC.	"OVC17"
OVC End Point List	A list of OVC End Point Identifiers	["ENNI1_OVC17_End_Point_1"], "UNI1_OVC17_End_Point"]

**Table 37: OVC19**

Attribute Name	Description	Value
OVC Identifier	A string that uniquely identifies the OVC.	"OVC19"
OVC End Point List	A list of OVC End Point Identifiers	["ENNI1_OVC19_End_Point_1"], "UNI1_OVC19_End_Point"]

**Table 38: OVC21**

Attribute Name	Description	Value
OVC Identifier	A string that uniquely identifies the OVC.	"OVC21"
OVC End Point List	A list of OVC End Point Identifiers	["ENNI1_OVC21_End_Point_1"], "UNI1_OVC21_End_Point"]

**Table 39: OVC23**

Attribute Name	Description	Value
OVC Identifier	A string that uniquely identifies the OVC.	"OVC23"
OVC End Point List	A list of OVC End Point Identifiers	["ENNI1_OVC23_End_Point_1"], "UNI1_OVC23_End_Point"]

**Table 40: OVC24**

Attribute Name	Description	Value
OVC Identifier	A string that uniquely identifies the OVC.	"OVC24"
OVC End Point List	A list of OVC End Point Identifiers	["ENNI1_OVC24_End_Point_1"], "UNI1_OVC24_End_Point"]

**Table 41: OVC26**

Attribute Name	Description	Value
OVC Identifier	A string that uniquely identifies the OVC.	"OVC26"
OVC End Point List	A list of OVC End Point Identifiers	["ENNI1_OVC26_End_Point_1"], "UNI1_OVC26_End_Point"]
Color Forwarding	The relationship between the Color of an egress ENNI Frame and the Color of the corresponding ingress ENNI Frame or Service Frame.	"Yes"

**Table 42: OVC28**

Attribute Name	Description	Value
OVC Identifier	A string that uniquely identifies the OVC.	"OVC28"
Maximum Number of UNI OVC End Points	The number of OVC End Points located at different UNIs.	0
Maximum Number of ENNI OVC End Points	The number of OVC End Points at ENNIs.	2
OVC End Point List	A list of OVC End Point Identifiers	["ENNI1_OVC28_End_Point_1"], "ENNI2_OVC28_End_Point_1"]
Color Forwarding	The relationship between the Color of an egress ENNI Frame and the Color of the corresponding ingress ENNI Frame or Service Frame.	"Yes"

**Table 43: OVC29**

Attribute Name	Description	Value
OVC Identifier	A string that uniquely identifies the OVC.	"OVC29"
OVC End Point List	A list of OVC End Point Identifiers	["ENNI1_OVC29_End_Point_1"], "UNI1_OVC29_End_Point"]

**Table 44: OVC31**

Attribute Name	Description	Value
OVC Identifier	A string that uniquely identifies the OVC.	"OVC31"
OVC End Point List	A list of OVC End Point Identifiers	["ENNI1_OVC31_End_Point_1"], "UNI1_OVC31_End_Point"]
CE-VLAN ID Preservation	A relationship between the format and certain field values of the frame at one External Interface and the format and certain field values of the corresponding frame at another External Interface that allows the CE-VLAN ID value of the Service Frame to be derived from the ENNI Frame and vice versa.	"Yes"

**Table 45: OVC32**

Attribute Name	Description	Value
OVC Identifier	A string that uniquely identifies the OVC.	"OVC32"
OVC End Point List	A list of OVC End Point Identifiers	["ENNI1_OVC32_End_Point_1", <b>Error! Reference source not found.</b> , "UNI1_OVC32_End_Point"]
Color Forwarding	The relationship between the Color of an egress ENNI Frame and the Color of the corresponding ingress ENNI Frame or Service Frame.	"Yes"

**Table 46: OVC34**

Attribute Name	Description	Value
OVC Identifier	A string that uniquely identifies the OVC.	"OVC34"
OVC End Point List	A list of OVC End Point Identifiers	["ENNI1_OVC34_End_Point_1"], "UNI1_OVC34_End_Point"]
CE-VLAN CoS ID Preservation	A relationship between the format and certain field values of the frame at one External Interface and the format and certain field values of the corresponding frame at another External Interface that allows the CE-VLAN ID value of the Service Frame to be derived from the ENNI Frame and vice versa.	"Yes"

**Table 47: OVC35**

Attribute Name	Description	Value
OVC Identifier	A string that uniquely identifies the OVC.	"OVC35"
OVC Type	An indication of the number of OVC End Points associated by the OVC.	"Multipoint-to-Multipoint"
OVC End Point List	A list of OVC End Point Identifiers	["ENNI1_OVC35_End_Point_1", "ENNI2_OVC35_End_Point_1", "UNI7_OVC35_End_Point",]

Attribute Name	Description	Value
Maximum Number of ENNI OVC End Points	The bound on the number of OVC End Points at ENNIs that can be associated by the OVC.	2
CE-VLAN ID Preservation	A relationship between the format and certain field values of the frame at one External Interface and the format and certain field values of the corresponding frame at another External Interface that allows the CE-VLAN ID value of the Service Frame to be derived from the ENNI Frame and vice versa.	"Yes"
CE-VLAN CoS Preservation	A relationship between the format and certain field values of the frame at one External Interface and the format and certain field values of the corresponding frame at another External Interface that allows the CE-VLAN CoS value of the Service Frame to be derived from the ENNI Frame and vice versa.	"Yes"

**Table 48: OVC36**

Attribute Name	Description	Value
OVC Identifier	A string that uniquely identifies the OVC.	"OVC36"
OVC Type	An indication of the number of OVC End Points associated by the OVC.	"Multipoint-to-Multipoint"
OVC End Point List	A list of OVC End Point Identifiers	["ENNI1_OVC36_End_Point_1", "ENNI2_OVC36_End_Point_1" "UNI1_OVC36_End_Point",]
Maximum Number of ENNI OVC End Points	The bound on the number of OVC End Points at ENNIs that can be associated by the OVC.	2
CE-VLAN ID Preservation	A relationship between the format and certain field values of the frame at one External Interface and the format and certain field values of the corresponding frame at another External Interface that allows the CE-VLAN ID value of the Service Frame to be derived from the ENNI Frame and vice versa.	"Yes"
CE-VLAN CoS Preservation	A relationship between the format and certain field values of the frame at one External Interface and the format and certain field values of the corresponding frame at another External Interface that allows the CE-VLAN CoS value of the Service Frame to be derived from the ENNI Frame and vice versa.	"Yes"

### 5.4.5 OVC End Point per ENNI configuration

The OVC End Point per ENNI configuration used by the test suite is given in tables below. The Table 49 specify entire configuration of ENNI1\_OVC1\_End\_Point\_1. The configuration of other OVC End Points per ENNI is specified only for Service Attributes which

configuration is different than for ENNI1\_OVC1\_End\_Point\_1. If a configuration table does not specify a Service Attribute, the configuration of that Service Attribute should be considered as specified for ENNI1\_OVC1\_End\_Point\_1.

**Table 49: ENNI1\_OVC1\_End\_Point\_1**

Attribute Name	Description	Value
OVC End Point Identifier	An identifier for the OVC End Point, which is unique across the Operator MEN	"ENNI1_OVC1_End_Point_1"
Class of Service Identifiers	The way that a Class of Service is determined for ENNI Frames.	[<"BestEffort", "OVC", [all]>.]
Ingress Bandwidth Profile Per OVC End Point	Ingress policing by the Operator MEN on all ingress ENNI Frames mapped to the OVC End Point. The attribute specifies mapping between Bandwidth Profile instances and CoS Labels. The mapping is one-to-one mapping.	"No"
Ingress Bandwidth Profile Per ENNI Class of Service Identifier	Ingress policing by the Operator MEN on all ingress ENNI Frames with the Class of Service Identifier for the receiving Operator MEN. The attribute specifies mapping between Bandwidth Profile instances and CoS Labels. The mapping is one-to-one mapping.	"No"
Egress Bandwidth Profile Per End Point	Egress policing by the Operator MEN on all egress ENNI Frames mapped to the OVC End Point. The attribute specifies mapping between Bandwidth Profile instances and CoS Labels. The mapping is one-to-one mapping.	"No"
Egress Bandwidth Profile Per ENNI Class of Service Identifier	Egress policing by the Operator MEN on all egress ENNI Frames with the Class of Service Identifier for the receiving MEN. The attribute specifies mapping between Bandwidth Profile instances and CoS Labels. The mapping is one-to-one mapping.	"No"

**Table 50: ENNI1\_OVC2\_End\_Point\_1**

Attribute Name	Description	Value
OVC End Point Identifier	An identifier for the OVC End Point, which is unique across the Operator MEN	"ENNI1_OVC2_End_Point_1"

**Table 51: ENNI2\_OVC2\_End\_Point\_1**

Attribute Name	Description	Value
OVC End Point Identifier	An identifier for the OVC End Point, which is unique across the Operator MEN	"ENNI2_OVC2_End_Point_1"

**Table 52: ENNI1\_OVC3\_End\_Point\_1**

Attribute Name	Description	Value
OVC End Point Identifier	An identifier for the OVC End Point, which is unique across the Operator MEN	"ENNI1_OVC3_End_Point_1"
Class of Service Identifiers	The way that a Class of Service is determined for ENNI Frames.	[ <"BestEffort", "PCP", [0]>, <"Discard", "PCP", [1,2,3,4,5,6,7]>, ]
Ingress Bandwidth Profile Per OVC End Point	Ingress policing by the Operator MEN on all ingress ENNI Frames mapped to the OVC End Point. The attribute specifies mapping between Bandwidth Profile instances and CoS Labels. The mapping is one-to-one mapping.	[<CIR1,CBS1,0,0,0,1>, "BestEffort"]

**Table 53: ENNI1\_OVC4\_End\_Point\_1**

Attribute Name	Description	Value
OVC End Point Identifier	An identifier for the OVC End Point, which is unique across the Operator MEN	"ENNI1_OVC4_End_Point_1"
Class of Service Identifiers	The way that a Class of Service is determined for ENNI Frames.	[ <"BestEffort", "PCP", [0]>, <"Discard", "PCP", [1,2,3,4,5,6,7]>, ]
Ingress Bandwidth Profile Per OVC End Point	Ingress policing by the Operator MEN on all ingress ENNI Frames mapped to the OVC End Point. The attribute specifies mapping between Bandwidth Profile instances and CoS Labels. The mapping is one-to-one mapping.	[<<CIR1,CBS1,0,0,0,1>, "BestEffort">, <<0,0,0,0,0,1>, "Discard">, ]

**Table 54: ENNI1\_OVC5\_End\_Point\_1**

Attribute Name	Description	Value
OVC End Point Identifier	An identifier for the OVC End Point, which is unique across the Operator MEN	"ENNI1_OVC5_End_Point_1"

**Table 55: ENNI1\_OVC6\_End\_Point\_1**

Attribute Name	Description	Value
OVC End Point Identifier	An identifier for the OVC End Point, which is unique across the Operator MEN	"ENNI1_OVC6_End_Point_1"

**Table 56: ENNI1\_OVC7\_End\_Point\_1**

Attribute Name	Description	Value
OVC End Point Identifier	An identifier for the OVC End Point, which is unique across the Operator MEN	"ENNI1_OVC7_End_Point_1"



**Table 57: ENNI2\_OVC7\_End\_Point\_1**

Attribute Name	Description	Value
OVC End Point Identifier	An identifier for the OVC End Point, which is unique across the Operator MEN	"ENNI2_OVC7_End_Point_1"

**Table 58: ENNI1\_OVC8\_End\_Point\_1**

Attribute Name	Description	Value
OVC End Point Identifier	An identifier for the OVC End Point, which is unique across the Operator MEN	"ENNI1_OVC8_End_Point_1"

**Table 59: ENNI2\_OVC8\_End\_Point\_1**

Attribute Name	Description	Value
OVC End Point Identifier	An identifier for the OVC End Point, which is unique across the Operator MEN	"ENNI2_OVC8_End_Point_1"

**Table 60: ENNI4\_OVC8\_End\_Point\_1**

Attribute Name	Description	Value
OVC End Point Identifier	An identifier for the OVC End Point, which is unique across the Operator MEN	"ENNI4_OVC8_End_Point_1"

**Table 61: ENNI2\_OVC9\_End\_Point\_1**

Attribute Name	Description	Value
OVC End Point Identifier	An identifier for the OVC End Point, which is unique across the Operator MEN	"ENNI2_OVC9_End_Point_1"

**Table 62: ENNI4\_OVC9\_End\_Point\_1**

Attribute Name	Description	Value
OVC End Point Identifier	An identifier for the OVC End Point, which is unique across the Operator MEN	"ENNI4_OVC9_End_Point_1"

**Table 63: ENNI1\_OVC10\_End\_Point\_1**

Attribute Name	Description	Value
OVC End Point Identifier	An identifier for the OVC End Point, which is unique across the Operator MEN	"ENNI1_OVC10_End_Point_1"

**Table 64: ENNI1\_OVC11\_End\_Point\_1**

Attribute Name	Description	Value
OVC End Point Identifier	An identifier for the OVC End Point, which is unique across the Operator MEN	"ENNI1_OVC11_End_Point_1"
Class of Service Identifiers	The way that a Class of Service is determined for ENNI Frames.	[ < "BestEffort", [0]>, < "Discard", [1,2,3,4,5,6,7]>, ]

Attribute Name	Description	Value
Ingress Bandwidth Profile Per OVC End Point	Ingress policing by the Operator MEN on all ingress ENNI Frames mapped to the OVC End Point. The attribute specifies mapping between Bandwidth Profile instances and CoS Labels. The mapping is one-to-one mapping.	[<<CIR1,CBS1,0,0,0,1>, "BestEffort">]

**Table 65: ENNI1\_OVC12\_End\_Point\_1**

Attribute Name	Description	Value
OVC End Point Identifier	An identifier for the OVC End Point, which is unique across the Operator MEN	"ENNI1_OVC12_End_Point_1"
Class of Service Identifiers	The way that a Class of Service is determined for ENNI Frames.	[<"BestEffort", "PCP", [0]>, <"Discard", "PCP", [1,2,3,4,5,6,7]>]
Ingress Bandwidth Profile Per OVC End Point	Ingress policing by the Operator MEN on all ingress ENNI Frames mapped to the OVC End Point. The attribute specifies mapping between Bandwidth Profile instances and CoS Labels. The mapping is one-to-one mapping.	[<<CIR1,CBS1,0,0,0,1>, "BestEffort">, <<0,0,0,0,0,1>, "Discard">]

**Table 66: ENNI3\_OVC13\_End\_Point\_1**

Attribute Name	Description	Value
OVC End Point Identifier	An identifier for the OVC End Point, which is unique across the Operator MEN	"ENNI3_OVC13_End_Point_1"

**Table 67: ENNI1\_OVC14\_End\_Point\_1**

Attribute Name	Description	Value
OVC End Point Identifier	An identifier for the OVC End Point, which is unique across the Operator MEN	"ENNI1_OVC14_End_Point_1"
Class of Service Identifiers	The way that a Class of Service is determined for an ENNI Frame at each ENNI.	[ ENNI_Yellow_CoS1_IDs, ENNI_Green_CoS1_IDs, ENNI_Residual_CoS_IDs]
Ingress Bandwidth Profile Per Class of Service	Ingress policing by the Operator MEN on all ingress ENNI Frames mapped to the OVC End Point that have the given ENNI Class of Service Identifier. The attribute specifies mapping between Bandwidth Profile instances and CoS Labels. The mapping is one-to-one mapping.	CoS1:< CIR1,CBS1,0,0,0,1> CoS2:<0,0,0,0,0,1>
Egress Bandwidth Profile Per ENNI Class of Service Identifier	Egress policing by the Operator MEN on all egress ENNI Frames with the Class of Service Identifier for the receiving MEN. The attribute specifies mapping between Bandwidth Profile instances and CoS Labels. The mapping is one-to-one mapping.	CoS1:< CIR1,CBS1,0,0,0,1> CoS2:<0,0,0,0,0,1>

Class of Service Identifiers	The way that a Class of Service is determined for an ENNI Frame at each ENNI.	[ ENNI_Yellow_CoS1_IDs, ENNI_Green_CoS1_IDs, ENNI_Residual_CoS_IDs]
Ingress Bandwidth Profile Per Class of Service	Ingress policing by the Operator MEN on all ingress ENNI Frames mapped to the OVC End Point that have the given ENNI Class of Service Identifier. The attribute specifies mapping between Bandwidth Profile instances and CoS Labels. The mapping is one-to-one mapping.	CoS1:< CIR1,CBS1,0,0,1,1> CoS2:<0,0,0,0,1,1>
Egress Bandwidth Profile Per ENNI Class of Service Identifier	Egress policing by the Operator MEN on all egress ENNI Frames with the Class of Service Identifier for the receiving MEN. The attribute specifies mapping between Bandwidth Profile instances and CoS Labels. The mapping is one-to-one mapping.	CoS1:< CIR1,CBS1,0,0,1,1> CoS2:<0,0,0,0,1,1>

**Table 68: ENNI1\_OVC17\_End\_Point\_1**

Attribute Name	Description	Value
OVC End Point Identifier	An identifier for the OVC End Point, which is unique across the Operator MEN	"ENNI1_OVC17_End_Point_1"
Class of Service Identifiers	The way that a Class of Service is determined for an ENNI Frame at each ENNI.	[ ENNI_Yellow_CoS1_IDs, ENNI_Green_CoS1_IDs, ENNI_Residual_CoS_IDs]
Ingress Bandwidth Profile Per Class of Service	Ingress policing by the Operator MEN on all ingress ENNI Frames mapped to the OVC End Point that have the given ENNI Class of Service Identifier. The attribute specifies mapping between Bandwidth Profile instances and CoS Labels. The mapping is one-to-one mapping.	CoS1:<0,0,EIR1,EBS1,0,1> CoS2:<0,0,0,0,0,1>
Egress Bandwidth Profile Per ENNI Class of Service Identifier	Egress policing by the Operator MEN on all egress ENNI Frames with the Class of Service Identifier for the receiving MEN. The attribute specifies mapping between Bandwidth Profile instances and CoS Labels. The mapping is one-to-one mapping.	CoS1:<0,0, EIR1,EBS1,0,1> CoS2:<0,0,0,0,0,1>

**Table 69: ENNI1\_OVC19\_End\_Point\_1**

Attribute Name	Description	Value
OVC End Point Identifier	An identifier for the OVC End Point, which is unique across the Operator MEN	"ENNI1_OVC19_End_Point_1"
Ingress Bandwidth Profile Per ENNI Class of Service Identifier	Ingress policing by the Operator MEN on all ingress ENNI Frames with the Class of Service Identifier for the receiving Operator MEN. The attribute specifies mapping between Bandwidth Profile instances and CoS Labels. The mapping is one-to-one mapping.	"Yes"
Class of Service Identifiers	The way that a Class of Service is determined for an ENNI Frame at each ENNI.	[ ENNI_Yellow_CoS1_IDs, ENNI_Green_CoS1_IDs, ENNI_Residual_CoS_IDs]
Ingress Bandwidth Profile Per Class of Service	Ingress policing by the Operator MEN on all ingress ENNI Frames mapped to the OVC End Point that have the given ENNI Class of Service Identifier. The attribute specifies mapping between Bandwidth Profile instances and CoS Labels. The mapping is one-to-one mapping.	CoS1:< CIR1,CBS1, EIR1,EBS1,0,1> CoS2:<0,0,0,0,0,1>
Egress Bandwidth Profile Per ENNI Class of Service Identifier	Egress policing by the Operator MEN on all egress ENNI Frames with the Class of Service Identifier for the receiving MEN. The attribute specifies mapping between Bandwidth Profile instances and CoS Labels. The mapping is one-to-one mapping.	CoS1:< CIR1,CBS1, EIR1,EBS1,0,1> CoS2:<0,0,0,0,0,1>

**Table 70: ENNI1\_OVC21\_End\_Point\_1**

Attribute Name	Description	Value
OVC End Point Identifier	An identifier for the OVC End Point, which is unique across the Operator MEN	"ENNI1_OVC21_End_Point_1"

**Table 71: ENNI1\_OVC23\_End\_Point\_1**

Attribute Name	Description	Value
OVC End Point Identifier	An identifier for the OVC End Point, which is unique across the Operator MEN	"ENNI1_OVC23_End_Point_1"

**Table 72: ENNI1\_OVC24\_End\_Point\_1**

Attribute Name	Description	Value
OVC End Point Identifier	An identifier for the OVC End Point, which is unique across the Operator MEN	"ENNI1_OVC24_End_Point_1"

**Table 73: ENNI1\_OVC26\_End\_Point\_1**

Attribute Name	Description	Value
OVC End Point Identifier	An identifier for the OVC End Point, which is unique across the Operator MEN	"ENNI1_OVC26_End_Point_1"

Ingress Bandwidth Profile Per Class of Service	Ingress policing by the Operator MEN on all ingress ENNI Frames mapped to the OVC End Point that have the given ENNI Class of Service Identifier. The attribute specifies mapping between Bandwidth Profile instances and CoS Labels. The mapping is one-to-one mapping.	CoS1:< CIR1, CBS1, EIR1, EBS1,1,1> CoS2:<0,0,0,0,1,1>
Egress Bandwidth Profile Per ENNI Class of Service Identifier	Egress policing by the Operator MEN on all egress ENNI Frames with the Class of Service Identifier for the receiving MEN. The attribute specifies mapping between Bandwidth Profile instances and CoS Labels. The mapping is one-to-one mapping.	CoS1:< CIR1, CBS1, EIR1, EBS1,1,1> CoS2:<0,0,0,0,1,1>

**Table 74: ENNI1\_OVC28\_End\_Point\_1**

Attribute Name	Description	Value
OVC End Point Identifier	An identifier for the OVC End Point, which is unique across the Operator MEN	"ENNI1_OVC28_End_Point_1"
Ingress Bandwidth Profile Per ENNI Class of Service Identifier	Ingress policing by the Operator MEN on all ingress ENNI Frames with the Class of Service Identifier for the receiving Operator MEN. The attribute specifies mapping between Bandwidth Profile instances and CoS Labels. The mapping is one-to-one mapping.	"Yes"
Class of Service Identifiers	The way that a Class of Service is determined for an ENNI Frame at each ENNI.	[ ENNI_Yellow_CoS1_IDs, ENNI_Green_CoS1_IDs, ENNI_Residual_CoS_IDs]
Ingress Bandwidth Profile Per Class of Service	Ingress policing by the Operator MEN on all ingress ENNI Frames mapped to the OVC End Point that have the given ENNI Class of Service Identifier. The attribute specifies mapping between Bandwidth Profile instances and CoS Labels. The mapping is one-to-one mapping.	CoS1:< CIR1, CBS1, EIR1, EBS1,0,1> CoS2:<0,0,0,0,0,1>
Egress Bandwidth Profile Per ENNI Class of Service Identifier	Egress policing by the Operator MEN on all egress ENNI Frames with the Class of Service Identifier for the receiving MEN. The attribute specifies mapping between Bandwidth Profile instances and CoS Labels. The mapping is one-to-one mapping.	CoS1:< CIR1, CBS1, EIR1, EBS1,0,1> CoS2:<0,0,0,0,0,1>

**Table 75: ENNI2\_OVC28\_End\_Point\_1**

Attribute Name	Description	Value
OVC End Point Identifier	An identifier for the OVC End Point, which is unique across the Operator MEN	"ENNI2_OVC28_End_Point_1"
Ingress Bandwidth Profile Per ENNI Class of Service Identifier	Ingress policing by the Operator MEN on all ingress ENNI Frames with the Class of Service Identifier for the receiving Operator MEN. The attribute specifies mapping between Bandwidth Profile instances and CoS Labels. The mapping is one-to-one mapping.	"Yes"
Class of Service Identifiers	The way that a Class of Service is determined for an ENNI Frame at each ENNI.	[ ENNI_Yellow_CoS1_IDs, ENNI_Green_CoS1_IDs, ENNI_Residual_CoS_IDs]
Ingress Bandwidth Profile Per Class of Service	Ingress policing by the Operator MEN on all ingress ENNI Frames mapped to the OVC End Point that have the given ENNI Class of Service Identifier. The attribute specifies mapping between Bandwidth Profile instances and CoS Labels. The mapping is one-to-one mapping.	CoS1:< CIR1, CBS1, EIR1, EBS1,0,1> CoS2:<0,0,0,0,0,1>

Attribute Name	Description	Value
Egress Bandwidth Profile Per ENNI Class of Service Identifier	Egress policing by the Operator MEN on all egress ENNI Frames with the Class of Service Identifier for the receiving MEN. The attribute specifies mapping between Bandwidth Profile instances and CoS Labels. The mapping is one-to-one mapping.	CoS1:< CIR1, CBS1, EIR1, EBS1,0,1> CoS2:<0,0,0,0,0,1>

**Table 76: ENNI1\_OVC29\_End\_Point\_1**

Attribute Name	Description	Value
OVC End Point Identifier	An identifier for the OVC End Point, which is unique across the Operator MEN	"ENNI1_OVC29_End_Point_1"

**Table 77: ENNI1\_OVC31\_End\_Point\_1**

Attribute Name	Description	Value
OVC End Point Identifier	An identifier for the OVC End Point, which is unique across the Operator MEN	"ENNI1_OVC31_End_Point_1"

**Table 78: ENNI1\_OVC32\_End\_Point\_1**

Attribute Name	Description	Value
OVC End Point Identifier	An identifier for the OVC End Point, which is unique across the Operator MEN	"ENNI1_OVC32_End_Point_1"

**Table 79: ENNI1\_OVC34\_End\_Point\_1**

Attribute Name	Description	Value
OVC End Point Identifier	An identifier for the OVC End Point, which is unique across the Operator MEN	"ENNI1_OVC34_End_Point_1"

**Table 80: ENNI1\_OVC35\_End\_Point\_1**

Attribute Name	Description	Value
OVC End Point Identifier	An identifier for the OVC End Point, which is unique across the Operator MEN	"ENNI1_OVC35_End_Point_1"

**Table 81: ENNI2\_OVC35\_End\_Point\_1**

Attribute Name	Description	Value
OVC End Point Identifier	An identifier for the OVC End Point, which is unique across the Operator MEN	"ENNI2_OVC35_End_Point_1"

**Table 82: ENNI1\_OVC36\_End\_Point\_1**

Attribute Name	Description	Value
OVC End Point Identifier	An identifier for the OVC End Point, which is unique across the Operator MEN	"ENNI1_OVC36_End_Point_1"

**Table 83: ENNI2\_OVC36\_End\_Point\_1**

Attribute Name	Description	Value
OVC End Point Identifier	An identifier for the OVC End Point, which is unique across the Operator MEN	"ENNI2_OVC36_End_Point_1"

### 5.4.6 UNI configuration

The configuration of the UNI used by the ATS is given in Table 84 below. The Table 84 specify entire configuration of UNI1. The configuration of other UNIs is specified only for Service Attributes which configuration is different than for UNI1. If a configuration table does not specify a Service Attribute, the configuration of that Service Attribute should be considered as specified for UNI1.

**Table 84: UNI1**

Attribute Name	Description	Value
UNI Identifier	An identifier for the UNI, which is unique across the Operator MEN	"UNI1"
Physical Layer	The physical layer of the links supporting the UNI	UNI_PHY
MAC Layer	The format of the PDUs at the UNI	Frame formats as specified in Section 7.3 of [MEF 10.2]
UNI Maximum Transmission Unit Size	The maximum frame length in bytes allowed at the UNI	UNI_MTU
Service Multiplexing	This attribute indicates if more than one EVC can be configured on the UNI	"Yes"
CE-VLAN ID/EVC Map	The attribute specifies the mapping table of CE-VLAN IDs to the EVC at the UNI.	The subscriber frames for OVC services are mapped to OVCs as specified by "OVC End Point Map" End Point Service Attribute, e.g. Table 91.
Maximum Number of EVCs	The maximum number of EVCs supported at the ENNI.	EVC_Max_Number_UNI

**Table 85: UNI2**

Attribute Name	Description	Value
UNI Identifier	An identifier for the UNI, which is unique across the Operator MEN	"UNI2"
CE-VLAN ID/EVC Map	The attribute specifies the mapping table of CE-VLAN IDs to the EVC at the UNI.	The subscriber frames for OVC services are mapped to OVCs as specified by "OVC End Point Map" End Point Service Attribute, e.g. Table 91.



**Table 86: UNI3**

Attribute Name	Description	Value
UNI Identifier	An identifier for the UNI, which is unique across the Operator MEN	"UNI3"
Service Multiplexing	This attribute indicates if more than one EVC can be configured on the UNI	"No"
Maximum Number of EVCs	The maximum number of EVCs supported at the ENNI.	1

**Table 87: UNI4**

Attribute Name	Description	Value
UNI Identifier	An identifier for the UNI, which is unique across the Operator MEN	"UNI4"
Service Multiplexing	This attribute indicates if more than one EVC can be configured on the UNI	"No"
Maximum Number of EVCs	The maximum number of EVCs supported at the ENNI.	1

**Table 88: UNI5**

Attribute Name	Description	Value
UNI Identifier	An identifier for the UNI, which is unique across the Operator MEN	"UNI5"
CE-VLAN ID/EVC Map	The attribute specifies the mapping table of CE-VLAN IDs to the EVC at the UNI.	The subscriber frames for OVC services are mapped to OVCs as specified by "OVC End Point Map" End Point Service Attribute, e.g. Table 91.

**Table 89: UNI6**

Attribute Name	Description	Value
UNI Identifier	An identifier for the UNI, which is unique across the Operator MEN	"UNI6"
Service Multiplexing	This attribute indicates if more than one EVC can be configured on the UNI	"No"
Maximum Number of EVCs	The maximum number of EVCs supported at the ENNI.	1

**Table 90: UNI7**

Attribute Name	Description	Value
UNI Identifier	An identifier for the UNI, which is unique across the Operator MEN	"UNI6"
Service Multiplexing	This attribute indicates if more than one EVC can be configured on the UNI	"No"
Maximum Number of EVCs	The maximum number of EVCs supported at the ENNI.	1

#### 5.4.7 OVC per UNI configuration

The OVC per UNI configuration used by the test suite is given in Table 91 below.

The "Bundling", "Untagged frames at UNI", and "Tagged frames at UNI" capabilities must be supported and enabled on MEN in order to configure UNI1\_OVC1\_End\_Point. The configuration of other UNI End Points than UNI1\_OVC1\_End\_Point is specified in tables of the current section below the Table 91. These tables define only Service Attributes which configuration is different than for UNI1\_OVC1\_End\_Point. If a UNI End Point configuration table does not specify a Service Attribute, the configuration of that Service Attribute should be considered as specified for UNI1\_OVC1\_End\_Point.

**Table 91: UNI1\_OVC1\_End\_Point**

Attribute Name	Description	Value
UNI OVC Identifier	An identifier for the instance of the OVC at a UNI intended for management purposes	"UNI1_OVC1_End_Point"
OVC End Point Map	The CE-VLAN ID(s) that map to the OVC End Point at the UNI	[CVID1, CVID_Default]
Class of Service Identifiers	The way that a Class of Service is determined for a frame at each UNI	[ <"BestEffort", "OVC", [all]>, ]
Ingress Bandwidth Profile Per OVC End Point at a UNI	Ingress policing by the Operator MEN on all ingress Service Frames mapped to the OVC End Point	"No"
Ingress Bandwidth Profile Per Class of Service Identifier at a UNI	Ingress policing by the Operator on all ingress Service Frames with a given Class of Service Identifier	"No"
Egress Bandwidth Profile Per OVC End Point at a UNI	Egress policing by the Operator on all egress Service Frames mapped to the OVC End Point	"No"
Egress Bandwidth Profile Per Class of Service Identifier at a UNI	Egress policing by the Operator on all egress Service Frames with a given Class of Service Identifier	"No"
Color Mode	CM is a Bandwidth Profile parameter. The Color Mode parameter indicates whether the color-aware or color-blind property is employed by the Bandwidth Profile.	Color-Blind

**Table 92: UNI2\_OVC3\_End\_Point**

Attribute Name	Description	Value
UNI OVC Identifier	An identifier for the instance of the OVC at a UNI intended for management purposes	"UNI2_OVC3_End_Point"
OVC End Point Map	The CE-VLAN ID(s) that map to the OVC End Point at the UNI	[CVID31, CVID_Default]
Class of Service Identifiers	The way that a Class of Service is determined for Service Frames. The attribute value is OVC endpoint plus PCP. a list of the following values: <CoS Name, CoS ID values>.	[ <"BestEffort", [0]>, <"Discard", [1,2,3,4,5,6,7]>, ]
Ingress Bandwidth Profile Per OVC End Point at a UNI	Ingress policing by the Operator MEN on all ingress Service Frames mapped to the OVC End Point	"No"

**Table 93: UNI5\_OVC4\_End\_Point**

Attribute Name	Description	Value
UNI OVC Identifier	An identifier for the instance of the OVC at a UNI intended for management purposes	"UNI5_OVC4_End_Point"
OVC End Point Map	The CE-VLAN ID(s) that map to the OVC End Point at the UNI	[CVID2, CVID_Default]
Class of Service Identifiers	The way that a Class of Service is determined for UNI Frames. The attribute value is a list of the following values: <CoS Label, Color, CoS ID type, CoS ID values>. CoS Label represents an internal CoS label of a MEN.. CoS ID type is one of the following: OVC, PCP (C-Tag Priority Code Point), or DSCP. If CoS ID type is set to OVC, CoS ID values are set to [all].	[ <"BestEffort", ("DSCP", [0] OR "Non-IP <sup>2</sup> ")>, <"Discard", "DSCP", [1..63]>, ]
Ingress Bandwidth Profile Per OVC End Point at a UNI	Ingress policing by the Operator MEN on all ingress Service Frames mapped to the OVC End Point	"No"

**Table 94: UNI3\_OVC5\_End\_Point**

Attribute Name	Description	Value
UNI OVC Identifier	An identifier for the instance of the OVC at a UNI intended for management purposes	"UNI3_OVC5_End_Point"
OVC End Point Map	The CE-VLAN ID(s) that map to the OVC End Point at the UNI	[All CE-VLAN IDs]

**Table 95: UNI4\_OVC5\_End\_Point**

Attribute Name	Description	Value
UNI OVC Identifier	An identifier for the instance of the OVC at a UNI intended for management purposes	"UNI4_OVC5_End_Point"
OVC End Point Map	The CE-VLAN ID(s) that map to the OVC End Point at the UNI	[All CE-VLAN IDs]

**Table 96: UNI1\_OVC6\_End\_Point**

Attribute Name	Description	Value
UNI OVC Identifier	An identifier for the instance of the OVC at a UNI intended for management purposes	"UNI1_OVC6_End_Point"
OVC End Point Map	The CE-VLAN ID(s) that map to the OVC End Point at the UNI	[CVID3, CVID4]

**Table 97: UNI2\_OVC6\_End\_Point**

Attribute Name	Description	Value
UNI OVC Identifier	An identifier for the instance of the OVC at a UNI intended for management purposes	"UNI2_OVC6_End_Point"

<sup>2</sup> All non-IP packets and IP packets with DSCP set to 0 are mapped to "BestEffort" class

Attribute Name	Description	Value
OVC End Point Map	The CE-VLAN ID(s) that map to the OVC End Point at the UNI	[CVID5]

**Table 98: UNI1\_OVC10\_End\_Point**

Attribute Name	Description	Value
UNI OVC Identifier	An identifier for the instance of the OVC at a UNI intended for management purposes	"UNI1_OVC10_End_Point"
OVC End Point Map	The CE-VLAN ID(s) that map to the OVC End Point at the UNI	[CVID6]
Class of Service Identifiers	The way that a Class of Service is determined for UNI Frames. The attribute value is a list of the following values: <CoS Label, Color, CoS ID type, CoS ID values>. CoS Label represents an internal CoS label of a MEN. CoS ID type is one of the following: OVC, PCP (C-Tag Priority Code Point), or DSCP. If CoS ID type is set to OVC, CoS ID values are set to [all].	[ <"BestEffort", "OVC", [all]>, ]
Ingress Bandwidth Profile Per OVC End Point at a UNI	Ingress policing by the Operator MEN on all ingress Service Frames mapped to the OVC End Point	"No"

**Table 99: UNI1\_OVC11\_End\_Point**

Attribute Name	Description	Value
UNI OVC Identifier	An identifier for the instance of the OVC at a UNI intended for management purposes	"UNI1_OVC11_End_Point"
OVC End Point Map	The CE-VLAN ID(s) that map to the OVC End Point at the UNI	[CVID7]
Class of Service Identifiers	The way that a Class of Service is determined for UNI Frames. The attribute value is a list of the following values: <CoS Label, Color, CoS ID type, CoS ID values>. CoS Label represents an internal CoS label of a MEN.. CoS ID type is one of the following: OVC, PCP (C-Tag Priority Code Point), or DSCP. If CoS ID type is set to OVC, CoS ID values are set to [all].	[ <"BestEffort", "PCP", [0]>, <"Discard", "PCP", [1,2,3,4,5,6,7]>, ]
Ingress Bandwidth Profile Per OVC End Point at a UNI	Ingress policing by the Operator MEN on all ingress Service Frames mapped to the OVC End Point	"No"

**Table 100: UNI1\_OVC12\_End\_Point**

Attribute Name	Description	Value
UNI OVC Identifier	An identifier for the instance of the OVC at a UNI intended for management purposes	"UNI1_OVC12_End_Point"
OVC End Point Map	The CE-VLAN ID(s) that map to the OVC End Point at the UNI	[CVID8, CVID_Default]

Attribute Name	Description	Value
Class of Service Identifiers	The way that a Class of Service is determined for UNI Frames. The attribute value is a list of the following values: <CoS Label, Color, CoS ID type, CoS ID values>. CoS Label represents an internal CoS label of a MEN.. CoS ID type is one of the following: OVC, PCP (C-Tag Priority Code Point), or DSCP. If CoS ID type is set to OVC, CoS ID values are set to [all].	[ <"BestEffort", "DSCP", [0]>, <"Discard", "DSCP", [1..63]>, ]
Ingress Bandwidth Profile Per OVC End Point at a UNI	Ingress policing by the Operator MEN on all ingress Service Frames mapped to the OVC End Point	"No"

**Table 101: UNI1\_OVC13\_End\_Point**

Attribute Name	Description	Value
UNI OVC Identifier	An identifier for the instance of the OVC at a UNI intended for management purposes	"UNI1_OVC13_End_Point"
OVC End Point Map	The CE-VLAN ID(s) that map to the OVC End Point at the UNI	[CVID10]

**Table 102: UNI1\_OVC14\_End\_Point**

Attribute Name	Description	Value
UNI OVC Identifier	An identifier for the instance of the OVC at a UNI intended for management purposes	"UNI1_OVC14_End_Point"
OVC End Point Map	The CE-VLAN ID(s) that map to the OVC End Point at the UNI	[CVID11]

**Table 103: UNI1\_OVC17\_End\_Point**

Attribute Name	Description	Value
UNI OVC Identifier	An identifier for the instance of the OVC at a UNI intended for management purposes	"UNI1_OVC17_End_Point"
OVC End Point Map	The CE-VLAN ID(s) that map to the OVC End Point at the UNI	[CVID14]

**Table 104: UNI1\_OVC19\_End\_Point**

Attribute Name	Description	Value
UNI OVC Identifier	An identifier for the instance of the OVC at a UNI intended for management purposes	"UNI1_OVC19_End_Point"
OVC End Point Map	The CE-VLAN ID(s) that map to the OVC End Point at the UNI	[CVID16]

**Table 105: UNI1\_OVC21\_End\_Point**

Attribute Name	Description	Value
UNI OVC Identifier	An identifier for the instance of the OVC at a UNI intended for management purposes	"UNI1_OVC21_End_Point"
OVC End Point Map	The CE-VLAN ID(s) that map to the OVC End Point at the UNI	[CVID18]
Class of Service Identifiers	The way that a Class of Service is determined for UNI Frames. The attribute value is a list of the following values: <CoS Label, Color, CoS ID type, CoS ID values>. CoS Label represents an internal CoS label of a MEN. CoS ID type is one of the following: OVC, PCP (C-Tag Priority Code Point), or DSCP. If CoS ID type is set to OVC, CoS ID values are set to [all].	[UNI_Yellow_CoS1_IDs, UNI_Green_CoS1_IDs, UNI_Residual_CoS_IDs]
Ingress Bandwidth Profile Per Class of Service Identifier at a UNI	Ingress policing by the Operator MEN on all ingress Service Frames mapped to the OVC End Point The attribute specifies mapping between Bandwidth Profile instances and CoS Labels. The mapping is one-to-one mapping.	CoS1:< CIR1,CBS1,0,0,0,0> CoS2:<0,0,0,0,0,0>

**Table 106: UNI1\_OVC23\_End\_Point**

Attribute Name	Description	Value
UNI OVC Identifier	An identifier for the instance of the OVC at a UNI intended for management purposes	"UNI1_OVC23_End_Point"
OVC End Point Map	The CE-VLAN ID(s) that map to the OVC End Point at the UNI	[CVID20]

Attribute Name	Description	Value
Class of Service Identifiers	The way that a Class of Service is determined for UNI Frames. The attribute value is a list of the following values: <CoS Label, Color, CoS ID type, CoS ID values>. CoS Label represents an internal CoS label of a MEN. CoS ID type is one of the following: OVC, PCP (C-Tag Priority Code Point), or DSCP. If CoS ID type is set to OVC, CoS ID values are set to [all].	[UNI_Yellow_CoS1_IDs, UNI_Green_CoS1_IDs, UNI_Residual_CoS_IDs]
Ingress Bandwidth Profile Per Class of Service Identifier at a UNI	Ingress policing by the Operator MEN on all ingress Service Frames mapped to the OVC End Point The attribute specifies mapping between Bandwidth Profile instances and CoS Labels. The mapping is one-to-one mapping.	CoS1:< CIR1, CBS1,0,0,1,1> CoS2:<0,0,0,0,1,1>

Table 107: UNI1\_OVC24\_End\_Point

Attribute Name	Description	Value
UNI OVC Identifier	An identifier for the instance of the OVC at a UNI intended for management purposes	"UNI1_OVC24_End_Point"
OVC End Point Map	The CE-VLAN ID(s) that map to the OVC End Point at the UNI	[CVID21]
Class of Service Identifiers	The way that a Class of Service is determined for UNI Frames. The attribute value is a list of the following values: <CoS Label, Color, CoS ID type, CoS ID values>. CoS Label represents an internal CoS label of a MEN. CoS ID type is one of the following: OVC, PCP (C-Tag Priority Code Point), or DSCP. If CoS ID type is set to OVC, CoS ID values are set to [all].	[UNI_Yellow_CoS1_IDs, UNI_Green_CoS1_IDs, UNI_Residual_CoS_IDs]
Ingress Bandwidth Profile Per Class of Service Identifier at a UNI	Ingress policing by the Operator MEN on all ingress Service Frames mapped to the OVC End Point The attribute specifies mapping between Bandwidth Profile instances and CoS Labels. The mapping is one-to-one mapping.	CoS1:<0, 0, EIR1, EBS1,0,0> CoS2:<0,0,0,0,0,0>

Table 108: UNI1\_OVC26\_End\_Point

Attribute Name	Description	Value
UNI OVC Identifier	An identifier for the instance of the OVC at a UNI intended for management purposes	"UNI1_OVC26_End_Point"
OVC End Point Map	The CE-VLAN ID(s) that map to the OVC End Point at the UNI	[CVID23]

Attribute Name	Description	Value
Class of Service Identifiers	The way that a Class of Service is determined for UNI Frames. The attribute value is a list of the following values: <CoS Label, Color, CoS ID type, CoS ID values>. CoS Label represents an internal CoS label of a MEN. CoS ID type is one of the following: OVC, PCP (C-Tag Priority Code Point), or DSCP. If CoS ID type is set to OVC, CoS ID values are set to [all].	[UNI_Yellow_CoS1_IDs, UNI_Green_CoS1_IDs, UNI_Residual_CoS_IDs]
Ingress Bandwidth Profile Per Class of Service Identifier at a UNI	Ingress policing by the Operator MEN on all ingress Service Frames mapped to the OVC End Point The attribute specifies mapping between Bandwidth Profile instances and CoS Labels. The mapping is one-to-one mapping.	CoS1:< CIR1, CBS1, EIR1, EBS1,0,1> CoS2:<0,0,0,0,0,1>

**Table 109: UNI1\_OVC29\_End\_Point**

Attribute Name	Description	Value
UNI OVC Identifier	An identifier for the instance of the OVC at a UNI intended for management purposes	"UNI1_OVC29_End_Point"
OVC End Point Map	The CE-VLAN ID(s) that map to the OVC End Point at the UNI	[CVID25]
Class of Service Identifiers	The way that a Class of Service is determined for UNI Frames. The attribute value is a list of the following values: <CoS Label, Color, CoS ID type, CoS ID values>. CoS Label represents an internal CoS label of a MEN. CoS ID type is one of the following: OVC, PCP (C-Tag Priority Code Point), or DSCP. If CoS ID type is set to OVC, CoS ID values are set to [all].	[ <"Discard", "OVC", [all]>, ]
Ingress Bandwidth Profile Per OVC End Point at a UNI	Ingress policing by the Operator MEN on all ingress Service Frames mapped to the OVC End Point	"No"

**Table 110: UNI1\_OVC31\_End\_Point**

Attribute Name	Description	Value
UNI OVC Identifier	An identifier for the instance of the OVC at a UNI intended for management purposes	"UNI1_OVC31_End_Point"
OVC End Point Map	The CE-VLAN ID(s) that map to the OVC End Point at the UNI	[CVID27]

**Table 111: UNI1\_OVC32\_End\_Point**

Attribute Name	Description	Value
UNI OVC Identifier	An identifier for the instance of the OVC at a UNI intended for management purposes	"UNI1_OVC32_End_Point"



Attribute Name	Description	Value
OVC End Point Map	The CE-VLAN ID(s) that map to the OVC End Point at the UNI	[CVID28]
Class of Service Identifiers	The way that a Class of Service is determined for UNI Frames. The attribute value is a list of the following values: <CoS Label, Color, CoS ID type, CoS ID values>. CoS Label represents an internal CoS label of a MEN. CoS ID type is one of the following: OVC, PCP (C-Tag Priority Code Point), or DSCP. If CoS ID type is set to OVC, CoS ID values are set to [all].	[UNI_Yellow_CoS1_IDs, UNI_Green_CoS1_IDs, UNI_Residual_CoS_IDs]
Ingress Bandwidth Profile Per Class of Service Identifier at a UNI	Ingress policing by the Operator MEN on all ingress Service Frames mapped to the OVC End Point The attribute specifies mapping between Bandwidth Profile instances and CoS Labels. The mapping is one-to-one mapping.	CoS1:< CIR1, CBS1, EIR1, EBS1,0,1> CoS2:<0,0,0,0,1>

**Table 112: UNI1\_OVC34\_End\_Point**

Attribute Name	Description	Value
UNI OVC Identifier	An identifier for the instance of the OVC at a UNI intended for management purposes	"UNI1_OVC34_End_Point"
OVC End Point Map	The CE-VLAN ID(s) that map to the OVC End Point at the UNI	[CVID32]

**Table 113: UNI7\_OVC35\_End\_Point**

Attribute Name	Description	Value
UNI OVC Identifier	An identifier for the instance of the OVC at a UNI intended for management purposes	"UNI7_OVC35_End_Point"
OVC End Point Map	The CE-VLAN ID(s) that map to the OVC End Point at the UNI	[All CE-VLAN IDs]

**Table 114: UNI1\_OVC36\_End\_Point**

Attribute Name	Description	Value
UNI OVC Identifier	An identifier for the instance of the OVC at a UNI intended for management purposes	"UNI1_OVC36_End_Point"
OVC End Point Map	The CE-VLAN ID(s) that map to the OVC End Point at the UNI	[CVID26]

#### 5.4.8 Suggested Test Flow Configuration

In all test cases the tester must monitor frames on the External Interfaces and evaluate their format. In almost each test case a tester transmits test frames. Unless a test case procedure otherwise stipulates, a test flow may be configured using the suggested values as specified in Table 115, or any other reasonable values.

The terms “sent”, “transmitted” and “received” are relative to the tester unless otherwise specified.

**Table 115: Suggested Test Flow Configuration**

String ID	Description	Suggested Value
Frame Sizes <sup>3</sup>	MAC frame sizes of frames (without taking any C-tag or S-Tag into account) in bytes (with FCS)	[64, 128, 512, 1024]
PCP value in CoS ID	The default PCP value used in the test frames.	0
Flow Definition	Definition of the default unidirectional traffic flow per OVC and pair of Ethernet clients. The field "Value" defines the flow's frame sequence.	[Broadcast frames of "Frame Sizes", Multicast frames of "Frame Sizes", Unicast frames of "Frame Sizes"]
Frame Rate / Information Rate	The rate (in fps or in bits/s) of the test traffic	1 frame per 10ms
Number of Ethernet clients per External Interface and OVC	Number of Ethernet clients per External Interface connected over OVC	2
Flow Transmission Duration	The timer defines the transmission duration of the specified flow.	120 s
Sequence Numbers	Specifies whether the sequence numbers are used in the payload of the test frames. The sequence numbers are used in order to identify reordering, frame drop and duplicated frames.	"Yes"
Reordered Frames	Specifies if the tester accepts reordered frames on the receive side	"Yes"
Duplicated Frames	Specifies if the tester accepts duplicated frames on the receive side	"Yes"
Signature	A string located within frame payload that uniquely identifies the frame as belonging to this flow in a test step.	Not specified
ToleranceFactor	A factor (percentage) describing the accepted tolerance of the bandwidth profile (policing) implementation	2 %

**Table 116: Test frames A configuration**

String ID	Description	Default Value
CoS ID	The default CoS ID used in the test frames.	ENNI_Green_CoS1_IDs
Frame Rate / Information Rate	The rate (in fps or in bits/s) of the test traffic	0.5*CIR1
Signature	A string located within frame payload that uniquely identifies this flow in a test step.	Not specified

**Table 117: Test frames B configuration**

String ID	Description	Default Value
Default CoS ID	The default CoS ID used in the test frames.	ENNI_Yellow_CoS1_IDs
Frame Rate / Information Rate	The rate (in fps or in bits/s) of the test traffic	0.5*EIR1
Signature	A string located within frame payload that uniquely identifies this flow in a test step.	Not specified

<sup>3</sup> Tester can send untagged, priority tagged or C-tagged Service Frames at the UNI. Tester can send S-tagged only or C-tagged and S-tagged ENNI Frames at ENNI

### 5.4.9 Default Test Suite Configuration

Every test case shares a test suite specific configuration, which depends on the test method used by the test suite. Unless a test case procedure otherwise stipulates, a test case uses test suite specific configuration as specified in Table 118.

**Table 118: Default Test Suite configuration**

String ID	Description	Default Value
Test Case Execution Time	Every test case runs at most "Test Case Execution Time". The default value specified in this table may be redefined in a particular test case. At the beginning of every test case execution a timer with "Test Case Execution Time" is started. If this timer timeout the test case execution will be terminated. Usually the test case execution will be terminated before the "Test Case Execution" timeout by receiving of a pass or failure condition.	2*Flow Transmission Duration s
Ethernet Client MAC Address	The MAC address of a first emulated Ethernet client. This parameter will be specified for each emulated Ethernet client used for the test suite execution.	00:01:01:01:01:01
Ethernet Client MAC Address Step	This parameter is used to automatically generate MAC addresses of all emulated MAC clients. The MAC address of a particular client is the MAC address of the previous generated address plus the Ethernet Client MAC Address Step.	00:00:00:00:00:01
Multicast MAC Address	The multicast MAC address used during the test suite execution.	01:01:01:01:01:01

### 5.4.10 Default LACP Configuration

The following table defines the default configuration of Link Aggregation Group configured on the protected ENNI of the Operator MEN.

**Table 119: Default LACP Configuration**

String ID	Description	Value
Actor_Admin_Port_State.LACP_Activity	This Variable indicates the Activity control value with regard to this link. ([802.3 – 2005] section 43.4.7 and 43.4.2.2)	ACTIVE
Actor_Admin_Port_State.LACP_Timeout	This variable indicates the Timeout control value with regard to this link ([802.3 – 2005] section 43.4.7 and 43.4.2.2).	LONG
Actor_Admin_Port_State.LACP_Aggregation	This variable indicates that the System considers this link to be Aggregateable ([802.3 – 2005] section 43.4.7 and 43.4.2.2).	TRUE
Actor_Admin_Port_State.Synchronization	If TRUE, this link has been allocated to the correct Link Aggregation Group, the group has been associated with a compatible Aggregator, and the identify of the Link Aggregation Group is consistent with the System ID and operational Key information transmitted If FALSE, then this link is not in the right Aggregation ([802.3 – 2005] section 43.4.7 and 43.4.2.2.)	FALSE
Actor_Admin_Port_State.Collecting	TRUE means collection of incoming frames on this link is definitely enabled; i.e., collection is currently enabled and is not expected to be disabled in the absence of administrative changes or changes in received protocol information. Its value is otherwise FALSE. ([802.3 – 2005] section 43.4.7 and 43.4.2.2.)	FALSE

String ID	Description	Value
Actor_Admin_Port_State.Distributing	FALSE means distribution of outgoing frames on this link is definitely disabled; i.e., distribution is currently disabled and is not expected to be enabled in the absence of administrative changes or changes in received protocol information. ([802.3 – 2005] section 43.4.7 and 43.4.2.2.)	FALSE
Partner_Admin_Port_State.LACP_Activity	This Variable indicates the Activity control value with regard to this link. ([802.3 – 2005] section 43.4.7 and 43.4.2.2.)	PASSIVE
Partner_Admin_Port_State.LACP_Timeout	This variable indicates the Timeout control value with regard to this link ([802.3 – 2005] section 43.4.7 and 43.4.2.2).	LONG
Partner_Admin_Port_State.LACP_Aggregation	This variable indicates that the System considers this link to be Aggregateable ([802.3 – 2005] section 43.4.7 and 43.4.2.2).	TRUE
Partner_Admin_Port_State.Synchronization	If TRUE, this link has been allocated to the correct Link Aggregation Group, the group has been associated with a compatible Aggregator, and the identify of the Link Aggregation Group is consistent with the System ID and operational Key information transmitted If FALSE, then this link is not in the right Aggregation ([802.3 – 2005] section 43.4.7 and 43.4.2.2).	FALSE
Partner_Admin_Port_State.Collecting	TRUE means collection of incoming frames on this link is definitely enabled; i.e., collection is currently enabled and is not expected to be disabled in the absence of administrative changes or changes in received protocol information. Its value is otherwise FALSE ([802.3 – 2005] section 43.4.7 and 43.4.2.2.)	FALSE
Actor_Admin_Port_State.Distributing	FALSE means distribution of outgoing frames on this link is definitely disabled; i.e., distribution is currently disabled and is not expected to be enabled in the absence of administrative changes or changes in received protocol information ([802.3 – 2005] section 43.4.7 and 43.4.2.2)	FALSE
Partner_Admin_Key	Default value for the Partner's Key, assigned by administrator or System policy for use when the Partner's information is unknown or expired ([802.3 – 2005] section 43.4.7 and 43.4.2.2).	20
Actor_Admin_Aggregator_Key	The administrative Key value associated with the Aggregator ([802.3 – 2005] section 43.4.7 and 43.4.2.2).	40
Actor_Admin_Port_Key	The administrative value of Key assigned to this port by administrator or System policy ([802.3 – 2005] section 43.4.7 and 43.4.2.2).	Actor_Admin_Aggregator_Key
Actor_Port_Number	The port number assigned to the port ([802.3 – 2005] section 43.4.7 and 43.4.2.2).	1 for link of ENNI configured as Standby, 2 for link of ENNI configured as Active

### 5.4.11 LACP Configuration

Many test cases require the tester to send LACPDU's towards the LAG interfaces. Default values of the LACPDU fields are provided in the "LACPDU: (Default Configuration)" table below. The tables after the "LACPDU: (Default Configuration)" define LACPDU's that are used by the Tester in order to trigger a special event on the LACP instance, e.g. "LACPDU: (Request for FastMode)". These tables specify just the fields of a LACPDU that have different value than as specified by "LACPDU: (Default Configuration)".

Table 120: LACPDU (Default Configuration)

Segment	String ID	Description	Value
	Version Number	This identifies the LACP version; implementations conformant to this version of the standard carry the value 0x01 ([802.3 – 2005] section 43.4.2.2).	0x01
Actor Information TLV	Actor_System_Priority	The priority assigned to this System (by management or administration policy), encoded as an unsigned integer. ([802.3 – 2005] section 43.4.2.2).	0x0001
	Actor_System	The Actor's System ID, encoded as a MAC address ([802.3 – 2005] section 43.4.2.2).	01-01-01-01-01-01
	Actor_Key	The operational Key value assigned to the port by the Actor, encoded as an unsigned integer ([802.3 – 2005] section 43.4.2.2).	Partner_Admin_Key
	Actor_Port	The port number assigned to the port by the Actor (the System sending the PDU), encoded as an unsigned integer. ([802.3 – 2005] section 43.4.2.2).	1 for link of ENNI configured as Standby, 2 for link of ENNI configured as Active
	Actor_Port_Priority	The priority assigned to the port by the Actor (the System sending the PDU), encoded as an unsigned integer ([802.3 – 2005] section 43.4.2.2).	0x0001
	Actor_State.LACP_Activity	This flag indicates the Activity control value with regard to this link. ([802.3 – 2005] section 43.4.2.2)	ACTIVE
	Actor_State.LACP_Timeout	This flag indicates the Timeout control value with regard to this link ([802.3 – 2005] section 43.4.2.2).	LONG
	Actor_State.LACP_Aggregation	This flag indicates that the System considers this link to be Aggregateable ([802.3 – 2005] section 43.4.2.2).	TRUE
	Actor_State.Synchronization	If TRUE, this link has been allocated to the correct Link Aggregation Group, the group has been associated with a compatible Aggregator, and the identify of the Link Aggregation Group is consistent with the System ID and operational Key information transmitted If FALSE, then this link is not in the right Aggregation ([802.3 – 2005] section 43.4.2.2).	FALSE
	Actor_State.Collecting	TRUE means collection of incoming frames on this link is definitely enabled; i.e., collection is currently enabled and is not expected to be disabled in the absence of administrative changes or changes in received protocol information. Its value is otherwise FALSE ([802.3 – 2005] section 43.4.2.2).	FALSE
	Actor_State.Distributing	FALSE means distribution of outgoing frames on this link is definitely disabled; i.e., distribution is currently disabled and is not expected to be enabled in the absence of administrative changes or changes in received protocol information ([802.3 – 2005] section 43.4.2.2).	FALSE
	Actor_State.Defaulted	This flag indicates that the Actor's Receive machine is using Defaulted operational Partner information, administratively configured for the Partner. If FALSE, the operational Partner information in use has been received in a LACPDU ([802.3 – 2005] section 43.4.2.2)	FALSE
Actor_State.Expired	If TRUE, this flag indicates that the Actor's Receive machine is in the EXPIRED state; if FALSE, this flag indicates that the Actor Receive machine is not in the EXPIRED state ([802.3 – 2005] section 43.4.2.2).	FALSE	
Partner Information TLV	Partner_System_Priority	The priority assigned to this System (by management or administration policy), encoded as an unsigned integer ([802.3 – 2005] section 43.4.2.2).	0x0001

Segment	String ID	Description	Value
	Partner_System	The Partner's System ID, encoded as a MAC address ([802.3 – 2005] section 43.4.2.2).	01-01-01-01-01-02
	Partner_Key	The operational Key value assigned to the port by the Partner, encoded as an unsigned integer ([802.3 – 2005] section 43.4.2.2).	Actor_Admin_Aggregationor_Key
	Partner_Port_Priority	The priority assigned to the port by the Partner, encoded as an unsigned integer ([802.3 – 2005] section 43.4.2.2).	0x0001
	Partner_Port	([802.3 – 2005] section 43.4.2.2).	0x0001
	Partner_State.LACP_Activity	This flag indicates the Activity control value with regard to this link. ([802.3 – 2005] section 43.4.2.2).	ACTIVE
	Partner_State.LACP_Timeout	This flag indicates the Timeout control value with regard to this link ([802.3 – 2005] section 43.4.2.2).	LONG
	Partner_State.LACP_Aggregation	This flag indicates that the System considers this link to be Aggregateable ([802.3 – 2005] section 43.4.2.2).	TRUE
	Partner_State.Synchronization	If TRUE, this link has been allocated to the correct Link Aggregation Group, the group has been associated with a compatible Aggregator, and the identify of the Link Aggregation Group is consistent with the System ID and operational Key information transmitted If FALSE, then this link is not in the right Aggregation ([802.3 – 2005] section 43.4.2.2).	FALSE
	Partner_State.Collecting	TRUE means collection of incoming frames on this link is definitely enabled; i.e., collection is currently enabled and is not expected to be disabled in the absence of administrative changes or changes in received protocol information. Its value is otherwise FALSE ([802.3 – 2005] section 43.4.2.2).	FALSE
	Partner_State.Distributing	FALSE means distribution of outgoing frames on this link is definitely disabled; i.e., distribution is currently disabled and is not expected to be enabled in the absence of administrative changes or changes in received protocol information ([802.3 – 2005] section 43.4.2.2).	FALSE
	Partner_State.Defaulted	This flag indicates that the Actor's Receive machine is using Defaulted operational Partner information, administratively configured for the Partner. If FALSE, the operational Partner information in use has been received in a LACPDU ([802.3 – 2005] section 43.4.2.2).	FALSE
	Partner_State.Expired	If TRUE, this flag indicates that the Actor's Receive machine is in the EXPIRED state; if FALSE, this flag indicates that the Actor Receive machine is not in the EXPIRED state ([802.3 – 2005] section 43.4.2.2).	FALSE
	CollectorMaxDelay	This field contains the value of CollectorMaxDelay of the station transmitting the LACPDU ([802.3 – 2005] section 43.4.2.2).	0

**Table 121: LACPDU (Request for Fast Mode)**

String ID	Description	Value
Actor_State.LACP_Timeout	Some tests request the tester to send a LACPDU based on the default configuration with change in the value of this flag	SHORT

**Table 122: LACPDU (Request for detaching)**

String ID	Description	Value
Actor_Key	Some tests request the tester to send a LACPDU based on the default configuration with change in the value of this flag	Actor_Admin_Aggregationor_Key + 1

**Table 123: LACPDU (Request for disabling Collection and Distribution)**

String ID	Description	Value
Actor_State.Synchronization	Some tests request the tester to send a LACPDU based on the default configuration with change in the value of these flags	FALSE
Actor_State.Collecting		FALSE
Actor_State.Distributing		FALSE

**Table 124: LACPDU (Request for enabling Collection/disabling Distribution)**

String ID	Description	Value
Actor_State.Synchronization	Some tests request the tester to send a LACPDU based on the default configuration with change in the value of these flags	TRUE
Actor_State.Collecting		FALSE
Actor_State.Distributing		FALSE

**Table 125: LACPDU (Request for enabling Distribution)**

String ID	Description	Value
Actor_State.Synchronization	Some tests request the tester to send a LACPDU based on the default configuration with change in the value of these flags	TRUE
Actor_State.Collecting		TRUE
Actor_State.Distributing		FALSE

**Table 126: LACPDU (Request for informing current states)**

String ID	Description	Value
Partner_State.LACP_Activity	Some tests request the tester to send a LACPDU based on the default configuration with change in the value of this flag	PASSIVE

**Table 127: LACPDU (Request for being Individual)**

String ID	Description	Value
Partner_State.LACP_Aggregation	Some tests request the tester to send a LACPDU based on the default configuration with change in the value of this flag	FALSE

The following tables define the test traffic to be sent by the Tester towards the Operator MEN for different test cases.

**Table 128: Flow Definition1 (Default traffic flow definition)**

String ID	Description	Value
Traffic Flow Definition 1	This is the default configuration of traffic flow.	Test frames as defined in "Flow Definition" in Suggested Test Flow Configuration.

**Table 129: Flow Definition2 (Traffic flow for negative test cases)**

String ID	Description	Value
Traffic Flow Definition 2	Special unidirectional traffic flow at the protected ENNI for negative test cases	Frames with Invalid Slow Protocol subtype values defined in [802.3 – 2005] Table 43B–2, LACPDU, Marker PDU, OAM PDU, and test frames as defined in "Flow Definition" in Suggested Test Flow Configuration.

The following table references default LACP timer values used by the test suite, as defined in [802.3 – 2005], section 43.4.4.

**Table 130: LACP timers**

String ID	Description	Value
Fast_Periodic_Time	The number of seconds between periodic transmissions using Short Timeouts ([802.3 – 2005] section 43.4.4)	1 s
Slow_Periodic_Time	The number of seconds between periodic transmissions using Long Timeouts ([802.3 – 2005] section 43.4.4)	30 s
Short_Timeout_Time	The number of seconds before invalidating received LACPDU information when using Short Timeouts (3 x Fast_Periodic_Time) ([802.3 – 2005] section 43.4.4)	3 s
Long_Timeout_Time	The number of seconds before invalidating received LACPDU information when using Long Timeouts (3 x Slow_Periodic_Time) ([802.3 – 2005] section 43.4.4)	90 s

The following table defines implementation-specific timing values used by the test suite. The provided values do not represent constants, but are implementation-specific and must be determined and filled in before executing the test suite.

**Table 131: LACP-specific Parameters**

Parameter	Description	Value
Reboot time	The amount of time the LACP instance needs to perform a full Reboot operation	300 s
LACPDU listen time	The maximum time interval required by the LACP instance to generate a LACP/Marker PDU	3 s
LACP process time	The time required by a LACP instance to process the received information.	1 s



## 5.5 Template for Abstract Test Cases

The table below defines a format for the test cases in current ATS.

**Table 132: Abstract Test Cases template**

ABSTRACT TEST CASES FOR ENNI PHASE 1	
Test Case ID	Concatenation of the group name, requirement number and an ID, which is unique within group name and the requirement, e.g. ENNI_ATTRIBUTES.R9.1
Reference Document Source	Reference document and section, e.g. MEF 26, Section 9.1
Test Status	Mandatory, Conditional Mandatory, Optional
Requirement	Service requirement, e.g. R9: An ingress ENNI Frame that is invalid as defined in Clause 3.4 of [802.3 – 2005] MUST be discarded by the receiving Operator MEN.
Test Purpose	The short description of the test. E.g. Verify the single-tagged and double-tagged frame forwarding for subscriber frames at ENNI by sending C-tagged and untagged frames at UNI and single-tagged and double-tagged frames at ENNI.
Conditions	Feature/capability settings (e.g. service attributes, supported features) of the Operator MEN needed to perform this test case.
Test Topology/OVC	A picture of the minimum required test topology for execution and a reference to OVC and OVC End Point configuration.
Test Procedure	The detailed test instructions. The test frames specified in the test procedure relate to the OVCs specified in "Conditions".
Expected Results	A list of expected results. If all of the test results match the expected results list, the test verdict is PASS, if some of the results don't match the list, the test verdict is FAIL, and otherwise the test verdict is INCONCLUSIVE.
Verdict	Possible verdict of the test case. A verdict can be one of the following: PASS, or INCONCLUSIVE

## 6 Test Group: Foundation

6.1 PHY of ENNI Links

ABSTRACT TEST CASES FOR ENNI PHASE 1									
Test Case ID	ENNI_ATTRIBUTES.R5.1								
Reference Document Source	MEF 26, R5								
Test Status	Mandatory								
Requirement	Each link in an ENNI MUST be one of the following physical layers in full duplex mode as defined in [IEEE 802.3 – 2005]: 1000Base-SX, 1000Base-LX, 1000Base T, 10GBASE-SR, 10GBASE-LX4, 10GBASE-LR, 10GBASE-ER, 10GBASE-SW, 10GBASE-LW, 10GBASE-EW.								
Test Purpose	Verify that all ENNI links operate in full duplex mode and the physical type is one of the following: 1000Base-SX, 1000Base-LX, 1000Base T, 10GBASE-SR, 10GBASE-LX4, 10GBASE-LR, 10GBASE-ER, 10GBASE-SW, 10GBASE-LW, 10GBASE-EW.								
Conditions	none								
Test Topology/OVC	<table border="1" style="margin-top: 10px;"> <thead> <tr> <th>S-VID</th> <th>End Point ID</th> </tr> </thead> <tbody> <tr> <td>SVID2</td> <td>ENNI1_OVC2_End_Point_1</td> </tr> </tbody> </table> <table border="1" style="margin-top: 10px;"> <thead> <tr> <th>S-VID</th> <th>End Point ID</th> </tr> </thead> <tbody> <tr> <td>SVID2</td> <td>ENNI2_OVC2_End_Point_1</td> </tr> </tbody> </table>	S-VID	End Point ID	SVID2	ENNI1_OVC2_End_Point_1	S-VID	End Point ID	SVID2	ENNI2_OVC2_End_Point_1
S-VID	End Point ID								
SVID2	ENNI1_OVC2_End_Point_1								
S-VID	End Point ID								
SVID2	ENNI2_OVC2_End_Point_1								
Test Procedure	Tester transmits S-Tag test frames at each ENNI, that are mapped to OVC2.								
Expected Results	The physical link on each ENNI is operational The physical link on each ENNI is one of the following types: 1000Base-SX, 1000Base-LX, 1000Base T, 10GBASE-SR, 10GBASE-LX4, 10GBASE-LR, 10GBASE-ER, 10GBASE-SW, 10GBASE-LW, 10GBASE-EW The physical link of each ENNI operates in full duplex mode. All test frames sent at ENNI1 are received at ENNI2. All test frames sent at ENNI2 are received at ENNI1.								
Verdict	PASS, FAIL, or INCONCLUSIVE								

6.2 Single-tagged Frames at ENNI

ABSTRACT TEST CASES FOR ENNI PHASE 1									
Test Case ID	ENNI_ATTRIBUTES.R7.1								
Reference Document Source	MEF 26, R7, R6								
Test Status	Mandatory								
Requirement	R6: Each ENNI Frame MUST have the standard Ethernet format with one of the tag configurations specified in Table 3 of [MEF 26]. [DA = Destination Address, SA = Source Address, ET = Ethertype/Length, S-Tag with Tag Protocol Identification Field (TPID) = 0x88A8.] R7: An S-Tag MUST have the format specified in Sections 9.5 and 9.7 of [IEEE 802.1ad].								
Test Purpose	Verify the S-Tag frame format at ENNI1 by sending S-Tag frames at both ENNI1 and ENNI2								
Conditions	Number of ENNI OVC End Points > 1								
Test Topology/OVC	<table border="1" style="display: inline-table; margin-right: 20px;"> <thead> <tr> <th>S-VID</th> <th>End Point ID</th> </tr> </thead> <tbody> <tr> <td>SVID2</td> <td>ENNI1_OVC2_End_Point_1</td> </tr> </tbody> </table> <table border="1" style="display: inline-table;"> <thead> <tr> <th>S-VID</th> <th>End Point ID</th> </tr> </thead> <tbody> <tr> <td>SVID2</td> <td>ENNI2_OVC2_End_Point_1</td> </tr> </tbody> </table>	S-VID	End Point ID	SVID2	ENNI1_OVC2_End_Point_1	S-VID	End Point ID	SVID2	ENNI2_OVC2_End_Point_1
S-VID	End Point ID								
SVID2	ENNI1_OVC2_End_Point_1								
S-VID	End Point ID								
SVID2	ENNI2_OVC2_End_Point_1								
Test Procedure	Tester transmits single S-tagged test frames at each ENNI, that are mapped to OVC2.								
Expected Results	Single S-tagged test frames are received mapped to OVC2 at ENNI1 and ENNI2: The Destination Address, the Source Address, the Ethertype/Length and S-Tag format is set according to the IEEE standard 802.1ad; the S-Tag TPID is set to 0x88A8.								
Verdict	PASS, FAIL, or INCONCLUSIVE								

6.3 Double-tagged Frames at ENNI, ENNI frames

ABSTRACT TEST CASES FOR ENNI PHASE 1									
Test Case ID	ENNI_ATTRIBUTES.R8.2								
Reference Document Source	MEF 26, R7, R6, R8								
Test Status	Mandatory								
Requirement	R6: Each ENNI Frame MUST have the standard Ethernet format with one of the tag configurations specified in Table 3 of [MEF 26]. [DA = Destination Address, SA = Source Address, ET = Ethertype/Length, S-Tag with Tag Protocol Identification Field (TPID) = 0x88A8, C-Tag with TPID = 0x8100.] R7: An S-Tag MUST have the format specified in Sections 9.5 and 9.7 of [IEEE 802.1ad]. A C-Tag MUST have the format specified in Sections 9.5 and 9.6 of [IEEE 802.1ad]. R8: A C-Tag MUST have the format specified in Sections 9.5 and 9.6 of [IEEE 802.1ad].								
Test Purpose	Verify the double-tagged frame format at ENNI1 by sending double-tagged frames at both ENNI1 and ENNI2.								
Conditions	None								
Test Topology/OVC	<table border="1" style="margin-top: 10px;"> <thead> <tr> <th>S-VID</th> <th>End Point ID</th> </tr> </thead> <tbody> <tr> <td>SVID2</td> <td>ENNI1_OVC2_End_Point_1</td> </tr> </tbody> </table> <table border="1" style="margin-top: 10px;"> <thead> <tr> <th>S-VID</th> <th>End Point ID</th> </tr> </thead> <tbody> <tr> <td>SVID2</td> <td>ENNI2_OVC2_End_Point_1</td> </tr> </tbody> </table>	S-VID	End Point ID	SVID2	ENNI1_OVC2_End_Point_1	S-VID	End Point ID	SVID2	ENNI2_OVC2_End_Point_1
S-VID	End Point ID								
SVID2	ENNI1_OVC2_End_Point_1								
S-VID	End Point ID								
SVID2	ENNI2_OVC2_End_Point_1								
Test Procedure	Tester transmits double-tagged test frames at each ENNI, that are mapped to OVC2. The inner tag (CE-VID) can be chosen arbitrarily at each ENNI, respectively.								
Expected Results	Double-tagged test frames are received at ENNI1 and ENNI2, mapped to OVC2: The Destination Address, the Source Address, the Ethertype/Length and S-Tag format are set according to the IEEE standard 802.1ad; the TPID of the outer tag is 0x88A8, the TPID of the inner tag is 0x8100; the TPID and CE-VID of the inner tag received at ENNI1 or ENNI2, respectively, must match what has been transmitted at the other interface.								
Verdict	PASS, FAIL, or INCONCLUSIVE								

6.4 Single-tagged Frames at ENNI with an Invalid FCS, ENNI frames

ABSTRACT TEST CASES FOR ENNI PHASE 1									
Test Case ID	ENNI_ATTRIBUTES.R9.2								
Reference Document Source	MEF 26, R9								
Test Status	Mandatory								
Requirement	An ingress ENNI Frame that is invalid as defined in Clause 3.4 of [802.3 – 2005] MUST be discarded by the receiving Operator MEN.								
Test Purpose	Verify that if the tester sends single-tagged frames at ENNI with an invalid FCS, the Operator MEN discards them.								
Conditions	Number of ENNI OVC End Points > 1								
Test Topology/OVC	<table border="1" style="display: inline-table; margin-right: 20px;"> <thead> <tr> <th>S-VID</th> <th>End Point ID</th> </tr> </thead> <tbody> <tr> <td>SVID2</td> <td>ENNI1_OVC2_End_Point_1</td> </tr> </tbody> </table> <table border="1" style="display: inline-table;"> <thead> <tr> <th>S-VID</th> <th>End Point ID</th> </tr> </thead> <tbody> <tr> <td>SVID2</td> <td>ENNI2_OVC2_End_Point_1</td> </tr> </tbody> </table>	S-VID	End Point ID	SVID2	ENNI1_OVC2_End_Point_1	S-VID	End Point ID	SVID2	ENNI2_OVC2_End_Point_1
S-VID	End Point ID								
SVID2	ENNI1_OVC2_End_Point_1								
S-VID	End Point ID								
SVID2	ENNI2_OVC2_End_Point_1								
Test Procedure	Tester transmits single S-Tagged test frames at ENNI1, that are mapped to OVC2: the FCS is incorrect. Tester transmits single S-Tagged test frames at ENNI2, that are mapped to OVC2: the FCS is incorrect.								
Expected Results	No test frames received at ENNI1 or at ENNI2.								
Verdict	PASS, FAIL, or INCONCLUSIVE								

6.5 Double-tagged Frames at ENNI with an Invalid FCS, ENNI frames

ABSTRACT TEST CASES FOR ENNI PHASE 1									
Test Case ID	ENNI_ATTRIBUTES.R9.4								
Reference Document Source	MEF 26, R9								
Test Status	Mandatory								
Requirement	An ingress ENNI Frame that is invalid as defined in Clause 3.4 of [802.3 – 2005] MUST be discarded by the receiving Operator MEN.								
Test Purpose	Verify that if the tester sends double-tagged frames at ENNIs with an invalid FCS, the Operator MEN discards them.								
Conditions	Number of ENNI OVC End Points > 1								
Test Topology/OVC	<table border="1" style="margin-top: 10px;"> <thead> <tr> <th>S-VID</th> <th>End Point ID</th> </tr> </thead> <tbody> <tr> <td>SVID2</td> <td>ENNI1_OVC2_End_Point_1</td> </tr> </tbody> </table> <table border="1" style="margin-top: 10px;"> <thead> <tr> <th>S-VID</th> <th>End Point ID</th> </tr> </thead> <tbody> <tr> <td>SVID2</td> <td>ENNI2_OVC2_End_Point_1</td> </tr> </tbody> </table>	S-VID	End Point ID	SVID2	ENNI1_OVC2_End_Point_1	S-VID	End Point ID	SVID2	ENNI2_OVC2_End_Point_1
S-VID	End Point ID								
SVID2	ENNI1_OVC2_End_Point_1								
S-VID	End Point ID								
SVID2	ENNI2_OVC2_End_Point_1								
Test Procedure	Tester transmits double-tagged test frames, that are mapped to OVC2 at ENNI1: the FCS is incorrect. Tester transmits double-tagged test frames, that are mapped to OVC2 at ENNI2: the FCS is incorrect.								
Expected Results	No test frames received at ENNI1 or ENNI2.								
Verdict	PASS, FAIL, or INCONCLUSIVE								

6.6 Discarding of Single-tagged ENNI Frames Below Minimum Size

ABSTRACT TEST CASES FOR ENNI PHASE 1									
Test Case ID	ENNI_ATTRIBUTES.R10.1								
Reference Document Source	MEF 26, R10								
Test Status	Mandatory								
Requirement	An ingress ENNI Frame whose length is less than 64 octets MUST be discarded by the receiving Operator MEN as per Clause 4.2.4.2.2 of [802.3 – 2005]								
Test Purpose	Verify that the Operator MEN discards single-tagged ENNI frames with size below 64 octets.								
Conditions	Number of ENNI OVC End Points > 1								
Test Topology/OVC	<p>The diagram illustrates the test topology. Two Test Systems are connected to ENNI1 and ENNI2 respectively. Both ENNI1 and ENNI2 are connected to OVC2. OVC2 is connected to Operator MEN. Below the diagram are two tables for S-VID and End Point ID.</p> <table border="1" style="display: inline-table; margin-right: 20px;"> <thead> <tr> <th>S-VID</th> <th>End Point ID</th> </tr> </thead> <tbody> <tr> <td>SVID2</td> <td>ENNI1_OVC2_End_Point_1</td> </tr> </tbody> </table> <table border="1" style="display: inline-table;"> <thead> <tr> <th>S-VID</th> <th>End Point ID</th> </tr> </thead> <tbody> <tr> <td>SVID2</td> <td>ENNI2_OVC2_End_Point_1</td> </tr> </tbody> </table>	S-VID	End Point ID	SVID2	ENNI1_OVC2_End_Point_1	S-VID	End Point ID	SVID2	ENNI2_OVC2_End_Point_1
S-VID	End Point ID								
SVID2	ENNI1_OVC2_End_Point_1								
S-VID	End Point ID								
SVID2	ENNI2_OVC2_End_Point_1								
Test Procedure	Tester transmits single S-Tagged test frames at each ENNI, that are mapped to OVC2: Frame size is set to 63 octets.								
Expected Results	No test frames are received at ENNI1 or ENNI2								
Verdict	PASS, FAIL, or INCONCLUSIVE								

6.7 Discarding of Double-tagged ENNI Frames Below Minimum Size

ABSTRACT TEST CASES FOR ENNI PHASE 1									
Test Case ID	ENNI_ATTRIBUTES.R10.2								
Reference Document Source	MEF 26, R10								
Test Status	Mandatory								
Requirement	An ingress ENNI Frame whose length is less than 64 octets MUST be discarded by the receiving Operator MEN as per Clause 4.2.4.2.2 of [802.3 – 2005]								
Test Purpose	Verify that the Operator MEN discards double-tagged ENNI Frames with size below 64 octets.								
Conditions	Number of ENNI OVC End Points > 1								
Test Topology/OVC	<table border="1" style="display: inline-table; margin-right: 20px;"> <thead> <tr> <th>S-VID</th> <th>End Point ID</th> </tr> </thead> <tbody> <tr> <td>SVID2</td> <td>ENNI1_OVC2_End_Point_1</td> </tr> </tbody> </table> <table border="1" style="display: inline-table;"> <thead> <tr> <th>S-VID</th> <th>End Point ID</th> </tr> </thead> <tbody> <tr> <td>SVID2</td> <td>ENNI2_OVC2_End_Point_1</td> </tr> </tbody> </table>	S-VID	End Point ID	SVID2	ENNI1_OVC2_End_Point_1	S-VID	End Point ID	SVID2	ENNI2_OVC2_End_Point_1
S-VID	End Point ID								
SVID2	ENNI1_OVC2_End_Point_1								
S-VID	End Point ID								
SVID2	ENNI2_OVC2_End_Point_1								
Test Procedure	Tester transmits double-tagged test frames at each ENNI, that are mapped to OVC2: Frame size is set to 63 octets.								
Expected Results	No test frames are received at ENNI1 or ENNI2.								
Verdict	PASS, FAIL, or INCONCLUSIVE								



### 6.8 Single-tagged Frame Forwarding at ENNI and at Maximum Frame Size

ABSTRACT TEST CASES FOR ENNI PHASE 1									
Test Case ID	ENNI_ATTRIBUTES.R14.1								
Reference Document Source	MEF 26, R14								
Test Status	Mandatory								
Requirement	The ENNI Maximum Transmission Unit Size MUST be at least 1526 bytes.								
Test Purpose	Verify the single-tagged frame forwarding at ENNI MTU size.								
Conditions	Number of ENNI OVC End Points > 1								
Test Topology/OVC	<table border="1" style="margin-top: 10px;"> <thead> <tr> <th>S-VID</th> <th>End Point ID</th> </tr> </thead> <tbody> <tr> <td>SVID2</td> <td>ENNI1_OVC2_End_Point_1</td> </tr> </tbody> </table> <table border="1" style="margin-top: 10px;"> <thead> <tr> <th>S-VID</th> <th>End Point ID</th> </tr> </thead> <tbody> <tr> <td>SVID2</td> <td>ENNI2_OVC2_End_Point_1</td> </tr> </tbody> </table>	S-VID	End Point ID	SVID2	ENNI1_OVC2_End_Point_1	S-VID	End Point ID	SVID2	ENNI2_OVC2_End_Point_1
S-VID	End Point ID								
SVID2	ENNI1_OVC2_End_Point_1								
S-VID	End Point ID								
SVID2	ENNI2_OVC2_End_Point_1								
Test Procedure	Tester transmits single-tagged test frames at each ENNI, that are mapped to OVC2: Frame size is set to 1526 octets.								
Expected Results	All test frames are received at ENNI1 or ENNI2, are mapped to OVC2.								
Verdict	PASS, FAIL, or INCONCLUSIVE								

6.9 Double-tagged Frame Forwarding at ENNI and at Maximum Frame Size

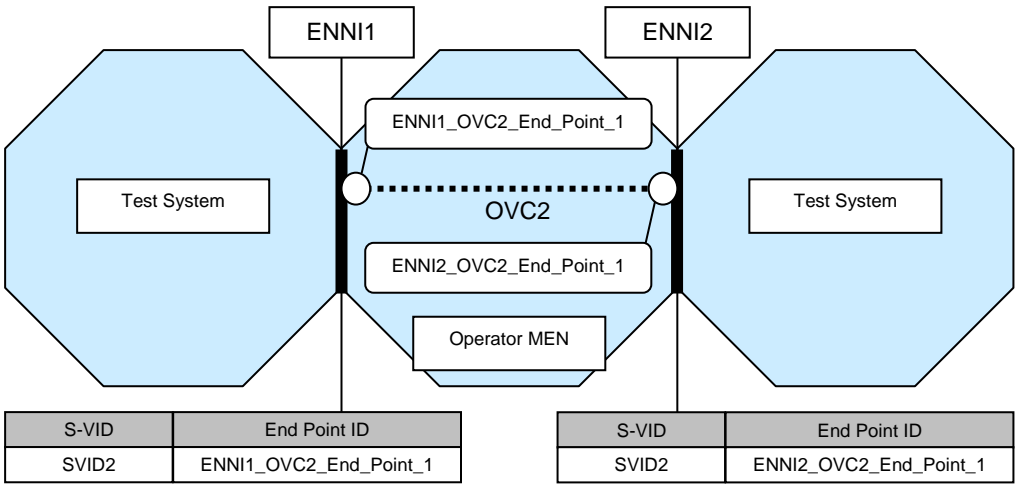
ABSTRACT TEST CASES FOR ENNI PHASE 1									
Test Case ID	ENNI_ATTRIBUTES.R14.2								
Reference Document Source	MEF 26, R14								
Test Status	Mandatory								
Requirement	The ENNI Maximum Transmission Unit Size MUST be at least 1526 bytes.								
Test Purpose	Verify the double-tagged frame forwarding at ENNI MTU size.								
Conditions	none								
Test Topology/OVC	 <p>The diagram illustrates a test topology for double-tagged frame forwarding. Two Test Systems are connected to a central OVC2 (Operator Managed Network) through two ENNI (Ethernet Network-to-Network Interface) points, ENNI1 and ENNI2. ENNI1 and ENNI2 are connected to OVC2 through End Point IDs ENNI1_OVC2_End_Point_1 and ENNI2_OVC2_End_Point_1, respectively. An Operator MEN (Managed Element Network) is also connected to OVC2. Below the diagram are two tables mapping S-VID (SVID2) to End Point IDs (ENNI1_OVC2_End_Point_1 and ENNI2_OVC2_End_Point_1).</p> <table border="1" data-bbox="427 963 890 1041"> <thead> <tr> <th>S-VID</th> <th>End Point ID</th> </tr> </thead> <tbody> <tr> <td>SVID2</td> <td>ENNI1_OVC2_End_Point_1</td> </tr> </tbody> </table> <table border="1" data-bbox="986 963 1449 1041"> <thead> <tr> <th>S-VID</th> <th>End Point ID</th> </tr> </thead> <tbody> <tr> <td>SVID2</td> <td>ENNI2_OVC2_End_Point_1</td> </tr> </tbody> </table>	S-VID	End Point ID	SVID2	ENNI1_OVC2_End_Point_1	S-VID	End Point ID	SVID2	ENNI2_OVC2_End_Point_1
S-VID	End Point ID								
SVID2	ENNI1_OVC2_End_Point_1								
S-VID	End Point ID								
SVID2	ENNI2_OVC2_End_Point_1								
Test Procedure	Tester transmits double-tagged test frames at each ENNI, that are mapped to OVC2: Frame size is set to 1526 octets.								
Expected Results	All test frames are received at ENNI1 and ENNI2, mapped to OVC2.								
Verdict	PASS, FAIL, or INCONCLUSIVE								

6.10 Frames at ENNI Larger than MTU

ABSTRACT TEST CASES FOR ENNI PHASE 1									
Test Case ID	ENNI_ATTRIBUTES.R15.1								
Reference Document Source	MEF 26, R15								
Test Status	Mandatory								
Requirement	When an ENNI Frame is larger than the MTU, the receiving Operator MEN for this frame <b>MUST</b> discard it, and the frame may or may not be ignored in the operation of a Bandwidth Profile that applies to this ENNI Frame.								
Test Purpose	Verify that the Operator MEN discards ENNI Frames that exceed the MTU of the receiving Operator MEN.								
Conditions	none								
Test Topology/OVC	<p>The diagram illustrates the test topology. Two Test Systems are connected to ENNI1 and ENNI2 respectively. These ENNIs are connected to an OVC2. The OVC2 is connected to an Operator MEN. Below the diagram are two tables for S-VID and End Point ID.</p> <table border="1" style="display: inline-table; margin-right: 20px;"> <thead> <tr> <th>S-VID</th> <th>End Point ID</th> </tr> </thead> <tbody> <tr> <td>SVID2</td> <td>ENNI1_OVC2_End_Point_1</td> </tr> </tbody> </table> <table border="1" style="display: inline-table;"> <thead> <tr> <th>S-VID</th> <th>End Point ID</th> </tr> </thead> <tbody> <tr> <td>SVID2</td> <td>ENNI2_OVC2_End_Point_1</td> </tr> </tbody> </table>	S-VID	End Point ID	SVID2	ENNI1_OVC2_End_Point_1	S-VID	End Point ID	SVID2	ENNI2_OVC2_End_Point_1
S-VID	End Point ID								
SVID2	ENNI1_OVC2_End_Point_1								
S-VID	End Point ID								
SVID2	ENNI2_OVC2_End_Point_1								
Test Procedure	Tester transmits test frames at each ENNI, that are mapped to OVC2: Frame size is set to "ENNI_MTU"+1 octets.								
Expected Results	No test frames are received at ENNI1 or ENNI2.								
Verdict	PASS, FAIL, or INCONCLUSIVE								

6.11 OVC Mapping by S-VLAN ID

ABSTRACT TEST CASES FOR ENNI PHASE 1													
Test Case ID	ENNI_ATTRIBUTES.R16.1												
Reference Document Source	MEF 26, R16												
Test Status	Mandatory												
Requirement	For a given S-Tagged ENNI Frame, the End Point to which it is mapped <b>MUST</b> be determined by the S-VLAN ID value in the S-Tag.												
Test Purpose	Verify that the Operator MEN selects an OVC to map the ingress frame to by its S-VLAN ID.												
Conditions	Number of ENNI OVC End Points > 1												
Test Topology/OVC	<table border="1" style="margin-left: auto; margin-right: auto;"> <thead> <tr> <th>S-VID</th> <th>End Point ID</th> </tr> </thead> <tbody> <tr> <td>SVID2</td> <td>ENNI1_OVC2_End_Point_1</td> </tr> <tr> <td>SVID9</td> <td>ENNI1_OVC7_End_Point_1</td> </tr> </tbody> </table> <table border="1" style="margin-left: auto; margin-right: auto;"> <thead> <tr> <th>S-VID</th> <th>End Point ID</th> </tr> </thead> <tbody> <tr> <td>SVID3</td> <td>ENNI2_OVC2_End_Point_1</td> </tr> <tr> <td>SVID10</td> <td>ENNI2_OVC7_End_Point_1</td> </tr> </tbody> </table>	S-VID	End Point ID	SVID2	ENNI1_OVC2_End_Point_1	SVID9	ENNI1_OVC7_End_Point_1	S-VID	End Point ID	SVID3	ENNI2_OVC2_End_Point_1	SVID10	ENNI2_OVC7_End_Point_1
S-VID	End Point ID												
SVID2	ENNI1_OVC2_End_Point_1												
SVID9	ENNI1_OVC7_End_Point_1												
S-VID	End Point ID												
SVID3	ENNI2_OVC2_End_Point_1												
SVID10	ENNI2_OVC7_End_Point_1												
Test Procedure	<p>Tester transmits single S-Tagged test frames A at each ENNI, that are mapped to OVC2: the S-VLAN ID is mapped to OVC2</p> <p>Tester transmits single S-Tagged test frames B at each ENNI: the S-VLAN ID is not mapped to any OVC</p> <p>Tester transmits single S-Tagged test frames C at each ENNI, that are mapped to OVC7: the S-VLAN IDs is mapped to OVC7</p> <p>Tester transmits single S-Tagged test frames D at each ENNI: the S-VLAN IDs is not mapped to any OVC</p>												
Expected Results	<p>All test frames A are received at ENNI1 and ENNI2, mapped to OVC2.</p> <p>No test frames B are received at any External Interfaces .</p> <p>All test frames C are received at ENNI1 and ENNI2, mapped to OVC7.</p> <p>No test frames D are received at ENNI1 or ENNI2.</p>												
Verdict	PASS, FAIL, or INCONCLUSIVE												

### 6.12 Not mapped S-Tagged ENNI Frames

ABSTRACT TEST CASES FOR ENNI PHASE 1													
Test Case ID	ENNI_ATTRIBUTES.R19.1												
Reference Document Source	MEF 26, R19												
Test Status	Mandatory												
Requirement	An ingress S-Tagged ENNI Frame that is not mapped to an existing End Point <b>MUST NOT</b> be forwarded to an External Interface by the receiving Operator MEN.												
Test Purpose	Verify that ingress S-Tagged ENNI Frames containing an S-VLAN ID not mapped to any OVC are not forwarded by the receiving Operator MEN.												
Conditions	none												
Test Topology/OVC	<table border="1" style="margin-left: auto; margin-right: auto;"> <thead> <tr> <th>S-VID</th> <th>End Point ID</th> </tr> </thead> <tbody> <tr> <td>SVID2</td> <td>ENNI1_OVC2_End_Point_1</td> </tr> <tr> <td>SVID40</td> <td>none</td> </tr> </tbody> </table> <table border="1" style="margin-left: auto; margin-right: auto;"> <thead> <tr> <th>S-VID</th> <th>End Point ID</th> </tr> </thead> <tbody> <tr> <td>SVID2</td> <td>ENNI2_OVC2_End_Point_1</td> </tr> <tr> <td>SVID40</td> <td>none</td> </tr> </tbody> </table>	S-VID	End Point ID	SVID2	ENNI1_OVC2_End_Point_1	SVID40	none	S-VID	End Point ID	SVID2	ENNI2_OVC2_End_Point_1	SVID40	none
S-VID	End Point ID												
SVID2	ENNI1_OVC2_End_Point_1												
SVID40	none												
S-VID	End Point ID												
SVID2	ENNI2_OVC2_End_Point_1												
SVID40	none												
Test Procedure	Tester transmits test frames tagged with SVID40 at each ENNI: S-VLAN ID SVID40 is not mapped to any OVC at ENNI1 or ENNI2.												
Expected Results	None of the unmapped test frames are received at at ENNI1 or ENNI2.												
Verdict	PASS, FAIL, or INCONCLUSIVE												

6.13 Not mapped Untagged ENNI Frames

ABSTRACT TEST CASES FOR ENNI PHASE 1									
Test Case ID	ENNI_ATTRIBUTES.R20.1								
Reference Document Source	MEF 26, R20								
Test Status	Mandatory								
Requirement	An untagged ENNI Frame <b>MUST NOT</b> be mapped to an OVC End Point.								
Test Purpose	Verify that untagged ingress ENNI Frames are not forwarded by the receiving Operator MEN.								
Conditions	none								
Test Topology/OVC	<p>The diagram illustrates the test topology. Two Test Systems are connected to an OVC2 through ENNI1 and ENNI2. The OVC2 contains two end points: ENNI1_OVC2_End_Point_1 and ENNI2_OVC2_End_Point_1. These end points are connected to an Operator MEN. Below the diagram, two tables provide the S-VID and End Point ID for each ENNI connection.</p> <table border="1"> <thead> <tr> <th>S-VID</th> <th>End Point ID</th> </tr> </thead> <tbody> <tr> <td>SVID2</td> <td>ENNI1_OVC2_End_Point_1</td> </tr> </tbody> </table> <table border="1"> <thead> <tr> <th>S-VID</th> <th>End Point ID</th> </tr> </thead> <tbody> <tr> <td>SVID2</td> <td>ENNI2_OVC2_End_Point_1</td> </tr> </tbody> </table>	S-VID	End Point ID	SVID2	ENNI1_OVC2_End_Point_1	S-VID	End Point ID	SVID2	ENNI2_OVC2_End_Point_1
S-VID	End Point ID								
SVID2	ENNI1_OVC2_End_Point_1								
S-VID	End Point ID								
SVID2	ENNI2_OVC2_End_Point_1								
Test Procedure	Tester transmits untagged test frames at each ENNI.								
Expected Results	No test frames are received at ENNI1 or ENNI2.								
Verdict	PASS, FAIL, or INCONCLUSIVE								

### 6.14 Frame Delivery without Looping

ABSTRACT TEST CASES FOR ENNI PHASE 1									
Test Case ID	ENNI_ATTRIBUTES.R28.1								
Reference Document Source	MEF 26, R28								
Test Status	Mandatory								
Requirement	If an egress frame mapped to an OVC End Point results from an ingress frame mapped to an OVC End Point, there <b>MUST</b> be an OVC that associates the two OVC End Points. And, the two OVC End Points <b>MUST</b> be different from each other.								
Test Purpose	Verify that no ENNI frame sent through an ingress OVC endpoint is delivered to the same OVC endpoint.								
Conditions	none								
Test Topology/OVC	<p>The diagram illustrates the test topology for OVC2. It shows two ENNI nodes, ENNI1 and ENNI2, connected to a central OVC2. ENNI1 is connected to ENNI1_OVC2_End_Point_1, and ENNI2 is connected to ENNI2_OVC2_End_Point_1. Both end points are connected to OVC2. An Operator MEN is also connected to OVC2. Two Test Systems are connected to ENNI1 and ENNI2 respectively. Below the diagram is a table with two columns: S-VID and End Point ID. The first row shows SVID2 and ENNI1_OVC2_End_Point_1. The second row shows SVID2 and ENNI2_OVC2_End_Point_1.</p> <table border="1"> <thead> <tr> <th>S-VID</th> <th>End Point ID</th> </tr> </thead> <tbody> <tr> <td>SVID2</td> <td>ENNI1_OVC2_End_Point_1</td> </tr> </tbody> </table> <table border="1"> <thead> <tr> <th>S-VID</th> <th>End Point ID</th> </tr> </thead> <tbody> <tr> <td>SVID2</td> <td>ENNI2_OVC2_End_Point_1</td> </tr> </tbody> </table>	S-VID	End Point ID	SVID2	ENNI1_OVC2_End_Point_1	S-VID	End Point ID	SVID2	ENNI2_OVC2_End_Point_1
S-VID	End Point ID								
SVID2	ENNI1_OVC2_End_Point_1								
S-VID	End Point ID								
SVID2	ENNI2_OVC2_End_Point_1								
Test Procedure	Tester transmits unicast, broadcast, multicast, and unknown test frames at ENNI2, that are mapped to OVC2.								
Expected Results	All test frames are received at ENNI1, mapped to OVC2. No test frames are received at ENNI2								
Verdict	PASS, FAIL, or INCONCLUSIVE								

6.15 Forwarding of Untagged Service Frames of OVC MTUSize

ABSTRACT TEST CASES FOR ENNI PHASE 1									
Test Case ID	OVC_ATTRIBUTES.R32.1								
Reference Document Source	MEF 26, R32								
Test Status	Mandatory								
Requirement	The OVC Maximum Transmission Unit Size <b>MUST</b> be at least 1526 bytes.								
Test Purpose	Verify that the OVC is able to forward single-tagged ENNI frames with at least the size of 1526 octets.								
Conditions	none								
Test Topology/OVC	<table border="1" style="margin-top: 10px;"> <thead> <tr> <th>S-VID</th> <th>End Point ID</th> </tr> </thead> <tbody> <tr> <td>SVID2</td> <td>ENNI1_OVC2_End_Point_1</td> </tr> </tbody> </table> <table border="1" style="margin-top: 10px;"> <thead> <tr> <th>S-VID</th> <th>End Point ID</th> </tr> </thead> <tbody> <tr> <td>SVID2</td> <td>ENNI2_OVC2_End_Point_1</td> </tr> </tbody> </table>	S-VID	End Point ID	SVID2	ENNI1_OVC2_End_Point_1	S-VID	End Point ID	SVID2	ENNI2_OVC2_End_Point_1
S-VID	End Point ID								
SVID2	ENNI1_OVC2_End_Point_1								
S-VID	End Point ID								
SVID2	ENNI2_OVC2_End_Point_1								
Test Procedure	Tester transmits single S-Tagged test frames at each ENNI, that are mapped to OVC2: Frame size is set to 1526 octets.								
Expected Results	All test frames transmitted at ENNI1 are received at ENNI2, mapped to OVC2. All test frames transmitted at ENNI2 are received at ENNI1, mapped to OVC2.								
Verdict	PASS, FAIL, or INCONCLUSIVE								



### 6.16 Forwarding of Double-Tagged ENNI Frames of OVC MTU Size

ABSTRACT TEST CASES FOR ENNI PHASE 1									
Test Case ID	OVC_ATTRIBUTES.R32.2								
Reference Document Source	MEF 26, R32								
Test Status	Mandatory								
Requirement	The OVC Maximum Transmission Unit Size <b>MUST</b> be at least 1526 bytes.								
Test Purpose	Verify that the OVC is able to forward double-tagged ENNI frames with at least a size of 1526 octets.								
Conditions	none								
Test Topology/OVC	<p>The diagram illustrates the test topology. Two Test Systems are connected to an OVC2 through ENNI1 and ENNI2. The OVC2 has two End Point IDs: ENNI1_OVC2_End_Point_1 and ENNI2_OVC2_End_Point_1. An Operator MEN is also shown. Below the diagram are two tables for S-VID and End Point ID mappings.</p> <table border="1"> <thead> <tr> <th>S-VID</th> <th>End Point ID</th> </tr> </thead> <tbody> <tr> <td>SVID2</td> <td>ENNI1_OVC2_End_Point_1</td> </tr> </tbody> </table> <table border="1"> <thead> <tr> <th>S-VID</th> <th>End Point ID</th> </tr> </thead> <tbody> <tr> <td>SVID2</td> <td>ENNI2_OVC2_End_Point_1</td> </tr> </tbody> </table>	S-VID	End Point ID	SVID2	ENNI1_OVC2_End_Point_1	S-VID	End Point ID	SVID2	ENNI2_OVC2_End_Point_1
S-VID	End Point ID								
SVID2	ENNI1_OVC2_End_Point_1								
S-VID	End Point ID								
SVID2	ENNI2_OVC2_End_Point_1								
Test Procedure	Tester transmits double-tagged test frames at each ENNI, that are mapped to OVC2: Frame size is set to 1526 octets								
Expected Results	All test frames transmitted at ENNI1 are received at ENNI2, mapped to OVC2. All test frames transmitted at ENNI2 are received at ENNI1, mapped to OVC2.								
Verdict	PASS, FAIL, or INCONCLUSIVE								

6.17 ENNI Frames Larger Than The OVC MTU Size

ABSTRACT TEST CASES FOR ENNI PHASE 1									
Test Case ID	OVC_ATTRIBUTES.R33.1								
Reference Document Source	MEF 26, R33								
Test Status	Mandatory								
Requirement	When an ENNI Frame or a Service Frame is larger than the OVC MTU Size for the OVC associating the OVC End Point to which it is mapped, the receiving Operator for this frame MUST discard it, and the operation of a Bandwidth Profile that applies to this frame is not defined.								
Test Purpose	Verify that the ENNI frames are discarded, if they are larger than the MTU size of the OVC to which the frames are mapped.								
Conditions	none								
Test Topology/OVC	<table border="1" style="margin-top: 10px;"> <thead> <tr> <th>S-VID</th> <th>End Point ID</th> </tr> </thead> <tbody> <tr> <td>SVID2</td> <td>ENNI1_OVC2_End_Point_1</td> </tr> </tbody> </table> <table border="1" style="margin-top: 10px;"> <thead> <tr> <th>S-VID</th> <th>End Point ID</th> </tr> </thead> <tbody> <tr> <td>SVID2</td> <td>ENNI2_OVC2_End_Point_1</td> </tr> </tbody> </table>	S-VID	End Point ID	SVID2	ENNI1_OVC2_End_Point_1	S-VID	End Point ID	SVID2	ENNI2_OVC2_End_Point_1
S-VID	End Point ID								
SVID2	ENNI1_OVC2_End_Point_1								
S-VID	End Point ID								
SVID2	ENNI2_OVC2_End_Point_1								
Test Procedure	Tester transmits test frames at each ENNI, that are mapped to OVC2: Frame size is set to OVC_MTU+1 octets.								
Expected Results	None of the test frames may be received at any External Interface								
Verdict	PASS, FAIL, or INCONCLUSIVE								

6.18 S-VLAN ID Preservation Set to "No"

ABSTRACT TEST CASES FOR ENNI PHASE 1									
Test Case ID	OVC_ATTRIBUTES.R41.1								
Reference Document Source	MEF 26, R41								
Test Status	Mandatory								
Requirement	When an OVC has the S-VLAN ID Preservation attribute with a value of No, an egress ENNI Frame mapped to an OVC End Point resulting from an ingress ENNI Frame mapped to a different OVC End Point MUST have an S-VLAN ID value that has a one-to-one association with the S-VLAN ID of the ingress service frame.								
Test Purpose	Verify that if S-VLAN ID preservation is set to "No" for a particular OVC associated with two ENNIs, the ENNI frames can be forwarded between the two OVC end points and the S-VLAN IDs of the ingress and egress frames have a one-to-one association.								
Conditions	S-VLAN ID Preservation = "No"								
Test Topology/OVC	<table border="1" style="margin-top: 10px;"> <thead> <tr> <th>S-VID</th> <th>End Point ID</th> </tr> </thead> <tbody> <tr> <td>SVID9</td> <td>ENNI1_OVC7_End_Point_1</td> </tr> </tbody> </table> <table border="1" style="margin-top: 10px;"> <thead> <tr> <th>S-VID</th> <th>End Point ID</th> </tr> </thead> <tbody> <tr> <td>SVID10</td> <td>ENNI2_OVC7_End_Point_1</td> </tr> </tbody> </table>	S-VID	End Point ID	SVID9	ENNI1_OVC7_End_Point_1	S-VID	End Point ID	SVID10	ENNI2_OVC7_End_Point_1
S-VID	End Point ID								
SVID9	ENNI1_OVC7_End_Point_1								
S-VID	End Point ID								
SVID10	ENNI2_OVC7_End_Point_1								
Test Procedure	Tester transmits double-tagged and single S-Tagged test frames mapped to OVC7 at ENNI1. Tester transmits double-tagged and single S-Tagged test frames mapped to OVC7 at ENNI2.								
Expected Results	All test frames transmitted from ENNI1 are received at ENNI2, mapped to OVC7. All test frames transmitted from ENNI2 are received at ENNI1, mapped to OVC7.								
Verdict	PASS, FAIL, or INCONCLUSIVE								

6.19 Unconditional Unicast frame Delivery

ABSTRACT TEST CASES FOR ENNI PHASE 1	
Test Case ID	OVC_ATTRIBUTES.R44.1
Reference Document Source	MEF 26, R44
Test Status	Conditional Mandatory
Requirement	When the Unicast Frame Delivery is "unconditional," all properly formatted ingress frames mapped to an OVC End Point at an External Interface with a unicast destination MAC address MUST be delivered to all of the other OVC End Points in the OVC.
Test Purpose	Verify that all unicast ENNI Frames sent at ENNI1, ENNI2, and ENNI4 which are mapped to an OVC are forwarded to ENNI1, ENNI2 and ENNI4, if Unconditional Unicast Frame Delivery is enabled for the OVC over which the frames were forwarded.
Conditions	Unconditional Unicast Frame Delivery = "Yes", Number of ENNI OVC End Points > 2
Test Topology/OVC	<p>The diagram illustrates the test topology for OVC8. It features three Test Systems, each represented by a blue octagon. The top-left Test System is connected to ENNI1, which is associated with SVID11 and End Point ID ENNI1_OVC8_End_Point_1. The top-right Test System is connected to ENNI2, associated with SVID12 and End Point ID ENNI2_OVC8_End_Point_1. The bottom Test System is connected to ENNI4, associated with SVID12 and End Point ID ENNI4_OVC8_End_Point_1. All three ENNIs are connected to a central OVC8, represented by a dashed line. An Operator MEN is connected to ENNI1 and ENNI2. The entire setup is labeled 'Test Topology/OVC'.</p>
Test Procedure	Tester transmits test frames that are mapped to OVC8 at ENNI1.; "Flow Definition" is set to "[Unicast frames of "Frame Sizes"]" Tester transmits test frames that are mapped to OVC8 at ENNI2: "Flow Definition" is set to "[Unicast frames of "Frame Sizes"]" Tester transmits test frames that are mapped to OVC8 at ENNI4: "Flow Definition" is set to "[Unicast frames of "Frame Sizes"]".
Expected Results	All test frames transmitted at the ENNI1 are received at ENNI2 and ENNI4, mapped to OVC8. All test frames transmitted at ENNI2 are received at ENNI1 and ENNI4, mapped to OVC8. All test frames transmitted at ENNI4 are received at ENNI1 and ENNI2, mapped to OVC8.
Verdict	PASS, FAIL, or INCONCLUSIVE

6.20 Unconditional Multicast Frame Delivery

ABSTRACT TEST CASES FOR ENNI PHASE 1	
Test Case ID	OVC_ATTRIBUTES.R46.1
Reference Document Source	MEF 26, R46
Test Status	Conditional Mandatory
Requirement	When the Multicast Frame Delivery is "unconditional," all properly formatted ingress frames mapped to an OVC End Point at an External Interface with a multicast destination MAC address MUST be delivered to all of the other End Points associated by the OVC.
Test Purpose	Verify that all multicast ENNI Frames sent at ENNI1, ENNI2 or ENNI4 are forwarded to ENNI2 and ENNI4, or ENNI1 and ENNI4, or ENNI1 or ENNI2, if unconditional multicast frame delivery is enabled for the OVC over which the multicast ENNI Frames were forwarded.
Conditions	Unconditional Multicast Frame Delivery = "Yes", Number of ENNI OVC End Points > 2
Test Topology/OVC	<p>The diagram illustrates a network topology for testing unconditional multicast frame delivery. It features three Test Systems (represented by octagons) connected to three ENNI (External Network Interface) points: ENNI1, ENNI2, and ENNI4. ENNI1 and ENNI2 are connected to an Operator MEN (Metro Ethernet Network). ENNI1, ENNI2, and ENNI4 are connected to an OVC8 (Operator Virtual Circuit). The OVC8 is represented by a dashed line connecting the three ENNI points. Three tables provide S-VID and End Point ID mappings for each ENNI:</p> <ul style="list-style-type: none"> <li>ENNI1: SVID11, ENNI1_OVC8_End_Point_1</li> <li>ENNI2: SVID12, ENNI2_OVC8_End_Point_1</li> <li>ENNI4: SVID12, ENNI4_OVC8_End_Point_1</li> </ul>
Test Procedure	Tester transmits test frames mapped to OVC8 at ENNI1: "Flow Definition" is set to "[Multicast frames of "Frame Sizes"]" Tester transmits test frames mapped to OVC8 at ENNI2: "Flow Definition" is set to "[Multicast frames of "Frame Sizes"]" Tester transmits test frames mapped to OVC8 at ENNI4: "Flow Definition" is set to "[Multicast frames of "Frame Sizes"]"
Expected Results	All test frames transmitted at the ENNI1 are received at both ENNI2 and ENNI4, mapped to OVC8. All test frames transmitted at the ENNI2 are received at both ENNI1 and ENNI4, mapped to OVC8. All test frames transmitted at the ENNI4 are received at both ENNI1 and ENNI2, mapped to OVC8.

Verdict	PASS, FAIL, or INCONCLUSIVE
---------	-----------------------------

6.21 Unconditional Broadcast Frame Delivery

ABSTRACT TEST CASES FOR ENNI PHASE 1													
Test Case ID	OVC_ATTRIBUTES.R48.1												
Reference Document Source	MEF 26, R48												
Test Status	Conditional Mandatory												
Requirement	When the Broadcast Frame Delivery is "unconditional," all properly formatted ingress frames mapped to an OVC End Point at an External Interface with the broadcast destination MAC address MUST be delivered to all of the other OVC End Points associated by the OVC.												
Test Purpose	Verify that all broadcast ENNI Frames sent at ENNI1, ENNI2 and ENNI4 are forwarded to ENNI2 and ENNI4, or ENNI1 and ENNI4, or ENNI1 and ENNI4, if unconditional broadcast frame delivery is enabled for the OVC over which the test frames were forwarded.												
Conditions	Unconditional Broadcast Frame Delivery = "Yes", Number of ENNI OVC End Points > 2												
Test Topology/OVC	<p>The diagram illustrates a network topology where three Test Systems are connected to a central OVC8. Each Test System is connected to an ENNI (ENNI1, ENNI2, and ENNI4). Each ENNI is connected to an OVC8 End Point. The OVC8 is represented by a dashed line connecting the three End Points. Tables above and below the diagram provide S-VID and End Point ID for each ENNI.</p> <table border="1" style="display: inline-table; margin-right: 20px;"> <thead> <tr> <th>S-VID</th> <th>End Point ID</th> </tr> </thead> <tbody> <tr> <td>SVID11</td> <td>ENNI1_OVC8_End_Point_1</td> </tr> </tbody> </table> <table border="1" style="display: inline-table; margin-right: 20px;"> <thead> <tr> <th>S-VID</th> <th>End Point ID</th> </tr> </thead> <tbody> <tr> <td>SVID12</td> <td>ENNI2_OVC8_End_Point_1</td> </tr> </tbody> </table> <table border="1" style="display: inline-table; margin-left: 20px;"> <thead> <tr> <th>S-VID</th> <th>End Point ID</th> </tr> </thead> <tbody> <tr> <td>SVID12</td> <td>ENNI4_OVC8_End_Point_1</td> </tr> </tbody> </table>	S-VID	End Point ID	SVID11	ENNI1_OVC8_End_Point_1	S-VID	End Point ID	SVID12	ENNI2_OVC8_End_Point_1	S-VID	End Point ID	SVID12	ENNI4_OVC8_End_Point_1
S-VID	End Point ID												
SVID11	ENNI1_OVC8_End_Point_1												
S-VID	End Point ID												
SVID12	ENNI2_OVC8_End_Point_1												
S-VID	End Point ID												
SVID12	ENNI4_OVC8_End_Point_1												
Test Procedure	Tester transmits test frames that are mapped to OVC8 at ENNI1: "Flow Definition" is set to "[Broadcast frames of "Frame Sizes"]" Tester transmits test frames that are mapped to OVC8 at ENNI2: "Flow Definition" is set to "[Broadcast frames of "Frame Sizes"]" Tester transmits test frames that are mapped to OVC8 at ENNI4: "Flow Definition" is set to "[Broadcast frames of "Frame Sizes"]"												
Expected Results	All test frames transmitted at the ENNI1 are received at both ENNI2 and ENNI4, mapped to OVC8. All test frames transmitted at the ENNI2 are received at both ENNI1 and ENNI4, mapped to OVC8. All test frames transmitted at the ENNI4 are received at both ENNI1 and ENNI2, mapped to OVC8.												
Verdict	PASS, FAIL, or INCONCLUSIVE												

## 6.22 OVC End Point Selection at the UNI by the CE-VLAN ID of Tagged Service Frames

ABSTRACT TEST CASES FOR ENNI PHASE 1													
Test Case ID	OVC_per_UNI_ATTRIBUTES.R66.1												
Reference Document Source	MEF 26, R66												
Test Status	Mandatory												
Requirement	The OVC End Point at the UNI for a Service Frame <b>MUST</b> be identified by the value of CE-VLAN ID of the Service Frame.												
Test Purpose	Verify that the correct OVC End Point for Service Frames on a UNI is identified by the CE-VLAN ID of this frame.												
Conditions	None												
Test Topology/OVC	<div style="display: flex; justify-content: space-around; margin-top: 10px;"> <table border="1" style="border-collapse: collapse;"> <thead> <tr> <th>S-VID</th> <th>End Point ID</th> </tr> </thead> <tbody> <tr> <td>SVID15</td> <td>ENNI1_OVC11_End_Point_1</td> </tr> <tr> <td>SVID16</td> <td>ENNI1_OVC12_End_Point_1</td> </tr> </tbody> </table> <table border="1" style="border-collapse: collapse;"> <thead> <tr> <th>CE-VID</th> <th>End Point ID</th> </tr> </thead> <tbody> <tr> <td>CVID7</td> <td>UNI1_OVC11_End_Point</td> </tr> <tr> <td>CVID8</td> <td>UNI1_OVC12_End_Point</td> </tr> </tbody> </table> </div>	S-VID	End Point ID	SVID15	ENNI1_OVC11_End_Point_1	SVID16	ENNI1_OVC12_End_Point_1	CE-VID	End Point ID	CVID7	UNI1_OVC11_End_Point	CVID8	UNI1_OVC12_End_Point
S-VID	End Point ID												
SVID15	ENNI1_OVC11_End_Point_1												
SVID16	ENNI1_OVC12_End_Point_1												
CE-VID	End Point ID												
CVID7	UNI1_OVC11_End_Point												
CVID8	UNI1_OVC12_End_Point												
Test Procedure	<ol style="list-style-type: none"> <li>Tester transmits C-tagged test frames mapped to OVC11 at UNI1.</li> <li>Tester transmits double-tagged test frames mapped to OVC11 at ENNI1.</li> <li>Tester transmits C-tagged test frames mapped to OVC12 at UNI1.</li> <li>Tester transmits double-tagged test frames mapped to OVC12 at ENNI1.</li> </ol>												
Expected Results	<ol style="list-style-type: none"> <li>All test frames are received at ENNI1, mapped to OVC11</li> <li>All test frames are received at UNI1, mapped to OVC11.</li> <li>All test frames are received at ENNI1, mapped to OVC12</li> <li>All test frames are received at UNI1, mapped to OVC12.</li> </ol>												
Verdict	PASS, FAIL, or INCONCLUSIVE												



**6.23 Discarding of Tagged Service Frames at the UNI with CE-VLAN ID not Mapped to any OVC End Point**

ABSTRACT TEST CASES FOR ENNI PHASE 1	
Test Case ID	OVC_per_UNI_ATTRIBUTES.R67.1
Reference Document Source	MEF 26, R67
Test Status	Mandatory
Requirement	An ingress Service Frame that is not mapped to an existing OVC End Point or EVC at the UNI <b>MUST</b> be discarded.
Test Purpose	Verify that the Operator MEN discards Service Frames at the UNI, if the CE-VLAN ID is not mapped to any OVC endpoints on that interface.
Conditions	None
Test Topology/OVC	
Test Procedure	<ol style="list-style-type: none"> <li>1. Tester transmits C-tagged test frames with CVID1 mapped to OVC1 at UNI1.</li> <li>2. Tester transmits C-tagged test frames with CVID2 at UNI1: the CE-VLAN ID is not mapped to any OVC at UNI1.</li> <li>3. Tester transmits untagged test frames at UNI1: the CE-VLAN ID is not mapped to any OVC at UNI1.</li> <li>4. Tester transmits Priority tagged test frames at UNI1: the CE-VLAN ID is not mapped to any OVC at UNI1.</li> </ol>
Expected Results	<ol style="list-style-type: none"> <li>1. All test frames are received at ENNI1, mapped to OVC1.</li> <li>2.-4. No test frames are received at ENNI1.</li> </ol>
Verdict	PASS, FAIL, or INCONCLUSIVE

### 6.24 Single-tagged Frame Forwarding at ENNI Without CE-VLAN ID Preservation

#### Preservation

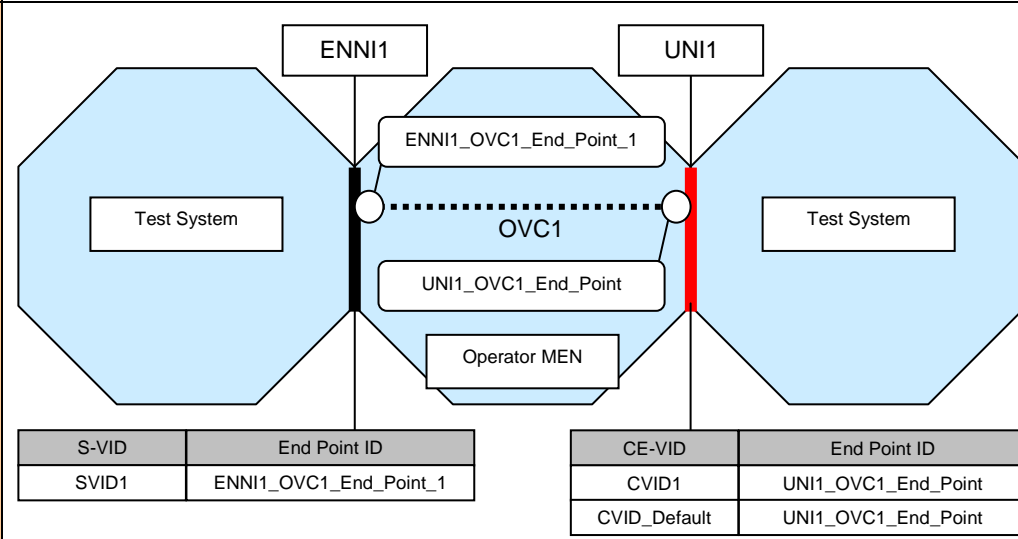
ABSTRACT TEST CASES FOR ENNI PHASE 1											
Test Case ID	OVC_per_UNI_ATTRIBUTES.R69.1										
Reference Document Source	MEF 26, R69										
Test Status	Mandatory										
Requirement	When an OVC associating the OVC End Point to which the CE-VLAN ID for untagged and priority tagged Service Frames is mapped does not have the CE-VLAN ID Preservation attribute in force, egress Service Frames for this OVC End Point at the given UNI <b>MUST</b> be untagged.										
Test Purpose	Verify that egress Services Frames for an OVC End Point are untagged, if the ingress Service Frame were single S-Tagged frames at ENNI, the UNI OVC End Point has a mapping for untagged and priority tagged Service Frames, and the OVC CE-VLAN ID Preservation attribute is not in force.										
Conditions	CE-VLAN ID Preservation = "No"										
Test Topology/OVC	 <table border="1" data-bbox="414 1209 893 1288"> <thead> <tr> <th>S-VID</th> <th>End Point ID</th> </tr> </thead> <tbody> <tr> <td>SVID1</td> <td>ENNI1_OVC1_End_Point_1</td> </tr> </tbody> </table> <table border="1" data-bbox="973 1209 1436 1321"> <thead> <tr> <th>CE-VID</th> <th>End Point ID</th> </tr> </thead> <tbody> <tr> <td>CVID1</td> <td>UNI1_OVC1_End_Point</td> </tr> <tr> <td>CVID_Default</td> <td>UNI1_OVC1_End_Point</td> </tr> </tbody> </table>	S-VID	End Point ID	SVID1	ENNI1_OVC1_End_Point_1	CE-VID	End Point ID	CVID1	UNI1_OVC1_End_Point	CVID_Default	UNI1_OVC1_End_Point
S-VID	End Point ID										
SVID1	ENNI1_OVC1_End_Point_1										
CE-VID	End Point ID										
CVID1	UNI1_OVC1_End_Point										
CVID_Default	UNI1_OVC1_End_Point										
Test Procedure	Tester transmits single S-Tagged test frames mapped to OVC1 at ENNI1.										
Expected Results	All test frames are received at UNI1: frames are untagged.										
Verdict	PASS, FAIL, or INCONCLUSIVE										

6.25 Priority C-tagged Frame Forwarding at ENNI Without CE-VLAN ID

Preservation

ABSTRACT TEST CASES FOR ENNI PHASE 1											
Test Case ID	OVC_per_UNI_ATTRIBUTES.R69.2										
Reference Document Source	MEF 26, R69										
Test Status	Conditional Mandatory										
Requirement	When an OVC associating the OVC End Point to which the CE-VLAN ID for untagged and priority tagged ENNI Frames is mapped does not have the CE-VLAN ID Preservation attribute in force, egress Service Frames for this OVC End Point at the given UNI <b>MUST</b> be untagged.										
Test Purpose	Verify that egress Services Frames for an OVC End Point are untagged, if the ingress ENNI Frames were double-tagged frames at ENNI, the C-Tag of the ingress ENNI Frames was priority tag, the OVC UNI End Point has a mapping for untagged and priority tagged Service Frames, and the OVC CE-VLAN ID Preservation attribute is not in force.										
Conditions	CE-VLAN ID Preservation = "No"										
Test Topology/OVC	<table border="1" style="margin-left: auto; margin-right: auto;"> <thead> <tr> <th>S-VID</th> <th>End Point ID</th> </tr> </thead> <tbody> <tr> <td>SVID1</td> <td>ENNI1_OVC1_End_Point_1</td> </tr> </tbody> </table> <table border="1" style="margin-left: auto; margin-right: auto;"> <thead> <tr> <th>CE-VID</th> <th>End Point ID</th> </tr> </thead> <tbody> <tr> <td>CVID1</td> <td>UNI1_OVC1_End_Point</td> </tr> <tr> <td>CVID_Default</td> <td>UNI1_OVC1_End_Point</td> </tr> </tbody> </table>	S-VID	End Point ID	SVID1	ENNI1_OVC1_End_Point_1	CE-VID	End Point ID	CVID1	UNI1_OVC1_End_Point	CVID_Default	UNI1_OVC1_End_Point
S-VID	End Point ID										
SVID1	ENNI1_OVC1_End_Point_1										
CE-VID	End Point ID										
CVID1	UNI1_OVC1_End_Point										
CVID_Default	UNI1_OVC1_End_Point										
Test Procedure	Tester transmits double-tagged test frames mapped to OVC1 at ENNI1: the CE-VLAN ID is set to 0 (priority C-tag).										
Expected Results	All test frames are received at UNI1: frames are untagged.										
Verdict	PASS, FAIL, or INCONCLUSIVE										

6.26 C-tagged Frame Forwarding at ENNI Without CE-VLAN ID Preservation

ABSTRACT TEST CASES FOR ENNI PHASE 1											
Test Case ID	OVC_per_UNI_ATTRIBUTES.R69.3										
Reference Document Source	MEF 26, R69										
Test Status	Conditional Mandatory										
Requirement	When an OVC associating the OVC End Point to which the CE-VLAN ID for untagged and Priority tagged Service Frames is mapped does not have the CE-VLAN ID Preservation attribute in force, egress Service Frames for this OVC End Point at the given UNI <b>MUST</b> be untagged.										
Test Purpose	Verify that egress Services Frames for an OVC End Point are untagged, if the ingress ENNI Frames were double-tagged frames at ENNI, the OVC UNI End Point has a mapping for untagged Service Frames, and the OVC CE-VLAN ID Preservation attribute is not in force.										
Conditions	CE-VLAN ID Preservation = "No"										
Test Topology/OVC	<table border="1" style="margin-left: auto; margin-right: auto;"> <thead> <tr> <th>S-VID</th> <th>End Point ID</th> </tr> </thead> <tbody> <tr> <td>SVID1</td> <td>ENNI1_OVC1_End_Point_1</td> </tr> </tbody> </table> <table border="1" style="margin-left: auto; margin-right: auto;"> <thead> <tr> <th>CE-VID</th> <th>End Point ID</th> </tr> </thead> <tbody> <tr> <td>CVID1</td> <td>UNI1_OVC1_End_Point</td> </tr> <tr> <td>CVID_Default</td> <td>UNI1_OVC1_End_Point</td> </tr> </tbody> </table>	S-VID	End Point ID	SVID1	ENNI1_OVC1_End_Point_1	CE-VID	End Point ID	CVID1	UNI1_OVC1_End_Point	CVID_Default	UNI1_OVC1_End_Point
S-VID	End Point ID										
SVID1	ENNI1_OVC1_End_Point_1										
CE-VID	End Point ID										
CVID1	UNI1_OVC1_End_Point										
CVID_Default	UNI1_OVC1_End_Point										
Test Procedure	Tester transmits double-tagged test frames mapped to OVC1 at ENNI1: CE-VLAN ID is not 0										
Expected Results	All test frames are received at UNI1: frames are untagged.										
Verdict	PASS, FAIL, or INCONCLUSIVE										

6.27 Determination of CoS ID on UNI – OVC End Point at UNI

ABSTRACT TEST CASES FOR ENNI PHASE 1													
Test Case ID	OVC_per_UNI_ATTRIBUTES.R71.1												
Reference Document Source	MEF 26, R71												
Test Status	Conditional Mandatory												
Requirement	When the Class of Service Identifier is based on OVC End Point, all ingress Data Service Frames mapped to the same OVC End Point at the UNI MUST have the same Class of Service Identifier.												
Test Purpose	Verify that the Class of Service of all Service Frames received from a single UNI End Point on a UNI is the same, if Classifying based on OVC End Point is enabled.												
Conditions	Classifying based on OVC End Point = "Yes"												
Test Topology/OVC	<table border="1" style="margin-left: auto; margin-right: auto;"> <thead> <tr> <th>S-VID</th> <th>End Point ID</th> </tr> </thead> <tbody> <tr> <td>SVID14</td> <td>ENNI1_OVC10_End_Point_1</td> </tr> <tr> <td>SVID45</td> <td>ENNI1_OVC29_End_Point_1</td> </tr> </tbody> </table> <table border="1" style="margin-left: auto; margin-right: auto;"> <thead> <tr> <th>CE-VID</th> <th>End Point ID</th> </tr> </thead> <tbody> <tr> <td>CVID6</td> <td>UNI1_OVC10_End_Point</td> </tr> <tr> <td>CVID25</td> <td>UNI1_OVC29_End_Point</td> </tr> </tbody> </table>	S-VID	End Point ID	SVID14	ENNI1_OVC10_End_Point_1	SVID45	ENNI1_OVC29_End_Point_1	CE-VID	End Point ID	CVID6	UNI1_OVC10_End_Point	CVID25	UNI1_OVC29_End_Point
S-VID	End Point ID												
SVID14	ENNI1_OVC10_End_Point_1												
SVID45	ENNI1_OVC29_End_Point_1												
CE-VID	End Point ID												
CVID6	UNI1_OVC10_End_Point												
CVID25	UNI1_OVC29_End_Point												
Test Procedure	Tester transmits C-tagged test frames mapped to OVC10 at UNI1: C-tag PCP is set to each of the values in range [0..7]. Tester transmits C-tagged test frames mapped to OVC29 at UNI1: C-tag PCP is set to each of the values in range [0..7].												
Expected Results	All test frames sent over OVC10 at UNI1 are received at ENNI1, mapped to OVC10. None of the test frames sent over OVC29 at UNI1 are received at ENNI1, mapped to OVC29. NOTE: There is no condition on the PCP values of frames egressing on ENNI1 for this test.												
Verdict	PASS, FAIL, or INCONCLUSIVE												

6.28 Determination of CoS ID on UNI – C-Tag Priority Code Point

ABSTRACT TEST CASES FOR ENNI PHASE 1									
Test Case ID	OVC_per_UNI_ATTRIBUTES.R72.1								
Reference Document Source	MEF 26, R72								
Test Status	Conditional Mandatory								
Requirement	When the Class of Service Identifier is based on Priority Code Point field, the Class of Service Identifier for an ingress Data Service Frame at the UNI MUST be determined by the OVC End Point and non-overlapping sets of values of the PCP field in the C-Tag.								
Test Purpose	Verify that the Class of Service of a Service Frame on a UNI is determined by the non-overlapping sets of values of the C-Tag Priority Code Point, if the Number of UNI CoS is greater then one.								
Conditions	Number of UNI CoS > 1, Classifying based on C-Tag PCP = "Yes", Discard CoS at UNI = "Yes"								
Test Topology/OVC	<p>The diagram illustrates the test topology. Two Test Systems are connected to ENNI1 and UNI1 respectively. ENNI1 and UNI1 are connected to OVC11. OVC11 is connected to Operator MEN. Below the diagram are two tables:</p> <table border="1" style="display: inline-table; margin-right: 20px;"> <thead> <tr> <th>S-VID</th> <th>End Point ID</th> </tr> </thead> <tbody> <tr> <td>SVID15</td> <td>ENNI1_OVC11_End_Point_1</td> </tr> </tbody> </table> <table border="1" style="display: inline-table;"> <thead> <tr> <th>CE-VID</th> <th>End Point ID</th> </tr> </thead> <tbody> <tr> <td>CVID7</td> <td>UNI1_OVC11_End_Point</td> </tr> </tbody> </table>	S-VID	End Point ID	SVID15	ENNI1_OVC11_End_Point_1	CE-VID	End Point ID	CVID7	UNI1_OVC11_End_Point
S-VID	End Point ID								
SVID15	ENNI1_OVC11_End_Point_1								
CE-VID	End Point ID								
CVID7	UNI1_OVC11_End_Point								
Test Procedure	Tester transmits C-tagged test frames mapped to OVC11 at UNI1: C-tag PCP is set to each of the values 0 (“BestEffort”), 1, 2, 3, 4, 5, 6 and 7 (“Discard”).								
Expected Results	All test frames transmitted with C-tag PCP value 0 are received at ENNI1 and mapped to OVC11. Test frames transmitted with any other C-tag PCP values are not received at any External Interface. NOTE: The test procedure should not rely on egress PCP values at the ENNI but validate the streams using the test frame signature instead.								
Verdict	PASS, FAIL, or INCONCLUSIVE								

6.29 Determination of CoS ID on UNI – Service Frames Without C-Tag

ABSTRACT TEST CASES FOR ENNI PHASE 1											
Test Case ID	OVC_per_UNI_ATTRIBUTES.R73.1										
Reference Document Source	MEF 26, R73										
Test Status	Conditional Mandatory										
Requirement	When the Class of Service Identifier is based on Priority Code Point field, if the ingress frame does not contain a C-Tag, it MUST have the same Class of Service Identifier as an ingress frame with Priority Code Point field = 0 in the C-Tag.										
Test Purpose	Verify that the Class of Service of untagged Service Frames on a UNI is mapped to the same CoS as an ingress frame with the C-Tag Priority Code Point set to 0.										
Conditions	Classifying based on C-Tag PCP = "Yes" , Discard CoS at UNI = "Yes", Untagged frames at UNI = "Yes"										
Test Topology/OVC	<p>The diagram illustrates the test topology for OVC3. It shows two Test Systems connected to ENNI1 and UNI2. ENNI1 is connected to OVC3 via ENNI1_OVC3_End_Point_1. UNI2 is connected to OVC3 via UNI2_OVC3_End_Point. An Operator MEN is also connected to OVC3. Below the diagram are two tables:</p> <table border="1"> <thead> <tr> <th>S-VID</th> <th>End Point ID</th> </tr> </thead> <tbody> <tr> <td>SVID5</td> <td>ENNI1_OVC3_End_Point_1</td> </tr> </tbody> </table> <table border="1"> <thead> <tr> <th>CE-VID</th> <th>End Point ID</th> </tr> </thead> <tbody> <tr> <td>CVID31</td> <td>UNI2_OVC3_End_Point</td> </tr> <tr> <td>CVID_Default</td> <td>UNI2_OVC3_End_Point</td> </tr> </tbody> </table>	S-VID	End Point ID	SVID5	ENNI1_OVC3_End_Point_1	CE-VID	End Point ID	CVID31	UNI2_OVC3_End_Point	CVID_Default	UNI2_OVC3_End_Point
S-VID	End Point ID										
SVID5	ENNI1_OVC3_End_Point_1										
CE-VID	End Point ID										
CVID31	UNI2_OVC3_End_Point										
CVID_Default	UNI2_OVC3_End_Point										
Test Procedure	Tester transmits untagged and C-Tagged frames mapped to OVC3 at UNI1: PCP of C-tagged frames is set to each value from 0 to 7.										
Expected Results	Untagged test frames and test frames with PCP=0 are received at ENNI1, mapped to OVC3. Test frames transmitted with any other C-tag PCP values are not received at ENNI1. NOTE: The test procedure should not rely on egress PCP values at the ENNI but validate the streams using the test frame signature instead.										
Verdict	PASS, FAIL, or INCONCLUSIVE										

6.30 Determination of CoS ID on UNI – DSCP in IPv4

ABSTRACT TEST CASES FOR ENNI PHASE 1													
Test Case ID	OVC_per_UNI_ATTRIBUTES.R75.1												
Reference Document Source	MEF 26, R75												
Test Status	Conditional Mandatory												
Requirement	When the Class of Service Identifier is based on DSCP, the Class of Service Identifier for an ingress Data Service Frame at the UNI containing an IP packet MUST be determined by the OVC End Point and non-overlapping sets of values of the DSCP.												
Test Purpose	Verify that Class of Services at UNI of the ingress frames is determined by the non-overlapping sets of values of the DiffServ Code Points (DSCP) encoded in IPv4 ToS field, if the Number of UNI CoS is greater than one and Classifying based on DSCP in IPv4 are enabled.												
Conditions	Number of UNI CoS > 1, Classifying based on DSCP in IPv4 = "Yes", Discard CoS at UNI = "Yes"												
Test Topology/OVC	<table border="1" style="margin-top: 10px;"> <thead> <tr> <th>S-VID</th> <th>End Point ID</th> <th>CE-VID</th> <th>End Point ID</th> </tr> </thead> <tbody> <tr> <td>SVID6</td> <td>ENNI1_OVC4_End_Point_1</td> <td>CVID2</td> <td>UNI5_OVC4_End_Point</td> </tr> <tr> <td></td> <td></td> <td>CVID_Default</td> <td>UNI5_OVC4_End_Point</td> </tr> </tbody> </table>	S-VID	End Point ID	CE-VID	End Point ID	SVID6	ENNI1_OVC4_End_Point_1	CVID2	UNI5_OVC4_End_Point			CVID_Default	UNI5_OVC4_End_Point
S-VID	End Point ID	CE-VID	End Point ID										
SVID6	ENNI1_OVC4_End_Point_1	CVID2	UNI5_OVC4_End_Point										
		CVID_Default	UNI5_OVC4_End_Point										
Test Procedure	Tester transmits C-tagged and untagged test frames mapped to OVC4 at UNI5: frames contain IPv4 packets, C-tag PCP is set to 7 for C-tagged test frames, DSCP is set to each value from 0 to 63.												
Expected Results	All tagged and untagged test frames transmitted with DSCP value 0 are received at ENNI1, and mapped to OVC4. No other test frames are received at ENNI1.												
Verdict	PASS, FAIL, or INCONCLUSIVE												



6.31 Determination of CoS ID on UNI – DSCP in IPv6

ABSTRACT TEST CASES FOR ENNI PHASE 1											
Test Case ID	OVC_per_UNI_ATTRIBUTES.R75.2										
Reference Document Source	MEF 26, R75										
Test Status	Conditional Mandatory										
Requirement	When the Class of Service Identifier is based on DSCP, the Class of Service Identifier for an ingress Data Service Frame at the UNI containing an IP packet MUST be determined by the OVC End Point and non-overlapping sets of values of the DSCP.										
Test Purpose	Verify that Class of Services at UNI of the ingress frames is determined by the non-overlapping sets of values of the DiffServ Code Points (DSCP) encoded in IPv6 Traffic Class octet, if the Number of UNI CoS is greater than one and Classifying based on DSCP in IPv6 are enabled.										
Conditions	Number of UNI CoS > 1, Classifying based on DSCP in IPv6 = "Yes", Discard CoS at UNI = "Yes"										
Test Topology/OVC	<table border="1" style="margin-top: 10px;"> <thead> <tr> <th>S-VID</th> <th>End Point ID</th> </tr> </thead> <tbody> <tr> <td>SVID6</td> <td>ENNI1_OVC4_End_Point_1</td> </tr> </tbody> </table> <table border="1" style="margin-top: 10px;"> <thead> <tr> <th>CE-VID</th> <th>End Point ID</th> </tr> </thead> <tbody> <tr> <td>CVID2</td> <td>UNI5_OVC4_End_Point</td> </tr> <tr> <td>CVID_Default</td> <td>UNI5_OVC4_End_Point</td> </tr> </tbody> </table>	S-VID	End Point ID	SVID6	ENNI1_OVC4_End_Point_1	CE-VID	End Point ID	CVID2	UNI5_OVC4_End_Point	CVID_Default	UNI5_OVC4_End_Point
S-VID	End Point ID										
SVID6	ENNI1_OVC4_End_Point_1										
CE-VID	End Point ID										
CVID2	UNI5_OVC4_End_Point										
CVID_Default	UNI5_OVC4_End_Point										
Test Procedure	Tester transmits C-tagged and untagged test frames mapped to OVC4 at UNI5: frames contain IPv6 packets, C-tag PCP is set to 7 for tagged test frames, DSCP is set to each value from 0 to 63.										
Expected Results	All tagged and untagged test frames transmitted with DSCP value 0 are received at ENNI1 and mapped to OVC4. No other test frames are received at ENNI1,										
Verdict	PASS, FAIL, or INCONCLUSIVE										

6.32 Determination of CoS ID on UNI – DSCP and Non-IP Service Frames

ABSTRACT TEST CASES FOR ENNI PHASE 1											
Test Case ID	OVC_per_UNI_ATTRIBUTES.R77.1										
Reference Document Source	MEF 26, R77										
Test Status	Conditional Mandatory										
Requirement	When the Class of Service Identifier is based on DSCP, each ingress Data Service Frame at the UNI not containing an IP packet and mapped to a given OVC End Point MUST have the same Class of Service Identifier with a value agreed upon by the Operator and the Service Provider.										
Test Purpose	Verify that the Class of Service of Service Frames on a UNI not containing an IP packet is mapped to the same CoS agreed upon by the Operator and the Service Provider.										
Conditions	Number of UNI OVC End Points > 0, (Classifying based on DSCP in IPv4 or Classifying based on DSCP in IPv6) = "Yes",										
Test Topology/OVC	<p>The diagram illustrates the test topology for OVC4. It shows two Test Systems connected to ENNI1 and UNI5. ENNI1 is connected to OVC4 via ENNI1_OVC4_End_Point_1. UNI5 is connected to OVC4 via UNI5_OVC4_End_Point. An Operator MEN is also connected to OVC4. Below the diagram are two tables:</p> <table border="1"> <thead> <tr> <th>S-VID</th> <th>End Point ID</th> </tr> </thead> <tbody> <tr> <td>SVID6</td> <td>ENNI1_OVC4_End_Point_1</td> </tr> </tbody> </table> <table border="1"> <thead> <tr> <th>CE-VID</th> <th>End Point ID</th> </tr> </thead> <tbody> <tr> <td>CVID2</td> <td>UNI5_OVC4_End_Point</td> </tr> <tr> <td>CVID_Default</td> <td>UNI5_OVC4_End_Point</td> </tr> </tbody> </table>	S-VID	End Point ID	SVID6	ENNI1_OVC4_End_Point_1	CE-VID	End Point ID	CVID2	UNI5_OVC4_End_Point	CVID_Default	UNI5_OVC4_End_Point
S-VID	End Point ID										
SVID6	ENNI1_OVC4_End_Point_1										
CE-VID	End Point ID										
CVID2	UNI5_OVC4_End_Point										
CVID_Default	UNI5_OVC4_End_Point										
Test Procedure	Tester transmits C-tagged and untagged test frames mapped to OVC4 at UNI5: frames contain non-IP and IP packets, PCP of tagged frames is set to each value from 0 to 7, DSCP value of IP packets is set to each value from 0 to 63.										
Expected Results	All non-IP and IP packets transmitted with DSCP value 0 are received at ENNI1, and mapped to OVC4. No other test frames are received at ENNI1.										
Verdict	PASS, FAIL, or INCONCLUSIVE										

## 7 Test Group: Protection

For sake of simplicity, all test cases in this section use the same topology with one protected ENNI and one UNI, and a single point-to-point OVC configured between the ENNI and UNI. In some test cases, the test procedure is limited to behavior at the ENNI. For these cases, the expected results do not require configuration of OVC, UNI and test traffic across the OVC.

7.1 Link Aggregation on ENNI with Two Links

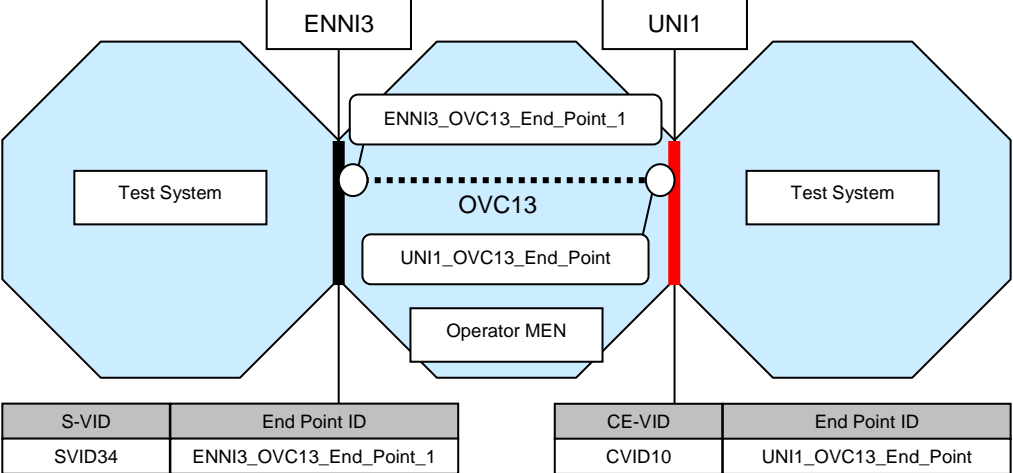
ABSTRACT TEST CASES FOR ENNI PHASE 1									
Test Case ID	ENNI_PROTECTION.R1.1								
Reference Document Source	MEF 26, Requirement R1								
Test Type	Conformance								
Test Status	Conditional Mandatory								
Requirement	When there are two physical links in the ENNI, an ENNI-Ni MUST be capable of implementing Link Aggregation as in Clause 43.6.1 of [5] with one Link Aggregation Group (LAG) across the ports supporting an instance of ENNI and with one link in active mode and the other in standby mode.								
Test Purpose	Verify that an ENNI equipped with two links activates Link Aggregation. Verify that both links are configured in the same LAG.								
Conditions	Protection Mechanism = "Yes"								
Test Topology/OVC	 <table border="1" data-bbox="443 1099 903 1167"> <thead> <tr> <th>S-VID</th> <th>End Point ID</th> </tr> </thead> <tbody> <tr> <td>SVID34</td> <td>ENNI3_OVC13_End_Point_1</td> </tr> </tbody> </table> <table border="1" data-bbox="999 1099 1461 1167"> <thead> <tr> <th>CE-VID</th> <th>End Point ID</th> </tr> </thead> <tbody> <tr> <td>CVID10</td> <td>UNI1_OVC13_End_Point</td> </tr> </tbody> </table>	S-VID	End Point ID	SVID34	ENNI3_OVC13_End_Point_1	CE-VID	End Point ID	CVID10	UNI1_OVC13_End_Point
S-VID	End Point ID								
SVID34	ENNI3_OVC13_End_Point_1								
CE-VID	End Point ID								
CVID10	UNI1_OVC13_End_Point								
Test Procedure	Tester listens at the links of ENNI3.								
Expected Results	LACPDU's are received at both links of ENNI3: Actor_State.Aggregation flag is set to TRUE, Actor_Key value is equal in all LACPDU's.								
Verdict	PASS, FAIL, or INCONCLUSIVE								

7.2 Basic Interconnection: LACP

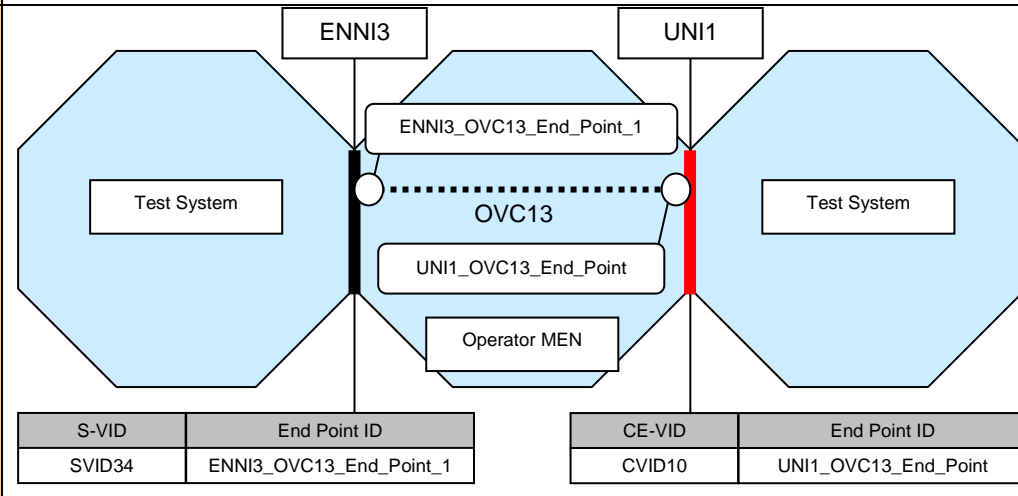
ABSTRACT TEST CASES FOR ENNI PHASE 1									
Test Case ID	ENNI_PROTECTION.R2.1								
Reference Document Source	MEF 26, Requirement R2								
Test Type	Conformance								
Test Status	Conditional Mandatory								
Requirement	When Link Aggregation is used at the ENNI, LACP MUST be used by each ENNI-Ni per [5].								
Test Purpose	Verify that the Operator MEN component with ENNI functionality sends LACPDU at each link on the protected ENNI to initiate the link aggregation.								
Conditions	LAG = "Yes"								
Test Topology/OVC	 <table border="1" data-bbox="414 1030 877 1108"> <thead> <tr> <th>S-VID</th> <th>End Point ID</th> </tr> </thead> <tbody> <tr> <td>SVID34</td> <td>ENNI3_OVC13_End_Point_1</td> </tr> </tbody> </table> <table border="1" data-bbox="973 1030 1436 1108"> <thead> <tr> <th>CE-VID</th> <th>End Point ID</th> </tr> </thead> <tbody> <tr> <td>CVID10</td> <td>UNI1_OVC13_End_Point</td> </tr> </tbody> </table>	S-VID	End Point ID	SVID34	ENNI3_OVC13_End_Point_1	CE-VID	End Point ID	CVID10	UNI1_OVC13_End_Point
S-VID	End Point ID								
SVID34	ENNI3_OVC13_End_Point_1								
CE-VID	End Point ID								
CVID10	UNI1_OVC13_End_Point								
Test Procedure	Tester listens for up to (LACP process time + LACPDU listen time + Slow_Periodic_Time) seconds at the links of ENNI3.								
Expected Results	At least one LACPDU must be received at each of the links of ENNI3.								
Verdict	PASS, FAIL, or INCONCLUSIVE								

7.3 Active Link in the Protection LAG

ABSTRACT TEST CASES FOR ENNI PHASE 1									
Test Case ID	ENNI_PROTECTION.R1.2								
Reference Document Source	MEF 26, Requirement R1								
Test Type	Conformance								
Test Status	Conditional Mandatory								
Requirement	When there are two physical links in the ENNI, an ENNI-Ni MUST be capable of implementing Link Aggregation as in Clause 43.6.1 of [5] with one Link Aggregation Group (LAG) across the ports supporting an instance of ENNI and with one link in active mode and the other in standby mode.								
Test Purpose	Verify that in the Link Aggregation Group configured in the ENNI contains one active link.								
Conditions	LAG = "Yes"								
Test Topology/OVC	<table border="1" style="width: 100%; margin-top: 10px;"> <thead> <tr> <th>S-VID</th> <th>End Point ID</th> <th>CE-VID</th> <th>End Point ID</th> </tr> </thead> <tbody> <tr> <td>SVID34</td> <td>ENNI3_OVC13_End_Point_1</td> <td>CVID10</td> <td>UNI1_OVC13_End_Point</td> </tr> </tbody> </table>	S-VID	End Point ID	CE-VID	End Point ID	SVID34	ENNI3_OVC13_End_Point_1	CVID10	UNI1_OVC13_End_Point
S-VID	End Point ID	CE-VID	End Point ID						
SVID34	ENNI3_OVC13_End_Point_1	CVID10	UNI1_OVC13_End_Point						
Test Procedure	Tester transmits a LACPDU (Request for enabling Distribution) at the link of ENNI3 configured as Active. Tester sends test frames Flow Definition1 (Default traffic flow definition) at UNI1 and at the link of ENNI3 configured as Active: the test frames are mapped to OVC13.								
Expected Results	All test frames sent at ENNI3 are received at UNI1.								
Verdict	PASS, FAIL, or INCONCLUSIVE								

### 7.4 Passive Link in the Protection LAG

ABSTRACT TEST CASES FOR ENNI PHASE 1									
Test Case ID	ENNI_PROTECTION.R1.3								
Reference Document Source	MEF 26, Requirement R1								
Test Type	Conformance								
Test Status	Conditional Mandatory								
Requirement	When there are two physical links in the ENNI, an ENNI-Ni MUST be capable of implementing Link Aggregation as in Clause 43.6.1 of [5] with one Link Aggregation Group (LAG) across the ports supporting an instance of ENNI and with one link in active mode and the other in standby mode.								
Test Purpose	Verify that in the Link Aggregation Group configured in the ENNI contains one passive (standby) link.								
Conditions	LAG = "Yes"								
Test Topology/OVC	<table border="1" style="width: 100%; margin-top: 10px;"> <thead> <tr> <th>S-VID</th> <th>End Point ID</th> <th>CE-VID</th> <th>End Point ID</th> </tr> </thead> <tbody> <tr> <td>SVID34</td> <td>ENNI3_OVC13_End_Point_1</td> <td>CVID10</td> <td>UNI1_OVC13_End_Point</td> </tr> </tbody> </table>	S-VID	End Point ID	CE-VID	End Point ID	SVID34	ENNI3_OVC13_End_Point_1	CVID10	UNI1_OVC13_End_Point
S-VID	End Point ID	CE-VID	End Point ID						
SVID34	ENNI3_OVC13_End_Point_1	CVID10	UNI1_OVC13_End_Point						
Test Procedure	Tester transmits a LACPDU (Request for disabling Collection and Distribution) at the link of ENNI3 configured as Standby. Tester transmits test frames Flow Definition1 (Default traffic flow definition) at UNI1 and at the link of ENNI3 configured as Standby: the test frames are mapped to OVC13.								
Expected Results	Test frames are not received on the standby or active link of ENNI3 or at UNI1.								
Verdict	PASS, FAIL, or INCONCLUSIVE								

7.5 Aggregator Parser-forward valid frames (Collection)

ABSTRACT TEST CASES FOR ENNI PHASE 1									
Test Case ID	LA_OPERATION.APM3.1								
Reference Document Source	IEEE Std 802.3 – 2005, Clause 43.2.7; Protocol implementation conformance statement (PICS) proforma for Clause 43, Item APM3								
Test Type	Conformance								
Test Status	Conditional Mandatory								
Requirement	Function specified by state diagram shown in Figure 43–5 and associated definitions in 43.2.7.1								
Test Purpose	Verify that the Operator MEN component with ENNI functionality doesn't forward any Slow Protocol PDUs with invalid Protocol Subtype value or LACP/Marker PDUs to the EIs.								
Conditions	LAG = "Yes"								
Test Topology/OVC	<table border="1" style="margin-top: 10px;"> <thead> <tr> <th>S-VID</th> <th>End Point ID</th> </tr> </thead> <tbody> <tr> <td>SVID34</td> <td>ENNI3_OVC13_End_Point_1</td> </tr> </tbody> </table> <table border="1" style="margin-top: 10px;"> <thead> <tr> <th>CE-VID</th> <th>End Point ID</th> </tr> </thead> <tbody> <tr> <td>CVID10</td> <td>UNI1_OVC13_End_Point</td> </tr> </tbody> </table>	S-VID	End Point ID	SVID34	ENNI3_OVC13_End_Point_1	CE-VID	End Point ID	CVID10	UNI1_OVC13_End_Point
S-VID	End Point ID								
SVID34	ENNI3_OVC13_End_Point_1								
CE-VID	End Point ID								
CVID10	UNI1_OVC13_End_Point								
Test Procedure	Tester transmits a LACPDU (Request for enabling Collection/disabling Distribution) at each link of ENNI3 Tester transmits test frames Flow Definition2 (Traffic flow for negative test cases) mapped to OVC13 at ENNI3								
Expected Results	Slow Protocol PDUs with invalid Protocol Subtype value or LACP/Marker PDUs are not received on the standby or active link of ENNI3 or at UNI1.								
Verdict	PASS, FAIL, or INCONCLUSIVE								



7.6 Aggregator Parser–discard frames (No Collection)

ABSTRACT TEST CASES FOR ENNI PHASE 1									
Test Case ID	LA_OPERATION.APM4.1								
Reference Document Source	IEEE Std 802.3 – 2005, Clause 43.2.7; Protocol implementation conformance statement (PICS) proforma for Clause 43, Item APM4								
Test Type	Conformance								
Test Status	Conditional Mandatory								
Requirement	Function specified by state diagram shown in Figure 43–5 and associated definitions in 43.2.7.1 The Aggregator Parser shall pass all other frames to the Frame Collector for passage to the MAC Client only when the port state is Collecting; otherwise such frames shall be discarded.								
Test Purpose	Verify that the Operator MEN component with ENNI functionality, when the ports on the protected ENNI are NOT in the Collecting state, doesn't forward any frames from the ENNI to the EIs.								
Conditions	LAG = "Yes"								
Test Topology/OVC	<table border="1" style="width: 100%; margin-top: 10px;"> <thead> <tr> <th>S-VID</th> <th>End Point ID</th> <th>CE-VID</th> <th>End Point ID</th> </tr> </thead> <tbody> <tr> <td>SVID34</td> <td>ENNI3_OVC13_End_Point_1</td> <td>CVID10</td> <td>UNI1_OVC13_End_Point</td> </tr> </tbody> </table>	S-VID	End Point ID	CE-VID	End Point ID	SVID34	ENNI3_OVC13_End_Point_1	CVID10	UNI1_OVC13_End_Point
S-VID	End Point ID	CE-VID	End Point ID						
SVID34	ENNI3_OVC13_End_Point_1	CVID10	UNI1_OVC13_End_Point						
Test Procedure	Tester transmits a LACPDU (Request for disabling Collection and Distribution) at each link of ENNI3 Tester transmits test frames Flow Definition2 (Traffic flow for negative test cases) mapped to OVC13 at ENNI3								
Expected Results	Test frames are not received on the standby or active link of ENNI3 or at UNI1.								
Verdict	PASS, FAIL, or INCONCLUSIVE								

7.7 Aggregator Parser-forward Marker PDUs (Collection)

ABSTRACT TEST CASES FOR ENNI PHASE 1									
Test Case ID	LA_OPERATION.APM3.2								
Reference Document Source	IEEE Std 802.3 – 2005, Clause 43.2.7; Protocol implementation conformance statement (PICS) proforma for Clause 43, Item APM3								
Test Type	Conformance								
Test Status	Conditional Mandatory								
Requirement	Function specified by state diagram shown in Figure 43–5 and associated definitions in 43.2.7.1								
Test Purpose	Verify that the Operator MEN component with ENNI functionality, when the ports on the protected ENNI are in the Collecting state, forwards Marker PDUs from the ENNI to the Marker Responder. On receipt of a Marker PDU the Marker Responder sends a Marker PDU for answering.								
Conditions	LAG = "Yes"								
Test Topology/OVC	<table border="1" style="width: 100%; margin-top: 10px;"> <thead> <tr> <th>S-VID</th> <th>End Point ID</th> <th>CE-VID</th> <th>End Point ID</th> </tr> </thead> <tbody> <tr> <td>SVID34</td> <td>ENNI3_OVC13_End_Point_1</td> <td>CVID10</td> <td>UNI1_OVC13_End_Point</td> </tr> </tbody> </table>	S-VID	End Point ID	CE-VID	End Point ID	SVID34	ENNI3_OVC13_End_Point_1	CVID10	UNI1_OVC13_End_Point
S-VID	End Point ID	CE-VID	End Point ID						
SVID34	ENNI3_OVC13_End_Point_1	CVID10	UNI1_OVC13_End_Point						
Test Procedure	Tester transmits a LACPDU (Request for enabling Collection/disabling Distribution) at each link of ENNI3 Tester transmits a Marker PDU at each link of ENNI3								
Expected Results	Marker PDU is received at the link of ENNI3 configured as Active. Marker PDU is not received at the link of ENNI3 configured as Standby.								
Verdict	PASS, FAIL, or INCONCLUSIVE								

7.8 Aggregator Parser-forward Marker PDUs (No Collection)

ABSTRACT TEST CASES FOR ENNI PHASE 1									
Test Case ID	LA_OPERATION.APM3.4								
Reference Document Source	IEEE Std 802.3 – 2005, Clause 43.2.7; Protocol implementation conformance statement (PICS) proforma for Clause 43, Item APM3								
Test Type	Conformance								
Test Status	Conditional Mandatory								
Requirement	Function specified by state diagram shown in Figure 43–5 and associated definitions in 43.2.7.1								
Test Purpose	Verify that the Operator MEN component with ENNI functionality, when the ports on the protected ENNI are NOT in the Collecting state, forwards Marker PDUs from the ENNI to the Marker Responder. On receipt of a Marker PDU the Marker Responder should send a Marker PDU for answering.								
Conditions	LAG = "Yes"								
Test Topology/OVC	<table border="1" style="width: 100%; margin-top: 10px;"> <tr> <td style="width: 50%; text-align: center;">S-VID</td> <td style="width: 50%; text-align: center;">End Point ID</td> </tr> <tr> <td style="text-align: center;">SVID34</td> <td style="text-align: center;">ENNI3_OVC13_End_Point_1</td> </tr> </table> <table border="1" style="width: 100%; margin-top: 10px;"> <tr> <td style="width: 50%; text-align: center;">CE-VID</td> <td style="width: 50%; text-align: center;">End Point ID</td> </tr> <tr> <td style="text-align: center;">CVID10</td> <td style="text-align: center;">UNI1_OVC13_End_Point</td> </tr> </table>	S-VID	End Point ID	SVID34	ENNI3_OVC13_End_Point_1	CE-VID	End Point ID	CVID10	UNI1_OVC13_End_Point
S-VID	End Point ID								
SVID34	ENNI3_OVC13_End_Point_1								
CE-VID	End Point ID								
CVID10	UNI1_OVC13_End_Point								
Test Procedure	Tester transmits a LACPDU (Request for enabling Collection/disabling Distribution) at each link of ENNI3 Tester transmits Marker PDU at each link of ENNI3								
Expected Results	Marker PDU is received at the link of ENNI3 configured as Active. Marker PDU is not received at the link of ENNI3 configured as Standby.								
Verdict	PASS, FAIL, or INCONCLUSIVE								

7.9 Aggregator Parser–discard invalid Marker PDUs–inopportune

ABSTRACT TEST CASES FOR ENNI PHASE 1									
Test Case ID	LA_OPERATION.APM3.6								
Reference Document Source	IEEE Std 802.3 – 2005, Clause 43.2.7; Protocol implementation conformance statement (PICS) proforma for Clause 43, Item APM3								
Test Type	Conformance								
Test Status	Conditional Mandatory								
Requirement	Function specified by state diagram shown in Figure 43–5 and associated definitions in 43.2.7.1								
Test Purpose	Verify that the Operator MEN component with ENNI functionality discards invalid Marker PDUs received at ENNI3.								
Conditions	LAG = "Yes"								
Test Topology/OVC	<p>The diagram illustrates a network topology for testing. Two Test Systems are connected to a central OVC13. The left Test System is connected to ENNI3, which is further connected to SVID34. The right Test System is connected to UNI1, which is further connected to CVID10. The OVC13 has two end points: ENNI3_OVC13_End_Point_1 and UNI1_OVC13_End_Point. An Operator MEN component is also shown connected to the OVC13. Below the diagram are two tables:</p> <table border="1"> <thead> <tr> <th>S-VID</th> <th>End Point ID</th> </tr> </thead> <tbody> <tr> <td>SVID34</td> <td>ENNI3_OVC13_End_Point_1</td> </tr> </tbody> </table> <table border="1"> <thead> <tr> <th>CE-VID</th> <th>End Point ID</th> </tr> </thead> <tbody> <tr> <td>CVID10</td> <td>UNI1_OVC13_End_Point</td> </tr> </tbody> </table>	S-VID	End Point ID	SVID34	ENNI3_OVC13_End_Point_1	CE-VID	End Point ID	CVID10	UNI1_OVC13_End_Point
S-VID	End Point ID								
SVID34	ENNI3_OVC13_End_Point_1								
CE-VID	End Point ID								
CVID10	UNI1_OVC13_End_Point								
Test Procedure	Tester transmits a LACPDU (Request for disabling Collection and Distribution) at each link of ENNI3 Tester transmits a Marker PDU at each link of ENNI3								
Expected Results	Marker PDU is not received on the standby or active link of ENNI3 or at UNI1.								
Verdict	PASS, FAIL, or INCONCLUSIVE								

7.10 Aggregator Multiplexer–forward Marker PDU (No Distribution)

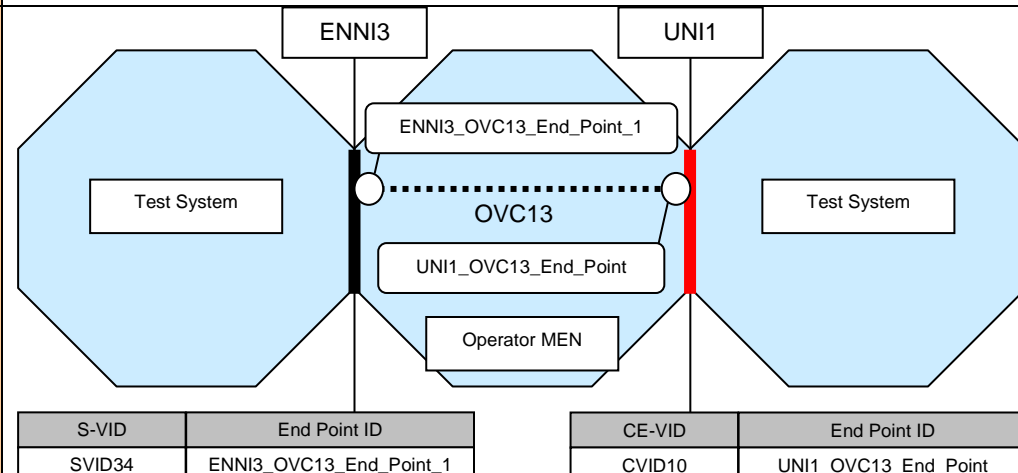
ABSTRACT TEST CASES FOR ENNI PHASE 1									
Test Case ID	LA_OPERATION.APM1.1								
Reference Document Source	IEEE Std 802.3 – 2005, Clause 43.2.7; Protocol implementation conformance statement (PICS) proforma for Clause 43, Item APM1								
Test Type	Conformance								
Test Status	Conditional Mandatory								
Requirement	On transmission, the Aggregator Multiplexer shall provide transparent pass-through of frames submitted by the Marker Responder and optional Marker Generator to the port specified in the transmission request.								
Test Purpose	Verify that the Operator MEN component with ENNI functionality, when the ports on the protected ENNI are NOT in the Distributing state, forwards Marker PDUs submitted by the Marker Responder to the ENNI.								
Conditions	LAG = "Yes"								
Test Topology/OVC	 <table border="1" data-bbox="414 1097 877 1164"> <thead> <tr> <th>S-VID</th> <th>End Point ID</th> </tr> </thead> <tbody> <tr> <td>SVID34</td> <td>ENNI3_OVC13_End_Point_1</td> </tr> </tbody> </table> <table border="1" data-bbox="973 1097 1436 1164"> <thead> <tr> <th>CE-VID</th> <th>End Point ID</th> </tr> </thead> <tbody> <tr> <td>CVID10</td> <td>UNI1_OVC13_End_Point</td> </tr> </tbody> </table>	S-VID	End Point ID	SVID34	ENNI3_OVC13_End_Point_1	CE-VID	End Point ID	CVID10	UNI1_OVC13_End_Point
S-VID	End Point ID								
SVID34	ENNI3_OVC13_End_Point_1								
CE-VID	End Point ID								
CVID10	UNI1_OVC13_End_Point								
Test Procedure	Tester transmits a LACPDU (Request for enabling Collection/disabling Distribution) at each link of ENNI3. Tester transmits a Marker PDU at each link of ENNI3.								
Expected Results	Marker PDU is received at the link of ENNI3 configured as Active. Marker PDU is not received at the link of ENNI3 configured as Standby.								
Verdict	PASS, FAIL, or INCONCLUSIVE								

7.11 Aggregator Multiplexer– forward Marker PDU (Distribution)

ABSTRACT TEST CASES FOR ENNI PHASE 1									
Test Case ID	LA_OPERATION.APM1.3								
Reference Document Source	IEEE Std 802.3 – 2005, Clause 43.2.7; Protocol implementation conformance statement (PICS) proforma for Clause 43, Item APM1								
Test Type	Conformance								
Test Status	Conditional Mandatory								
Requirement	On transmission, the Aggregator Multiplexer shall provide transparent pass-through of frames submitted by the Marker Responder and optional Marker Generator to the port specified in the transmission request.								
Test Purpose	Verify that the Operator MEN component with ENNI functionality, when the ports on the protected ENNI are in the Distributing state, forwards Marker PDUs submitted by the Marker Responder to the ENNI.								
Conditions	LAG = "Yes"								
Test Topology/OVC	<table border="1" style="margin-top: 10px;"> <thead> <tr> <th>S-VID</th> <th>End Point ID</th> </tr> </thead> <tbody> <tr> <td>SVID34</td> <td>ENNI3_OVC13_End_Point_1</td> </tr> </tbody> </table> <table border="1" style="margin-top: 10px;"> <thead> <tr> <th>CE-VID</th> <th>End Point ID</th> </tr> </thead> <tbody> <tr> <td>CVID10</td> <td>UNI1_OVC13_End_Point</td> </tr> </tbody> </table>	S-VID	End Point ID	SVID34	ENNI3_OVC13_End_Point_1	CE-VID	End Point ID	CVID10	UNI1_OVC13_End_Point
S-VID	End Point ID								
SVID34	ENNI3_OVC13_End_Point_1								
CE-VID	End Point ID								
CVID10	UNI1_OVC13_End_Point								
Test Procedure	Tester transmits a LACPDU (Request for enabling Distribution) at each link of ENNI3. Tester transmits a Marker PDU at each link of ENNI3.								
Expected Results	Marker PDU is received at the link of ENNI3 configured as Active. Marker PDU is not received at the link of ENNI3 configured as Standby.								
Verdict	PASS, FAIL, or INCONCLUSIVE								

7.12 Aggregator Multiplexer–forward frames (Distribution)

ABSTRACT TEST CASES FOR ENNI PHASE 1									
Test Case ID	LA_OPERATION.APM1.5								
Reference Document Source	IEEE Std 802.3 – 2005, Clause 43.2.7; Protocol implementation conformance statement (PICS) proforma for Clause 43, Item APM1								
Test Type	Conformance								
Test Status	Conditional Mandatory								
Requirement	The Aggregator Multiplexer shall provide transparent pass-through of frames submitted by the Frame Distributor to the port specified in the transmission request only when the port state is Distributing;								
Test Purpose	Verify that the Operator MEN component with ENNI functionality, when the ports on the protected ENNI are in the Distributing state, forwards frames from the EIs to the ENNI.								
Conditions	LAG = "Yes"								
Test Topology/OVC	<table border="1" style="margin-top: 10px;"> <thead> <tr> <th>S-VID</th> <th>End Point ID</th> </tr> </thead> <tbody> <tr> <td>SVID34</td> <td>ENNI3_OVC13_End_Point_1</td> </tr> </tbody> </table> <table border="1" style="margin-top: 10px;"> <thead> <tr> <th>CE-VID</th> <th>End Point ID</th> </tr> </thead> <tbody> <tr> <td>CVID10</td> <td>UNI1_OVC13_End_Point</td> </tr> </tbody> </table>	S-VID	End Point ID	SVID34	ENNI3_OVC13_End_Point_1	CE-VID	End Point ID	CVID10	UNI1_OVC13_End_Point
S-VID	End Point ID								
SVID34	ENNI3_OVC13_End_Point_1								
CE-VID	End Point ID								
CVID10	UNI1_OVC13_End_Point								
Test Procedure	Tester transmits a LACPDU (Request for enabling Distribution) at each link of ENNI3. Tester transmits test frames Flow Definition1 (Default traffic flow definition) mapped to OVC13 at UNI1.								
Expected Results	All test frames are received at ENNI3.								
Verdict	PASS, FAIL, or INCONCLUSIVE								

7.13 Aggregator Multiplexer–discard frames (No Distribution)

ABSTRACT TEST CASES FOR ENNI PHASE 1									
Test Case ID	LA_OPERATION.APM2.1								
Reference Document Source	IEEE Std 802.3 – 2005, Clause 43.2.7; Protocol implementation conformance statement (PICS) proforma for Clause 43, Item APM2								
Test Type	Conformance								
Test Status	Conditional Mandatory								
Requirement	The Aggregator Multiplexer shall provide transparent pass-through of frames submitted by the Frame Distributor to the port specified in the transmission request only when the port state is Distributing; Otherwise, such frames shall be discarded								
Test Purpose	Verify that the Operator MEN component with ENNI functionality, when the ports on the protected ENNI are NOT in the Distributing state, doesn't forward any frames from the EIs to the ENNI.								
Conditions	LAG = "Yes"								
Test Topology/OVC	<table border="1" style="width: 100%; margin-top: 10px;"> <tr> <td style="width: 50%; text-align: center;">S-VID</td> <td style="width: 50%; text-align: center;">End Point ID</td> </tr> <tr> <td style="text-align: center;">SVID34</td> <td style="text-align: center;">ENNI3_OVC13_End_Point_1</td> </tr> </table> <table border="1" style="width: 100%; margin-top: 10px;"> <tr> <td style="width: 50%; text-align: center;">CE-VID</td> <td style="width: 50%; text-align: center;">End Point ID</td> </tr> <tr> <td style="text-align: center;">CVID10</td> <td style="text-align: center;">UNI1_OVC13_End_Point</td> </tr> </table>	S-VID	End Point ID	SVID34	ENNI3_OVC13_End_Point_1	CE-VID	End Point ID	CVID10	UNI1_OVC13_End_Point
S-VID	End Point ID								
SVID34	ENNI3_OVC13_End_Point_1								
CE-VID	End Point ID								
CVID10	UNI1_OVC13_End_Point								
Test Procedure	Tester transmits a LACPDU (Request for enabling Collection/disabling Distribution) at each link of ENNI3. Tester transmits test frames Flow Definition1 (Default traffic flow definition) mapped to OVC13 at UNI1.								
Expected Results	Test frames are not received at ENNI3.								
Verdict	PASS, FAIL, or INCONCLUSIVE								

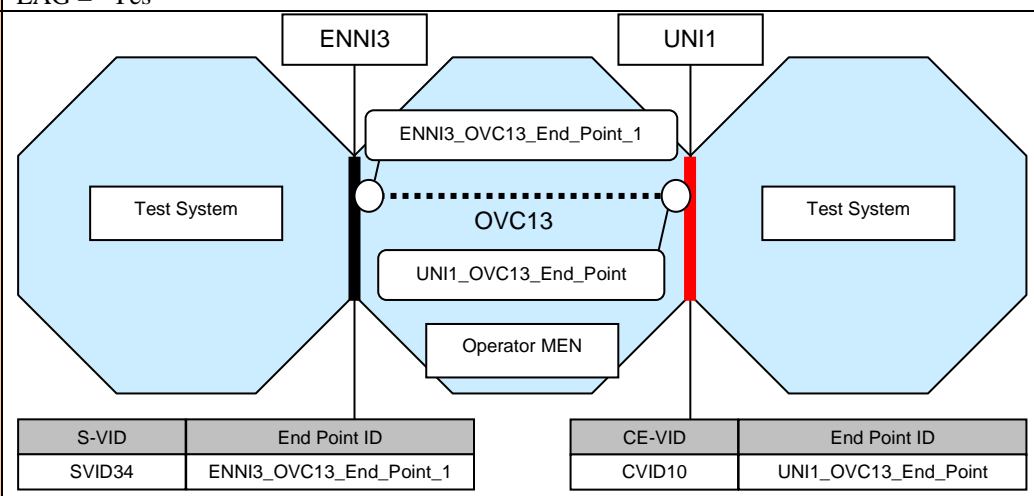

7.14 Control Parser-transparent pass-through (Distribution)

ABSTRACT TEST CASES FOR ENNI PHASE 1									
Test Case ID	LA_OPERATION.CMP1.1								
Reference Document Source	IEEE Std 802.3 – 2005, Clause 43.2.9; Protocol implementation conformance statement (PICS) proforma for Clause 43, Item CPM1								
Test Type	Conformance								
Test Status	Conditional Mandatory								
Requirement	Function specified in the state diagram shown in Figure 43–3 and associated definitions in 43.2.3.1								
Test Purpose	Verify that the Operator MEN component with ENNI functionality forwards frames transparently from the ENNI to the EIs.								
Conditions	LAG = "Yes"								
Test Topology/OVC	 <table border="1" data-bbox="414 1030 893 1120"> <thead> <tr> <th>S-VID</th> <th>End Point ID</th> </tr> </thead> <tbody> <tr> <td>SVID34</td> <td>ENNI3_OVC13_End_Point_1</td> </tr> </tbody> </table> <table border="1" data-bbox="973 1030 1452 1120"> <thead> <tr> <th>CE-VID</th> <th>End Point ID</th> </tr> </thead> <tbody> <tr> <td>CVID10</td> <td>UNI1_OVC13_End_Point</td> </tr> </tbody> </table>	S-VID	End Point ID	SVID34	ENNI3_OVC13_End_Point_1	CE-VID	End Point ID	CVID10	UNI1_OVC13_End_Point
S-VID	End Point ID								
SVID34	ENNI3_OVC13_End_Point_1								
CE-VID	End Point ID								
CVID10	UNI1_OVC13_End_Point								
Test Procedure	Tester transmits a LACPDU (Request for enabling Distribution) at each link of ENNI3. Tester transmits test frames Flow Definition1 (Default traffic flow definition) mapped to OVC13 at each link of ENNI3.								
Expected Results	Test frames are received at UNI1: payload is unmodified.								
Verdict	PASS, FAIL, or INCONCLUSIVE								

7.15 Control Parser–LACPDU–inopportune

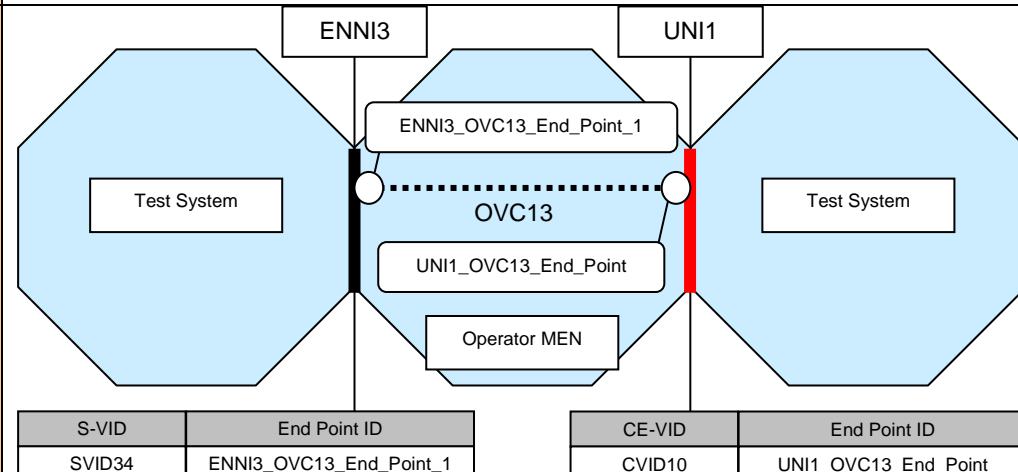
ABSTRACT TEST CASES FOR ENNI PHASE 1									
Test Case ID	LA_OPERATION.CMP2.2								
Reference Document Source	IEEE Std 802.3 – 2005, Clause 43.2.9; Protocol implementation conformance statement (PICS) proforma for Clause 43, Item CPM2								
Test Type	Conformance								
Test Status	Conditional Mandatory								
Requirement	Function specified by state diagram shown in Figure 43–6 and associated definitions in 43.2.9.1								
Test Purpose	Verify that the Operator MEN component with ENNI functionality is receiving LACPDU from the links not attached to the LAG. On receipt of a LACPDU (Request for informing current states) the Operator MEN component with ENNI functionality should send a LACPDU.								
Conditions	LAG = "Yes"								
Test Topology/OVC	 <table border="1" data-bbox="414 1097 877 1164"> <thead> <tr> <th>S-VID</th> <th>End Point ID</th> </tr> </thead> <tbody> <tr> <td>SVID34</td> <td>ENNI3_OVC13_End_Point_1</td> </tr> </tbody> </table> <table border="1" data-bbox="973 1097 1436 1164"> <thead> <tr> <th>CE-VID</th> <th>End Point ID</th> </tr> </thead> <tbody> <tr> <td>CVID10</td> <td>UNI1_OVC13_End_Point</td> </tr> </tbody> </table>	S-VID	End Point ID	SVID34	ENNI3_OVC13_End_Point_1	CE-VID	End Point ID	CVID10	UNI1_OVC13_End_Point
S-VID	End Point ID								
SVID34	ENNI3_OVC13_End_Point_1								
CE-VID	End Point ID								
CVID10	UNI1_OVC13_End_Point								
Test Procedure	Tester transmits a LACPDU (Request for informing current states) at each link of ENNI3.								
Expected Results	LACPDU is received at each link of ENNI3.								
Verdict	PASS, FAIL, or INCONCLUSIVE								

7.16 Control Parser–LACPDU

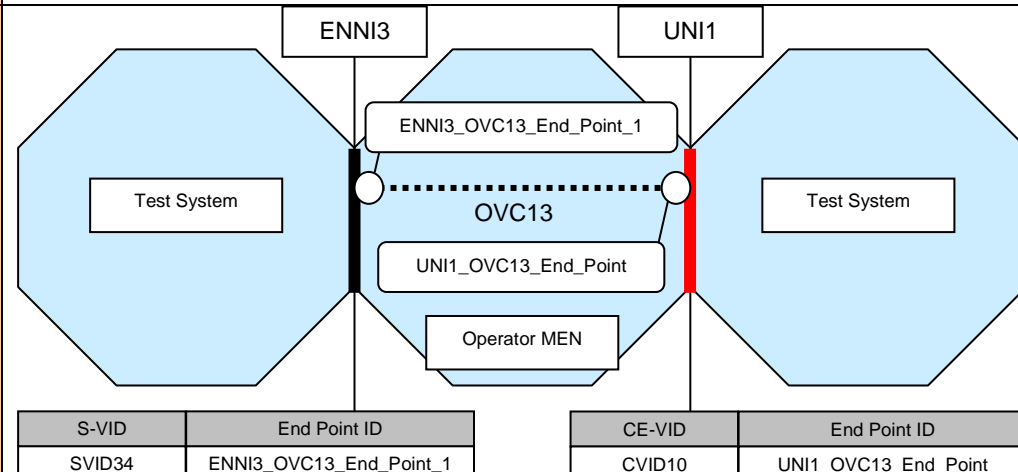
ABSTRACT TEST CASES FOR ENNI PHASE 1									
Test Case ID	LA_OPERATION.CMP2.3								
Reference Document Source	IEEE Std 802.3 – 2005, Clause 43.2.9; Protocol implementation conformance statement (PICS) proforma for Clause 43, Item CPM2								
Test Type	Conformance								
Test Status	Conditional Mandatory								
Requirement	Function specified by state diagram shown in Figure 43–6 and associated definitions in 43.2.9.1								
Test Purpose	Verify that the Operator MEN component with ENNI functionality is receiving LACPDU from the links attached to the LAG. On receipt of a LACPDU LACPDU (Request for informing current states) <b>Error! Reference source not found.</b> the Operator MEN component with ENNI functionality should send a LACPDU.								
Conditions	LAG = "Yes"								
Test Topology/OVC	 <table border="1" data-bbox="414 1097 877 1164"> <thead> <tr> <th>S-VID</th> <th>End Point ID</th> </tr> </thead> <tbody> <tr> <td>SVID34</td> <td>ENNI3_OVC13_End_Point_1</td> </tr> </tbody> </table> <table border="1" data-bbox="973 1097 1436 1164"> <thead> <tr> <th>CE-VID</th> <th>End Point ID</th> </tr> </thead> <tbody> <tr> <td>CVID10</td> <td>UNI1_OVC13_End_Point</td> </tr> </tbody> </table>	S-VID	End Point ID	SVID34	ENNI3_OVC13_End_Point_1	CE-VID	End Point ID	CVID10	UNI1_OVC13_End_Point
S-VID	End Point ID								
SVID34	ENNI3_OVC13_End_Point_1								
CE-VID	End Point ID								
CVID10	UNI1_OVC13_End_Point								
Test Procedure	Tester transmits a LACPDU (Request for informing current states) at each link of ENNI3.								
Expected Results	LACPDU is received at each link of ENNI3.								
Verdict	PASS, FAIL, or INCONCLUSIVE								

7.17 Control Multiplexer–forward LACPDU

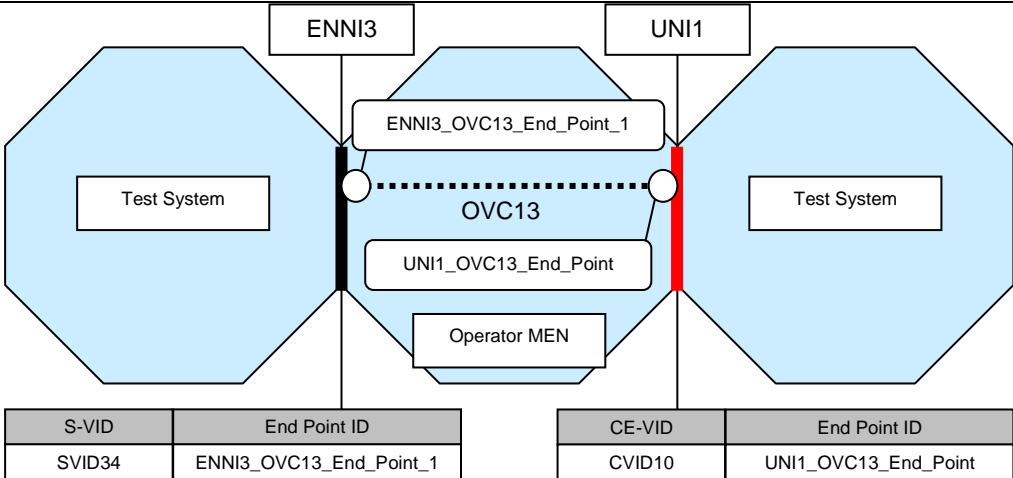
ABSTRACT TEST CASES FOR ENNI PHASE 1									
Test Case ID	LA_OPERATION.CMP1.1								
Reference Document Source	IEEE Std 802.3 – 2005, Clause 43.2.9; Protocol implementation conformance statement (PICS) proforma for Clause 43, Item CPM1								
Test Type	Conformance								
Test Status	Conditional Mandatory								
Requirement	On transmission, the Control Multiplexer shall provide transparent pass-through of frames submitted by the Aggregator and Link Aggregation Control Protocol to the port specified in the transmission request.								
Test Purpose	Verify that the Operator MEN component with ENNI functionality forwards LACPDU submitted from LACP to the ENNI.								
Conditions	LAG = "Yes"								
Test Topology/OVC	 <table border="1" data-bbox="427 1070 890 1142"> <thead> <tr> <th>S-VID</th> <th>End Point ID</th> </tr> </thead> <tbody> <tr> <td>SVID34</td> <td>ENNI3_OVC13_End_Point_1</td> </tr> </tbody> </table> <table border="1" data-bbox="986 1070 1444 1142"> <thead> <tr> <th>CE-VID</th> <th>End Point ID</th> </tr> </thead> <tbody> <tr> <td>CVID10</td> <td>UNI1_OVC13_End_Point</td> </tr> </tbody> </table>	S-VID	End Point ID	SVID34	ENNI3_OVC13_End_Point_1	CE-VID	End Point ID	CVID10	UNI1_OVC13_End_Point
S-VID	End Point ID								
SVID34	ENNI3_OVC13_End_Point_1								
CE-VID	End Point ID								
CVID10	UNI1_OVC13_End_Point								
Test Procedure	Tester transmits a LACPDU (Request for informing current states) at each link of ENNI3 Tester transmits test frames Flow Definition1 (Default traffic flow definition) mapped to OVC13 at each link of ENNI3								
Expected Results	LACPDU is received at each link of ENNI3								
Verdict	PASS, FAIL, or INCONCLUSIVE								

7.18 Control Multiplexer-transparent pass-through (Distribution)

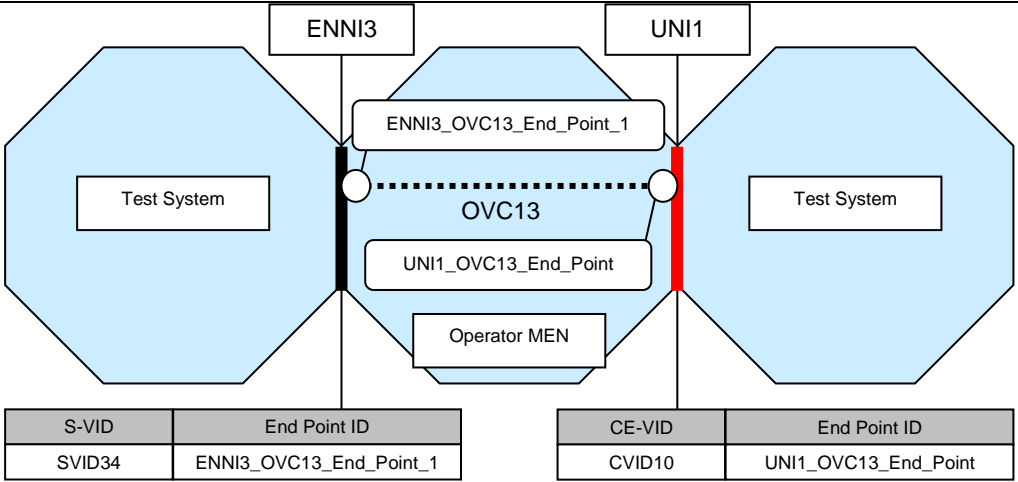
ABSTRACT TEST CASES FOR ENNI PHASE 1									
Test Case ID	LA_OPERATION.CMP1.2								
Reference Document Source	IEEE Std 802.3 – 2005, Clause 43.2.9; Protocol implementation conformance statement (PICS) proforma for Clause 43, Item CPM1								
Test Type	Conformance								
Test Status	Conditional Mandatory								
Requirement	On transmission, the Control Multiplexer shall provide transparent pass-through of frames submitted by the Aggregator and Link Aggregation Control Protocol to the port specified in the transmission request.								
Test Purpose	Verify that the Operator MEN component with ENNI functionality forwards frames transparently from the EIs to the ENNI.								
Conditions	LAG = "Yes"								
Test Topology/OVC	 <table border="1" data-bbox="427 1070 890 1146"> <thead> <tr> <th>S-VID</th> <th>End Point ID</th> </tr> </thead> <tbody> <tr> <td>SVID34</td> <td>ENNI3_OVC13_End_Point_1</td> </tr> </tbody> </table> <table border="1" data-bbox="986 1070 1449 1146"> <thead> <tr> <th>CE-VID</th> <th>End Point ID</th> </tr> </thead> <tbody> <tr> <td>CVID10</td> <td>UNI1_OVC13_End_Point</td> </tr> </tbody> </table>	S-VID	End Point ID	SVID34	ENNI3_OVC13_End_Point_1	CE-VID	End Point ID	CVID10	UNI1_OVC13_End_Point
S-VID	End Point ID								
SVID34	ENNI3_OVC13_End_Point_1								
CE-VID	End Point ID								
CVID10	UNI1_OVC13_End_Point								
Test Procedure	Tester transmits a LACPDU (Request for enabling Distribution) at each link of ENNI3 Tester transmits test frames Flow Definition1 (Default traffic flow definition) mapped to OVC13 at UNI1.								
Expected Results	Test frames are received at ENNI3: payload is unmodified.								
Verdict	PASS, FAIL, or INCONCLUSIVE								

7.19 Frame Distributor–Frames (Distribution)

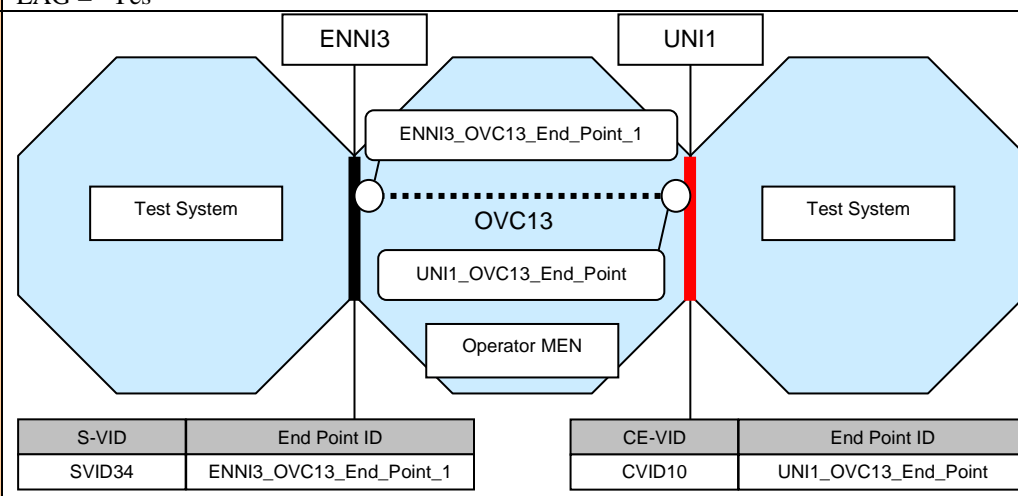
ABSTRACT TEST CASES FOR ENNI PHASE 1									
Test Case ID	LA_OPERATION.FD3.1								
Reference Document Source	IEEE Std 802.3 – 2005, Clause 43.2.4; Protocol implementation conformance statement (PICS) proforma for Clause 43, Item FD3								
Test Type	Conformance								
Test Status	Conditional Mandatory								
Requirement	Function as specified in the state diagram shown in Figure 43–4 and associated definitions in 43.2.3.4.1								
Test Purpose	Verify that the Operator MEN component with ENNI functionality distributes frames from the EIs to the ENNI.								
Conditions	LAG = "Yes"								
Test Topology/OVC	 <table border="1" data-bbox="414 1030 877 1120"> <thead> <tr> <th>S-VID</th> <th>End Point ID</th> </tr> </thead> <tbody> <tr> <td>SVID34</td> <td>ENNI3_OVC13_End_Point_1</td> </tr> </tbody> </table> <table border="1" data-bbox="973 1030 1436 1120"> <thead> <tr> <th>CE-VID</th> <th>End Point ID</th> </tr> </thead> <tbody> <tr> <td>CVID10</td> <td>UNI1_OVC13_End_Point</td> </tr> </tbody> </table>	S-VID	End Point ID	SVID34	ENNI3_OVC13_End_Point_1	CE-VID	End Point ID	CVID10	UNI1_OVC13_End_Point
S-VID	End Point ID								
SVID34	ENNI3_OVC13_End_Point_1								
CE-VID	End Point ID								
CVID10	UNI1_OVC13_End_Point								
Test Procedure	Tester transmits a LACPDU (Request for enabling Distribution) at each link of ENNI3. Tester transmits test frames Flow Definition1 (Default traffic flow definition) mapped to OVC13 at UNI1.								
Expected Results	All test frames are received at the link of ENNI3 configured as Active. Test frames are not received at the link of ENNI3 configured as Standby.								
Verdict	PASS, FAIL, or INCONCLUSIVE								

7.20 Frame Collector–Frames (Collection)

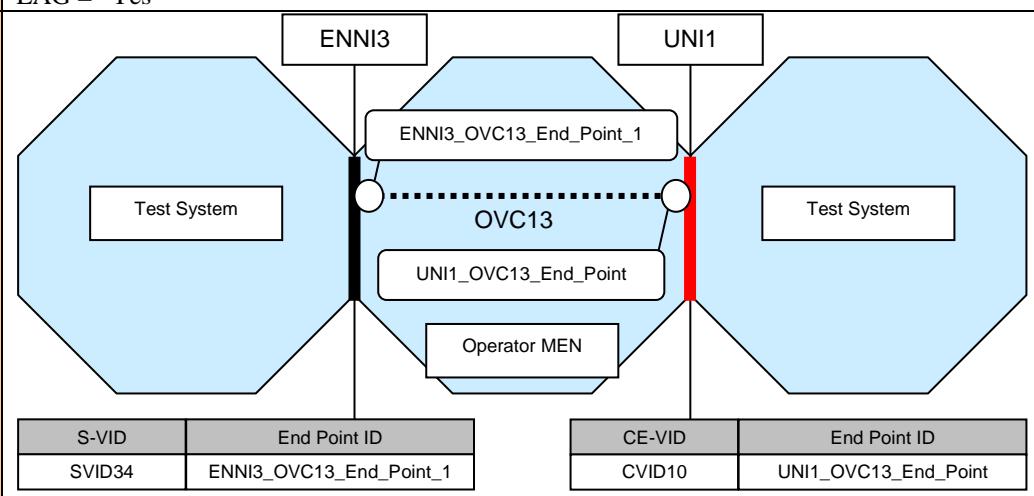
ABSTRACT TEST CASES FOR ENNI PHASE 1									
Test Case ID	LA_OPERATION.FC1.2								
Reference Document Source	IEEE Std 802.3 – 2005, Clause 43.2.3; Protocol implementation conformance statement (PICS) proforma for Clause 43, Item FC1								
Test Type	Conformance								
Test Status	Conditional Mandatory								
Requirement	Function specified in the state diagram shown in [5] Figure 43–3 and associated definitions in 43.2.3.1								
Test Purpose	Verify that the Operator MEN component with ENNI functionality collects frames from the ENNI to the EIs.								
Conditions	LAG = "Yes"								
Test Topology/OVC	 <table border="1" data-bbox="414 1030 893 1120"> <thead> <tr> <th>S-VID</th> <th>End Point ID</th> </tr> </thead> <tbody> <tr> <td>SVID34</td> <td>ENNI3_OVC13_End_Point_1</td> </tr> </tbody> </table> <table border="1" data-bbox="973 1030 1452 1120"> <thead> <tr> <th>CE-VID</th> <th>End Point ID</th> </tr> </thead> <tbody> <tr> <td>CVID10</td> <td>UNI1_OVC13_End_Point</td> </tr> </tbody> </table>	S-VID	End Point ID	SVID34	ENNI3_OVC13_End_Point_1	CE-VID	End Point ID	CVID10	UNI1_OVC13_End_Point
S-VID	End Point ID								
SVID34	ENNI3_OVC13_End_Point_1								
CE-VID	End Point ID								
CVID10	UNI1_OVC13_End_Point								
Test Procedure	Tester transmits a LACPDU (Request for enabling Collection/disabling Distribution) at each link of ENNI3 Tester transmits test frames Flow Definition1 (Default traffic flow definition) mapped to OVC13 at the link of ENNI3 configured as Active.								
Expected Results	All test frames are received at UNI1.								
Verdict	PASS, FAIL, or INCONCLUSIVE								

7.21 Marker protocol–Marker Responder (Collection)

ABSTRACT TEST CASES FOR ENNI PHASE 1									
Test Case ID	LA_OPERATION.MGR2.1								
Reference Document Source	IEEE Std 802.3 – 2005, Clause 43.2.6; Protocol implementation conformance statement (PICS) proforma for Clause 43, Item MGR2								
Test Type	Conformance								
Test Status	Conditional Mandatory								
Requirement	The Marker Responder receives Marker PDUs (generated by a Partner System’s Marker Generator), and transmits a Marker Response PDU through the same port from which the Marker PDU was received. While implementation of the Marker Generator/Receiver is optional, the ability to respond to a Marker PDU (the Marker Responder) is mandatory. An implementation conformant to this clause shall implement the Marker Responder as specified in 43.5.4.2, thus ensuring that implementation that need to make use of the protocol can do so.								
Test Purpose	Verify that the Operator MEN component with ENNI functionality, on receipt of a Marker PDU, sends a properly formatted Marker PDU specified in [5] Figure 43–18.								
Conditions	LAG = "Yes"								
Test Topology/OVC	<table border="1" style="width: 100%; margin-top: 10px;"> <tr> <td style="width: 50%;">S-VID</td> <td style="width: 50%;">End Point ID</td> </tr> <tr> <td>SVID34</td> <td>ENNI3_OVC13_End_Point_1</td> </tr> </table> <table border="1" style="width: 100%; margin-top: 10px;"> <tr> <td style="width: 50%;">CE-VID</td> <td style="width: 50%;">End Point ID</td> </tr> <tr> <td>CVID10</td> <td>UNI1_OVC13_End_Point</td> </tr> </table>	S-VID	End Point ID	SVID34	ENNI3_OVC13_End_Point_1	CE-VID	End Point ID	CVID10	UNI1_OVC13_End_Point
S-VID	End Point ID								
SVID34	ENNI3_OVC13_End_Point_1								
CE-VID	End Point ID								
CVID10	UNI1_OVC13_End_Point								
Test Procedure	Tester transmits a LACPDU (Request for enabling Collection/disabling Distribution) at each link of ENNI3 Tester transmits a Marker PDU at each link of ENNI3.								
Expected Results	Marker PDU is received at the link of ENNI3 configured as Active. Marker PDU is not received at the link of ENNI3 configured as Standby.								
Verdict	PASS, FAIL, or INCONCLUSIVE								

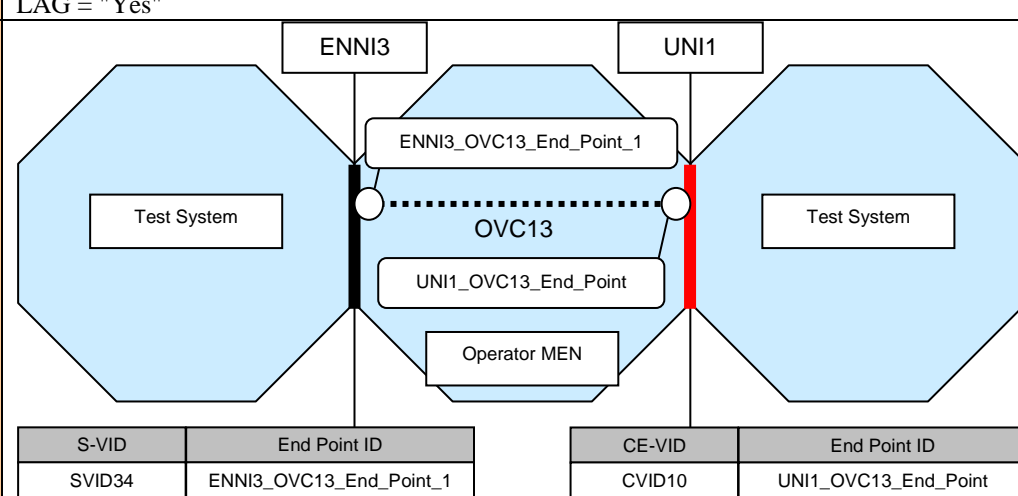

7.22 Port identification

ABSTRACT TEST CASES FOR ENNI PHASE 1									
Test Case ID	LA_OPERATION.PID1.1								
Reference Document Source	IEEE Std 802.3 – 2005, Clause 43.3.4 Protocol implementation conformance statement (PICS) proforma for Clause 43, Item PID1								
Test Type	Conformance								
Test Status	Conditional Mandatory								
Requirement	Link Aggregation Control uses a Port Identifier comprising the concatenation of a Port Priority and a Port Number, to identify the port. Port Numbers (and hence, Port Identifiers) shall be uniquely assigned within a System. Port Number 0 shall not be assigned to any port.								
Test Purpose	Verify that the Operator MEN component with ENNI functionality supports valid Port Priority and unique Port Number.								
Conditions	LAG = "Yes"								
Test Topology/OVC	 <table border="1" data-bbox="414 1064 877 1142"> <thead> <tr> <th>S-VID</th> <th>End Point ID</th> </tr> </thead> <tbody> <tr> <td>SVID34</td> <td>ENNI3_OVC13_End_Point_1</td> </tr> </tbody> </table> <table border="1" data-bbox="973 1064 1436 1142"> <thead> <tr> <th>CE-VID</th> <th>End Point ID</th> </tr> </thead> <tbody> <tr> <td>CVID10</td> <td>UNI1_OVC13_End_Point</td> </tr> </tbody> </table>	S-VID	End Point ID	SVID34	ENNI3_OVC13_End_Point_1	CE-VID	End Point ID	CVID10	UNI1_OVC13_End_Point
S-VID	End Point ID								
SVID34	ENNI3_OVC13_End_Point_1								
CE-VID	End Point ID								
CVID10	UNI1_OVC13_End_Point								
Test Procedure	Tester transmits a LACPDU (Request for informing current states) at each link of ENNI3.								
Expected Results	One LACPDU is received at each link of ENNI3: fields Actor_Port_Priority and Actor_Port are present, the value of Actor_Port is not equal 0, and the values of Actor_Port are different for LACPDU received at different links.								
Verdict	PASS, FAIL, or INCONCLUSIVE								

7.23 System Identification

ABSTRACT TEST CASES FOR ENNI PHASE 1									
Test Case ID	MANUEL_TC.SID1.1								
Reference Document Source	IEEE Std 802.3 – 2005, Clause 43.3.2, Protocol implementation conformance statement (PICS) proforma for Clause 43, Item SID1								
Test Type	Conformance								
Test Status	Conditional Mandatory								
Requirement	The globally unique identifier used to identify a System shall be the concatenation of a globally administered individual MAC address and the System Priority.								
Test Purpose	Verify that the Operator MEN component with ENNI functionality uses the globally administered individual MAC address and valid System Priority for exchanging LACPDU's.								
Conditions	LAG = "Yes"								
Test Topology/OVC	<table border="1" style="margin-top: 10px;"> <thead> <tr> <th>S-VID</th> <th>End Point ID</th> </tr> </thead> <tbody> <tr> <td>SVID34</td> <td>ENNI3_OVC13_End_Point_1</td> </tr> </tbody> </table> <table border="1" style="margin-top: 10px;"> <thead> <tr> <th>CE-VID</th> <th>End Point ID</th> </tr> </thead> <tbody> <tr> <td>CVID10</td> <td>UNI1_OVC13_End_Point</td> </tr> </tbody> </table>	S-VID	End Point ID	SVID34	ENNI3_OVC13_End_Point_1	CE-VID	End Point ID	CVID10	UNI1_OVC13_End_Point
S-VID	End Point ID								
SVID34	ENNI3_OVC13_End_Point_1								
CE-VID	End Point ID								
CVID10	UNI1_OVC13_End_Point								
Test Procedure	Tester transmits a LACPDU (Request for informing current states) at each link of ENNI3.								
Expected Results	One LACPDU is received at each link of ENNI3: fields Actor_System_Priority and Actor_System are present, the value of Actor_System is a globally unique MAC address.								
Verdict	PASS, FAIL, or INCONCLUSIVE								

7.24 Link Aggregation Group identification

ABSTRACT TEST CASES FOR ENNI PHASE 1									
Test Case ID	LA_OPERATION.LAG1.1								
Reference Document Source	IEEE Std 802.3 – 2005, Clause 43.3.6.1, Protocol implementation conformance statement (PICS) proforma for Clause 43, Item LAG1								
Test Type	Conformance								
Test Status	Conditional Mandatory								
Requirement	The local System’s values for the LAG ID values shall be non-zero								
Test Purpose	Verify that the local System’s values for the LAG ID values shall be non-zero.								
Conditions	LAG = "Yes"								
Test Topology/OVC	<p>The diagram illustrates a network topology for testing Link Aggregation Group (LAG) identification. Two Test Systems are connected to a central OVC13 (Operator MEN) via ENNI3 and UNI1. The OVC13 is connected to ENNI3 and UNI1 through ENNI3_OVC13_End_Point_1 and UNI1_OVC13_End_Point respectively. Below the diagram are two tables:</p> <table border="1" style="display: inline-table; margin-right: 20px;"> <thead> <tr> <th>S-VID</th> <th>End Point ID</th> </tr> </thead> <tbody> <tr> <td>SVID34</td> <td>ENNI3_OVC13_End_Point_1</td> </tr> </tbody> </table> <table border="1" style="display: inline-table;"> <thead> <tr> <th>CE-VID</th> <th>End Point ID</th> </tr> </thead> <tbody> <tr> <td>CVID10</td> <td>UNI1_OVC13_End_Point</td> </tr> </tbody> </table>	S-VID	End Point ID	SVID34	ENNI3_OVC13_End_Point_1	CE-VID	End Point ID	CVID10	UNI1_OVC13_End_Point
S-VID	End Point ID								
SVID34	ENNI3_OVC13_End_Point_1								
CE-VID	End Point ID								
CVID10	UNI1_OVC13_End_Point								
Test Procedure	Tester transmits a LACPDU (Request for informing current states) at each link of ENNI3: Partner_Key is set to 0.								
Expected Results	LACPDU is received at each link of ENNI3: fields Actor_System, Actor_System_Priority, Actor_Port, Actor_Port_Priority and Actor_Key are present, values of Actor_System, Actor_System_Priority, Actor_Port, Actor_Port_Priority and Actor_Key are not equal 0.								
Verdict	PASS, FAIL, or INCONCLUSIVE								

7.25 Reallocation conversation (Distribution)

ABSTRACT TEST CASES FOR ENNI PHASE 1									
Test Case ID	LA_OPERATION.DLA1.1								
Reference Document Source	IEEE Std 802.3 – 2005, Clause 43.3.13; Protocol implementation conformance statement (PICS) proforma for Clause 43, Item DLA1								
Test Type	Conformance								
Test Status	Conditional Mandatory								
Requirement	Any conversation that is reallocated to a different link as result of detaching a link from an Aggregator shall have its frame ordering preserved.								
Test Purpose	Verify that the Operator MEN component with ENNI functionality preserves frame ordering when a conversation is reallocated to a different link as result of detaching a link from an Aggregator.								
Conditions	LAG = "Yes"								
Test Topology/OVC	<table border="1" style="margin-top: 10px;"> <thead> <tr> <th>S-VID</th> <th>End Point ID</th> </tr> </thead> <tbody> <tr> <td>SVID34</td> <td>ENNI3_OVC13_End_Point_1</td> </tr> </tbody> </table> <table border="1" style="margin-top: 10px;"> <thead> <tr> <th>CE-VID</th> <th>End Point ID</th> </tr> </thead> <tbody> <tr> <td>CVID10</td> <td>UNI1_OVC13_End_Point</td> </tr> </tbody> </table>	S-VID	End Point ID	SVID34	ENNI3_OVC13_End_Point_1	CE-VID	End Point ID	CVID10	UNI1_OVC13_End_Point
S-VID	End Point ID								
SVID34	ENNI3_OVC13_End_Point_1								
CE-VID	End Point ID								
CVID10	UNI1_OVC13_End_Point								
Test Procedure	Tester transmits test frames Flow Definition1 (Default traffic flow definition) mapped to OVC13 <b>Error! Reference source not found.</b> at UNI1 Tester transmits a LACPDU (Request for detaching) at the link of ENNI3 configured as Active.								
Expected Results	Test frames are received at ENNI3: order of the frames is unchanged.								
Verdict	PASS, FAIL, or INCONCLUSIVE								

7.26 RM–Entering CURRENT state after Initialization

ABSTRACT TEST CASES FOR ENNI PHASE 1									
Test Case ID	LACP_STATE_TRANSITIONS.RM1.1								
Reference Document Source	IEEE Std 802.3 – 2005, Clause 43.4.12, Protocol implementation conformance statement (PICS) proforma for Clause 43, Item RM1								
Test Type	Conformance								
Test Status	Conditional Mandatory								
Requirement	Receive machine as defined in Figure 43–10 and associated parameters								
Test Purpose	Verify that the Operator MEN component with ENNI functionality, after a successful initialization, on receipt of a LACPDU, enters CURRENT state.								
Conditions	LAG = "Yes"								
Test Topology/OVC	<table border="1" style="width: 100%; margin-top: 10px;"> <tr> <td style="width: 50%; text-align: center;">S-VID</td> <td style="width: 50%; text-align: center;">End Point ID</td> </tr> <tr> <td style="text-align: center;">SVID34</td> <td style="text-align: center;">ENNI3_OVC13_End_Point_1</td> </tr> </table> <table border="1" style="width: 100%; margin-top: 10px;"> <tr> <td style="width: 50%; text-align: center;">CE-VID</td> <td style="width: 50%; text-align: center;">End Point ID</td> </tr> <tr> <td style="text-align: center;">CVID10</td> <td style="text-align: center;">UNI1_OVC13_End_Point</td> </tr> </table>	S-VID	End Point ID	SVID34	ENNI3_OVC13_End_Point_1	CE-VID	End Point ID	CVID10	UNI1_OVC13_End_Point
S-VID	End Point ID								
SVID34	ENNI3_OVC13_End_Point_1								
CE-VID	End Point ID								
CVID10	UNI1_OVC13_End_Point								
Test Procedure	Reboot the Operator MEN component with the ENNI functionality. Tester transmits a LACPDU (Request for informing current states) at each link at ENNI3 after Reboot time								
Expected Results	A LACPDU is received at each link at ENNI3.								
Verdict	PASS, FAIL, or INCONCLUSIVE								

7.27 RM-Entering CURRENT state after port up

ABSTRACT TEST CASES FOR ENNI PHASE 1									
Test Case ID	LACP_STATE_TRANSITIONS.RM1.2								
Reference Document Source	IEEE Std 802.3 – 2005, Clause 43.4.12, Protocol implementation conformance statement (PICS) proforma for Clause 43, Item RM1								
Test Type	Conformance								
Test Status	Conditional Mandatory								
Requirement	Receive machine as defined in Figure 43–10 and associated parameters								
Test Purpose	Verify that the Operator MEN component with ENNI functionality, after a port becoming up, on receipt of a LACPDU, enters CURRENT state.								
Conditions	LAG = "Yes"								
Test Topology/OVC	<table border="1" style="margin-top: 10px;"> <thead> <tr> <th>S-VID</th> <th>End Point ID</th> </tr> </thead> <tbody> <tr> <td>SVID34</td> <td>ENNI3_OVC13_End_Point_1</td> </tr> </tbody> </table> <table border="1" style="margin-top: 10px;"> <thead> <tr> <th>CE-VID</th> <th>End Point ID</th> </tr> </thead> <tbody> <tr> <td>CVID10</td> <td>UNI1_OVC13_End_Point</td> </tr> </tbody> </table>	S-VID	End Point ID	SVID34	ENNI3_OVC13_End_Point_1	CE-VID	End Point ID	CVID10	UNI1_OVC13_End_Point
S-VID	End Point ID								
SVID34	ENNI3_OVC13_End_Point_1								
CE-VID	End Point ID								
CVID10	UNI1_OVC13_End_Point								
Test Procedure	Shut down tester port facing ENNI Bring up tester port facing ENNI Tester transmits a LACPDU (Request for informing current states) at each link of ENNI3.								
Expected Results	A LACPDU is received at the link connected to the port that was shut down in the test procedure.								
Verdict	PASS, FAIL, or INCONCLUSIVE								

7.28 RM-Entering CURRENT state from CURRENT State

ABSTRACT TEST CASES FOR ENNI PHASE 1									
Test Case ID	LACP_STATE_TRANSITIONS.RM1.3								
Reference Document Source	IEEE Std 802.3 – 2005, Clause 43.4.12, Protocol implementation conformance statement (PICS) proforma for Clause 43, Item RM1								
Test Type	Conformance								
Test Status	Conditional Mandatory								
Requirement	Receive machine as defined in Figure 43–10 and associated parameters								
Test Purpose	Verify that the Operator MEN component with ENNI functionality, after entering CURRENT state, on receipt of a LACPDU, enters CURRENT state again.								
Conditions	LAG = "Yes"								
Test Topology/OVC	<p>The diagram illustrates a network topology for testing. Two Test Systems are connected to an OVC13. The left Test System is connected to ENNI3, which is associated with SVID34 and End Point ID ENNI3_OVC13_End_Point_1. The right Test System is connected to UNI1, which is associated with CVID10 and End Point ID UNI1_OVC13_End_Point. An Operator MEN component is connected to the OVC13. A dashed line represents the OVC13 connection between the two Test Systems.</p> <table border="1" style="width: 100%; border-collapse: collapse;"> <thead> <tr> <th style="width: 50%;">S-VID</th> <th style="width: 50%;">End Point ID</th> <th style="width: 50%;">CE-VID</th> <th style="width: 50%;">End Point ID</th> </tr> </thead> <tbody> <tr> <td>SVID34</td> <td>ENNI3_OVC13_End_Point_1</td> <td>CVID10</td> <td>UNI1_OVC13_End_Point</td> </tr> </tbody> </table>	S-VID	End Point ID	CE-VID	End Point ID	SVID34	ENNI3_OVC13_End_Point_1	CVID10	UNI1_OVC13_End_Point
S-VID	End Point ID	CE-VID	End Point ID						
SVID34	ENNI3_OVC13_End_Point_1	CVID10	UNI1_OVC13_End_Point						
Test Procedure	Tester transmits a LACPDU (Default Configuration) at each link of ENNI3 Tester transmits a LACPDU (Request for informing current states) at each link of ENNI3								
Expected Results	A LACPDU is received at each link of ENNI3: field Actor_State.Expired is set to FALSE.								
Verdict	PASS, FAIL, or INCONCLUSIVE								

7.29 PM–No Periodic LACPDU when both LACP\_Activity are passive

ABSTRACT TEST CASES FOR ENNI PHASE 1									
Test Case ID	LACP_STATE_TRANSITIONS.PM1.1								
Reference Document Source	IEEE Std 802.3 – 2005, Clause 43.4.13, Protocol implementation conformance statement (PICS) proforma for Clause 43, Item PM1								
Test Type	Conformance								
Test Status	Conditional Mandatory								
Requirement	Periodic Transmission machine as defined in Figure 43–11 and associated parameters								
Test Purpose	Verify that the Operator MEN component with ENNI functionality, when LACP_Activity of Actor and Partner both are PASSIVE, doesn't send any LACPDUs periodically.								
Conditions	LAG = "Yes"								
Test Topology/OVC	<table border="1" style="width: 100%; margin-top: 10px;"> <tr> <td style="width: 50%; text-align: center;">S-VID</td> <td style="width: 50%; text-align: center;">End Point ID</td> </tr> <tr> <td style="text-align: center;">SVID34</td> <td style="text-align: center;">ENNI3_OVC13_End_Point_1</td> </tr> </table> <table border="1" style="width: 100%; margin-top: 10px;"> <tr> <td style="width: 50%; text-align: center;">CE-VID</td> <td style="width: 50%; text-align: center;">End Point ID</td> </tr> <tr> <td style="text-align: center;">CVID10</td> <td style="text-align: center;">UNI1_OVC13_End_Point</td> </tr> </table>	S-VID	End Point ID	SVID34	ENNI3_OVC13_End_Point_1	CE-VID	End Point ID	CVID10	UNI1_OVC13_End_Point
S-VID	End Point ID								
SVID34	ENNI3_OVC13_End_Point_1								
CE-VID	End Point ID								
CVID10	UNI1_OVC13_End_Point								
Test Procedure	Configure the Operator MEN component with ENNI functionality: set Actor_Admin_Port_State.LACP_Activity to FALSE. Tester listens for up to (LACPDU listen time + 2 x Slow_Periodic_Time) seconds at ENNI3.								
Expected Results	LACPDUs are not received at ENNI3.								
Verdict	PASS, FAIL, or INCONCLUSIVE								



7.30 PM-Periodic LACPDU during initialization

ABSTRACT TEST CASES FOR ENNI PHASE 1									
Test Case ID	LACP_STATE_TRANSITIONS.PM1.3								
Reference Document Source	IEEE Std 802.3 – 2005, Clause 43.4.13, Protocol implementation conformance statement (PICS) proforma for Clause 43, Item PM1								
Test Type	Conformance								
Test Status	Conditional Mandatory								
Requirement	Periodic Transmission machine as defined in Figure 43–11 and associated parameters								
Test Purpose	Verify that the Operator MEN component with ENNI functionality, during initialization, doesn't send any LACPDUs periodically.								
Conditions	LAG = "Yes"								
Test Topology/OVC	<p>The diagram illustrates a network topology for testing. Two Test Systems are connected to an OVC13 (Operator Managed Virtual Circuit) through ENNI3 and UNI1. The OVC13 contains two end points: ENNI3_OVC13_End_Point_1 and UNI1_OVC13_End_Point. An Operator MEN component is also connected to the OVC13. Below the diagram, two tables provide configuration details:</p> <table border="1" style="display: inline-table; margin-right: 20px;"> <thead> <tr> <th>S-VID</th> <th>End Point ID</th> </tr> </thead> <tbody> <tr> <td>SVID34</td> <td>ENNI3_OVC13_End_Point_1</td> </tr> </tbody> </table> <table border="1" style="display: inline-table;"> <thead> <tr> <th>CE-VID</th> <th>End Point ID</th> </tr> </thead> <tbody> <tr> <td>CVID10</td> <td>UNI1_OVC13_End_Point</td> </tr> </tbody> </table>	S-VID	End Point ID	SVID34	ENNI3_OVC13_End_Point_1	CE-VID	End Point ID	CVID10	UNI1_OVC13_End_Point
S-VID	End Point ID								
SVID34	ENNI3_OVC13_End_Point_1								
CE-VID	End Point ID								
CVID10	UNI1_OVC13_End_Point								
Test Procedure	Reboot the Operator MEN component with ENNI functionality Tester listens for up to Reboot time at ENNI3								
Expected Results	LACPDUs are not received at ENNI3.								
Verdict	PASS, FAIL, or INCONCLUSIVE								

7.31 MUX-Entering DETACHED state

ABSTRACT TEST CASES FOR ENNI PHASE 1									
Test Case ID	LACP_FUNCTIONALITY.XM1.1								
Reference Document Source	IEEE Std 802.3 – 2005, Clause 43.4.15, Protocol implementation conformance statement (PICS) proforma for Clause 43, Item XM1								
Test Type	Conformance								
Test Status	Conditional Mandatory								
Requirement	MUX machine as defined in Figure 43–13 and associated parameters								
Test Purpose	Verify that the Operator MEN component with ENNI functionality, on receipt of a LACPDU requesting for detaching, enters DETACHED state.								
Conditions	LAG = "Yes"								
Test Topology/OVC	<table border="1" style="width: 100%; margin-top: 10px;"> <tr> <td style="width: 50%; text-align: center;">S-VID</td> <td style="width: 50%; text-align: center;">End Point ID</td> <td style="width: 50%; text-align: center;">CE-VID</td> <td style="width: 50%; text-align: center;">End Point ID</td> </tr> <tr> <td style="text-align: center;">SVID34</td> <td style="text-align: center;">ENNI3_OVC13_End_Point_1</td> <td style="text-align: center;">CVID10</td> <td style="text-align: center;">UNI1_OVC13_End_Point</td> </tr> </table>	S-VID	End Point ID	CE-VID	End Point ID	SVID34	ENNI3_OVC13_End_Point_1	CVID10	UNI1_OVC13_End_Point
S-VID	End Point ID	CE-VID	End Point ID						
SVID34	ENNI3_OVC13_End_Point_1	CVID10	UNI1_OVC13_End_Point						
Test Procedure	Tester transmits a LACPDU (Request for detaching) at the link of ENNI3 configured as Active.								
Expected Results	LACPDU are received at the link of ENNI3 configured as Active: field Actor_State.Synchronization is set to FALSE, field Actor_State.Collecting is set to FALSE, field Actor_State.Distributing is set to FALSE.								
Verdict	PASS, FAIL, or INCONCLUSIVE								

7.32 MUX–Entering ATTACHED state

ABSTRACT TEST CASES FOR ENNI PHASE 1									
Test Case ID	LACP_FUNCTIONALITY.XM1.2								
Reference Document Source	IEEE Std 802.3 – 2005, Clause 43.4.15, Protocol implementation conformance statement (PICS) proforma for Clause 43, Item XM1								
Test Type	Conformance								
Test Status	Conditional Mandatory								
Requirement	MUX machine as defined in Figure 43–13 and associated parameters								
Test Purpose	Verify that the Operator MEN component with ENNI functionality, according to the configuration, enters ATTACHED state.								
Conditions	LAG = "Yes"								
Test Topology/OVC	<table border="1" style="width: 100%; margin-top: 10px;"> <tr> <td style="width: 50%;">S-VID</td> <td style="width: 50%;">End Point ID</td> <td style="width: 50%;">CE-VID</td> <td style="width: 50%;">End Point ID</td> </tr> <tr> <td>SVID34</td> <td>ENNI3_OVC13_End_Point_1</td> <td>CVID10</td> <td>UNI1_OVC13_End_Point</td> </tr> </table>	S-VID	End Point ID	CE-VID	End Point ID	SVID34	ENNI3_OVC13_End_Point_1	CVID10	UNI1_OVC13_End_Point
S-VID	End Point ID	CE-VID	End Point ID						
SVID34	ENNI3_OVC13_End_Point_1	CVID10	UNI1_OVC13_End_Point						
Test Procedure	Tester transmits a LACPDU (Request for informing current states) at each link of ENNI3								
Expected Results	LACPDU is received at the link of ENNI3 configured as Active: field Actor_State.Synchronization is set to TRUE LACPDU is received at the link of ENNI3 configured as Standby: field Actor_State.Synchronization is set to FALSE								
Verdict	PASS, FAIL, or INCONCLUSIVE								

7.33 MUX-Entering COLLECTING state

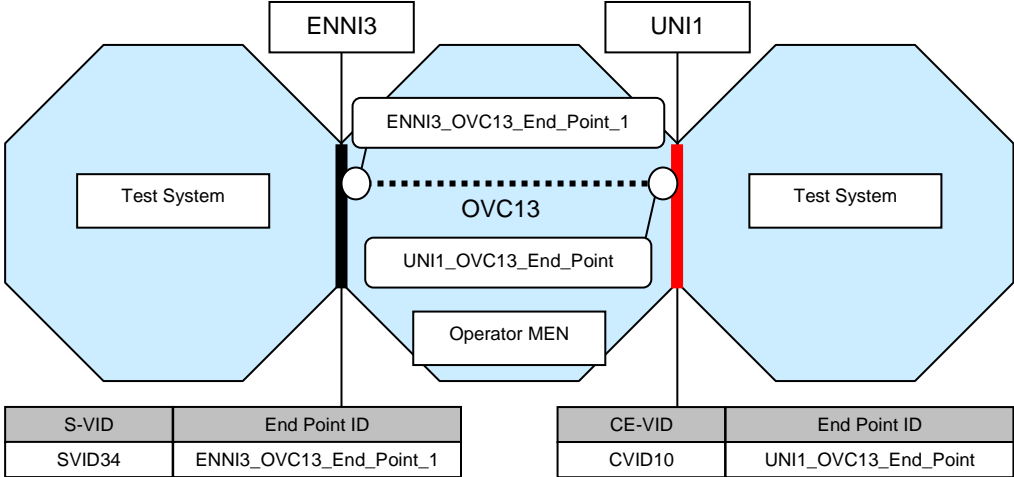
ABSTRACT TEST CASES FOR ENNI PHASE 1									
Test Case ID	LACP_FUNCTIONALITY.XM1.3								
Reference Document Source	IEEE Std 802.3 – 2005, Clause 43.4.15, Protocol implementation conformance statement (PICS) proforma for Clause 43, Item XM1								
Test Type	Conformance								
Test Status	Conditional Mandatory								
Requirement	MUX machine as defined in Figure 43–13 and associated parameters								
Test Purpose	Verify that the Operator MEN component with ENNI functionality, on receipt of a LACPDU requesting for collection, enters the COLLECTING state.								
Conditions	LAG = "Yes"								
Test Topology/OVC	 <table border="1" data-bbox="427 1032 890 1104"> <thead> <tr> <th>S-VID</th> <th>End Point ID</th> </tr> </thead> <tbody> <tr> <td>SVID34</td> <td>ENNI3_OVC13_End_Point_1</td> </tr> </tbody> </table> <table border="1" data-bbox="986 1032 1445 1104"> <thead> <tr> <th>CE-VID</th> <th>End Point ID</th> </tr> </thead> <tbody> <tr> <td>CVID10</td> <td>UNI1_OVC13_End_Point</td> </tr> </tbody> </table>	S-VID	End Point ID	SVID34	ENNI3_OVC13_End_Point_1	CE-VID	End Point ID	CVID10	UNI1_OVC13_End_Point
S-VID	End Point ID								
SVID34	ENNI3_OVC13_End_Point_1								
CE-VID	End Point ID								
CVID10	UNI1_OVC13_End_Point								
Test Procedure	Tester transmits a LACPDU (Request for enabling Collection/disabling Distribution) at each link of ENNI3								
Expected Results	LACPDU's are received at the link of ENNI3 configured as Active: field Actor_State.Synchronization is set to TRUE, field Actor_State.Collecting is set to TRUE, Actor_State.Distributing is set to FALSE. LACPDU's are received at the link of ENNI3 configured as Standby: field Actor_State.Synchronization is set to FALSE, field Actor_State.Collecting is set to FALSE, Actor_State.Distributing is set to FALSE.								
Verdict	PASS, FAIL, or INCONCLUSIVE								

7.34 MUX-Entering DISTRIBUTING state

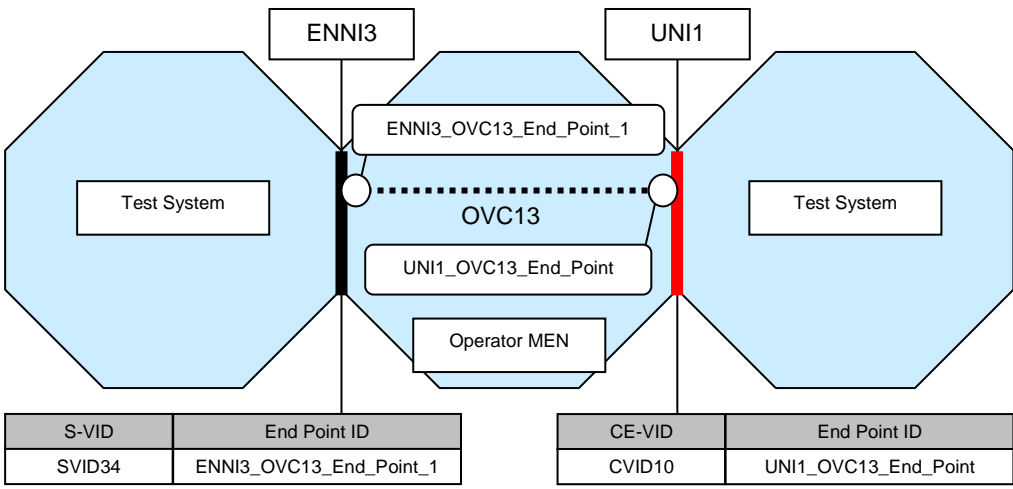
ABSTRACT TEST CASES FOR ENNI PHASE 1									
Test Case ID	LACP_FUNCTIONALITY.XM1.4								
Reference Document Source	IEEE Std 802.3 – 2005, Clause 43.4.15, Protocol implementation conformance statement (PICS) proforma for Clause 43, Item XM1								
Test Type	Conformance								
Test Status	Conditional Mandatory								
Requirement	MUX machine as defined in Figure 43–13 and associated parameters								
Test Purpose	Verify that the Operator MEN component with ENNI functionality, on receipt of a LACPDU requesting for distribution, enters the DISTRIBUTING state.								
Conditions	LAG = "Yes"								
Test Topology/OVC	 <table border="1" data-bbox="427 1030 890 1108"> <thead> <tr> <th>S-VID</th> <th>End Point ID</th> </tr> </thead> <tbody> <tr> <td>SVID34</td> <td>ENNI3_OVC13_End_Point_1</td> </tr> </tbody> </table> <table border="1" data-bbox="981 1030 1444 1108"> <thead> <tr> <th>CE-VID</th> <th>End Point ID</th> </tr> </thead> <tbody> <tr> <td>CVID10</td> <td>UNI1_OVC13_End_Point</td> </tr> </tbody> </table>	S-VID	End Point ID	SVID34	ENNI3_OVC13_End_Point_1	CE-VID	End Point ID	CVID10	UNI1_OVC13_End_Point
S-VID	End Point ID								
SVID34	ENNI3_OVC13_End_Point_1								
CE-VID	End Point ID								
CVID10	UNI1_OVC13_End_Point								
Test Procedure	Tester transmits a LACPDU (Request for enabling Distribution) at each link of ENNI3								
Expected Results	LACPDU's are received at the link of ENNI3 configured as Active: field Actor_State.Synchronization is set to TRUE, field Actor_State.Collecting is set to TRUE, Actor_State.Distributing is set to TRUE. LACPDU's are received at the link of ENNI3 configured as Standby: field Actor_State.Synchronization is set to FALSE, field Actor_State.Collecting is set to FALSE, Actor_State.Distributing is set to FALSE.								
Verdict	PASS, FAIL, or INCONCLUSIVE								

7.35 TM–No Transmission when No Periodic LACPDU

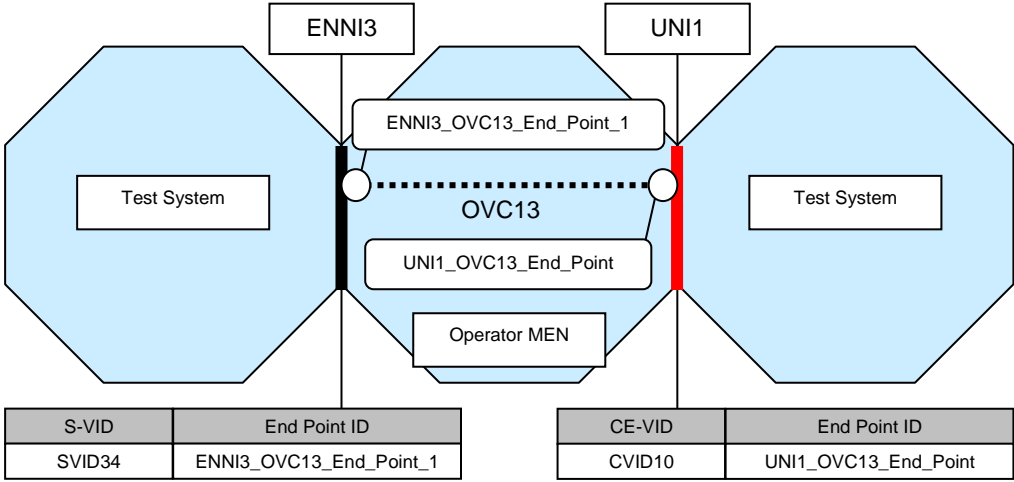
ABSTRACT TEST CASES FOR ENNI PHASE 1									
Test Case ID	LACP_STATE_TRANSITIONS.TM10.1								
Reference Document Source	IEEE Std 802.3 – 2005, Clause 43.4.25, Protocol implementation conformance statement (PICS) proforma for Clause 43, Item TM10								
Test Type	Conformance								
Test Status	Conditional Mandatory								
Requirement	The Transmission machine shall set NTT to FALSE and doesn't transmit when Periodic machine is in the NO_PERIODIC state.								
Test Purpose	Verify that the Operator MEN component with ENNI functionality, when Periodic machine is in the NO_PERIODIC state, doesn't send LACPDU.								
Conditions	LAG = "Yes"								
Test Topology/OVC	 <table border="1" data-bbox="427 1064 890 1137"> <thead> <tr> <th>S-VID</th> <th>End Point ID</th> </tr> </thead> <tbody> <tr> <td>SVID34</td> <td>ENNI3_OVC13_End_Point_1</td> </tr> </tbody> </table> <table border="1" data-bbox="986 1064 1445 1137"> <thead> <tr> <th>CE-VID</th> <th>End Point ID</th> </tr> </thead> <tbody> <tr> <td>CVID10</td> <td>UNI1_OVC13_End_Point</td> </tr> </tbody> </table>	S-VID	End Point ID	SVID34	ENNI3_OVC13_End_Point_1	CE-VID	End Point ID	CVID10	UNI1_OVC13_End_Point
S-VID	End Point ID								
SVID34	ENNI3_OVC13_End_Point_1								
CE-VID	End Point ID								
CVID10	UNI1_OVC13_End_Point								
Test Procedure	Configure the Operator MEN component with ENNI functionality: set Actor_Admin_Port_State.LACP_Activity to FALSE Tester transmits a LACPDU (Request for informing current states) at each link of ENNI3 Tester listens for up to (LACPDU listen time + LACP process time) seconds at ENNI3								
Expected Results	LACPDU are not received at ENNI3.								
Verdict	PASS, FAIL, or INCONCLUSIVE								

7.36 RM-Update Partner's view

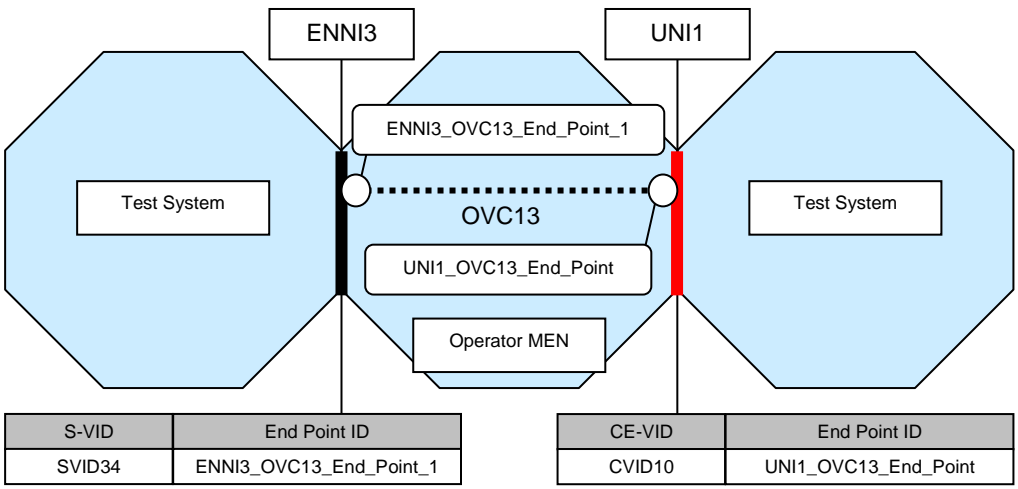
ABSTRACT TEST CASES FOR ENNI PHASE 1									
Test Case ID	LACP_FUNCTIONALITY.RM1.1								
Reference Document Source	IEEE Std 802.3 – 2005, Clause 43.4.12, Protocol implementation conformance statement (PICS) proforma for Clause 43, Item RM1								
Test Type	Conformance								
Test Status	Conditional Mandatory								
Requirement	Receive machine as defined in Figure 43–10 and associated parameters								
Test Purpose	Verify that the Operator MEN component with ENNI functionality, on receipt of a LACPDU carrying not up-to-date LACP_Activity information about ENNI, sends a LACPDU.								
Conditions	LAG = "Yes"								
Test Topology/OVC	 <table border="1" data-bbox="427 1030 890 1108"> <thead> <tr> <th>S-VID</th> <th>End Point ID</th> </tr> </thead> <tbody> <tr> <td>SVID34</td> <td>ENNI3_OVC13_End_Point_1</td> </tr> </tbody> </table> <table border="1" data-bbox="986 1030 1449 1108"> <thead> <tr> <th>CE-VID</th> <th>End Point ID</th> </tr> </thead> <tbody> <tr> <td>CVID10</td> <td>UNI1_OVC13_End_Point</td> </tr> </tbody> </table>	S-VID	End Point ID	SVID34	ENNI3_OVC13_End_Point_1	CE-VID	End Point ID	CVID10	UNI1_OVC13_End_Point
S-VID	End Point ID								
SVID34	ENNI3_OVC13_End_Point_1								
CE-VID	End Point ID								
CVID10	UNI1_OVC13_End_Point								
Test Procedure	Tester transmits a LACPDU (Request for informing current states) at each link of ENNI3								
Expected Results	A LACPDU is received at each link of ENNI3.								
Verdict	PASS, FAIL, or INCONCLUSIVE								

7.37 RM–Unselected in DEFAULTED state

ABSTRACT TEST CASES FOR ENNI PHASE 1									
Test Case ID	LACP_FUNCTIONALITY.RM1.4								
Reference Document Source	IEEE Std 802.3 – 2005, Clause 43.4.12, Protocol implementation conformance statement (PICS) proforma for Clause 43, Item RM1								
Test Type	Conditional Mandatory								
Test Status	Mandatory								
Requirement	Receive machine as defined in Figure 43–10 and associated parameters								
Test Purpose	Verify that the Operator MEN component with ENNI functionality detaches links from the LAG. Before enters DEFAULTED state, the Operator MEN component with ENNI functionality should, on receipt of a LACPDU with a different LAG ID, changes its partner Key with received LAG ID. After enters the DEFAULTED state, the Operator MEN component with ENNI functionality changes its partner Key with default configured LAG ID.								
Conditions	LAG = "Yes"								
Test Topology/OVC	<table border="1" style="margin-top: 10px;"> <thead> <tr> <th>S-VID</th> <th>End Point ID</th> <th>CE-VID</th> <th>End Point ID</th> </tr> </thead> <tbody> <tr> <td>SVID34</td> <td>ENNI3_OVC13_End_Point_1</td> <td>CVID10</td> <td>UNI1_OVC13_End_Point</td> </tr> </tbody> </table>	S-VID	End Point ID	CE-VID	End Point ID	SVID34	ENNI3_OVC13_End_Point_1	CVID10	UNI1_OVC13_End_Point
S-VID	End Point ID	CE-VID	End Point ID						
SVID34	ENNI3_OVC13_End_Point_1	CVID10	UNI1_OVC13_End_Point						
Test Procedure	Tester transmits a LACPDU (Request for detaching) at the link of ENNI3 configured as Active. Tester listens for up to (3 x LACPDU listen time + 3 x LACP process time + Short_Timeout_Time + Long_Timeout_Time) seconds at ENNI3.								
Expected Results	LACPDU is received at the link of ENNI3 configured as Active: field Actor_State.Synchronization is set to FALSE, field Partner_Key is set to Actor_Admin_Aggregationor_Key + 1 LACPDU is received at the link of ENNI3 configured as Standby: field Actor_State.Synchronization is set to FALSE, field Partner_Key is set to Actor_Admin_Aggregationor_Key								
Verdict	PASS, FAIL, or INCONCLUSIVE								

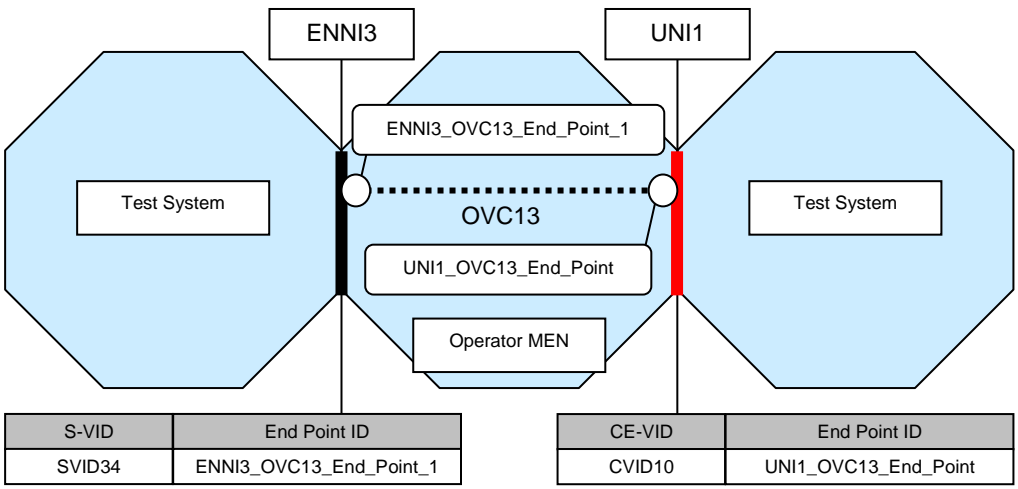

7.38 RM-Unselected in CURRENT state

ABSTRACT TEST CASES FOR ENNI PHASE 1									
Test Case ID	LACP_FUNCTIONALITY.RM1.6								
Reference Document Source	IEEE Std 802.3 – 2005, Clause 43.4.12, Protocol implementation conformance statement (PICS) proforma for Clause 43, Item RM1								
Test Type	Conformance								
Test Status	Conditional Mandatory								
Requirement	Receive machine as defined in Figure 43–10 and associated parameters								
Test Purpose	Verify that the Operator MEN component with ENNI functionality, on receipt of a LACPDU with a different LAG ID, enters the CURRENT state and detaches the link from the LAG.								
Conditions	LAG = "Yes"								
Test Topology/OVC	 <table border="1" data-bbox="427 1034 890 1108"> <thead> <tr> <th>S-VID</th> <th>End Point ID</th> </tr> </thead> <tbody> <tr> <td>SVID34</td> <td>ENNI3_OVC13_End_Point_1</td> </tr> </tbody> </table> <table border="1" data-bbox="986 1034 1449 1108"> <thead> <tr> <th>CE-VID</th> <th>End Point ID</th> </tr> </thead> <tbody> <tr> <td>CVID10</td> <td>UNI1_OVC13_End_Point</td> </tr> </tbody> </table>	S-VID	End Point ID	SVID34	ENNI3_OVC13_End_Point_1	CE-VID	End Point ID	CVID10	UNI1_OVC13_End_Point
S-VID	End Point ID								
SVID34	ENNI3_OVC13_End_Point_1								
CE-VID	End Point ID								
CVID10	UNI1_OVC13_End_Point								
Test Procedure	Tester transmits a LACPDU (Request for detaching) at the link of ENNI3 configured as Active.								
Expected Results	LACPDU is received at the link of ENNI3 configured as Active: field Actor_State.Synchronization is set to FALSE, field Partner_Key is set to Actor_Admin_Aggregationor_Key + 1								
Verdict	PASS, FAIL, or INCONCLUSIVE								

7.39 RM–Selected in CURRENT state

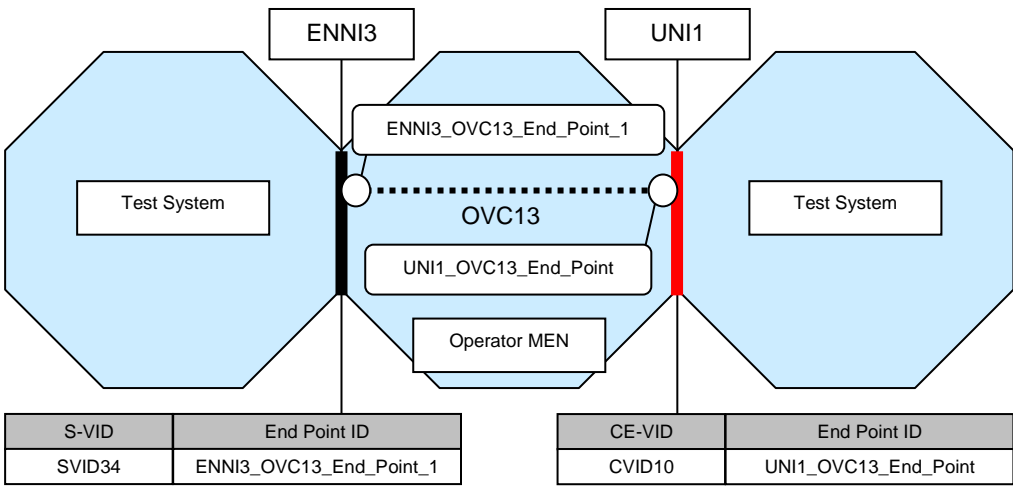
ABSTRACT TEST CASES FOR ENNI PHASE 1									
Test Case ID	LACP_FUNCTIONALITY.RM1.7								
Reference Document Source	IEEE Std 802.3 – 2005, Clause 43.4.12, Protocol implementation conformance statement (PICS) proforma for Clause 43, Item RM1								
Test Type	Conformance								
Test Status	Conditional Mandatory								
Requirement	Receive machine as defined in Figure 43–10 and associated parameters								
Test Purpose	Verify that the Operator MEN component with ENNI functionality, on receipt of a LACPDU with no changes on LAG ID, remains the link to be attached to the LAG.								
Conditions	LAG = "Yes"								
Test Topology/OVC	 <table border="1" data-bbox="427 1030 890 1108"> <thead> <tr> <th>S-VID</th> <th>End Point ID</th> </tr> </thead> <tbody> <tr> <td>SVID34</td> <td>ENNI3_OVC13_End_Point_1</td> </tr> </tbody> </table> <table border="1" data-bbox="986 1030 1444 1108"> <thead> <tr> <th>CE-VID</th> <th>End Point ID</th> </tr> </thead> <tbody> <tr> <td>CVID10</td> <td>UNI1_OVC13_End_Point</td> </tr> </tbody> </table>	S-VID	End Point ID	SVID34	ENNI3_OVC13_End_Point_1	CE-VID	End Point ID	CVID10	UNI1_OVC13_End_Point
S-VID	End Point ID								
SVID34	ENNI3_OVC13_End_Point_1								
CE-VID	End Point ID								
CVID10	UNI1_OVC13_End_Point								
Test Procedure	<p>Tester transmits a LACPDU (Default Configuration) at the link of ENNI3 configured as Active.</p> <p>Tester transmits a LACPDU (Request for informing current states) at the link of ENNI3 configured as Active.</p>								
Expected Results	LACPDU is received at the link of ENNI3 configured as Active: field Actor_State.Synchronization is set to TRUE.								
Verdict	PASS, FAIL, or INCONCLUSIVE								

7.40 RM–Not validated fields

ABSTRACT TEST CASES FOR ENNI PHASE 1									
Test Case ID	LACP_STATE_TRANSITIONS.RM1.11								
Reference Document Source	IEEE Std 802.3 – 2005, Clause 43.4.12, Protocol implementation conformance statement (PICS) proforma for Clause 43, Item RM1								
Test Type	Conformance								
Test Status	Conditional Mandatory								
Requirement	In the process of executing the recordPDU function, a Receive machine compliant to this standard shall not validate the Version Number, TLV_type, or Reserved fields in received LACPDU. The same actions are taken regardless of the values received in these fields.								
Test Purpose	Verify that the Operator MEN component with ENNI functionality, In the process of executing the recordPDU function, doesn't validate the Version Number, TLV_type, or Reserved fields in received LACPDU. The same actions are taken regardless of the values received in these fields.								
Conditions	LAG = "Yes"								
Test Topology/OVC	<table border="1" style="margin-top: 10px;"> <thead> <tr> <th>S-VID</th> <th>End Point ID</th> </tr> </thead> <tbody> <tr> <td>SVID34</td> <td>ENNI3_OVC13_End_Point_1</td> </tr> </tbody> </table> <table border="1" style="margin-top: 10px;"> <thead> <tr> <th>CE-VID</th> <th>End Point ID</th> </tr> </thead> <tbody> <tr> <td>CVID10</td> <td>UNI1_OVC13_End_Point</td> </tr> </tbody> </table>	S-VID	End Point ID	SVID34	ENNI3_OVC13_End_Point_1	CE-VID	End Point ID	CVID10	UNI1_OVC13_End_Point
S-VID	End Point ID								
SVID34	ENNI3_OVC13_End_Point_1								
CE-VID	End Point ID								
CVID10	UNI1_OVC13_End_Point								
Test Procedure	Tester transmits a LACPDU (Default Configuration) at each link of ENNI3: all reserved fields are set to 1, field Version Number is set to 2, all TLV_type fields are set to 1.								
Expected Results	A LACPDU is received at each link of ENNI3: field Version number is set to 0x01, field TLV_type (Actor Information) is set to 0x01, field TLV_type (Partner Information) is set to 0x02, field TLV_type (Collector Information) is set to 0x03, TLV_type (Terminator) is set to 0x00, all Reserved fields are set to 0.								
Verdict	PASS, FAIL, or INCONCLUSIVE								

7.41 MUX-Disabled Distributing in DETACHED state (Distribution)

ABSTRACT TEST CASES FOR ENNI PHASE 1									
Test Case ID	LACP_FUNCTIONALITY.XM1.1								
Reference Document Source	IEEE Std 802.3 – 2005, Clause 43.4.12, Protocol implementation conformance statement (PICS) proforma for Clause 43, Item XM1								
Test Type	Conformance								
Test Status	Conditional Mandatory								
Requirement	MUX machine as defined in Figure 43–13 and associated parameters								
Test Purpose	Verify that the Operator MEN component with ENNI functionality, after entering DETACHED state, disables distribution of the link.								
Conditions	LAG = "Yes"								
Test Topology/OVC	<p>The diagram illustrates a test topology for MUX-disabled distributing in a DETACHED state. It shows two Test Systems (represented by blue octagons) connected to an OVC13 (Operator Managed Virtual Circuit). The OVC13 is connected to an Operator MEN component. The OVC13 is connected to ENNI3 (External Network Node Interface) and UNI1 (User Network Interface). The OVC13 is connected to ENNI3 via ENNI3_OVC13_End_Point_1 and to UNI1 via UNI1_OVC13_End_Point. Below the diagram are two tables for S-VID and CE-VID mappings:</p> <table border="1"> <thead> <tr> <th>S-VID</th> <th>End Point ID</th> <th>CE-VID</th> <th>End Point ID</th> </tr> </thead> <tbody> <tr> <td>SVID34</td> <td>ENNI3_OVC13_End_Point_1</td> <td>CVID10</td> <td>UNI1_OVC13_End_Point</td> </tr> </tbody> </table>	S-VID	End Point ID	CE-VID	End Point ID	SVID34	ENNI3_OVC13_End_Point_1	CVID10	UNI1_OVC13_End_Point
S-VID	End Point ID	CE-VID	End Point ID						
SVID34	ENNI3_OVC13_End_Point_1	CVID10	UNI1_OVC13_End_Point						
Test Procedure	<p>Tester transmits a LACPDU (Request for enabling Distribution) at the link of ENNI3 configured as Active.</p> <p>Tester transmits a LACPDU (Request for detaching) at the link of ENNI3 configured as Active.</p> <p>Tester transmits test frames Flow Definition1 (Default traffic flow definition) mapped to OVC13 at UNI1.</p>								
Expected Results	Test frames are not received at the link of ENNI3 configured as Active.								
Verdict	PASS, FAIL, or INCONCLUSIVE								

7.42 MUX-Disabled Collecting in DETACHED state (Collection)

ABSTRACT TEST CASES FOR ENNI PHASE 1									
Test Case ID	LACP_FUNCTIONALITY.XM1.2								
Reference Document Source	IEEE Std 802.3 – 2005, Clause 43.4.12, Protocol implementation conformance statement (PICS) proforma for Clause 43, Item XM1								
Test Type	Conformance								
Test Status	Conditional Mandatory								
Requirement	MUX machine as defined in Figure 43–13 and associated parameters								
Test Purpose	Verify that the Operator MEN component with ENNI functionality, after entering DETACHED state, disables collection of the links.								
Conditions	LAG = "Yes"								
Test Topology/OVC	<p>The diagram illustrates a test topology for MUX-Disabled Collecting in DETACHED state. It shows two Test Systems (represented by blue octagons) connected to an OVC13 (represented by a central blue shape). The OVC13 is connected to an Operator MEN component (represented by a blue shape). The OVC13 is connected to ENNI3 (represented by a blue shape) and UNI1 (represented by a blue shape). The OVC13 is connected to ENNI3 via ENNI3_OVC13_End_Point_1 and to UNI1 via UNI1_OVC13_End_Point. The OVC13 is connected to the Operator MEN component via a dashed line. Below the diagram are two tables for S-VID and CE-VID mappings:</p> <table border="1"> <thead> <tr> <th>S-VID</th> <th>End Point ID</th> <th>CE-VID</th> <th>End Point ID</th> </tr> </thead> <tbody> <tr> <td>SVID34</td> <td>ENNI3_OVC13_End_Point_1</td> <td>CVID10</td> <td>UNI1_OVC13_End_Point</td> </tr> </tbody> </table>	S-VID	End Point ID	CE-VID	End Point ID	SVID34	ENNI3_OVC13_End_Point_1	CVID10	UNI1_OVC13_End_Point
S-VID	End Point ID	CE-VID	End Point ID						
SVID34	ENNI3_OVC13_End_Point_1	CVID10	UNI1_OVC13_End_Point						
Test Procedure	<p>Tester transmits a LACPDU (Request for enabling Distribution) at the link of ENNI3 configured as Active.</p> <p>Tester transmits a LACPDU (Request for detaching) at the link of ENNI3 configured as Active.</p> <p>Tester transmits test frames Flow Definition1 (Default traffic flow definition) mapped to OVC13 at the link of ENNI3 configured as Active.</p>								
Expected Results	Test frames are not received at UNI1.								
Verdict	PASS, FAIL, or INCONCLUSIVE								

7.43 MUX-Disabled Collecting in ATTACHED state

ABSTRACT TEST CASES FOR ENNI PHASE 1									
Test Case ID	LACP_FUNCTIONALITY.XM1.4								
Reference Document Source	IEEE Std 802.3 – 2005, Clause 43.4.12, Protocol implementation conformance statement (PICS) proforma for Clause 43, Item XM1								
Test Type	Conformance								
Test Status	Conditional Mandatory								
Requirement	MUX machine as defined in Figure 43–13 and associated parameters								
Test Purpose	Verify that the Operator MEN component with ENNI functionality, after entering ATTACHED state, disables Collecting of the links.								
Conditions	LAG = "Yes"								
Test Topology/OVC	<table border="1" style="margin-top: 10px;"> <thead> <tr> <th>S-VID</th> <th>End Point ID</th> <th>CE-VID</th> <th>End Point ID</th> </tr> </thead> <tbody> <tr> <td>SVID34</td> <td>ENNI3_OVC13_End_Point_1</td> <td>CVID10</td> <td>UNI1_OVC13_End_Point</td> </tr> </tbody> </table>	S-VID	End Point ID	CE-VID	End Point ID	SVID34	ENNI3_OVC13_End_Point_1	CVID10	UNI1_OVC13_End_Point
S-VID	End Point ID	CE-VID	End Point ID						
SVID34	ENNI3_OVC13_End_Point_1	CVID10	UNI1_OVC13_End_Point						
Test Procedure	Tester transmits test frames Flow Definition1 (Default traffic flow definition) mapped to OVC13 at the link of ENNI3 configured as Active.								
Expected Results	Test frames are not received at UNI1.								
Verdict	PASS, FAIL, or INCONCLUSIVE								

7.44 MUX-Disabled Distributing in COLLECTING state (Collection)

ABSTRACT TEST CASES FOR ENNI PHASE 1									
Test Case ID	LACP_FUNCTIONALITY.XM1.6								
Reference Document Source	IEEE Std 802.3 – 2005, Clause 43.4.12, Protocol implementation conformance statement (PICS) proforma for Clause 43, Item XM1								
Test Type	Conformance								
Test Status	Conditional Mandatory								
Requirement	MUX machine as defined in Figure 43–13 and associated parameters								
Test Purpose	Verify that the Operator MEN component with ENNI functionality, after entering COLLECTING state, disables Distributing of the links.								
Conditions	LAG = "Yes"								
Test Topology/OVC	<p>The diagram illustrates a test topology for MUX-Disabled Distributing in COLLECTING state. It shows two Test Systems (represented by blue octagons) connected to an OVC13 (Operator Managed Virtual Circuit). The OVC13 is connected to an Operator MEN component. The OVC13 is connected to ENNI3 (External Network Node Interface 3) and UNI1 (User Network Interface 1). The OVC13 is connected to ENNI3 via ENNI3_OVC13_End_Point_1 and to UNI1 via UNI1_OVC13_End_Point. Below the diagram are two tables for S-VID and CE-VID mappings:</p> <table border="1"> <thead> <tr> <th>S-VID</th> <th>End Point ID</th> <th>CE-VID</th> <th>End Point ID</th> </tr> </thead> <tbody> <tr> <td>SVID34</td> <td>ENNI3_OVC13_End_Point_1</td> <td>CVID10</td> <td>UNI1_OVC13_End_Point</td> </tr> </tbody> </table>	S-VID	End Point ID	CE-VID	End Point ID	SVID34	ENNI3_OVC13_End_Point_1	CVID10	UNI1_OVC13_End_Point
S-VID	End Point ID	CE-VID	End Point ID						
SVID34	ENNI3_OVC13_End_Point_1	CVID10	UNI1_OVC13_End_Point						
Test Procedure	Tester transmits a LACPDU (Request for enabling Collection/disabling Distribution) at the link of ENNI3 configured as Active. Tester transmits test frames Flow Definition1 (Default traffic flow definition) mapped to OVC13 at UNI1.								
Expected Results	Test frames are not received at the link of ENNI3 configured as Active.								
Verdict	PASS, FAIL, or INCONCLUSIVE								

7.45 MUX-Enabled Collecting in COLLECTING state (Collection)

ABSTRACT TEST CASES FOR ENNI PHASE 1									
Test Case ID	LACP_FUNCTIONALITY.XM1.7								
Reference Document Source	IEEE Std 802.3 – 2005, Clause 43.4.12, Protocol implementation conformance statement (PICS) proforma for Clause 43, Item XM1								
Test Type	Conformance								
Test Status	Conditional Mandatory								
Requirement	MUX machine as defined in Figure 43–13 and associated parameters								
Test Purpose	Verify that the Operator MEN component with ENNI functionality, after entering COLLECTING state, enables collection of the link.								
Conditions	LAG = "Yes"								
Test Topology/OVC	<p>The diagram illustrates the test topology for OVC13. It shows two Test Systems (represented by blue octagons) connected to an OVC13 (represented by a central blue shape). The OVC13 is connected to an Operator MEN (represented by a blue shape). The OVC13 is also connected to ENNI3 and UNI1 (represented by blue shapes). The OVC13 is connected to ENNI3 via ENNI3_OVC13_End_Point_1 and to UNI1 via UNI1_OVC13_End_Point. Below the diagram are two tables for S-VID and CE-VID.</p> <table border="1"> <thead> <tr> <th>S-VID</th> <th>End Point ID</th> <th>CE-VID</th> <th>End Point ID</th> </tr> </thead> <tbody> <tr> <td>SVID34</td> <td>ENNI3_OVC13_End_Point_1</td> <td>CVID10</td> <td>UNI1_OVC13_End_Point</td> </tr> </tbody> </table>	S-VID	End Point ID	CE-VID	End Point ID	SVID34	ENNI3_OVC13_End_Point_1	CVID10	UNI1_OVC13_End_Point
S-VID	End Point ID	CE-VID	End Point ID						
SVID34	ENNI3_OVC13_End_Point_1	CVID10	UNI1_OVC13_End_Point						
Test Procedure	Tester transmits a LACPDU (Request for enabling Collection/disabling Distribution) at the link of ENNI3 configured as Active. Tester transmits test frames Flow Definition1 (Default traffic flow definition) mapped to OVC13 at the link of ENNI3 configured as Active.								
Expected Results	All test frames are received at UNI1.								
Verdict	PASS, FAIL, or INCONCLUSIVE								

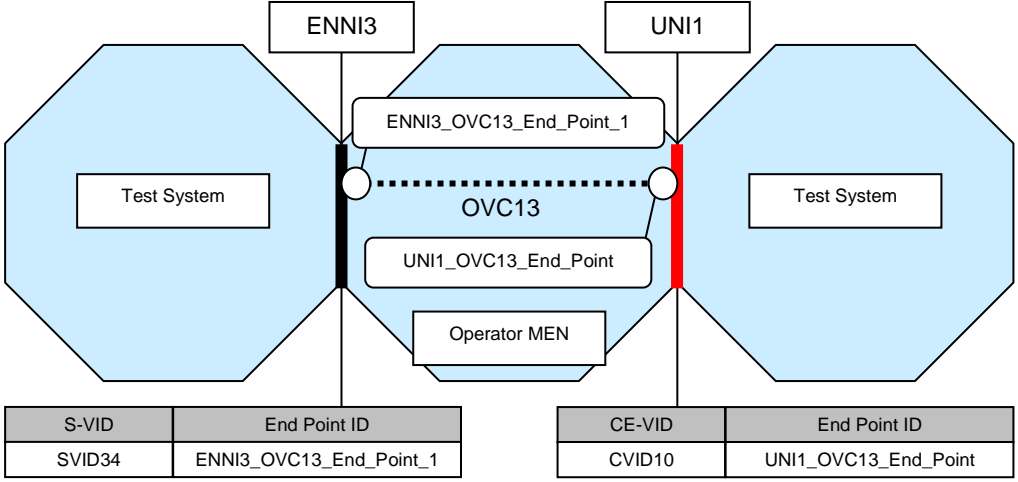

7.46 MUX-Enabled Distributing in DISTRIBUTING state (Distribution)

ABSTRACT TEST CASES FOR ENNI PHASE 1									
Test Case ID	LACP_FUNCTIONALITY.XM1.9								
Reference Document Source	IEEE Std 802.3 – 2005, Clause 43.4.12, Protocol implementation conformance statement (PICS) proforma for Clause 43, Item XM1								
Test Type	Conformance								
Test Status	Conditional Mandatory								
Requirement	MUX machine as defined in Figure 43–13 and associated parameters								
Test Purpose	Verify that the Operator MEN component with ENNI functionality, after entering DISTRIBUTING state for links on the protected ENNI, enables Distributing of the links.								
Conditions	LAG = "Yes"								
Test Topology/OVC	 <table border="1" data-bbox="427 1032 890 1108"> <thead> <tr> <th>S-VID</th> <th>End Point ID</th> </tr> </thead> <tbody> <tr> <td>SVID34</td> <td>ENNI3_OVC13_End_Point_1</td> </tr> </tbody> </table> <table border="1" data-bbox="986 1032 1449 1108"> <thead> <tr> <th>CE-VID</th> <th>End Point ID</th> </tr> </thead> <tbody> <tr> <td>CVID10</td> <td>UNI1_OVC13_End_Point</td> </tr> </tbody> </table>	S-VID	End Point ID	SVID34	ENNI3_OVC13_End_Point_1	CE-VID	End Point ID	CVID10	UNI1_OVC13_End_Point
S-VID	End Point ID								
SVID34	ENNI3_OVC13_End_Point_1								
CE-VID	End Point ID								
CVID10	UNI1_OVC13_End_Point								
Test Procedure	Tester transmits a LACPDU (Request for enabling Distribution) at the link of ENNI3 configured as Active. Tester transmits test frames Flow Definition1 (Default traffic flow definition) mapped to OVC13 at UNI1.								
Expected Results	All test frames are received at the link of ENNI3 configured as Active.								
Verdict	PASS, FAIL, or INCONCLUSIVE								

7.47 LACPDU–All reserved octets

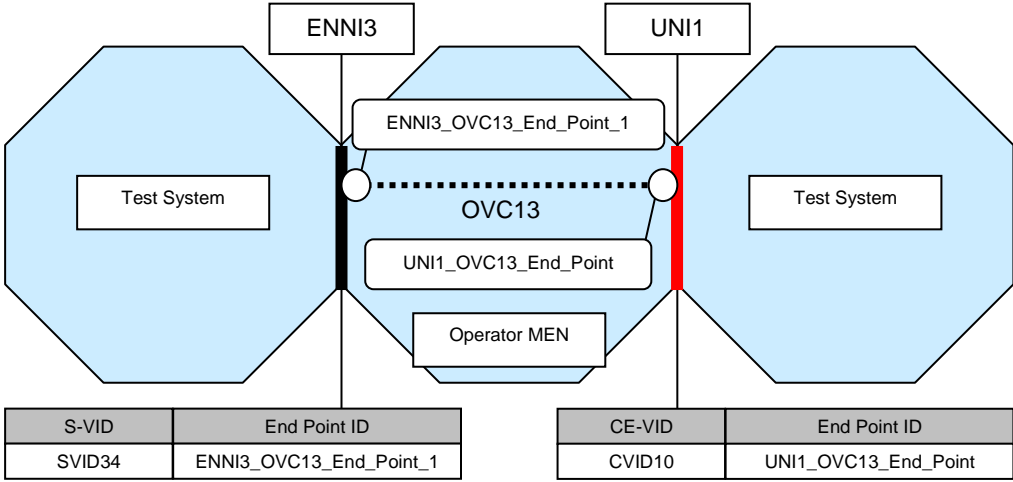
ABSTRACT TEST CASES FOR ENNI PHASE 1									
Test Case ID	LACP_FUNCTIONALITY.LPS3.1								
Reference Document Source	IEEE Std 802.3 – 2005, Clause 43.4.2, Protocol implementation conformance statement (PICS) proforma for Clause 43, Item LPS3								
Test Type	Conformance								
Test Status	Conditional Mandatory								
Requirement	These octets are reserved for use in future extensions to the protocol. They are ignored on receipt and are transmitted as zeros to claim compliance with Version 1 of this protocol								
Test Purpose	Verify that the Operator MEN component with ENNI functionality, on receipt ignores all reserved octets of LACPDU's and on transmission ensures these to be zero.								
Conditions	LAG = "Yes"								
Test Topology/OVC	 <table border="1" data-bbox="427 1064 890 1137"> <thead> <tr> <th>S-VID</th> <th>End Point ID</th> </tr> </thead> <tbody> <tr> <td>SVID34</td> <td>ENNI3_OVC13_End_Point_1</td> </tr> </tbody> </table> <table border="1" data-bbox="986 1064 1444 1137"> <thead> <tr> <th>CE-VID</th> <th>End Point ID</th> </tr> </thead> <tbody> <tr> <td>CVID10</td> <td>UNI1_OVC13_End_Point</td> </tr> </tbody> </table>	S-VID	End Point ID	SVID34	ENNI3_OVC13_End_Point_1	CE-VID	End Point ID	CVID10	UNI1_OVC13_End_Point
S-VID	End Point ID								
SVID34	ENNI3_OVC13_End_Point_1								
CE-VID	End Point ID								
CVID10	UNI1_OVC13_End_Point								
Test Procedure	Tester transmits a LACPDU (Default Configuration) at each link of ENNI3: all Reserved fields are set to 1.								
Expected Results	LACPDU is received at each link of ENNI3: all Reserved fields are set to 0.								
Verdict	PASS, FAIL, or INCONCLUSIVE								

7.48 LACPDU–Not tagged

ABSTRACT TEST CASES FOR ENNI PHASE 1									
Test Case ID	LACP_FUNCTIONALITY.LPS1.1								
Reference Document Source	IEEE Std 802.3 – 2005, Clause 43.4.2.2, Protocol implementation conformance statement (PICS) proforma for Clause 43, Item LPS1								
Test Type	Conformance								
Test Status	Conditional Mandatory								
Requirement	LACPDU's are basic IEEE 802.3 frames; they shall not be tagged								
Test Purpose	Verify that the Operator MEN component with ENNI functionality doesn't transmit tagged LACPDU's.								
Conditions	LAG = "Yes"								
Test Topology/OVC	<p>The diagram illustrates a network topology for testing LACPDU tagging. Two Test Systems are connected to an OVC13 (Operator Managed Network) via ENNI3 and UNI1. ENNI3 is connected to SVID34 and UNI1 to CVID10. The OVC13 is connected to ENNI3_OVC13_End_Point_1 and UNI1_OVC13_End_Point. An Operator MEN component is also shown. Below the diagram are two tables:</p> <table border="1"> <thead> <tr> <th>S-VID</th> <th>End Point ID</th> </tr> </thead> <tbody> <tr> <td>SVID34</td> <td>ENNI3_OVC13_End_Point_1</td> </tr> </tbody> </table> <table border="1"> <thead> <tr> <th>CE-VID</th> <th>End Point ID</th> </tr> </thead> <tbody> <tr> <td>CVID10</td> <td>UNI1_OVC13_End_Point</td> </tr> </tbody> </table>	S-VID	End Point ID	SVID34	ENNI3_OVC13_End_Point_1	CE-VID	End Point ID	CVID10	UNI1_OVC13_End_Point
S-VID	End Point ID								
SVID34	ENNI3_OVC13_End_Point_1								
CE-VID	End Point ID								
CVID10	UNI1_OVC13_End_Point								
Test Procedure	Tester transmits a LACPDU (Request for informing current states) at each link of ENNI3								
Expected Results	LACPDU is received at each link of ENNI3: frame is untagged.								
Verdict	PASS, FAIL, or INCONCLUSIVE								

7.49 LACPDU-Structure

ABSTRACT TEST CASES FOR ENNI PHASE 1									
Test Case ID	LACP_FUNCTIONALITY.LPS2.1								
Reference Document Source	IEEE Std 802.3 – 2005, Clause 43.4.2.2, Protocol implementation conformance statement (PICS) proforma for Clause 43, Item LPS2								
Test Type	Conformance								
Test Status	Conditional Mandatory								
Requirement	The LACPDU structure shall be shown in Figure 43–7 and as further described in the following field definitions								
Test Purpose	Verify that the Operator MEN component with ENNI functionality transmits LACPDU with structure as shown in [5] Figure 43–7 and as described.								
Conditions	LAG = "Yes"								
Test Topology/OVC	<p>The diagram illustrates the test topology for OVC. Two Test Systems are connected to an OVC13. The left Test System is connected to ENNI3, which is linked to SVID34. The right Test System is connected to UNI1, which is linked to CVID10. The OVC13 has two end points: ENNI3_OVC13_End_Point_1 and UNI1_OVC13_End_Point. An Operator MEN component is also connected to the OVC13. Below the diagram are two tables:</p> <table border="1"> <thead> <tr> <th>S-VID</th> <th>End Point ID</th> </tr> </thead> <tbody> <tr> <td>SVID34</td> <td>ENNI3_OVC13_End_Point_1</td> </tr> </tbody> </table> <table border="1"> <thead> <tr> <th>CE-VID</th> <th>End Point ID</th> </tr> </thead> <tbody> <tr> <td>CVID10</td> <td>UNI1_OVC13_End_Point</td> </tr> </tbody> </table>	S-VID	End Point ID	SVID34	ENNI3_OVC13_End_Point_1	CE-VID	End Point ID	CVID10	UNI1_OVC13_End_Point
S-VID	End Point ID								
SVID34	ENNI3_OVC13_End_Point_1								
CE-VID	End Point ID								
CVID10	UNI1_OVC13_End_Point								
Test Procedure	Tester transmits a LACPDU (Request for informing current states) at each link of ENNI3								
Expected Results	LACPDU is received at each link of ENNI3: frame is formatted in accordance with section 43.4.2.2 of [5].								
Verdict	PASS, FAIL, or INCONCLUSIVE								

7.50 SMV–Full Duplex

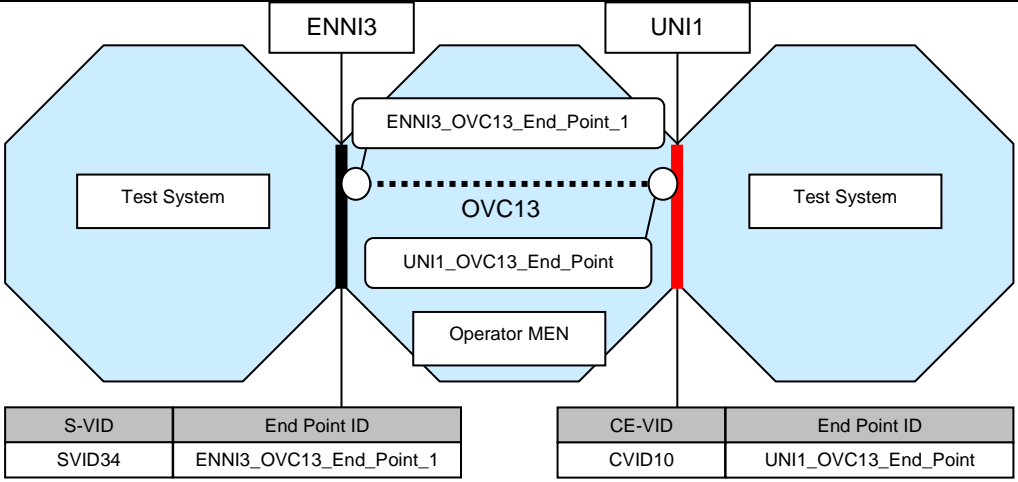
ABSTRACT TEST CASES FOR ENNI PHASE 1									
Test Case ID	LACP_FUNCTIONALITY.SMV2.3								
Reference Document Source	IEEE Std 802.3 – 2005, Clause 43.4.8, Protocol implementation conformance statement (PICS) proforma for Clause 43, Item SMV2								
Test Type	Conformance								
Test Status	Conditional Mandatory								
Requirement	LACP_Enabled is FALSE for half duplex ports, otherwise TRUE								
Test Purpose	Verify that the Operator MEN component with ENNI functionality in FULL Duplex mode asserts LACP_Enabled TRUE.								
Conditions	LAG = "Yes"								
Test Topology/OVC	 <table border="1" data-bbox="427 1010 890 1086"> <thead> <tr> <th>S-VID</th> <th>End Point ID</th> </tr> </thead> <tbody> <tr> <td>SVID34</td> <td>ENNI3_OVC13_End_Point_1</td> </tr> </tbody> </table> <table border="1" data-bbox="986 1010 1449 1086"> <thead> <tr> <th>CE-VID</th> <th>End Point ID</th> </tr> </thead> <tbody> <tr> <td>CVID10</td> <td>UNI1_OVC13_End_Point</td> </tr> </tbody> </table>	S-VID	End Point ID	SVID34	ENNI3_OVC13_End_Point_1	CE-VID	End Point ID	CVID10	UNI1_OVC13_End_Point
S-VID	End Point ID								
SVID34	ENNI3_OVC13_End_Point_1								
CE-VID	End Point ID								
CVID10	UNI1_OVC13_End_Point								
Test Procedure	Tester transmits a LACPDU (Request for informing current states) at each link of ENNI3.								
Expected Results	LACPDU is received at each link of ENNI3.								
Verdict	PASS, FAIL, or INCONCLUSIVE								

7.51 SLM–Aggregator

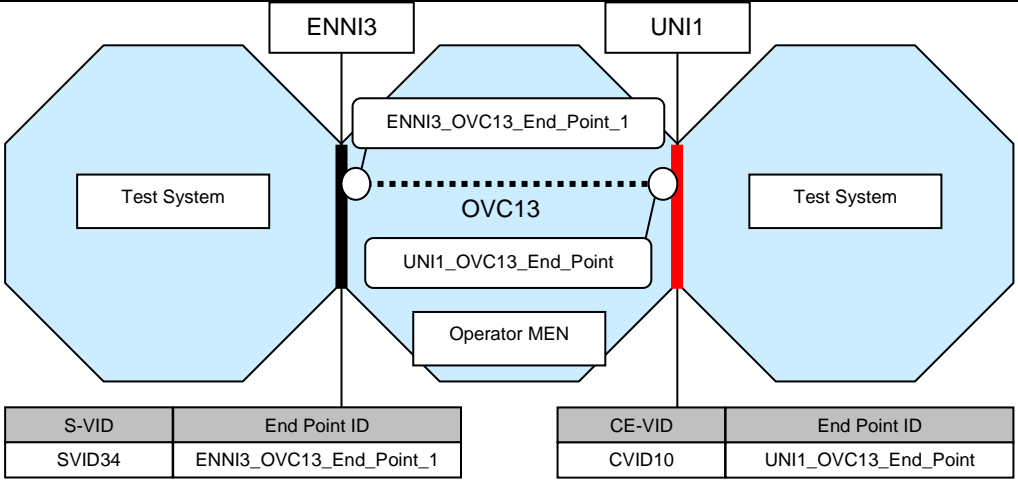
ABSTRACT TEST CASES FOR ENNI PHASE 1									
Test Case ID	LACP_FUNCTIONALITY.SLM1.1								
Reference Document Source	IEEE Std 802.3 – 2005, Clause 43.4.14.1, Protocol implementation conformance statement (PICS) proforma for Clause 43, Item SLM1								
Test Type	Conformance								
Test Status	Conditional Mandatory								
Requirement	The implementation shall support at least one Aggregator per System								
Test Purpose	Verify that the Operator MEN component with ENNI functionality supports at least one Aggregator.								
Conditions	LAG = "Yes"								
Test Topology/OVC	 <table border="1" data-bbox="427 1010 890 1086"> <thead> <tr> <th>S-VID</th> <th>End Point ID</th> </tr> </thead> <tbody> <tr> <td>SVID34</td> <td>ENNI3_OVC13_End_Point_1</td> </tr> </tbody> </table> <table border="1" data-bbox="986 1010 1449 1086"> <thead> <tr> <th>CE-VID</th> <th>End Point ID</th> </tr> </thead> <tbody> <tr> <td>CVID10</td> <td>UNI1_OVC13_End_Point</td> </tr> </tbody> </table>	S-VID	End Point ID	SVID34	ENNI3_OVC13_End_Point_1	CE-VID	End Point ID	CVID10	UNI1_OVC13_End_Point
S-VID	End Point ID								
SVID34	ENNI3_OVC13_End_Point_1								
CE-VID	End Point ID								
CVID10	UNI1_OVC13_End_Point								
Test Procedure	Tester transmits a LACPDU (Request for informing current states) at each link of ENNI3								
Expected Results	LACPDU is received at each link of ENNI3: field Actor_State.Synchronization is set to TRUE.								
Verdict	PASS, FAIL, or INCONCLUSIVE								

7.52 SLM–Port Key

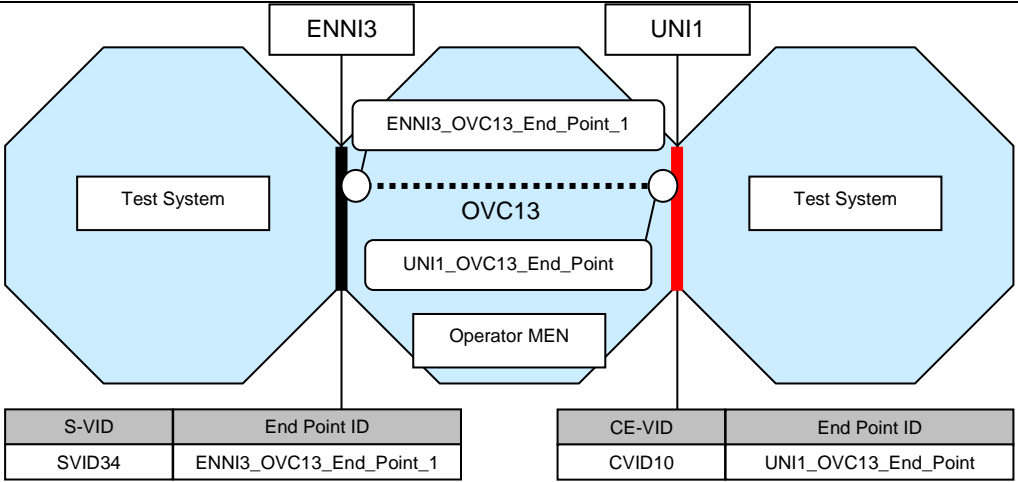
ABSTRACT TEST CASES FOR ENNI PHASE 1									
Test Case ID	LACP_FUNCTIONALITY.SLM2.1								
Reference Document Source	IEEE Std 802.3 – 2005, Clause 43.4.14.1, Protocol implementation conformance statement (PICS) proforma for Clause 43, Item SLM2								
Test Type	Conformance								
Test Status	Conditional Mandatory								
Requirement	Each Port shall be assigned an operational Key (43.3.5). Ports that can aggregate together are assigned the same operational Key as the other ports with which they can aggregate; ports that cannot aggregate with any other port are allocated unique operational Keys.								
Test Purpose	Verify that the Operator MEN component with ENNI functionality assigns each port an operational Key.								
Conditions	LAG = "Yes"								
Test Topology/OVC	 <table border="1" data-bbox="427 1070 890 1146"> <thead> <tr> <th>S-VID</th> <th>End Point ID</th> </tr> </thead> <tbody> <tr> <td>SVID34</td> <td>ENNI3_OVC13_End_Point_1</td> </tr> </tbody> </table> <table border="1" data-bbox="986 1070 1449 1146"> <thead> <tr> <th>CE-VID</th> <th>End Point ID</th> </tr> </thead> <tbody> <tr> <td>CVID10</td> <td>UNI1_OVC13_End_Point</td> </tr> </tbody> </table>	S-VID	End Point ID	SVID34	ENNI3_OVC13_End_Point_1	CE-VID	End Point ID	CVID10	UNI1_OVC13_End_Point
S-VID	End Point ID								
SVID34	ENNI3_OVC13_End_Point_1								
CE-VID	End Point ID								
CVID10	UNI1_OVC13_End_Point								
Test Procedure	Tester transmits a LACPDU (Request for informing current states) at each link of ENNI3								
Expected Results	LACPDU is received at each link of ENNI3: field Actor_Key is present (value as default configured)								
Verdict	PASS, FAIL, or INCONCLUSIVE								

7.53 SLM–Keys same for Aggregator

ABSTRACT TEST CASES FOR ENNI PHASE 1									
Test Case ID	LACP_FUNCTIONALITY.SLM5.2								
Reference Document Source	IEEE Std 802.3 – 2005, Clause 43.4.14.1, Protocol implementation conformance statement (PICS) proforma for Clause 43, Item SLM5								
Test Type	Conformance								
Test Status	Conditional Mandatory								
Requirement	A Port shall only select an Aggregator that has the same operational Key assignment as its own operational Key								
Test Purpose	Verify that the Operator MEN component with ENNI functionality, when a port has the same Key value as a Aggregator, attaches it to the Aggregator.								
Conditions	LAG = "Yes"								
Test Topology/OVC	<p>The diagram illustrates a network topology for testing LACP functionality. Two Test Systems are connected to an OVC13 (Operator MEN component) via ENNI3 and UNI1. The OVC13 has two end points: ENNI3_OVC13_End_Point_1 and UNI1_OVC13_End_Point. Below the diagram are two tables:</p> <table border="1"> <thead> <tr> <th>S-VID</th> <th>End Point ID</th> </tr> </thead> <tbody> <tr> <td>SVID34</td> <td>ENNI3_OVC13_End_Point_1</td> </tr> </tbody> </table> <table border="1"> <thead> <tr> <th>CE-VID</th> <th>End Point ID</th> </tr> </thead> <tbody> <tr> <td>CVID10</td> <td>UNI1_OVC13_End_Point</td> </tr> </tbody> </table>	S-VID	End Point ID	SVID34	ENNI3_OVC13_End_Point_1	CE-VID	End Point ID	CVID10	UNI1_OVC13_End_Point
S-VID	End Point ID								
SVID34	ENNI3_OVC13_End_Point_1								
CE-VID	End Point ID								
CVID10	UNI1_OVC13_End_Point								
Test Procedure	Tester transmits a LACPDU (Request for informing current states) at each link of ENNI3								
Expected Results	LACPDUs are received at ENNI3: all frames with field Actor_State.Synchronization set to TRUE have the same value of the field Actor_Key.								
Verdict	PASS, FAIL, or INCONCLUSIVE								

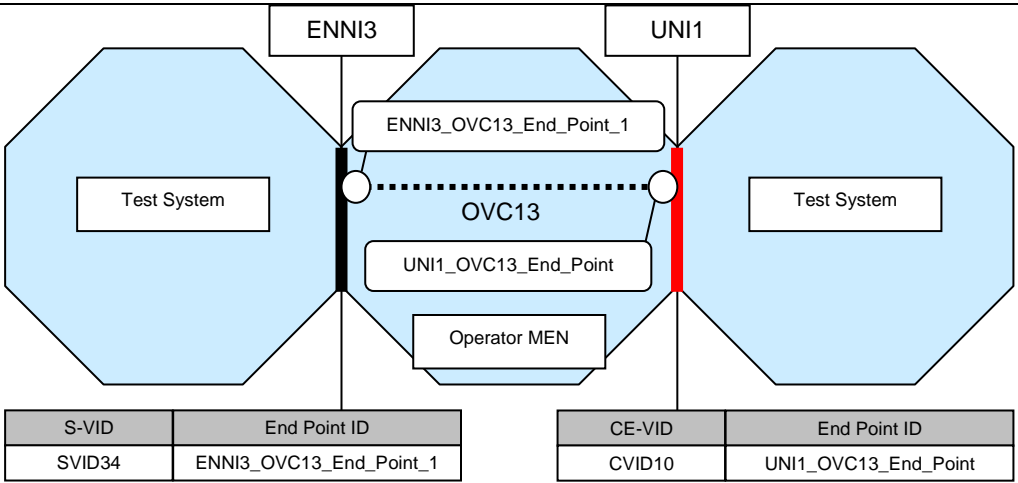

7.54 SLM–Keys same for LAG

ABSTRACT TEST CASES FOR ENNI PHASE 1	
Test Case ID	LACP_FUNCTIONALITY.SLM6.1
Reference Document Source	IEEE Std 802.3 – 2005, Clause 43.4.14.1, Protocol implementation conformance statement (PICS) proforma for Clause 43, Item SLM6
Test Type	Conformance
Test Status	Conditional Mandatory
Requirement	Subject to the exception stated in item g), ports that are members of the same Link Aggregation Group (i.e., two or more ports that have the same Actor_System_ID, Actor_Key, Partner_System ID, and Partner Key, and that are not required to be Individual) shall select the same Aggregator.
Test Purpose	Verify that the Operator MEN component with ENNI functionality, when links have the same LAG ID value, attaches them to the same Aggregator.
Conditions	LAG = "Yes"
Test Topology/OVC	
Test Procedure	Tester transmits a LACPDU (Request for detaching) at the link of ENNI3 configured as Active. Tester transmits a LACPDU (Request for informing current states) at each link of ENNI3
Expected Results	LACPDUs are received at ENNI3: all frames with field Actor_State.Synchronization set to TRUE have identical values in the fields Actor_System_Priority, Actor_System, Actor_Key, Partner_System_Priority, Partner_System and Partner_Key <sup>4</sup>
Verdict	PASS, FAIL, or INCONCLUSIVE

<sup>4</sup> These six values comprise the LAG Identity, as defined in [802.3 – 2005], section 43.3.6.

7.55 SLM–Not select the same Aggregator

ABSTRACT TEST CASES FOR ENNI PHASE 1									
Test Case ID	LACP_FUNCTIONALITY.SLM9.1								
Reference Document Source	IEEE Std 802.3 – 2005, Clause 43.4.14.1, Protocol implementation conformance statement (PICS) proforma for Clause 43, Item SLM9								
Test Type	Conformance								
Test Status	Conditional Mandatory								
Requirement	Any port that is Aggregateable shall not select an Aggregator to which an Individual port is already attached.								
Test Purpose	Verify that the Operator MEN component with ENNI functionality when an Individual port is attached to an Aggregator with, doesn't select this Aggregator for an Aggregateable port.								
Conditions	LAG = "Yes"								
Test Topology/OVC	<table border="1" style="margin-top: 10px;"> <thead> <tr> <th>S-VID</th> <th>End Point ID</th> </tr> </thead> <tbody> <tr> <td>SVID34</td> <td>ENNI3_OVC13_End_Point_1</td> </tr> </tbody> </table> <table border="1" style="margin-top: 10px;"> <thead> <tr> <th>CE-VID</th> <th>End Point ID</th> </tr> </thead> <tbody> <tr> <td>CVID10</td> <td>UNI1_OVC13_End_Point</td> </tr> </tbody> </table>	S-VID	End Point ID	SVID34	ENNI3_OVC13_End_Point_1	CE-VID	End Point ID	CVID10	UNI1_OVC13_End_Point
S-VID	End Point ID								
SVID34	ENNI3_OVC13_End_Point_1								
CE-VID	End Point ID								
CVID10	UNI1_OVC13_End_Point								
Test Procedure	<p>Tester transmits a LACPDU (Request for being Individual) at the link of ENNI3 configured as Active.</p> <p>Tester transmits a LACPDU (Request for informing current states) at each link of ENNI3</p>								
Expected Results	<p>LACPDU is received at the link of ENNI3 configured as Active: field Partner_State.LACP_Aggregation is set to FALSE, field Actor_State.Synchronization is set to FALSE.</p> <p>LACPDU is received at the link of ENNI3 configured as Standby: field Partner_State.LACP_Aggregation is set to TRUE, field Actor_State.Synchronization is set to TRUE.</p>								
Verdict	PASS, FAIL, or INCONCLUSIVE								

7.56 PM-SLOW to FAST periodic

ABSTRACT TEST CASES FOR ENNI PHASE 1									
Test Case ID	TIMERS.PM1.3								
Reference Document Source	IEEE Std 802.3 – 2005, Clause 43.4.13, Protocol implementation conformance statement (PICS) proforma for Clause 43, Item PM1								
Test Type	Conformance								
Test Status	Conditional Mandatory								
Requirement	Periodic Transmission machine as defined in Figure 43–11 and associated parameters								
Test Purpose	Verify that the Operator MEN component with ENNI functionality, on receipt of a LACPDU carrying Actor_State.LACP_Timeout=Short at each link on the protected ENNI, enters FAST_PERIODIC.								
Conditions	LAG = "Yes"								
Test Topology/OVC	<table border="1" style="width: 100%; margin-top: 10px;"> <tr> <th>S-VID</th> <th>End Point ID</th> <th>CE-VID</th> <th>End Point ID</th> </tr> <tr> <td>SVID34</td> <td>ENNI3_OVC13_End_Point_1</td> <td>CVID10</td> <td>UNI1_OVC13_End_Point</td> </tr> </table>	S-VID	End Point ID	CE-VID	End Point ID	SVID34	ENNI3_OVC13_End_Point_1	CVID10	UNI1_OVC13_End_Point
S-VID	End Point ID	CE-VID	End Point ID						
SVID34	ENNI3_OVC13_End_Point_1	CVID10	UNI1_OVC13_End_Point						
Test Procedure	Tester transmits a LACPDU (Request for Fast Mode) at each link of ENNI3 Tester listens for up to (4 x Fast_Periodic_Time) seconds at ENNI3								
Expected Results	At least two LACPDU are received at each link of ENNI3: the arrival timestamp difference between two consecutive frames received at the same link equals Fast_Periodic_Time.								
Verdict	PASS, FAIL, or INCONCLUSIVE								

7.57 PM-FAST to SLOW periodic

ABSTRACT TEST CASES FOR ENNI PHASE 1									
Test Case ID	TIMERS.PM1.4								
Reference Document Source	IEEE Std 802.3 – 2005, Clause 43.4.13, Protocol implementation conformance statement (PICS) proforma for Clause 43, Item PM1								
Test Type	Conformance								
Test Status	Conditional Mandatory								
Requirement	Periodic Transmission machine as defined in Figure 43–11 and associated parameters								
Test Purpose	Verify that the Operator MEN component with ENNI functionality, on receipt of a LACPDU carrying Actor_State.LACP_Timeout=Long at each link on the protected ENNI, enters SLOW_PERIODIC.								
Conditions	LAG = "Yes"								
Test Topology/OVC	<table border="1" style="width: 100%; margin-top: 10px;"> <tr> <th>S-VID</th> <th>End Point ID</th> <th>CE-VID</th> <th>End Point ID</th> </tr> <tr> <td>SVID34</td> <td>ENNI3_OVC13_End_Point_1</td> <td>CVID10</td> <td>UNI1_OVC13_End_Point</td> </tr> </table>	S-VID	End Point ID	CE-VID	End Point ID	SVID34	ENNI3_OVC13_End_Point_1	CVID10	UNI1_OVC13_End_Point
S-VID	End Point ID	CE-VID	End Point ID						
SVID34	ENNI3_OVC13_End_Point_1	CVID10	UNI1_OVC13_End_Point						
Test Procedure	Tester transmits a LACPDU (Default Configuration) at each link of ENNI3 Tester listens for up to (4 x Slow_Periodic_Time) seconds at ENNI3								
Expected Results	At least two LACPDU are received at each link of ENNI3: the arrival timestamp difference between two consecutive frames received at the same link equals Slow_Periodic_Time.								
Verdict	PASS, FAIL, or INCONCLUSIVE								

7.58 RM-Current\_While\_timer expired

ABSTRACT TEST CASES FOR ENNI PHASE 1									
Test Case ID	TIMERS.RM1								
Reference Document Source	IEEE Std 802.3 – 2005, Clause 43.4.12, Protocol implementation conformance statement (PICS) proforma for Clause 43, Item RM1								
Test Type	Conformance								
Test Status	Conditional Mandatory								
Requirement	Receive machine as defined in Figure 43–10 and associated parameters								
Test Purpose	Verify that the Operator MEN component with ENNI functionality, after current_while_timer expired at CURRENT state and expired again at EXPIRED state, enters FAST_PERIODIC state.								
Conditions	LAG = "Yes"								
Test Topology/OVC	<table border="1" style="width: 100%; margin-top: 10px;"> <tr> <th>S-VID</th> <th>End Point ID</th> <th>CE-VID</th> <th>End Point ID</th> </tr> <tr> <td>SVID34</td> <td>ENNI3_OVC13_End_Point_1</td> <td>CVID10</td> <td>UNI1_OVC13_End_Point</td> </tr> </table>	S-VID	End Point ID	CE-VID	End Point ID	SVID34	ENNI3_OVC13_End_Point_1	CVID10	UNI1_OVC13_End_Point
S-VID	End Point ID	CE-VID	End Point ID						
SVID34	ENNI3_OVC13_End_Point_1	CVID10	UNI1_OVC13_End_Point						
Test Procedure	Tester transmits a LACPDU (Default Configuration) at each link of ENNI3. Tester listens for up to (Long_Timeout_Time + LACP process time + LACPDU listen time + Fast_Periodic_time)								
Expected Results	At least one LACPDU is received at each link of ENNI3								
Verdict	PASS, FAIL, or INCONCLUSIVE								

7.59 Frame Collector–discard frames within a CollectorMaxDelay time

ABSTRACT TEST CASES FOR ENNI PHASE 1									
Test Case ID	TIMERS.FC2.1								
Reference Document Source	IEEE Std 802.3 – 2005, Clause 43.2.3; Protocol implementation conformance statement (PICS) proforma for Clause 43, Item FC2								
Test Type	Conformance								
Test Status	Conditional Mandatory								
Requirement	In order to ensure that frame delivery is not delayed indefinitely (which could cause a frame ordering problem when moving conversations from one link to another), the Frame Collector shall, upon receiving a frame from an Aggregator Parser, either deliver the frame to its MAC Client, or discard the frame within a CollectorMaxDelay time.								
Test Purpose	Verify that the Operator MEN component with ENNI functionality delivers or discards frame within a CollectorMaxDelay time.								
Conditions	LAG = "Yes"								
Test Topology/OVC	<table border="1" style="width: 100%; margin-top: 10px;"> <thead> <tr> <th>S-VID</th> <th>End Point ID</th> <th>CE-VID</th> <th>End Point ID</th> </tr> </thead> <tbody> <tr> <td>SVID34</td> <td>ENNI3_OVC13_End_Point_1</td> <td>CVID10</td> <td>UNI1_OVC13_End_Point</td> </tr> </tbody> </table>	S-VID	End Point ID	CE-VID	End Point ID	SVID34	ENNI3_OVC13_End_Point_1	CVID10	UNI1_OVC13_End_Point
S-VID	End Point ID	CE-VID	End Point ID						
SVID34	ENNI3_OVC13_End_Point_1	CVID10	UNI1_OVC13_End_Point						
Test Procedure	<ol style="list-style-type: none"> <li>Tester transmits a LACPDU (Request for enabling Distribution) at each link of ENNI3.</li> <li>Tester transmits test frames mapped to OVC13 at ENNI3.</li> <li>Wait for (CollectorMaxDelay + D2 - D1), where D1 is the delay of frames transmission from ENNI to EIs without Link Aggregation entity, D2 is the Delay of frames transmission from ENNI to EIs with Link Aggregation entity.</li> <li>Wait for until timeout of Test Case Execution Time .</li> </ol>								
Expected Results	<ol style="list-style-type: none"> <li>2-3. All test frames are received at UNI1, mapped to OVC13.</li> <li>4. No test frames are received on the standby or active link of ENNI3 or at UNI1.</li> </ol>								
Verdict	PASS, FAIL, or INCONCLUSIVE								

8 Test Group: CE-VLAN ID Preservation

**8.1 CE-VLAN ID Preservation for Untagged Service Frames – All OVC UNI’s**  
**CE-VLAN IDs Map to the OVC**

ABSTRACT TEST CASES FOR ENNI PHASE 1													
Test Case ID	OVC_ATTRIBUTES.R35.1												
Reference Document Source	MEF 26, R35												
Test Status	Conditional Mandatory												
Requirement	When an OVC has the CE-VLAN ID Preservation attribute with a value of Yes and all of the UNIs with an OVC End Point associated by the OVC are such that all CE-VLAN IDs map to the OVC End Point (see Section 7.5.2 of [MEF 26]), then the relationship between the format of the frame at the ingress External Interface and the corresponding frame at the egress External Interface MUST be as specified in Table 5 of [MEF 26].												
Test Purpose	Verify that CE-VLAN ID is preserved for untagged Service Frames if CE-VLAN ID Preservation attribute has a value of Yes for that OVC and all OVC UNI’s CE-VLAN IDs map to that OVC. (Row 1 and 2 of Table 5 of [MEF 26])												
Conditions	CE-VLAN ID Preservation = "Yes", All OVC UNI’s CE-VLAN IDs map to the OVC = "Yes", Number of UNI OVC End Points > 2												
Test Topology/OVC	<p>The diagram illustrates a network topology for testing CE-VLAN ID preservation. It features three Test Systems (represented by blue octagons) connected to a central OVC5 (Operator MEN). The OVC5 is connected to three External Network Interfaces (ENIs): ENNI1, UNI3, and UNI4. Each UNI is associated with a specific CE-VLAN ID and End Point ID. The OVC5 is also connected to a central OVC5 End Point. The diagram shows the flow of untagged broadcast test frames from the Test Systems through the OVC5 to the ENIs. The OVC5 is highlighted in red.</p> <table border="1"> <thead> <tr> <th>S-VID</th> <th>End Point ID</th> </tr> </thead> <tbody> <tr> <td>SVID7</td> <td>ENNI1_OVC5_End_Point_1</td> </tr> </tbody> </table> <table border="1"> <thead> <tr> <th>CE-VID</th> <th>End Point ID</th> </tr> </thead> <tbody> <tr> <td>All</td> <td>UNI3_OVC5_End_Point</td> </tr> </tbody> </table> <table border="1"> <thead> <tr> <th>CE-VID</th> <th>End Point ID</th> </tr> </thead> <tbody> <tr> <td>All</td> <td>UNI4_OVC5_End_Point</td> </tr> </tbody> </table>	S-VID	End Point ID	SVID7	ENNI1_OVC5_End_Point_1	CE-VID	End Point ID	All	UNI3_OVC5_End_Point	CE-VID	End Point ID	All	UNI4_OVC5_End_Point
S-VID	End Point ID												
SVID7	ENNI1_OVC5_End_Point_1												
CE-VID	End Point ID												
All	UNI3_OVC5_End_Point												
CE-VID	End Point ID												
All	UNI4_OVC5_End_Point												
Test Procedure	Tester transmits untagged broadcast test frames mapped to OVC5 at UNI3												
Expected Results	All test frames are received at UNI4; frames are untagged, preserving the CE-VLAN ID. All test frames are received at ENNI1 S-tagged only, preserving the CE-VLAN ID.												
Verdict	PASS, FAIL, or INCONCLUSIVE												

8.2 CE-VLAN ID Preservation for Untagged Service Frames – All OVC UNI’s

CE-VLAN IDs Map to the OVC

ABSTRACT TEST CASES FOR ENNI PHASE 1													
Test Case ID	OVC_ATTRIBUTES.R35.2												
Reference Document Source	MEF 26, R35												
Test Status	Conditional Mandatory												
Requirement	When an OVC has the CE-VLAN ID Preservation attribute with a value of Yes and all of the UNIs with an OVC End Point associated by the OVC are such that all CE-VLAN IDs map to the OVC End Point (see Section 7.5.2 of [MEF 26]), then the relationship between the format of the frame at the ingress External Interface and the corresponding frame at the egress External Interface MUST be as specified in Table 5 of [MEF 26].												
Test Purpose	Verify that the format of the ingress untagged Service Frames are forwarded unchanged to the single S-Tag at the Egress ENNI after the S tag was inserted. The CE-VLAN ID Preservation has a value of Yes for that OVC and all OVC UNI’s CE-VLAN IDs map to that OVC. (Row 2 of Table 5 of [MEF 26]– alternative configuration for point-to-point OVCs)												
Features/Conditions	CE-VLAN ID Preservation = "Yes", Number of UNI OVC End Points > 0, All OVC UNI’s CE-VLAN IDs map to the OVC = "Yes", Untagged frames at UNI = "Yes"												
Test Topology/OVC	<p>The diagram illustrates a network topology for testing CE-VLAN ID preservation. It features three Test Systems (represented by blue octagons) connected to three External Network Network Interfaces (ENNI1, UNI3, and UNI4). ENNI1 and UNI3 are connected to an Operator MEN. UNI4 is connected to an OVC5. The diagram includes three tables showing the mapping of S-VID and CE-VID to specific End Point IDs:</p> <table border="1" style="display: inline-table; margin-right: 20px;"> <thead> <tr> <th>S-VID</th> <th>End Point ID</th> </tr> </thead> <tbody> <tr> <td>SVID7</td> <td>ENNI1_OVC5_End_Point_1</td> </tr> </tbody> </table> <table border="1" style="display: inline-table; margin-right: 20px;"> <thead> <tr> <th>CE-VID</th> <th>End Point ID</th> </tr> </thead> <tbody> <tr> <td>All</td> <td>UNI3_OVC5_End_Point</td> </tr> </tbody> </table> <table border="1"> <thead> <tr> <th>CE-VID</th> <th>End Point ID</th> </tr> </thead> <tbody> <tr> <td>All</td> <td>UNI4_OVC5_End_Point</td> </tr> </tbody> </table>	S-VID	End Point ID	SVID7	ENNI1_OVC5_End_Point_1	CE-VID	End Point ID	All	UNI3_OVC5_End_Point	CE-VID	End Point ID	All	UNI4_OVC5_End_Point
S-VID	End Point ID												
SVID7	ENNI1_OVC5_End_Point_1												
CE-VID	End Point ID												
All	UNI3_OVC5_End_Point												
CE-VID	End Point ID												
All	UNI4_OVC5_End_Point												
Test Procedure	Tester transmits untagged test frames at UNI4 that are mapped to OVC5.												
Expected Results	All test frames are received at ENNI1: frames are single-tagged, S-VLAN ID is mapped to OVC5 at ENNI1.												
Verdict	PASS, FAIL, or INCONCLUSIVE												



8.3 CE-VLAN ID Preservation for C-tagged Service Frames – All OVC UNI’s

CE-VLAN IDs Map to the OVC

ABSTRACT TEST CASES FOR ENNI PHASE 1													
Test Case ID	OVC_ATTRIBUTES.R35.3												
Reference Document Source	MEF 26, R35												
Test Status	Conditional Mandatory												
Requirement	When an OVC has the CE-VLAN ID Preservation attribute with a value of Yes and all of the UNIs with an OVC End Point associated by the OVC are such that all CE-VLAN IDs map to the OVC End Point (see Section 7.5.2 of [MEF 26]), then the relationship between the format of the frame at the ingress External Interface and the corresponding frame at the egress External Interface MUST be as specified in Table 5 of [MEF 26].												
Test Purpose	Verify that CE-VLAN ID is preserved for C-tagged Service Frames if CE-VLAN ID Preservation attribute has a value of Yes for that OVC and all OVC UNI’s CE-VLAN IDs map to that OVC. (Rows 3 and 4 of Table 5 of [MEF 26])												
Conditions	CE-VLAN ID Preservation = "Yes", All OVC UNI’s CE-VLAN IDs map to the OVC = "Yes"												
Test Topology/OVC	<p>The diagram illustrates a network topology for testing CE-VLAN ID preservation. It features three Test Systems (represented by blue octagons) connected to a central OVC5 (Operator MEN). The OVC5 is connected to three External Network Interfaces (ENIs): ENNI1, UNI3, and UNI4. Each ENI is associated with a specific CE-VLAN ID (CE-VID) and an End Point ID. The OVC5 is also associated with a specific End Point ID. The diagram shows the flow of C-tagged service frames from the Test Systems through the OVC5 to the ENIs. The OVC5 is connected to ENNI1, UNI3, and UNI4. The OVC5 is also connected to ENNI1, UNI3, and UNI4. The OVC5 is also connected to ENNI1, UNI3, and UNI4.</p> <table border="1" style="display: inline-table; margin-right: 20px;"> <thead> <tr> <th>S-VID</th> <th>End Point ID</th> </tr> </thead> <tbody> <tr> <td>SVID7</td> <td>ENNI1_OVC5_End_Point_1</td> </tr> </tbody> </table> <table border="1" style="display: inline-table; margin-right: 20px;"> <thead> <tr> <th>CE-VID</th> <th>End Point ID</th> </tr> </thead> <tbody> <tr> <td>All</td> <td>UNI3_OVC5_End_Point</td> </tr> </tbody> </table> <table border="1" style="display: inline-table;"> <thead> <tr> <th>CE-VID</th> <th>End Point ID</th> </tr> </thead> <tbody> <tr> <td>All</td> <td>UNI4_OVC5_End_Point</td> </tr> </tbody> </table>	S-VID	End Point ID	SVID7	ENNI1_OVC5_End_Point_1	CE-VID	End Point ID	All	UNI3_OVC5_End_Point	CE-VID	End Point ID	All	UNI4_OVC5_End_Point
S-VID	End Point ID												
SVID7	ENNI1_OVC5_End_Point_1												
CE-VID	End Point ID												
All	UNI3_OVC5_End_Point												
CE-VID	End Point ID												
All	UNI4_OVC5_End_Point												
Test Procedure	Tester transmits C-Tag test frames at UNI3 that are mapped to OVC5.												
Expected Results	All test frames are received at UNI4: frames carry a C-Tag preserving the original CE-VLAN ID. All test frames are received at ENNI1 double-tagged, preserving the original CE-VLAN ID.												
Verdict	PASS, FAIL, or INCONCLUSIVE												

8.4 CE-VLAN ID Preservation for C-tagged Service Frames –All OVC UNI’s

CE-VLAN IDs Map to the OVC

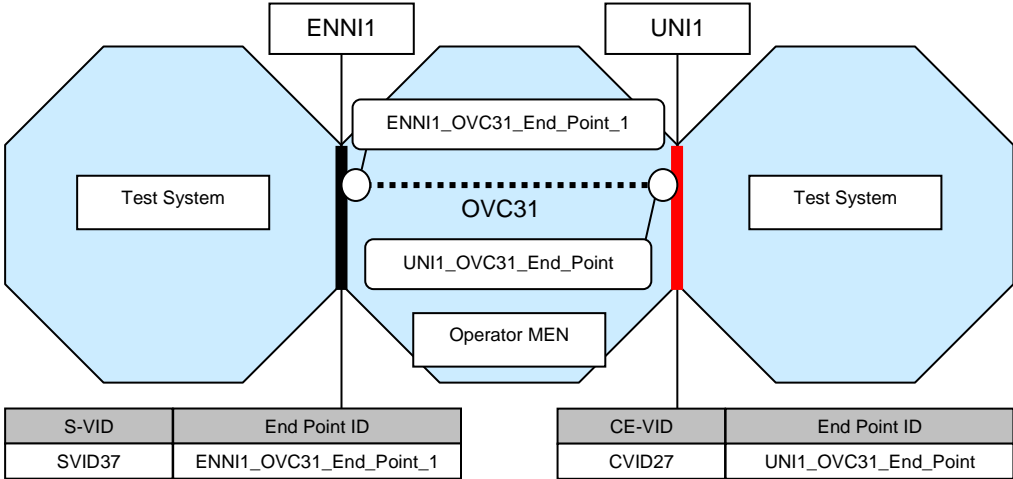
ABSTRACT TEST CASES FOR ENNI PHASE 1									
Test Case ID	OVC_ATTRIBUTES.R35.4								
Reference Document Source	MEF 26, R35								
Test Status	Conditional Mandatory								
Requirement	When an OVC has the CE-VLAN ID Preservation attribute with a value of Yes and all of the UNIs with an OVC End Point associated by the OVC are such that all CE-VLAN IDs map to the OVC End Point (see Section 7.5.2 of [MEF 26]), then the relationship between the format of the frame at the ingress External Interface and the corresponding frame at the egress External Interface MUST be as specified in Table 5 of [MEF 26].								
Test Purpose	Verify that CE-VLAN ID is preserved for C-tagged Service frames if CE-VLAN ID Preservation attribute has a value of Yes for that OVC and all OVC UNI’s CE-VLAN IDs map to that OVC. (Row 4 of Table 5 of [MEF 26], alternative test case for point-to-point OVCs)								
Features/Conditions	CE-VLAN ID Preservation = "Yes", Number of UNI OVC End Points > 0, All OVC UNI’s CE-VLAN IDs map to the OVC = "Yes", Tagged frames at UNI = "Yes"								
Test Topology/OVC	 <table border="1" data-bbox="427 1288 890 1361"> <thead> <tr> <th>S-VID</th> <th>End Point ID</th> </tr> </thead> <tbody> <tr> <td>SVID37</td> <td>ENNI1_OVC31_End_Point_1</td> </tr> </tbody> </table> <table border="1" data-bbox="986 1288 1444 1361"> <thead> <tr> <th>CE-VID</th> <th>End Point ID</th> </tr> </thead> <tbody> <tr> <td>CVID27</td> <td>UNI1_OVC31_End_Point</td> </tr> </tbody> </table>	S-VID	End Point ID	SVID37	ENNI1_OVC31_End_Point_1	CE-VID	End Point ID	CVID27	UNI1_OVC31_End_Point
S-VID	End Point ID								
SVID37	ENNI1_OVC31_End_Point_1								
CE-VID	End Point ID								
CVID27	UNI1_OVC31_End_Point								
Test Procedure	Tester transmits C-tagged test frames at UNI1 that are mapped to OVC31.								
Expected Results	All test frames are received at ENNI1: frames are double-tagged, with the original CE-VLAN ID preserved, S-VLAN ID is mapped to OVC5 at ENNI1.								
Verdict	PASS, FAIL, or INCONCLUSIVE								

8.5 CE-VLAN ID Preservation for ENNI Frames With S- and C-tag – All OVC

UNI's CE-VLAN IDs Map to the OVC

ABSTRACT TEST CASES FOR ENNI PHASE 1									
Test Case ID	OVC_ATTRIBUTES.R35.5								
Reference Document Source	MEF 26, R35								
Test Status	Conditional Mandatory								
Requirement	When an OVC has the CE-VLAN ID Preservation attribute with a value of Yes and all of the UNIs with an OVC End Point associated by the OVC are such that all CE-VLAN IDs map to the OVC End Point (see Section 7.5.2 of [MEF 26]), then the relationship between the format of the frame at the ingress External Interface and the corresponding frame at the egress External Interface MUST be as specified in Table 5 of [MEF 26].								
Test Purpose	Verify that the ENNI Frames with S- and C-tags are forwarded to the UNI after the S-Tag was deleted. The CE-VLAN ID Preservation attribute has a value of Yes for that OVC and all OVC UNI's CE-VLAN IDs map to that OVC. (Row 5 of Table 5 of [MEF 26])								
Conditions	CE-VLAN ID Preservation = "Yes", All OVC UNI's CE-VLAN IDs map to the OVC = "Yes", Tagged frames at UNI = "Yes"								
Test Topology/OVC	<table border="1" style="width: 100%; margin-top: 10px;"> <tr> <td style="width: 50%;">S-VID</td> <td style="width: 50%;">End Point ID</td> <td style="width: 50%;">CE-VID</td> <td style="width: 50%;">End Point ID</td> </tr> <tr> <td>SVID37</td> <td>ENNI1_OVC31_End_Point_1</td> <td>CVID27</td> <td>UNI1_OVC31_End_Point</td> </tr> </table>	S-VID	End Point ID	CE-VID	End Point ID	SVID37	ENNI1_OVC31_End_Point_1	CVID27	UNI1_OVC31_End_Point
S-VID	End Point ID	CE-VID	End Point ID						
SVID37	ENNI1_OVC31_End_Point_1	CVID27	UNI1_OVC31_End_Point						
Test Procedure	Tester transmits double-tagged test frames mapped to OVC31 at ENNI1, with C-VLAN ID set to CVID27.								
Expected Results	All test frames are received at their destination UNIs: Frames are C-tagged with the original C-VLAN ID preserved.								
Verdict	PASS, FAIL, or INCONCLUSIVE								

8.6 CE-VLAN ID Preservation for ENNI Frames With S-Tag Only – All OVC

UNI's CE-VLAN IDs Map to the OVC

ABSTRACT TEST CASES FOR ENNI PHASE 1									
Test Case ID	OVC_ATTRIBUTES.R35.6								
Reference Document Source	MEF 26, R35								
Test Status	Conditional Mandatory								
Requirement	When an OVC has the CE-VLAN ID Preservation attribute with a value of Yes and all of the UNIs with an OVC End Point associated by the OVC are such that all CE-VLAN IDs map to the OVC End Point (see Section 7.5.2 of [MEF 26]), then the relationship between the format of the frame at the ingress External Interface and the corresponding frame at the egress External Interface MUST be as specified in Table 5 of [MEF 26].								
Test Purpose	Verify that the ENNI Frames with S-Tag only are forwarded unchanged to the UNI after the S-Tag was deleted. The CE-VLAN ID Preservation attribute has a value of Yes for that OVC and all OVC UNI's CE-VLAN IDs map to that OVC. (Row 6 of Table 5 of [MEF 26])								
Conditions	CE-VLAN ID Preservation = "Yes" All OVC UNI's CE-VLAN IDs map to the OVC = "Yes"								
Test Topology/OVC	<table border="1" style="margin-top: 10px;"> <thead> <tr> <th>S-VID</th> <th>End Point ID</th> </tr> </thead> <tbody> <tr> <td>SVID37</td> <td>ENNI1_OVC31_End_Point_1</td> </tr> </tbody> </table> <table border="1" style="margin-top: 10px;"> <thead> <tr> <th>CE-VID</th> <th>End Point ID</th> </tr> </thead> <tbody> <tr> <td>CVID27</td> <td>UNI1_OVC31_End_Point</td> </tr> </tbody> </table>	S-VID	End Point ID	SVID37	ENNI1_OVC31_End_Point_1	CE-VID	End Point ID	CVID27	UNI1_OVC31_End_Point
S-VID	End Point ID								
SVID37	ENNI1_OVC31_End_Point_1								
CE-VID	End Point ID								
CVID27	UNI1_OVC31_End_Point								
Test Procedure	Tester transmits single S-tagged test frames that are mapped to OVC31 at ENNI1.								
Expected Results	All test frames are received at their destination UNIs; frames are untagged.								
Verdict	PASS, FAIL, or INCONCLUSIVE								

8.7 CE-VLAN ID Preservation for ENNI Frames With S- and C-tag – All OVC

UNI's CE-VLAN IDs Map to the OVC

ABSTRACT TEST CASES FOR ENNI PHASE 1													
Test Case ID	OVC_ATTRIBUTES.R35.7												
Reference Document Source	MEF 26, R35												
Test Status	Conditional Mandatory												
Requirement	When an OVC has the CE-VLAN ID Preservation attribute with a value of Yes and all of the UNIs with an OVC End Point associated by the OVC are such that all CE-VLAN IDs map to the OVC End Point (see Section 7.5.2 of [MEF 26]), then the relationship between the format of the frame at the ingress External Interface and the corresponding frame at the egress External Interface MUST be as specified in Table 5 of [MEF 26].												
Test Purpose	Verify that ENNI Frames with S- and C-Tags are forwarded to another ENNI. The CE-VLAN ID Preservation attribute has a value of Yes for that OVC and all OVC UNI's CE-VLAN IDs map to that OVC. (Row 7 of Table 5 of [MEF 26])												
Conditions	CE-VLAN ID Preservation = "Yes", Number of ENNI OVC End Points > 1, All OVC UNI's CE-VLAN IDs map to the OVC = "Yes"												
Test Topology/OVC	<p>The diagram illustrates a network topology for testing CE-VLAN ID preservation. It features three Test Systems connected to three External Network Nodes (ENNI1, ENNI2, and UNI7). ENNI1 and ENNI2 are connected to an Operator MEN. UNI7 is connected to OVC35. A red line indicates the connection between UNI7 and OVC35. Tables provide S-VID and End Point ID mappings for ENNI1 and ENNI2, and CE-VID and End Point ID mappings for UNI7.</p> <table border="1" style="display: inline-table; margin-right: 20px;"> <thead> <tr> <th>S-VID</th> <th>End Point ID</th> </tr> </thead> <tbody> <tr> <td>SVID46</td> <td>ENNI1_OVC35_End_Point_1</td> </tr> </tbody> </table> <table border="1" style="display: inline-table; margin-right: 20px;"> <thead> <tr> <th>S-VID</th> <th>End Point ID</th> </tr> </thead> <tbody> <tr> <td>SVID45</td> <td>ENNI2_OVC35_End_Point_1</td> </tr> </tbody> </table> <table border="1" style="display: inline-table;"> <thead> <tr> <th>CE-VID</th> <th>End Point ID</th> </tr> </thead> <tbody> <tr> <td>All</td> <td>UNI7_OVC35_End_Point</td> </tr> </tbody> </table>	S-VID	End Point ID	SVID46	ENNI1_OVC35_End_Point_1	S-VID	End Point ID	SVID45	ENNI2_OVC35_End_Point_1	CE-VID	End Point ID	All	UNI7_OVC35_End_Point
S-VID	End Point ID												
SVID46	ENNI1_OVC35_End_Point_1												
S-VID	End Point ID												
SVID45	ENNI2_OVC35_End_Point_1												
CE-VID	End Point ID												
All	UNI7_OVC35_End_Point												
Test Procedure	Tester transmits double-tagged test frames mapped to OVC35 at ENNI1: CE-VLAN ID is set to values from CVID1 to CVID30, destination MAC addresses are emulated behind ENNI2.												
Expected Results	All test frames are received at ENNI2 or UNI7: ENNI frames are double-tagged, with the original CE-VLAN ID preserved:												
Verdict	PASS, FAIL, or INCONCLUSIVE												

8.8 CE-VLAN ID Preservation for ENNI frames With S-tag Only – All OVC

UNI's CE-VLAN IDs Map to the OVC

ABSTRACT TEST CASES FOR ENNI PHASE 1													
Test Case ID	OVC_ATTRIBUTES.R35.8												
Reference Document Source	MEF 26, R35												
Test Status	Conditional Mandatory												
Requirement	When an OVC has the CE-VLAN ID Preservation attribute with a value of Yes and all of the UNIs with an OVC End Point associated by the OVC are such that all CE-VLAN IDs map to the OVC End Point (see Section 7.5.2 of [MEF 26]), then the relationship between the format of the frame at the ingress External Interface and the corresponding frame at the egress External Interface MUST be as specified in Table 5 of [MEF 26].												
Test Purpose	Verify that the ENNI frames with S-Tag only are forwarded unchanged to the destination ENNI except the S tag, which may change. The CE-VLAN ID Preservation attribute has a value of Yes for that OVC and all OVC UNI's CE-VLAN IDs map to that OVC. (Row 8 of Table 5 of [MEF 26])												
Conditions	CE-VLAN ID Preservation = "Yes", Number of ENNI OVC End Points > 1, All OVC UNI's CE-VLAN IDs map to the OVC = "Yes", Untagged frames at UNI = "Yes"												
Test Topology/OVC	<p>The diagram illustrates a network topology for testing CE-VLAN ID preservation. It features three Test Systems (represented by blue octagons) connected to an Operator MEN. ENNI1 and ENNI2 are connected to the MEN. ENNI1 is connected to OVC35 via ENNI1_OVC35_End_Point_1. ENNI2 is connected to OVC35 via ENNI2_OVC35_End_Point_1. OVC35 is connected to UNI7 via UNI7_OVC35_End_Point. A red line indicates the path from OVC35 to UNI7. Tables provide S-VID, End Point ID, and CE-VID information for each component.</p> <table border="1" style="display: inline-table; margin-right: 20px;"> <thead> <tr> <th>S-VID</th> <th>End Point ID</th> </tr> </thead> <tbody> <tr> <td>SVID46</td> <td>ENNI1_OVC35_End_Point_1</td> </tr> </tbody> </table> <table border="1" style="display: inline-table; margin-right: 20px;"> <thead> <tr> <th>S-VID</th> <th>End Point ID</th> </tr> </thead> <tbody> <tr> <td>SVID45</td> <td>ENNI2_OVC35_End_Point_1</td> </tr> </tbody> </table> <table border="1" style="display: inline-table;"> <thead> <tr> <th>CE-VID</th> <th>End Point ID</th> </tr> </thead> <tbody> <tr> <td>All</td> <td>UNI7_OVC35_End_Point</td> </tr> </tbody> </table>	S-VID	End Point ID	SVID46	ENNI1_OVC35_End_Point_1	S-VID	End Point ID	SVID45	ENNI2_OVC35_End_Point_1	CE-VID	End Point ID	All	UNI7_OVC35_End_Point
S-VID	End Point ID												
SVID46	ENNI1_OVC35_End_Point_1												
S-VID	End Point ID												
SVID45	ENNI2_OVC35_End_Point_1												
CE-VID	End Point ID												
All	UNI7_OVC35_End_Point												
Test Procedure	Tester transmits single S-tagged test frames mapped to OVC35 at ENNI1: destination MAC addresses are emulated behind ENNI2.												
Expected Results	All test frames are received at ENNI2 or UNI7: ENNI frames are single-tagged.												
Verdict	PASS, FAIL, or INCONCLUSIVE												

8.9 CE-VLAN ID Preservation for C-tagged Service Frames – Not All OVC

UNI's CE-VLAN IDs Map to the OVC

ABSTRACT TEST CASES FOR ENNI PHASE 1															
Test Case ID	OVC_ATTRIBUTES.R36.1														
Reference Document Source	MEF 26, R36														
Test Status	Conditional Mandatory														
Requirement	When an OVC has the CE-VLAN ID Preservation attribute with a value of Yes and not all of the UNIs with an OVC End Point associated by the OVC are such that all CE-VLAN IDs map to the OVC End Point (see Section 7.5.2 of [MEF 26]), then the relationships between the format of the frame at the ingress External Interface and the corresponding frame at the egress External Interface MUST be as specified in Table 6 of [MEF 26].														
Test Purpose	Verify that CE-VLAN ID is preserved for Service Frames if CE-VLAN ID Preservation attribute has a value of Yes for that OVC and not all OVC UNI's CE-VLAN IDs map to that OVC. (Rows 1 and 2 of Table 6 of [MEF 26])														
Conditions	CE-VLAN ID Preservation = "Yes", Number of UNI OVC End Points > 1, All OVC UNI's CE-VLAN IDs map to the OVC = "No", Tagged frames at UNI = "Yes"														
Test Topology/OVC	<p>The diagram illustrates a network topology for testing CE-VLAN ID preservation. It features three 'Test System' nodes connected to a central 'OVC6' (Operator MEN). The left system connects via ENNI1 and UNI2. The right system connects via UNI1. The bottom system connects via UNI2. Three tables define the mapping of S-VIDs and CE-VIDs to OVC End Points:</p> <table border="1" style="display: inline-table; margin-right: 20px;"> <thead> <tr> <th>S-VID</th> <th>End Point ID</th> </tr> </thead> <tbody> <tr> <td>SVID8</td> <td>ENNI1_OVC6_End_Point_1</td> </tr> </tbody> </table> <table border="1" style="display: inline-table; margin-right: 20px;"> <thead> <tr> <th>CE-VID</th> <th>End Point ID</th> </tr> </thead> <tbody> <tr> <td>CVID3</td> <td>UNI1_OVC6_End_Point</td> </tr> <tr> <td>CVID4</td> <td>UNI1_OVC6_End_Point</td> </tr> </tbody> </table> <table border="1" style="display: inline-table;"> <thead> <tr> <th>CE-VID</th> <th>End Point ID</th> </tr> </thead> <tbody> <tr> <td>CVID5</td> <td>UNI2_OVC6_End_Point</td> </tr> </tbody> </table>	S-VID	End Point ID	SVID8	ENNI1_OVC6_End_Point_1	CE-VID	End Point ID	CVID3	UNI1_OVC6_End_Point	CVID4	UNI1_OVC6_End_Point	CE-VID	End Point ID	CVID5	UNI2_OVC6_End_Point
S-VID	End Point ID														
SVID8	ENNI1_OVC6_End_Point_1														
CE-VID	End Point ID														
CVID3	UNI1_OVC6_End_Point														
CVID4	UNI1_OVC6_End_Point														
CE-VID	End Point ID														
CVID5	UNI2_OVC6_End_Point														
Test Procedure	Tester transmits C-tagged broadcast test frames at UNI1 that are mapped to OVC6.														
Expected Results	All test frames are received at UNI2, preserving the original CE-VLAN ID. All test frames are received at ENNI1 with the original CE-VLAN ID preserved.														
Verdict	PASS, FAIL, or INCONCLUSIVE														

8.10 CE-VLAN ID Preservation for C-tagged Service Frames – Not All OVC

UNI's CE-VLAN IDs Map to the OVC

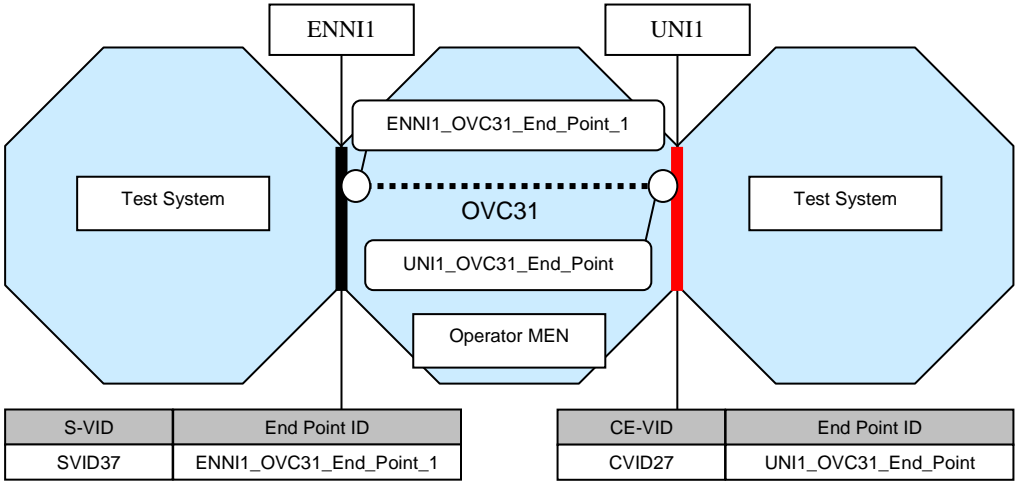
ABSTRACT TEST CASES FOR ENNI PHASE 1									
Test Case ID	OVC_ATTRIBUTES.R36.2								
Reference Document Source	MEF 26, R36								
Test Status	Conditional Mandatory								
Requirement	When an OVC has the CE-VLAN ID Preservation attribute with a value of Yes and not all of the UNIs with an OVC End Point associated by the OVC are such that all CE-VLAN IDs map to the OVC End Point (see Section 7.5.2 of [MEF 26]), then the relationships between the format of the frame at the ingress External Interface and the corresponding frame at the egress External Interface MUST be as specified in Table 6 of [MEF 26].								
Test Purpose	Verify that CE-VLAN ID is preserved if CE-VLAN ID Preservation attribute has a value of Yes for that OVC and not all OVC UNI's CE-VLAN IDs map to that OVC. (Row 2 of Table 6 of [MEF 26], alternative test case for point-to-point OVCs)								
Conditions	CE-VLAN ID Preservation = "Yes", , All OVC UNI's CE-VLAN IDs map to the OVC = "No", Tagged frames at UNI = "Yes"								
Test Topology/OVC	 <table border="1" data-bbox="427 1256 890 1332"> <thead> <tr> <th>S-VID</th> <th>End Point ID</th> </tr> </thead> <tbody> <tr> <td>SVID37</td> <td>ENNI1_OVC31_End_Point_1</td> </tr> </tbody> </table> <table border="1" data-bbox="986 1256 1449 1332"> <thead> <tr> <th>CE-VID</th> <th>End Point ID</th> </tr> </thead> <tbody> <tr> <td>CVID27</td> <td>UNI1_OVC31_End_Point</td> </tr> </tbody> </table>	S-VID	End Point ID	SVID37	ENNI1_OVC31_End_Point_1	CE-VID	End Point ID	CVID27	UNI1_OVC31_End_Point
S-VID	End Point ID								
SVID37	ENNI1_OVC31_End_Point_1								
CE-VID	End Point ID								
CVID27	UNI1_OVC31_End_Point								
Test Procedure	Tester transmits C-tagged test frames at UNI1								
Expected Results	All test frames are received at ENNI1: frames are double-tagged, original CE-VLAN ID is preserved.								
Verdict	PASS, FAIL, or INCONCLUSIVE								

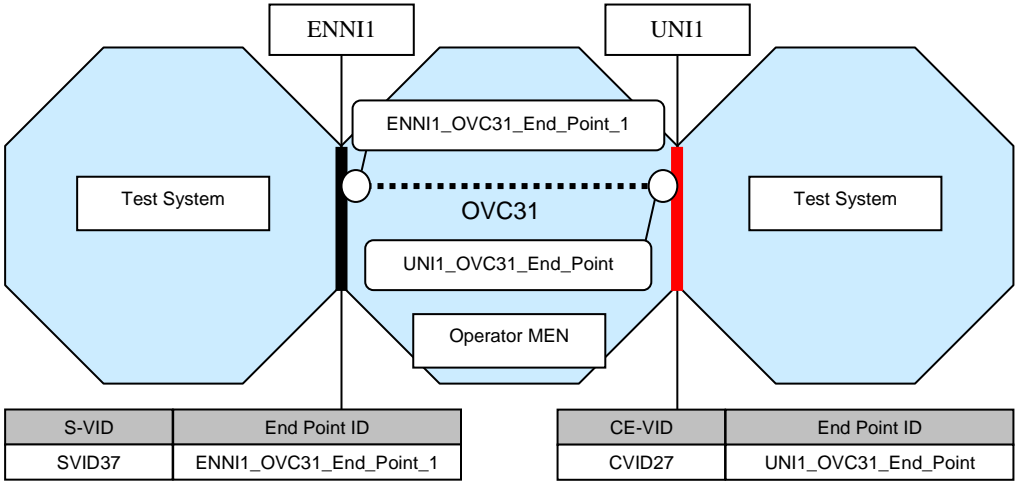

**8.11 CE-VLAN ID Preservation for ENNI Frames – Not All OVC UNI’s CE-VLAN IDs Map to the OVC**

ABSTRACT TEST CASES FOR ENNI PHASE 1									
Test Case ID	OVC_ATTRIBUTES.R36.3								
Reference Document Source	MEF 26, R36								
Test Status	Conditional Mandatory								
Requirement	When an OVC has the CE-VLAN ID Preservation attribute with a value of Yes and not all of the UNIs with an OVC End Point associated by the OVC are such that all CE-VLAN IDs map to the OVC End Point (see Section 7.5.2 of [MEF 26]), then the relationships between the format of the frame at the ingress External Interface and the corresponding frame at the egress External Interface <b>MUST</b> be as specified in Table 6 of [MEF 26].								
Test Purpose	Verify that the ENNI Frames are forwarded to the UNI after the S-Tag was deleted. The CE-VLAN ID Preservation attribute has a value of Yes for that OVC and not all OVC UNI’s CE-VLAN IDs map to that OVC. (Row 3 of Table 6 of [MEF 26])								
Conditions	CE-VLAN ID Preservation = "Yes", , All OVC UNI’s CE-VLAN IDs map to the OVC = "No", Tagged frames at UNI = "Yes"								
Test Topology/OVC	 <table border="1" data-bbox="427 1258 890 1332"> <thead> <tr> <th>S-VID</th> <th>End Point ID</th> </tr> </thead> <tbody> <tr> <td>SVID37</td> <td>ENNI1_OVC31_End_Point_1</td> </tr> </tbody> </table> <table border="1" data-bbox="986 1258 1449 1332"> <thead> <tr> <th>CE-VID</th> <th>End Point ID</th> </tr> </thead> <tbody> <tr> <td>CVID27</td> <td>UNI1_OVC31_End_Point</td> </tr> </tbody> </table>	S-VID	End Point ID	SVID37	ENNI1_OVC31_End_Point_1	CE-VID	End Point ID	CVID27	UNI1_OVC31_End_Point
S-VID	End Point ID								
SVID37	ENNI1_OVC31_End_Point_1								
CE-VID	End Point ID								
CVID27	UNI1_OVC31_End_Point								
Test Procedure	Tester transmits double-tagged test frames at ENNI1 that are mapped to OVC31 with CVID 27, destination MAC addresses are emulated behind UNI1.								
Expected Results	C-Tag test frames are received at UNI1: original CE-VLAN ID is preserved.								
Verdict	PASS, FAIL, or INCONCLUSIVE								

8.12 CE-VLAN ID Preservation for ENNI frames – Not All OVC UNI’s CE-VLAN

IDs Map to the OVC

ABSTRACT TEST CASES FOR ENNI PHASE 1	
Test Case ID	OVC_ATTRIBUTES.R36.4
Reference Document Source	MEF 26, R36
Test Status	Conditional Mandatory
Requirement	When an OVC has the CE-VLAN ID Preservation attribute with a value of Yes and not all of the UNIs with an OVC End Point associated by the OVC are such that all CE-VLAN IDs map to the OVC End Point (see Section 7.5.2 of [MEF 26]), then the relationships between the format of the frame at the ingress External Interface and the corresponding frame at the egress External Interface MUST be as specified in Table 6 of [MEF 26].
Test Purpose	Verify that CE-VLAN ID is preserved for ENNI frames if CE-VLAN ID Preservation attribute has a value of Yes for that OVC and not all OVC UNI’s CE-VLAN IDs map to that OVC. (Row 4 of Table 6 of [MEF 26])
Features	CE-VLAN ID Preservation = "Yes", Number of ENNI OVC End Points > 1, All OVC UNI’s CE-VLAN IDs map to the OVC = "No", Tagged frames at UNI = "Yes"
Test Topology/OVC	<p>The diagram illustrates a network topology for testing CE-VLAN ID preservation. It features three Test Systems (represented by blue octagons) connected to a central OVC36 (Operator MEN). The top-left Test System is connected to ENNI1, which is associated with S-VID SVID3 and End Point ID ENNI1_OVC36_End_Point_1. The top-right Test System is connected to ENNI2, associated with S-VID SVID4 and End Point ID ENNI2_OVC36_End_Point_1. The bottom Test System is connected to UNI1, associated with CE-VID CVID26 and End Point ID UNI1_OVC36_End_Point. A red line indicates the OVC36 connection between ENNI1 and UNI1. A dashed line connects ENNI1 and ENNI2 through the OVC36. Tables within the diagram provide the mapping of S-VIDs, End Point IDs, CE-VIDs, and End Point IDs for each connection.</p>
Test Procedure	Tester transmits double-tagged test frames mapped to OVC36 at ENNI1: with C-VLAN ID is set to values from CVID1 to CVID30, destination MAC addresses are emulated behind ENNI2.
Expected Results	All test frames are received at their destination ENNIs: frames are double-tagged, with original CE-VLAN ID preserved.
Verdict	PASS, FAIL, or INCONCLUSIVE

8.13 CE-VLAN ID Preservation for ENNI frames With C- and S-Tag – OVC

Without UNI End Points

ABSTRACT TEST CASES FOR ENNI PHASE 1									
Test Case ID	OVC_ATTRIBUTES.R37.1								
Reference Document Source	MEF 26, R37								
Test Status	Conditional Mandatory								
Requirement	When an OVC has the CE-VLAN ID Preservation attribute with a value of Yes and none of the End Points associated by the OVC are at UNIs, then the relationships between the format of the frame at the ingress ENNI and the corresponding frame at the egress ENNI MUST be as specified in Table 7 of [MEF 26].								
Test Purpose	Verify that CE-VLAN ID is preserved for double-tagged frames of OVC without End Points at UNIs if CE-VLAN ID Preservation attribute has a value of Yes for that OVC. (Row 1 of Table 7 of [MEF 26])								
Conditions	CE-VLAN ID Preservation = "Yes", Number of UNI OVC End Points = 0, Number of ENNIs > 1								
Test Topology/OVC	<p>The diagram illustrates a test topology for OVC2. It shows two Test Systems connected to ENNI1 and ENNI2. ENNI1 and ENNI2 are connected to OVC2, which is connected to an Operator MEN. Below the diagram are two tables for S-VID and End Point ID.</p> <table border="1"> <thead> <tr> <th>S-VID</th> <th>End Point ID</th> </tr> </thead> <tbody> <tr> <td>SVID2</td> <td>ENNI1_OVC2_End_Point_1</td> </tr> </tbody> </table> <table border="1"> <thead> <tr> <th>S-VID</th> <th>End Point ID</th> </tr> </thead> <tbody> <tr> <td>SVID2</td> <td>ENNI2_OVC2_End_Point_1</td> </tr> </tbody> </table>	S-VID	End Point ID	SVID2	ENNI1_OVC2_End_Point_1	S-VID	End Point ID	SVID2	ENNI2_OVC2_End_Point_1
S-VID	End Point ID								
SVID2	ENNI1_OVC2_End_Point_1								
S-VID	End Point ID								
SVID2	ENNI2_OVC2_End_Point_1								
Test Procedure	Tester transmits double-tagged test frames at ENNI1 that are mapped to OVC2.								
Expected Results	All test frames are received at ENNI2: frames are double-tagged, original CE-VLAN ID is preserved.								
Verdict	PASS, FAIL, or INCONCLUSIVE								

8.14 CE-VLAN ID Preservation for ENNI frames With S-Tag Only – OVC

Without UNI End Points

ABSTRACT TEST CASES FOR ENNI PHASE 1									
Test Case ID	OVC_ATTRIBUTES.R37.2								
Reference Document Source	MEF 26, R37								
Test Status	Conditional Mandatory								
Requirement	When an OVC has the CE-VLAN ID Preservation attribute with a value of Yes and none of the End Points associated by the OVC are at UNIs, then the relationships between the format of the frame at the ingress ENNI and the corresponding frame at the egress ENNI MUST be as specified in Table 7 of [MEF 26].								
Test Purpose	Verify that CE-VLAN ID is preserved for frames without C-tag for an OVC without End Points at UNIs if CE-VLAN ID Preservation attribute has a value of Yes for that OVC. (Row 2 of Table 7 of [MEF 26])								
Conditions	CE-VLAN ID Preservation = "Yes", Number of UNI OVC End Points = 0, Number of ENNIs > 1								
Test Topology/OVC	<table border="1" style="margin-top: 10px;"> <thead> <tr> <th>S-VID</th> <th>End Point ID</th> </tr> </thead> <tbody> <tr> <td>SVID2</td> <td>ENNI1_OVC2_End_Point_1</td> </tr> </tbody> </table> <table border="1" style="margin-top: 10px;"> <thead> <tr> <th>S-VID</th> <th>End Point ID</th> </tr> </thead> <tbody> <tr> <td>SVID2</td> <td>ENNI2_OVC2_End_Point_1</td> </tr> </tbody> </table>	S-VID	End Point ID	SVID2	ENNI1_OVC2_End_Point_1	S-VID	End Point ID	SVID2	ENNI2_OVC2_End_Point_1
S-VID	End Point ID								
SVID2	ENNI1_OVC2_End_Point_1								
S-VID	End Point ID								
SVID2	ENNI2_OVC2_End_Point_1								
Test Procedure	Tester transmits single S-tagged test frames at ENNI1 that are mapped to OVC2.								
Expected Results	test frames are received at ENNI2 single S-tagged.								
Verdict	PASS, FAIL, or INCONCLUSIVE								

9 Test Group: CE-VLAN CoS Preservation

9.1 CE-VLAN CoS Preservation for ENNI Frames

ABSTRACT TEST CASES FOR ENNI PHASE 1	
Test Case ID	OVC_ATTRIBUTES. R38.1
Reference Document Source	MEF 26, R38
Test Status	Conditional Mandatory
Requirement	When an OVC has the CE-VLAN CoS Preservation attribute with a value of Yes the relationship between the format of the frame at the ingress External Interface and the corresponding frame at the egress External Interface MUST be as specified in Table 8 of [MEF 26].
Test Purpose	Verify that the ENNI Frames are forwarded to the UNI with unchanged CE-VLAN CoS field if CE-VLAN CoS preservation is enabled for that OVC. (Row 3 of Table 8 of [MEF 26])
Conditions	CE-VLAN CoS preservation = "Yes", Tagged frames at UNI = "Yes"
Test Topology/OVC	
Test Procedure	Tester transmits double-tagged test frames at ENNI1 that are mapped to OVC34 with CE VLAN CoS set to values from 0 to 7.
Expected Results	All test frames are received at UNI1, mapped to OVC34: frames are C-tagged, each CE VLAN CoS is received unchanged.
Verdict	PASS, FAIL, or INCONCLUSIVE

9.2 CE-VLAN CoS Preservation for C-tagged Service Frames

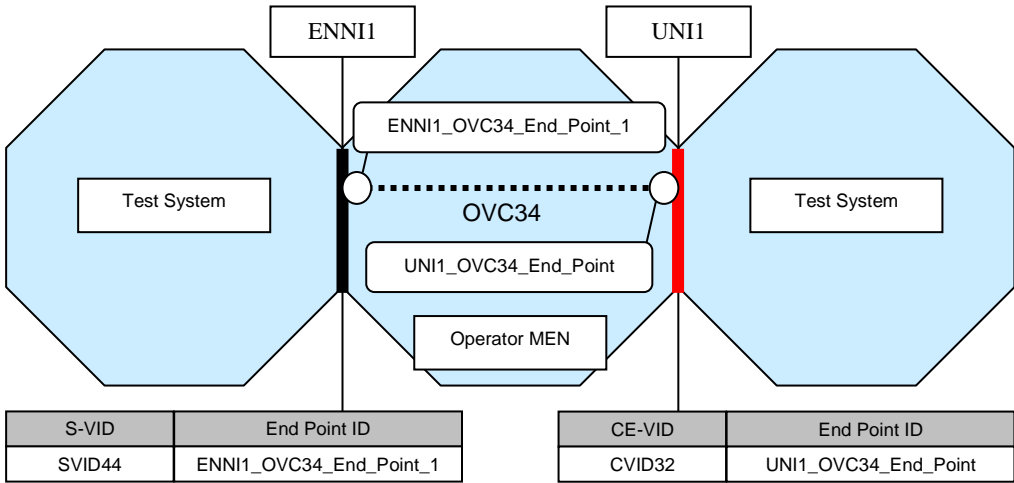
ABSTRACT TEST CASES FOR ENNI PHASE 1									
Test Case ID	OVC_ATTRIBUTES. R38.2								
Reference Document Source	MEF 26, R38								
Test Status	Conditional Mandatory								
Requirement	When an OVC has the CE-VLAN CoS Preservation attribute with a value of Yes the relationship between the format of the frame at the ingress External Interface and the corresponding frame at the egress External Interface MUST be as specified in Table 8 of [MEF 26].								
Test Purpose	Verify that the Service Frames are forwarded to their destination ENNIs with unchanged CE-VLAN CoS field if CE-VLAN CoS preservation is enabled for that OVC. (Row 2 of Table 8 of [MEF 26])								
Conditions	CE-VLAN CoS preservation = "Yes", , Tagged frames at UNI = "Yes"								
Test Topology/OVC	 <table border="1" data-bbox="443 1104 906 1176"> <thead> <tr> <th>S-VID</th> <th>End Point ID</th> </tr> </thead> <tbody> <tr> <td>SVID44</td> <td>ENNI1_OVC34_End_Point_1</td> </tr> </tbody> </table> <table border="1" data-bbox="1002 1104 1461 1176"> <thead> <tr> <th>CE-VID</th> <th>End Point ID</th> </tr> </thead> <tbody> <tr> <td>CVID32</td> <td>UNI1_OVC34_End_Point</td> </tr> </tbody> </table>	S-VID	End Point ID	SVID44	ENNI1_OVC34_End_Point_1	CE-VID	End Point ID	CVID32	UNI1_OVC34_End_Point
S-VID	End Point ID								
SVID44	ENNI1_OVC34_End_Point_1								
CE-VID	End Point ID								
CVID32	UNI1_OVC34_End_Point								
Test Procedure	Tester transmits C-tagged test frames at UNI1 that are mapped to OVC34 with CE VLAN CoS values of 0 to 7.								
Expected Results	All test frames are received at ENNI1, mapped to OVC34: frames are double-tagged, CE-VLAN CoS values are unchanged.								
Verdict	PASS, FAIL, or INCONCLUSIVE								

9.3 CE-VLAN CoS Preservation for C-Tagged Service Frames to UNI

ABSTRACT TEST CASES FOR ENNI PHASE 1															
Test Case ID	OVC_ATTRIBUTES. R38.3														
Reference Document Source	MEF 26, R38														
Test Status	Conditional Mandatory														
Requirement	When an OVC has the CE-VLAN CoS Preservation attribute with a value of Yes the relationship between the format of the frame at the ingress External Interface and the corresponding frame at the egress External Interface MUST be as specified in Table 8 of [MEF 26].														
Test Purpose	Verify that the Service Frames are forwarded to their destination UNIs with unchanged CE-VLAN CoS field if CE-VLAN CoS preservation is enabled for that OVC. (Row 1 of Table 8 of [MEF 26])														
Conditions	CE-VLAN CoS preservation = "Yes", Number of UNI OVC End Points > 1, Tagged frames at UNI = "Yes"														
Test Topology/OVC	<p>The diagram illustrates a network topology for testing CE-VLAN CoS preservation. It features three Test Systems connected to an Operator MEN (Metro Ethernet Network). The network is divided into two segments by a dashed line representing OVC6. On the left, ENNI1 connects to UNI1 and UNI2. On the right, UNI1 and UNI2 connect to the Operator MEN. End Point IDs are mapped to S-VIDs and CE-VIDs. A table below the diagram shows the mapping for CE-VIDs: CVID3 and CVID4 map to UNI1_OVC6_End_Point, and CVID5 maps to UNI2_OVC6_End_Point. A thick red line highlights the path from UNI1 through OVC6 to UNI2.</p> <table border="1" style="margin-left: auto; margin-right: auto;"> <thead> <tr> <th>S-VID</th> <th>End Point ID</th> </tr> </thead> <tbody> <tr> <td>SVID8</td> <td>ENNI1_OVC6_End_Point_1</td> </tr> </tbody> </table> <table border="1" style="margin-left: auto; margin-right: auto;"> <thead> <tr> <th>CE-VID</th> <th>End Point ID</th> </tr> </thead> <tbody> <tr> <td>CVID3</td> <td>UNI1_OVC6_End_Point</td> </tr> <tr> <td>CVID4</td> <td>UNI1_OVC6_End_Point</td> </tr> </tbody> </table> <table border="1" style="margin-left: auto; margin-right: auto;"> <thead> <tr> <th>CE-VID</th> <th>End Point ID</th> </tr> </thead> <tbody> <tr> <td>CVID5</td> <td>UNI2_OVC6_End_Point</td> </tr> </tbody> </table>	S-VID	End Point ID	SVID8	ENNI1_OVC6_End_Point_1	CE-VID	End Point ID	CVID3	UNI1_OVC6_End_Point	CVID4	UNI1_OVC6_End_Point	CE-VID	End Point ID	CVID5	UNI2_OVC6_End_Point
S-VID	End Point ID														
SVID8	ENNI1_OVC6_End_Point_1														
CE-VID	End Point ID														
CVID3	UNI1_OVC6_End_Point														
CVID4	UNI1_OVC6_End_Point														
CE-VID	End Point ID														
CVID5	UNI2_OVC6_End_Point														
Test Procedure	Tester transmits C-tagged broadcast test frames at UNI1 that are mapped to OVC6 with CE VLAN CoS values of 0 to 7.														
Expected Results	All test frames are received at UNI2: CE VLAN CoS values are unchanged. NOTE: Test frames are received at ENNI1. This test is only focused on UNI1 to UNI2 functionality.														
Verdict	PASS, FAIL, or INCONCLUSIVE														

9.4 CE-VLAN CoS Preservation for ENNI frames

ABSTRACT TEST CASES FOR ENNI PHASE 1									
Test Case ID	OVC_ATTRIBUTES. R38.4								
Reference Document Source	MEF 26, R38								
Test Status	Conditional Mandatory								
Requirement	When an OVC has the CE-VLAN CoS Preservation attribute with a value of Yes the relationship between the format of the frame at the ingress External Interface and the corresponding frame at the egress External Interface MUST be as specified in Table 8 of [MEF 26].								
Test Purpose	Verify that the ENNI frames are forwarded to their destination ENNIs with unchanged CE-VLAN CoS field if CE-VLAN CoS preservation is enabled for that OVC. (Row 4 of Table 8 of [MEF 26])								
Conditions	CE-VLAN CoS preservation = "Yes", Number of ENNI OVC End Points > 1								
Test Topology/OVC	<p>The diagram illustrates a test topology for OVC2. It features two Test Systems, each connected to an ENNI (ENNI1 and ENNI2). These ENNIs are connected to a central OVC2 through End Point 1s (ENNI1_OVC2_End_Point_1 and ENNI2_OVC2_End_Point_1). An Operator MEN is also connected to OVC2. Below the diagram are two tables for S-VID and End Point ID.</p> <table border="1" style="display: inline-table; margin-right: 20px;"> <thead> <tr> <th>S-VID</th> <th>End Point ID</th> </tr> </thead> <tbody> <tr> <td>SVID2</td> <td>ENNI1_OVC2_End_Point_1</td> </tr> </tbody> </table> <table border="1" style="display: inline-table;"> <thead> <tr> <th>S-VID</th> <th>End Point ID</th> </tr> </thead> <tbody> <tr> <td>SVID2</td> <td>ENNI2_OVC2_End_Point_1</td> </tr> </tbody> </table>	S-VID	End Point ID	SVID2	ENNI1_OVC2_End_Point_1	S-VID	End Point ID	SVID2	ENNI2_OVC2_End_Point_1
S-VID	End Point ID								
SVID2	ENNI1_OVC2_End_Point_1								
S-VID	End Point ID								
SVID2	ENNI2_OVC2_End_Point_1								
Test Procedure	Tester transmits double-tagged test frames at ENNI1 that are mapped to OVC2 with CE VLAN CoS values of 0 to 7.								
Expected Results	All test frames are received at ENNI2: frames are double-tagged with CE-VLAN CoS values unchanged.								
Verdict	PASS, FAIL, or INCONCLUSIVE								

10 Test Group: Color Forwarding



10.1 Yellow Color Declaration by UNI Ingress BWP, ENNI Yellow Color

Indication by S-VLAN PCP

ABSTRACT TEST CASES FOR ENNI PHASE 1									
Test Case ID	COLOR_FORWARDING. R43.1								
Reference Document Source	MEF 26, R43								
Test Status	Conditional Mandatory								
Requirement	<p>When the Color Forwarding attribute is Yes for an OVC, each egress ENNI Frame mapped to an OVC End Point that is associated by the OVC MUST be marked Yellow using one of the formats specified in Section 7.3.2 of [MEF 26] if the corresponding ingress frame into the Operator MEN satisfied one or more of the following:</p> <ul style="list-style-type: none"> <li>The corresponding ingress frame was a Service Frame that was declared Yellow by an Ingress Bandwidth Profile and the Service Frame was mapped to an OVC End Point at the UNI that is associated by the OVC,</li> <li>The corresponding ingress frame was a Service Frame with a frame header indicating Yellow as specified in MEF 23 [MEF 23] and the Service Frame was mapped to an OVC End Point at the UNI that is associated by the OVC,</li> <li>The corresponding ingress frame was an ENNI Frame that was declared Yellow by an Ingress Bandwidth Profile and the ENNI Frame was mapped to an OVC End Point at the ENNI that is associated by the OVC,</li> <li>The corresponding ingress frame was an ENNI Frame with a frame header indicating Yellow using one of the formats specified in Section 7.3.2 of [MEF 26] and the ENNI Frame was mapped to an OVC End Point at the ENNI that is associated by the OVC.</li> </ul>								
Test Purpose	<p>Verify that each egress ENNI Frame is marked Yellow, if the following conditions are fulfilled:</p> <ul style="list-style-type: none"> <li>The egress ENNI Frames are mapped to a UNI OVC End Point associated by an OVC,</li> <li>The egress ENNI Frames were previously declared Yellow by an Ingress Bandwidth Profile associated with that OVC at UNI</li> <li>The Color Forwarding is enabled for that OVC</li> <li>S-Tag PCP color indication is enabled at egress ENNI for the OVC</li> </ul>								
Conditions	<p>Color Forwarding = "Yes",                      S-Tag PCP Color Indication = "Yes",                      Ingress Bandwidth profile per Class of Service Identifier at UNI = "Yes"</p>								
Test Topology/OVC	<p>The diagram illustrates a network topology for testing. It features two 'Test System' blocks connected to a central 'Operator MEN' block. The 'Operator MEN' is connected to 'ENNI1' and 'UNI1'. 'ENNI1' is connected to 'ENNI1_OVC26_End_Point_1', and 'UNI1' is connected to 'UNI1_OVC26_End_Point'. Both end points are connected to 'OVC26'. Below the diagram are two tables:</p> <table border="1"> <thead> <tr> <th>S-VID</th> <th>End Point ID</th> </tr> </thead> <tbody> <tr> <td>SVID30</td> <td>ENNI1_OVC26_End_Point_1</td> </tr> </tbody> </table> <table border="1"> <thead> <tr> <th>CE-VID</th> <th>End Point ID</th> </tr> </thead> <tbody> <tr> <td>CVID23</td> <td>UNI1_OVC26_End_Point</td> </tr> </tbody> </table>	S-VID	End Point ID	SVID30	ENNI1_OVC26_End_Point_1	CE-VID	End Point ID	CVID23	UNI1_OVC26_End_Point
S-VID	End Point ID								
SVID30	ENNI1_OVC26_End_Point_1								
CE-VID	End Point ID								
CVID23	UNI1_OVC26_End_Point								
Test Procedure	<p>Tester transmits test frames mapped to OVC26 at UNI1 per CoS: the information rate is set to <math>(1.0 - \text{ToleranceFactor}) * \text{CIR1} + 0.5 * \text{EIR1}</math>, the CoS ID of all frames is set to UNI_Green_CoS1_IDs.</p>								
Expected Results	<p>Test frames are received at ENNI1: CoS ID is set to ENNI_Green_CoS1_IDs, information rate is at least <math>(1.0 - \text{ToleranceFactor}) * \text{CIR1}</math>.</p>								

	Larger than zero test frames are received at ENNI1: CoS ID is set to ENNI_Yellow_PCP_CoS1_IDs, information rate is $0.5 * EIR1$ . or less
Verdict	PASS, FAIL, or INCONCLUSIVE

10.2 Yellow Color Declaration by UNI Ingress BWP, ENNI Yellow Color

Indication by S-VLAN DEI

ABSTRACT TEST CASES FOR ENNI PHASE 1									
Test Case ID	COLOR_FORWARDING. R43.2								
Reference Document Source	MEF 26, R43								
Test Status	Conditional Mandatory								
Requirement	<p>When the Color Forwarding attribute is Yes for an OVC, each egress ENNI Frame mapped to an OVC End Point that is associated by the OVC MUST be marked Yellow using one of the formats specified in Section 7.3.2 of [MEF 26] if the corresponding ingress frame into the Operator MEN satisfied one or more of the following:</p> <ul style="list-style-type: none"> <li>The corresponding ingress frame was a Service Frame that was declared Yellow by an Ingress Bandwidth Profile and the Service Frame was mapped to an OVC End Point at the UNI that is associated by the OVC,</li> <li>The corresponding ingress frame was a Service Frame with a frame header indicating Yellow as specified in MEF 23 [MEF 23] and the Service Frame was mapped to an OVC End Point at the UNI that is associated by the OVC,</li> <li>The corresponding ingress frame was an ENNI Frame that was declared Yellow by an Ingress Bandwidth Profile and the ENNI Frame was mapped to an OVC End Point at the ENNI that is associated by the OVC,</li> <li>The corresponding ingress frame was an ENNI Frame with a frame header indicating Yellow using one of the formats specified in Section 7.3.2 of [MEF 26] and the ENNI Frame was mapped to an OVC End Point at the ENNI that is associated by the OVC.</li> </ul>								
Test Purpose	<p>Verify that each egress ENNI Frame is marked Yellow, if the following conditions are fulfilled:</p> <ul style="list-style-type: none"> <li>The egress ENNI Frames were mapped to an UNI OVC End Point associated by an OVC,</li> <li>The egress ENNI Frames were previously declared Yellow by the OVC Ingress Bandwidth Profile at UNI</li> <li>The Color Forwarding and S-Tag DEI color indication are enabled at egress ENNI for the OVC</li> </ul>								
Conditions	<p>Color Forwarding = "Yes",                      DEI Color Indication = "Yes",                      Ingress Bandwidth profile per Class of Service Identifier at UNI = "Yes"</p>								
Test Topology/OVC	<table border="1" style="width: 100%; margin-top: 10px;"> <tr> <td style="width: 50%;">S-VID</td> <td style="width: 50%;">End Point ID</td> <td style="width: 50%;">CE-VID</td> <td style="width: 50%;">End Point ID</td> </tr> <tr> <td>SVID30</td> <td>ENNI1_OVC26_End_Point_1</td> <td>CVID23</td> <td>UNI1_OVC26_End_Point</td> </tr> </table>	S-VID	End Point ID	CE-VID	End Point ID	SVID30	ENNI1_OVC26_End_Point_1	CVID23	UNI1_OVC26_End_Point
S-VID	End Point ID	CE-VID	End Point ID						
SVID30	ENNI1_OVC26_End_Point_1	CVID23	UNI1_OVC26_End_Point						
Test Procedure	<p>Tester transmits test frames mapped to OVC26 at UNI1 per CoS: the information rate is set to <math>(1.0 - \text{ToleranceFactor}) * \text{CIR1} + 0.5 * \text{EIR1}</math>, the CoS ID of all frames is set to UNI_Green_CoS1_IDs..</p>								
Expected Results	<p>Test frames are received at ENNI1: CoS ID is set to ENNI_Green_CoS1_IDs, information</p>								

	rate is at least $(1.0 - \text{ToleranceFactor}) * \text{CIR1}$ . More than zero test frames are received at ENNI1: CoS ID is set to ENNI_Yellow_DEI_CoS1_IDs, information rate is $0.5 * \text{EIR1}$ or less.
Verdict	PASS, FAIL, or INCONCLUSIVE

10.3 Yellow Ingress Frames at UNI, ENNI Yellow Color Indication by S-VLAN

PCP

ABSTRACT TEST CASES FOR ENNI PHASE 1									
Test Case ID	COLOR_FORWARDING. R43.3								
Reference Document Source	MEF 26, R43								
Test Status	Conditional Mandatory								
Requirement	<p>When the Color Forwarding attribute is Yes for an OVC, each egress ENNI Frame mapped to an OVC End Point that is associated by the OVC MUST be marked Yellow using one of the formats specified in Section 7.3.2 of [MEF 26] if the corresponding ingress frame into the Operator MEN satisfied one or more of the following:</p> <ul style="list-style-type: none"> <li>The corresponding ingress frame was a Service Frame that was declared Yellow by an Ingress Bandwidth Profile and the Service Frame was mapped to an OVC End Point at the UNI that is associated by the OVC,</li> <li>The corresponding ingress frame was a Service Frame with a frame header indicating Yellow as specified in MEF 23 [MEF 23] and the Service Frame was mapped to an OVC End Point at the UNI that is associated by the OVC,</li> <li>The corresponding ingress frame was an ENNI Frame that was declared Yellow by an Ingress Bandwidth Profile and the ENNI Frame was mapped to an OVC End Point at the ENNI that is associated by the OVC,</li> <li>The corresponding ingress frame was an ENNI Frame with a frame header indicating Yellow using one of the formats specified in Section 7.3.2 of [MEF 26] and the ENNI Frame was mapped to an OVC End Point at the ENNI that is associated by the OVC.</li> </ul>								
Test Purpose	<p>Verify that each egress ENNI Frame is marked Yellow, if the following conditions are fulfilled:</p> <ul style="list-style-type: none"> <li>The egress ENNI Frames were mapped to an UNI OVC End Point associated by an OVC,</li> <li>The egress ENNI Frames were previously indicated Yellow at the ingress UNI</li> <li>The Color Forwarding and S-Tag PCP color indication are enabled at egress ENNI for the OVC</li> </ul>								
Conditions	<p>Color Forwarding = "Yes",                      S-Tag PCP Color Indication = "Yes",                      Ingress Bandwidth profile per Class of Service Identifier at UNI = "Yes"</p>								
Test Topology/OVC	<table border="1" style="width: 100%; margin-top: 10px;"> <tr> <td style="width: 50%; text-align: center;">S-VID</td> <td style="width: 50%; text-align: center;">End Point ID</td> </tr> <tr> <td style="text-align: center;">SVID30</td> <td style="text-align: center;">ENNI1_OVC26_End_Point_1</td> </tr> </table> <table border="1" style="width: 100%; margin-top: 10px;"> <tr> <td style="width: 50%; text-align: center;">CE-VID</td> <td style="width: 50%; text-align: center;">End Point ID</td> </tr> <tr> <td style="text-align: center;">CVID23</td> <td style="text-align: center;">UNI1_OVC26_End_Point</td> </tr> </table>	S-VID	End Point ID	SVID30	ENNI1_OVC26_End_Point_1	CE-VID	End Point ID	CVID23	UNI1_OVC26_End_Point
S-VID	End Point ID								
SVID30	ENNI1_OVC26_End_Point_1								
CE-VID	End Point ID								
CVID23	UNI1_OVC26_End_Point								
Test Procedure	Tester transmits test frames mapped to OVC26 at UNI1 per CoS: the information rate is set to 0.5*EIR1, the CoS ID is set to UNI_Yellow_CoS1_IDs								
Expected Results	All test frames are received at ENNI1: CoS ID is set to ENNI_Yellow_PCP_CoS1_IDs.								
Verdict	PASS, FAIL, or INCONCLUSIVE								

10.4 Yellow Ingress Frames at UNI, ENNI Yellow Color Indication by S-VLAN

DEI

ABSTRACT TEST CASES FOR ENNI PHASE 1									
Test Case ID	COLOR_FORWARDING. R43.4								
Reference Document Source	MEF 26, R43								
Test Status	Conditional Mandatory								
Requirement	<p>When the Color Forwarding attribute is Yes for an OVC, each egress ENNI Frame mapped to an OVC End Point that is associated by the OVC MUST be marked Yellow using one of the formats specified in Section 7.3.2 of [MEF 26] if the corresponding ingress frame into the Operator MEN satisfied one or more of the following:</p> <ul style="list-style-type: none"> <li>The corresponding ingress frame was a Service Frame that was declared Yellow by an Ingress Bandwidth Profile and the Service Frame was mapped to an OVC End Point at the UNI that is associated by the OVC,</li> <li>The corresponding ingress frame was a Service Frame with a frame header indicating Yellow as specified in MEF 23 [MEF 23] and the Service Frame was mapped to an OVC End Point at the UNI that is associated by the OVC,</li> <li>The corresponding ingress frame was an ENNI Frame that was declared Yellow by an Ingress Bandwidth Profile and the ENNI Frame was mapped to an OVC End Point at the ENNI that is associated by the OVC,</li> <li>The corresponding ingress frame was an ENNI Frame with a frame header indicating Yellow using one of the formats specified in Section 7.3.2 of [MEF 26] and the ENNI Frame was mapped to an OVC End Point at the ENNI that is associated by the OVC.</li> </ul>								
Test Purpose	<p>Verify that each egress ENNI Frame is marked Yellow, if the following conditions are fulfilled:</p> <ul style="list-style-type: none"> <li>The egress ENNI Frames were mapped to an UNI OVC End Point associated by an OVC,</li> <li>The egress ENNI Frames were previously indicated Yellow at the ingress UNI</li> <li>The Color Forwarding and S-Tag DEI color indication are enabled at egress ENNI for the OVC</li> </ul>								
Conditions	<p>Color Forwarding = "Yes",                      DEI Color Indication = "Yes",                      Ingress Bandwidth profile per Class of Service Identifier at UNI = "Yes"</p>								
Test Topology/OVC	<table border="1" style="margin-top: 10px;"> <tr> <td>S-VID</td> <td>End Point ID</td> </tr> <tr> <td>SVID30</td> <td>ENNI1_OVC26_End_Point_1</td> </tr> </table> <table border="1" style="margin-top: 10px;"> <tr> <td>CE-VID</td> <td>End Point ID</td> </tr> <tr> <td>CVID23</td> <td>UNI1_OVC26_End_Point</td> </tr> </table>	S-VID	End Point ID	SVID30	ENNI1_OVC26_End_Point_1	CE-VID	End Point ID	CVID23	UNI1_OVC26_End_Point
S-VID	End Point ID								
SVID30	ENNI1_OVC26_End_Point_1								
CE-VID	End Point ID								
CVID23	UNI1_OVC26_End_Point								
Test Procedure	Tester transmits test frames mapped to OVC26 at UNI1 per CoS: the information rate is set to 0.5*EIR1, the CoS ID is set to UNI_Yellow_CoS1_IDs.								
Expected Results	All test frames are received at ENNI1: CoS ID is set to ENNI_Yellow_DEI_CoS1_IDs.								
Verdict	PASS, FAIL, or INCONCLUSIVE								

**10.5 Yellow Color Declaration by ENNI Ingress BWP, ENNI Yellow Color Indication by S-VLAN PCP**

ABSTRACT TEST CASES FOR ENNI PHASE 1									
Test Case ID	COLOR_FORWARDING. R43.5								
Reference Document Source	MEF 26, R43								
Test Status	Conditional Mandatory								
Requirement	<p>When the Color Forwarding attribute is Yes for an OVC, each egress ENNI Frame mapped to an OVC End Point that is associated by the OVC MUST be marked Yellow using one of the formats specified in Section 7.3.2 of [MEF 26] if the corresponding ingress frame into the Operator MEN satisfied one or more of the following:</p> <ul style="list-style-type: none"> <li>The corresponding ingress frame was a Service Frame that was declared Yellow by an Ingress Bandwidth Profile and the Service Frame was mapped to an OVC End Point at the UNI that is associated by the OVC,</li> <li>The corresponding ingress frame was a Service Frame with a frame header indicating Yellow as specified in MEF 23 [MEF 23] and the Service Frame was mapped to an OVC End Point at the UNI that is associated by the OVC,</li> <li>The corresponding ingress frame was an ENNI Frame that was declared Yellow by an Ingress Bandwidth Profile and the ENNI Frame was mapped to an OVC End Point at the ENNI that is associated by the OVC,</li> <li>The corresponding ingress frame was an ENNI Frame with a frame header indicating Yellow using one of the formats specified in Section 7.3.2 of [MEF 26] and the ENNI Frame was mapped to an OVC End Point at the ENNI that is associated by the OVC.</li> </ul>								
Test Purpose	<p>Verify that each egress ENNI Frame is marked Yellow, if the following conditions are fulfilled:</p> <ul style="list-style-type: none"> <li>The egress ENNI Frames were mapped to an ENNI OVC End Point associated by an OVC,</li> <li>The egress ENNI Frames were previously declared Yellow by the OVC Ingress Bandwidth Profile at ENNI</li> <li>The Color Forwarding and S-Tag PCP color indication are enabled at egress ENNI for the OVC</li> </ul>								
Conditions	<p>Number of ENNI OVC End Points &gt; 1,            Color Forwarding = "Yes",            ENNI1: S-Tag PCP Color Indication = "Yes",            ENNI2: Ingress Bandwidth profile perClass of Service Identifier at ENNI = "Yes"</p>								
Test Topology/OVC	<table border="1" style="width: 100%; text-align: center;"> <tr> <td>S-VID</td> <td>End Point ID</td> <td>S-VID</td> <td>End Point ID</td> </tr> <tr> <td>SVID32</td> <td>ENNI1_OVC28_End_Point_1</td> <td>SVID33</td> <td>ENNI2_OVC28_End_Point_1</td> </tr> </table>	S-VID	End Point ID	S-VID	End Point ID	SVID32	ENNI1_OVC28_End_Point_1	SVID33	ENNI2_OVC28_End_Point_1
S-VID	End Point ID	S-VID	End Point ID						
SVID32	ENNI1_OVC28_End_Point_1	SVID33	ENNI2_OVC28_End_Point_1						
Test Procedure	<p>Tester transmits test frames mapped to OVC28 at ENNI2 per CoS: the information rate is set to <math>(10 - \text{ToleranceFactor}) * \text{CIR}1 + 0.5 * \text{EIR}1</math>, the CoS ID of all frames is set to ENNI_Green_CoS1_IDs.</p>								
Expected Results	<p>Test frames are received at ENNI1: CoS ID is set to ENNI_Green_CoS1_IDs, information</p>								

	rate is at least $(1.0 - \text{ToleranceFactor}) * \text{CIR1}$ . More than zero test frames are received at ENNI1: CoS ID is set to ENNI_Yellow_PCP_CoS1_IDs, information rate is $0.5 * \text{EIR1}$ or less.
Verdict	PASS, FAIL, or INCONCLUSIVE



### 10.6 Yellow Color Declaration by ENNI Ingress BWP, ENNI Yellow Color Indication by S-VLAN DEI

ABSTRACT TEST CASES FOR ENNI PHASE 1									
Test Case ID	COLOR_FORWARDING. R43.6								
Reference Document Source	MEF 26, R43								
Test Status	Conditional Mandatory								
Requirement	<p>When the Color Forwarding attribute is Yes for an OVC, each egress ENNI Frame mapped to an OVC End Point that is associated by the OVC MUST be marked Yellow using one of the formats specified in Section 7.3.2 of [MEF 26] if the corresponding ingress frame into the Operator MEN satisfied one or more of the following:</p> <ul style="list-style-type: none"> <li>The corresponding ingress frame was a Service Frame that was declared Yellow by an Ingress Bandwidth Profile and the Service Frame was mapped to an OVC End Point at the UNI that is associated by the OVC,</li> <li>The corresponding ingress frame was a Service Frame with a frame header indicating Yellow as specified in MEF 23 [MEF 23] and the Service Frame was mapped to an OVC End Point at the UNI that is associated by the OVC,</li> <li>The corresponding ingress frame was an ENNI Frame that was declared Yellow by an Ingress Bandwidth Profile and the ENNI Frame was mapped to an OVC End Point at the ENNI that is associated by the OVC,</li> <li>The corresponding ingress frame was an ENNI Frame with a frame header indicating Yellow using one of the formats specified in Section 7.3.2 of [MEF 26] and the ENNI Frame was mapped to an OVC End Point at the ENNI that is associated by the OVC.</li> </ul>								
Test Purpose	<p>Verify that each egress ENNI Frame is marked Yellow, if the following conditions are fulfilled:</p> <ul style="list-style-type: none"> <li>The egress ENNI Frames were mapped to an ENNI OVC End Point associated by an OVC,</li> <li>The egress ENNI Frames were previously declared Yellow by the OVC Ingress Bandwidth Profile at ENNI</li> <li>The Color Forwarding and the S-Tag DEI color indication are enabled at the egress ENNI for the OVC</li> </ul>								
Conditions	<p>Number of ENNI OVC End Points &gt; 1,            Color Forwarding = "Yes",            ENNI1: DEI Color Indication = "Yes",            ENNI2: Ingress Bandwidth profile per Class of Service Identifier at ENNI = "Yes"</p>								
Test Topology/OVC	<table border="1" style="margin-top: 10px;"> <thead> <tr> <th>S-VID</th> <th>End Point ID</th> </tr> </thead> <tbody> <tr> <td>SVID32</td> <td>ENNI1_OVC28_End_Point_1</td> </tr> </tbody> </table> <table border="1" style="margin-top: 10px;"> <thead> <tr> <th>S-VID</th> <th>End Point ID</th> </tr> </thead> <tbody> <tr> <td>SVID33</td> <td>ENNI2_OVC28_End_Point_1</td> </tr> </tbody> </table>	S-VID	End Point ID	SVID32	ENNI1_OVC28_End_Point_1	S-VID	End Point ID	SVID33	ENNI2_OVC28_End_Point_1
S-VID	End Point ID								
SVID32	ENNI1_OVC28_End_Point_1								
S-VID	End Point ID								
SVID33	ENNI2_OVC28_End_Point_1								
Test Procedure	Tester transmits test frames mapped to OVC28 at ENNI2 per CoS: the information rate is set to $(1.0 - \text{ToleranceFactor}) * \text{CIR1} + 0.5 * \text{EIR1}$ , the CoS ID is set to ENNI_Green_CoS1_IDs.								
Expected Results	Test frames are received at ENNI1: CoS ID is set to ENNI_Green_CoS1_IDs, information rate is at least $(1.0 - \text{ToleranceFactor}) * \text{CIR1}$ .								

	More than zero test frames are received at ENNI1: CoS ID is set to ENNI_Yellow_DEI_CoS1_IDs, information rate is 0.5 * EIR1 or less.
Verdict	PASS, FAIL, or INCONCLUSIVE

### 10.7 Yellow Ingress Frames at ENNI, Yellow Color Indication by S-VLAN PCP at Ingress and Egress ENNI

ABSTRACT TEST CASES FOR ENNI PHASE 1									
Test Case ID	COLOR_FORWARDING. R43.6								
Reference Document Source	MEF 26, R43								
Test Status	Conditional Mandatory								
Requirement	<p>When the Color Forwarding attribute is Yes for an OVC, each egress ENNI Frame mapped to an OVC End Point that is associated by the OVC MUST be marked Yellow using one of the formats specified in Section 7.3.2 of [MEF 26] if the corresponding ingress frame into the Operator MEN satisfied one or more of the following:</p> <ul style="list-style-type: none"> <li>The corresponding ingress frame was a Service Frame that was declared Yellow by an Ingress Bandwidth Profile and the Service Frame was mapped to an OVC End Point at the UNI that is associated by the OVC,</li> <li>The corresponding ingress frame was a Service Frame with a frame header indicating Yellow as specified in MEF 23 [MEF 23] and the Service Frame was mapped to an OVC End Point at the UNI that is associated by the OVC,</li> <li>The corresponding ingress frame was an ENNI Frame that was declared Yellow by an Ingress Bandwidth Profile and the ENNI Frame was mapped to an OVC End Point at the ENNI that is associated by the OVC,</li> <li>The corresponding ingress frame was an ENNI Frame with a frame header indicating Yellow using one of the formats specified in Section 7.3.2 of [MEF 26] and the ENNI Frame was mapped to an OVC End Point at the ENNI that is associated by the OVC.</li> </ul>								
Test Purpose	<p>Verify that each egress ENNI Frame is marked Yellow, if the following conditions are fulfilled:</p> <ul style="list-style-type: none"> <li>The egress ENNI Frames were mapped to an ENNI OVC End Point associated by an OVC,</li> <li>The egress ENNI Frames were previously indicated Yellow at the ingress ENNI</li> <li>The Color Forwarding and the S-Tag PCP color indication are enabled at the ingress and egress ENNIs for the OVC</li> </ul>								
Conditions	<p>Number of ENNI OVC End Points &gt; 1,            Color Forwarding = "Yes",            ENNI1 &amp; ENNI2: S-Tag PCP Color Indication = "Yes",            ENNI2: Ingress Bandwidth profile per Class of Service Identifier at ENNI = "Yes"</p>								
Test Topology/OVC	<p>The diagram illustrates a test topology for an OVC. Two Test Systems are connected to ENNI1 and ENNI2. ENNI1 and ENNI2 are connected to an OVC28. The OVC28 has two End Points: ENNI1_OVC28_End_Point_1 and ENNI2_OVC28_End_Point_1. Below the diagram are two tables for S-VID and End Point ID.</p> <table border="1"> <thead> <tr> <th>S-VID</th> <th>End Point ID</th> </tr> </thead> <tbody> <tr> <td>SVID32</td> <td>ENNI1_OVC28_End_Point_1</td> </tr> </tbody> </table> <table border="1"> <thead> <tr> <th>S-VID</th> <th>End Point ID</th> </tr> </thead> <tbody> <tr> <td>SVID33</td> <td>ENNI2_OVC28_End_Point_1</td> </tr> </tbody> </table>	S-VID	End Point ID	SVID32	ENNI1_OVC28_End_Point_1	S-VID	End Point ID	SVID33	ENNI2_OVC28_End_Point_1
S-VID	End Point ID								
SVID32	ENNI1_OVC28_End_Point_1								
S-VID	End Point ID								
SVID33	ENNI2_OVC28_End_Point_1								
Test Procedure	Tester transmits test frames mapped to OVC28 at ENNI2 per CoS: the information rate is set to 0.5*EIR1, the CoS ID is set to ENNI_Yellow_PCP_CoS1_IDs.								
Expected Results	All test frames are received at ENNI1: CoS ID is set to ENNI_Yellow_PCP_CoS1_IDs.								
Verdict	PASS, FAIL, or INCONCLUSIVE								

### 10.8 Yellow Ingress Frames at ENNI, Yellow Color Indication by S-VLAN DEI at Ingress and Egress ENNI

ABSTRACT TEST CASES FOR ENNI PHASE 1									
Test Case ID	COLOR_FORWARDING. R43.6								
Reference Document Source	MEF 26, R43								
Test Status	Conditional Mandatory								
Requirement	<p>When the Color Forwarding attribute is Yes for an OVC, each egress ENNI Frame mapped to an OVC End Point that is associated by the OVC MUST be marked Yellow using one of the formats specified in Section 7.3.2 of [MEF 26] if the corresponding ingress frame into the Operator MEN satisfied one or more of the following:</p> <ul style="list-style-type: none"> <li>The corresponding ingress frame was a Service Frame that was declared Yellow by an Ingress Bandwidth Profile and the Service Frame was mapped to an OVC End Point at the UNI that is associated by the OVC,</li> <li>The corresponding ingress frame was a Service Frame with a frame header indicating Yellow as specified in MEF 23 [MEF 23] and the Service Frame was mapped to an OVC End Point at the UNI that is associated by the OVC,</li> <li>The corresponding ingress frame was an ENNI Frame that was declared Yellow by an Ingress Bandwidth Profile and the ENNI Frame was mapped to an OVC End Point at the ENNI that is associated by the OVC,</li> <li>The corresponding ingress frame was an ENNI Frame with a frame header indicating Yellow using one of the formats specified in Section 7.3.2 of [MEF 26] and the ENNI Frame was mapped to an OVC End Point at the ENNI that is associated by the OVC.</li> </ul>								
Test Purpose	<p>Verify that each egress ENNI Frame is marked Yellow, if the following conditions are fulfilled:</p> <ul style="list-style-type: none"> <li>The egress ENNI Frames were mapped to an ENNI OVC End Point associated by an OVC,</li> <li>The egress ENNI Frames were previously indicated Yellow at the ingress ENNI</li> <li>The Color Forwarding and the S-Tag DEI color indication are enabled at the ingress and egress ENNIs for the OVC</li> </ul>								
Conditions	<p>Number of ENNI OVC End Points &gt; 1,            Color Forwarding = "Yes",            ENNI1 &amp; ENNI2: DEI Color Indication = "Yes",            ENNI2: Ingress Bandwidth profile per Class of Service Identifier at ENNI = "Yes"</p>								
Test Topology/OVC	<table border="1" style="width: 100%; text-align: center;"> <tr> <td>S-VID</td> <td>End Point ID</td> <td>S-VID</td> <td>End Point ID</td> </tr> <tr> <td>SVID32</td> <td>ENNI1_OVC28_End_Point_1</td> <td>SVID33</td> <td>ENNI2_OVC28_End_Point_1</td> </tr> </table>	S-VID	End Point ID	S-VID	End Point ID	SVID32	ENNI1_OVC28_End_Point_1	SVID33	ENNI2_OVC28_End_Point_1
S-VID	End Point ID	S-VID	End Point ID						
SVID32	ENNI1_OVC28_End_Point_1	SVID33	ENNI2_OVC28_End_Point_1						
Test Procedure	Tester transmits test frames mapped to OVC28 at ENNI2 per CoS: the information rate is set to 0.5*EIR1, the CoS ID is set to ENNI_Yellow_DEI_CoS1_IDs.								
Expected Results	All test frames are received at ENNI1: CoS ID is set to ENNI_Yellow_DEI_CoS1_IDs.								
Verdict	PASS, FAIL, or INCONCLUSIVE								

### 10.9 Yellow Ingress Frames at ENNI, Yellow Color Indication by S-VLAN PCP at Ingress and by S-VLAN DEI at Egress ENNI

ABSTRACT TEST CASES FOR ENNI PHASE 1									
Test Case ID	COLOR_FORWARDING. R43.6								
Reference Document Source	MEF 26, R43								
Test Status	Conditional Mandatory								
Requirement	<p>When the Color Forwarding attribute is Yes for an OVC, each egress ENNI Frame mapped to an OVC End Point that is associated by the OVC MUST be marked Yellow using one of the formats specified in Section 7.3.2 of [MEF 26] if the corresponding ingress frame into the Operator MEN satisfied one or more of the following:</p> <ul style="list-style-type: none"> <li>The corresponding ingress frame was a Service Frame that was declared Yellow by an Ingress Bandwidth Profile and the Service Frame was mapped to an OVC End Point at the UNI that is associated by the OVC,</li> <li>The corresponding ingress frame was a Service Frame with a frame header indicating Yellow as specified in MEF 23 [MEF 23] and the Service Frame was mapped to an OVC End Point at the UNI that is associated by the OVC,</li> <li>The corresponding ingress frame was an ENNI Frame that was declared Yellow by an Ingress Bandwidth Profile and the ENNI Frame was mapped to an OVC End Point at the ENNI that is associated by the OVC,</li> <li>The corresponding ingress frame was an ENNI Frame with a frame header indicating Yellow using one of the formats specified in Section 7.3.2 of [MEF 26] and the ENNI Frame was mapped to an OVC End Point at the ENNI that is associated by the OVC.</li> </ul>								
Test Purpose	<p>Verify that each egress ENNI Frame is marked Yellow, if the following conditions are fulfilled:</p> <ul style="list-style-type: none"> <li>The egress ENNI Frames were mapped to an ENNI OVC End Point associated by an OVC,</li> <li>The egress ENNI Frames were previously indicated Yellow at the ingress ENNI</li> <li>The following OVC attributes are enabled: the Color Forwarding, the S-Tag PCP color indication at the ingress ENNI, and the S-Tag DEI color indication at the egress ENNI</li> </ul>								
Conditions	<p>Number of ENNI OVC End Points &gt; 1,            Color Forwarding = "Yes",            ENNI1: DEI Color Indication = "Yes",            ENNI2: S-Tag PCP Color Indication = "Yes",            ENNI2: Ingress Bandwidth profile per Class of Service Identifier at ENNI = "Yes"</p>								
Test Topology/OVC	<table border="1" style="width: 100%; margin-top: 10px;"> <thead> <tr> <th>S-VID</th> <th>End Point ID</th> <th>S-VID</th> <th>End Point ID</th> </tr> </thead> <tbody> <tr> <td>SVID32</td> <td>ENNI1_OVC28_End_Point_1</td> <td>SVID33</td> <td>ENNI2_OVC28_End_Point_1</td> </tr> </tbody> </table>	S-VID	End Point ID	S-VID	End Point ID	SVID32	ENNI1_OVC28_End_Point_1	SVID33	ENNI2_OVC28_End_Point_1
S-VID	End Point ID	S-VID	End Point ID						
SVID32	ENNI1_OVC28_End_Point_1	SVID33	ENNI2_OVC28_End_Point_1						
Test Procedure	Tester transmits test frames mapped to OVC28 at ENNI2 per CoS: the information rate is set to 0.5*EIR1, the CoS ID is set to ENNI_Yellow_PCP_CoS1_IDs.								
Expected Results	All test frames are received at ENNI1: CoS ID is set to ENNI_Yellow_DEI_CoS1_IDs.								

Verdict	PASS, FAIL, or INCONCLUSIVE
---------	-----------------------------

**10.10 Yellow Ingress Frames at ENNI, Yellow Color Indication by S-VLAN DEI at Ingress and by S-VLAN PCP at Egress ENNI**

ABSTRACT TEST CASES FOR ENNI PHASE 1									
Test Case ID	COLOR_FORWARDING. R43.6								
Reference Document Source	MEF 26, R43								
Test Status	Conditional Mandatory								
Requirement	<p>When the Color Forwarding attribute is Yes for an OVC, each egress ENNI Frame mapped to an OVC End Point that is associated by the OVC MUST be marked Yellow using one of the formats specified in Section 7.3.2 of [MEF 26] if the corresponding ingress frame into the Operator MEN satisfied one or more of the following:</p> <ul style="list-style-type: none"> <li>The corresponding ingress frame was a Service Frame that was declared Yellow by an Ingress Bandwidth Profile and the Service Frame was mapped to an OVC End Point at the UNI that is associated by the OVC,</li> <li>The corresponding ingress frame was a Service Frame with a frame header indicating Yellow as specified in MEF 23 [MEF 23] and the Service Frame was mapped to an OVC End Point at the UNI that is associated by the OVC,</li> <li>The corresponding ingress frame was an ENNI Frame that was declared Yellow by an Ingress Bandwidth Profile and the ENNI Frame was mapped to an OVC End Point at the ENNI that is associated by the OVC,</li> <li>The corresponding ingress frame was an ENNI Frame with a frame header indicating Yellow using one of the formats specified in Section 7.3.2 of [MEF 26] and the ENNI Frame was mapped to an OVC End Point at the ENNI that is associated by the OVC.</li> </ul>								
Test Purpose	<p>Verify that each egress ENNI Frame is marked Yellow, if the following conditions are fulfilled:</p> <ul style="list-style-type: none"> <li>The egress ENNI Frames were mapped to an ENNI OVC End Point associated by an OVC,</li> <li>The egress ENNI Frames were previously indicated Yellow at the ingress ENNI</li> <li>The following OVC attributes are enabled: the Color Forwarding, the S-Tag DEI color indication at the ingress ENNI, and the S-Tag PCP color indication at the egress ENNI</li> </ul>								
Conditions	<p>Number of ENNI OVC End Points &gt; 1,            Color Forwarding = "Yes",            ENNI1: DEI Color Indication = "Yes",            ENNI2: S-Tag PCP Color Indication = "Yes",            ENNI1: Ingress Bandwidth profile per Class of Service Identifier at ENNI = "Yes"</p>								
Test Topology/OVC	<table border="1" style="width: 100%; text-align: center;"> <tr> <td>S-VID</td> <td>End Point ID</td> <td>S-VID</td> <td>End Point ID</td> </tr> <tr> <td>SVID32</td> <td>ENNI1_OVC28_End_Point_1</td> <td>SVID33</td> <td>ENNI2_OVC28_End_Point_1</td> </tr> </table>	S-VID	End Point ID	S-VID	End Point ID	SVID32	ENNI1_OVC28_End_Point_1	SVID33	ENNI2_OVC28_End_Point_1
S-VID	End Point ID	S-VID	End Point ID						
SVID32	ENNI1_OVC28_End_Point_1	SVID33	ENNI2_OVC28_End_Point_1						
Test Procedure	Tester transmits test frames mapped to OVC28 at ENNI2 per CoS: the information rate is set to 0.5*EIR1, the CoS ID is set to ENNI_Yellow_DEI_CoS1_IDs.								
Expected Results	All test frames are received at ENNI1: CoS ID is set to ENNI_Yellow_PCP_CoS1_IDs.								

Verdict	PASS, FAIL, or INCONCLUSIVE
---------	-----------------------------



## 11 Test Group: Class of Service Identifier

### 11.1 S-Tag PCP Value's for Class of Service Identifiers Attribute in Exactly one Class of Service Identifier

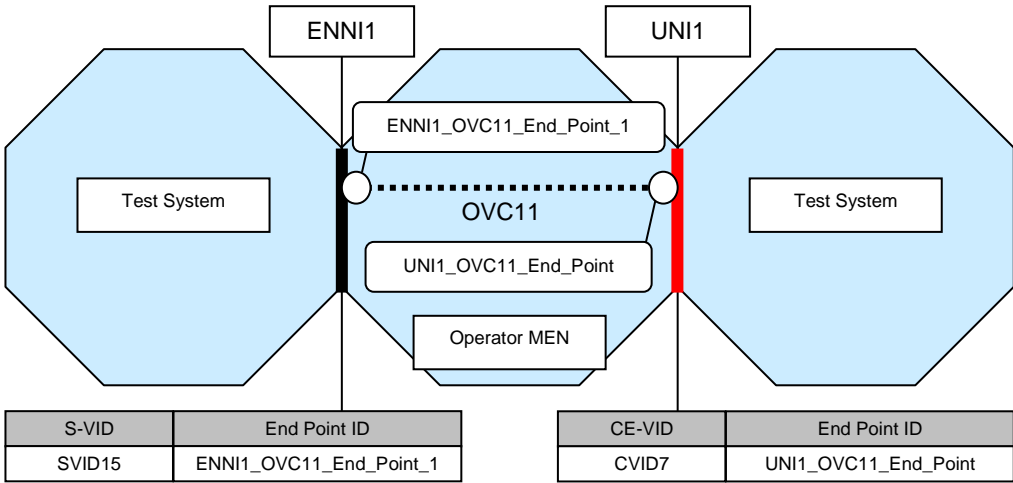
ABSTRACT TEST CASES FOR ENNI PHASE 1	
Test Case ID	STANDARD_COS.R52
Reference Document Source	MEF 26, R52
Test Status	Mandatory
Requirement	For each OVC End Point at an ENNI, each possible S-Tag PCP value <b>MUST</b> be included in exactly one Class of Service Identifier
Test Purpose	Verify that at each OVC End Point the set of S-Tag PCP values of Class of Service Identifier attribute is disjoint and their union content all possible S-Tag PCP values.
Conditions	Number of ENNI CoS > 1, Classifying based on S-Tag PCP = "Yes", Discard CoS at ENNI = "Yes"
Test Topology/OVC	
Test Procedure	Tester transmits S-Tagged test frames mapped to OVC11 at ENNI1: S-Tag PCP is set to each of the values 0 ("BestEffort"), 1, 2, 3, 4, 5, 6 and 7 ("Discard").
Expected Results	All test frames transmitted with S-Tag PCP value 0 are received at UNI1 and mapped to OVC11 Test frames transmitted with any other S-Tag PCP value are not received at any External Interface.
Verdict	PASS, FAIL, or INCONCLUSIVE

11.2 Color Indication at ENNI with S-Tag PCP Value

ABSTRACT TEST CASES FOR ENNI PHASE 1									
Test Case ID	STANDARD_COS.R54.1								
Reference Document Source	MEF 26, R54								
Test Status	Mandatory								
Requirement	Color indication for each ENNI Frame MUST conform to requirements [R3] and [R4] of MEF 23 [MEF 23].								
Test Purpose	Verify that the color of an Egress frame is indicated using S-Tag PCP value, if S-Tag PCP color indication is enabled at the ENNI.								
Conditions	S-Tag PCP Color Indication = "Yes", Number of UNIs > 0, Ingress Bandwidth Profile per Class of Service Identifier at UNI = "Yes"								
Test Topology/OVC	<p>The diagram illustrates a network topology for testing color indication. It features two Test Systems connected to an ENNI1 and a UNI1. The ENNI1 and UNI1 are connected to an OVC32 (Operator MEN). The OVC32 is connected to the ENNI1 and UNI1. The ENNI1 and UNI1 are connected to the OVC32. The OVC32 is connected to the ENNI1 and UNI1. The ENNI1 and UNI1 are connected to the OVC32. The OVC32 is connected to the ENNI1 and UNI1. Below the diagram are two tables:</p> <table border="1"> <thead> <tr> <th>S-VID</th> <th>End Point ID</th> </tr> </thead> <tbody> <tr> <td>SVID38</td> <td>ENNI1_OVC32_End_Point</td> </tr> </tbody> </table> <table border="1"> <thead> <tr> <th>CE-VID</th> <th>End Point ID</th> </tr> </thead> <tbody> <tr> <td>CVID28</td> <td>UNI1_OVC32_End_Point</td> </tr> </tbody> </table>	S-VID	End Point ID	SVID38	ENNI1_OVC32_End_Point	CE-VID	End Point ID	CVID28	UNI1_OVC32_End_Point
S-VID	End Point ID								
SVID38	ENNI1_OVC32_End_Point								
CE-VID	End Point ID								
CVID28	UNI1_OVC32_End_Point								
Test Procedure	Tester transmits test frames mapped to OVC32 at UNI1 per CoS: the information rate is set to $(1.0 - \text{ToleranceFactor}) * \text{CIR1} + 0.5 * \text{EIR1}$ , the CoS ID of all frames is set to UNI_Green_CoS1_IDs								
Expected Results	Test frames are received at ENNI1: CoS ID is set to ENNI_Green_CoS1_IDs, information rate is at least $(1.0 - \text{ToleranceFactor}) * \text{CIR1}$ . More than zero test frames received at ENNI1: CoS ID is set to ENNI_Yellow_PCP_CoS1_IDs, information rate is $0.5 * \text{EIR1}$ or less								
Verdict	PASS, FAIL, or INCONCLUSIVE								

11.3 Color Indication at ENNI with S-Tag DEI

ABSTRACT TEST CASES FOR ENNI PHASE 1									
Test Case ID	STANDARD_COS.R54.2								
Reference Document Source	MEF 26, R54								
Test Status	Conditional Mandatory								
Requirement	Color indication for each ENNI Frame MUST conform to requirements [R3] and [R4] of MEF 23 [MEF 23].								
Test Purpose	Verify that the color of an Egress frame is indicated using S-Tag DEI value, if DEI color indication is enabled at the ENNI.								
Conditions	DEI Color Indication = "Yes", Number of UNIs > 0, Ingress Bandwidth Profile per Class of Service Identifier at UNI = "Yes"								
Test Topology/OVC	<table border="1" style="margin-left: auto; margin-right: auto;"> <tr> <td>S-VID</td> <td>End Point ID</td> <td>CE-VID</td> <td>End Point ID</td> </tr> <tr> <td>SVID38</td> <td>ENNI1_OVC32_End_Point_1Er</td> <td>CVID28</td> <td>UNI1_OVC32_End_Point</td> </tr> </table>	S-VID	End Point ID	CE-VID	End Point ID	SVID38	ENNI1_OVC32_End_Point_1Er	CVID28	UNI1_OVC32_End_Point
S-VID	End Point ID	CE-VID	End Point ID						
SVID38	ENNI1_OVC32_End_Point_1Er	CVID28	UNI1_OVC32_End_Point						
Test Procedure	Tester transmits test frames mapped to OVC32 at UNI1 per CoS: the information rate is set to $(1.0 - \text{ToleranceFactor}) * \text{CIR1} + 0.5 * \text{EIR1}$ , the CoS ID of all frames is set to UNI_Green_CoS1_IDs								
Expected Results	Test frames are received at ENNI1: CoS ID is set to ENNI_Green_CoS1_IDs, information rate is at least $(1.0 - \text{ToleranceFactor}) * \text{CIR1}$ . More than zero test frames received at ENNI1: CoS ID is set to ENNI_Yellow_DEI_CoS1_IDs, information rate is $0.5 * \text{EIR1}$ or less.								
Verdict	PASS, FAIL, or INCONCLUSIVE								

11.4 S-Tag PCP Mapping for MEF 23 CoS Label, Color Indication with S-Tag

PCP

ABSTRACT TEST CASES FOR ENNI PHASE 1									
Test Case ID	STANDARD_COS.R55								
Reference Document Source	MEF 26, R55								
Test Status	Mandatory								
Requirement	If the S-Tag PCP field is used to indicate Color for the ENNI Frame, then the Class of Services attribute MUST map S-Tag PCP values to L, M, and H as per [R8] of MEF 23 [MEF 23].								
Test Purpose	Verify that the PCP values are indicating L, M, and H classes as specified by table 2 column "color Green or Color Yellow" of MEF 23 and the S-Tag PCP is used to identify the color.								
Conditions	S-Tag PCP Color Indication = "Yes" Number of UNIs > 0: UNI1: Ingress Bandwidth Profile per Class of Service Identifier at UNI = "Yes"								
Test Topology/OVC	<p>The diagram illustrates a test topology for OVC32. Two Test Systems are connected to an OVC32 via ENNI1 and UNI1. The OVC32 is connected to an Operator MEN. The ENNI1 and UNI1 connections are shown as vertical lines. The OVC32 is represented by a central box with a dashed line connecting to the ENNI1 and UNI1 connections. Below the diagram are two tables:</p> <table border="1" style="display: inline-table; margin-right: 20px;"> <thead> <tr> <th>S-VID</th> <th>End Point ID</th> </tr> </thead> <tbody> <tr> <td>SVID38</td> <td>ENNI1_OVC32_End_Point</td> </tr> </tbody> </table> <table border="1" style="display: inline-table;"> <thead> <tr> <th>CE-VID</th> <th>End Point ID</th> </tr> </thead> <tbody> <tr> <td>CVID28</td> <td>UNI1_OVC32_End_Point</td> </tr> </tbody> </table>	S-VID	End Point ID	SVID38	ENNI1_OVC32_End_Point	CE-VID	End Point ID	CVID28	UNI1_OVC32_End_Point
S-VID	End Point ID								
SVID38	ENNI1_OVC32_End_Point								
CE-VID	End Point ID								
CVID28	UNI1_OVC32_End_Point								
Test Procedure	For each PCP value tester transmits test frames mapped to OVC32 at UNI1 sequentially: CoS ID is set to UNI_Green_CoS1_IDs, information rate is set to $(1.0 - \text{ToleranceFactor}) * \text{CIR1} + \text{EIR1}$								
Expected Results	Test frames are received at ENNI1 and at least one of the following condition must be fulfilled: <ul style="list-style-type: none"> <li>For frames with S-Tag PCP set to 1, the information rate is at least <math>(1.0 - \text{ToleranceFactor}) * \text{CIR1}</math> and for frames with S-Tag PCP set to 0, the information rate is larger than zero and up to EIR1.</li> <li>For frames with S-Tag PCP set to 3, the information rate is at least <math>(1.0 - \text{ToleranceFactor}) * \text{CIR1}</math> and for frames with S-Tag PCP set to 2, the information rate is larger than zero and up to EIR1.</li> <li>For frames with S-Tag PCP set to 5, the information rate is <math>(1.0 - \text{ToleranceFactor}) * \text{CIR1}</math></li> </ul>								
Verdict	PASS, FAIL, or INCONCLUSIVE								

11.5 S-Tag PCP Mapping for MEF CoS Label, Color Indication with DEI

ABSTRACT TEST CASES FOR ENNI PHASE 1									
Test Case ID	STANDARD_COS.R56								
Reference Document Source	MEF 26, R56								
Test Status	Conditional Mandatory								
Requirement	If the DEI bit is used to indicate Color for the ENNI Frame, then the Class of Services attribute MUST map S-Tag PCP values to L, M, and H as per [R9] of MEF 23 [MEF 23].								
Test Purpose	Verify that the PCP values are indicating L, M, and H classes as specified by table 2 column "CoS w/DEI Green or Color Yellow" of MEF 23 and the DEI is used to identify the color. Verify that the PCP value is mapped to MEF 23 CoS Label as per the table 2 column labeled CoS w/DEI if the DEI bit is used to indicate color								
Conditions	DEI Color Indication = "Yes" Number of UNIs > 0, Ingress Bandwidth Profile per Class of Service Identifier at UNI = "Yes"								
Test Topology/OVC	<table border="1" style="margin-top: 10px;"> <thead> <tr> <th>S-VID</th> <th>End Point ID</th> <th>CE-VID</th> <th>End Point ID</th> </tr> </thead> <tbody> <tr> <td>SVID38</td> <td>ENNI1_OVC32_End_Point</td> <td>CVID28</td> <td>UNI1_OVC32_End_Point</td> </tr> </tbody> </table>	S-VID	End Point ID	CE-VID	End Point ID	SVID38	ENNI1_OVC32_End_Point	CVID28	UNI1_OVC32_End_Point
S-VID	End Point ID	CE-VID	End Point ID						
SVID38	ENNI1_OVC32_End_Point	CVID28	UNI1_OVC32_End_Point						
Test Procedure	For each PCP value tester transmits test frames mapped to OVC32 at UNI1 sequentially: CoS ID is set to UNI_Green_CoS1_IDs, information rate is set to $(1.0 - \text{ToleranceFactor}) * \text{CIR1} + \text{EIR1}$								
Expected Results	Test frames are received at ENNIs and at least one of the following condition must be fulfilled: <ul style="list-style-type: none"> <li>For frames with S-Tag PCP set to 1 and DEI bit set to 0, the information rate is at least <math>(1.0 - \text{ToleranceFactor}) * \text{CIR1}</math> and for frames with S-Tag PCP set to 1 and DEI bit set to 1, the information rate larger than zero and up to EIR1.</li> <li>For frames with S-Tag PCP set to 3 and DEI bit set to 0, the information rate is at least <math>(1.0 - \text{ToleranceFactor}) * \text{CIR1}</math> and for frames with S-Tag PCP set to 3 and DEI bit set to 1, the information rate is larger than zero and up to EIR1.</li> <li>For frames with S-Tag PCP set to 5 and DEI bit set to 0, the information rate is at least <math>(1.0 - \text{ToleranceFactor}) * \text{CIR1}</math> and for frames with S-Tag PCP set to 5 and DEI bit set to 1, the information rate is larger than zero and up to EIR1.</li> </ul>								
Verdict	PASS, FAIL, or INCONCLUSIVE								

## **12 Test Group: ENNI Ingress Bandwidth Profile per CoS**

Please note that the tests of Excess Information Rate (EIR) and of Egress bandwidth profile implementations requires a controlled environment for the Operator MEN. Since there are no performance guarantees on EIR/EBS, the system under test might drop frames below EIR/EBS – which would be compliant with MEF26 but not helpful for the test purpose. Similarly, if traffic moving through the network would exhibit noticeable frame delay variation before hitting the Egress bandwidth profile, the test could not be carried out.

In the sections 12-15, the ATS assumes that the entity conducting the test is able to control congestion in the Operator MEN during the test, ensuring that the tests can be carried out according to their purposes.

12.1 ENNI Ingress BWP per CoS with CIR>0, EIR=0, CF=0, EBS=0, CM=1

ABSTRACT TEST CASES FOR ENNI PHASE 1									
Test Case ID	ENNI_INGRESS_BWP_COS.R61.1								
Reference Document Source	MEF 26, R61, R62, R82, R84, R86, R88								
Test Status	Mandatory								
Requirement	<p>[R61] When the Ingress Bandwidth Profile per Class of Service Identifier is in force for a given ENNI Class of Service Identifier, suitable parameters &lt;CIR, CBS, EIR, EBS, CF, CM&gt; as defined in Section 7.6.1 of [MEF 26] <b>MUST</b> be specified and the algorithm of Section 7.6.1 of [MEF 26] <b>MUST</b> be applied to all ingress ENNI Frames mapped to the OVC End Point that have the given ENNI Class of Service Identifier.</p> <p>[R62] The Bandwidth Profile Algorithm <b>MUST</b> be color-aware.</p> <p>[R82] CIR <b>MUST</b> be <math>\geq 0</math></p> <p>[R84] EIR <b>MUST</b> be <math>\geq 0</math></p> <p>[R86] For a sequence of ENNI Frames, <math>\{t_j, l_j\}, j \geq 0, t_{j+1} \geq t_j</math>, with arrival times at the reference point <math>t_j</math> and lengths <math>l_j</math>, the level of compliance color assigned to each ENNI Frame <b>MUST</b> be defined according to the algorithm in Figure 10 of [MEF 26].</p> <p>[R88] The disposition of each ENNI Frame for delivery to each egress External Interface <b>MUST</b> be as described in Table 11 of [MEF 26].</p>								
Test Purpose	Verify that the ENNI ingress bandwidth profile per CoS with CIR>0 and EIR=0 and CF=0 will limit the information rate of the incoming Green traffic to CIR and drop all other frames.								
Conditions	Color Aware for ENNI Ingress Bandwidth Profile per CoS = "Yes" S-Tag PCP Color Indication = "Yes", Ingress Bandwidth Profile per Class of Service Identifier at ENNI = "Yes"								
Test Topology/OVC	<table border="1" style="width: 100%; margin-top: 10px;"> <thead> <tr> <th>S-VID</th> <th>End Point ID</th> <th>CE-VID</th> <th>End Point ID</th> </tr> </thead> <tbody> <tr> <td>SVID18</td> <td>ENNI1_OVC14_End_Point_1</td> <td>CVID11</td> <td>UNI1_OVC14_End_Point</td> </tr> </tbody> </table>	S-VID	End Point ID	CE-VID	End Point ID	SVID18	ENNI1_OVC14_End_Point_1	CVID11	UNI1_OVC14_End_Point
S-VID	End Point ID	CE-VID	End Point ID						
SVID18	ENNI1_OVC14_End_Point_1	CVID11	UNI1_OVC14_End_Point						
Test Procedure	<ol style="list-style-type: none"> <li>Tester transmits test frames mapped to OVC14 at ENNI1: CoS ID is set to ENNI_Green_CoS1_IDs, information rate is <math>0.5 * CIR1</math></li> <li>Tester transmits test frames mapped to OVC14 at ENNI1: CoS ID is set to ENNI_Green_CoS1_IDs, information rate is <math>(1.0 - ToleranceFactor) * CIR1</math></li> <li>Tester transmits test frames mapped to OVC14 at ENNI1: CoS ID is set to ENNI_Green_CoS1_IDs, information rate is <math>1.5 * CIR1</math></li> <li>Tester transmits test frames A mapped to OVC14 at ENNI1: CoS ID is set to ENNI_Green_CoS1_IDs, information rate is <math>0.5 * CIR1</math>. Tester transmits test frames B mapped to OVC14 at ENNI1: CoS ID is set to ENNI_Yellow_CoS1_IDs, information rate is <math>0.1 * CIR1</math></li> <li>Tester transmits test frames mapped to OVC14 at ENNI1: CoS ID is set to ENNI_Yellow_CoS1_IDs, information rate is <math>0.1 * CIR1</math>.</li> </ol>								
Expected Results	<ol style="list-style-type: none"> <li>All test frames are received at UNI1.</li> <li>All test frames are received at UNI1.</li> <li>A number of frames representing traffic of at least "Flow Transmission Duration" * <math>(1 - ToleranceFactor) * CIR1 + (CBS1 * 8)</math> and at most "Flow Transmission</li> </ol>								



	<p>Duration" * (1 + ToleranceFactor) * CIR1 + (CBS1 * 8) are received at UNI1.</p> <ol style="list-style-type: none"> <li>4. All test frames A are received at UNI1. Test frames B are not received at any External Interface used in this test case.</li> <li>5. Test frames are not received at any External Interface used in this test case.</li> </ol>
Verdict	PASS, FAIL, or INCONCLUSIVE

12.2 ENNI Ingress BWP per CoS with CIR=0, CBS=0, EIR>0, CF=0, EBS>0,  
CM=1

ABSTRACT TEST CASES FOR ENNI PHASE 1									
Test Case ID	ENNI_INGRESS_BWP_COS.R61.4								
Reference Document Source	MEF 26, R61, R62, R82, R84, R86, R88								
Test Status	Mandatory								
Requirement	<p>[R61] When the Ingress Bandwidth Profile per Class of Service Identifier is in force for a given ENNI Class of Service Identifier, suitable parameters &lt;CIR, CBS, EIR, EBS, CF, CM&gt; as defined in Section 7.6.1 of [MEF 26] <b>MUST</b> be specified and the algorithm of Section 7.6.1 of [MEF 26] <b>MUST</b> be applied to all ingress ENNI Frames mapped to the OVC End Point that have the given ENNI Class of Service Identifier.</p> <p>[R62] The Bandwidth Profile Algorithm <b>MUST</b> be color-aware.</p> <p>[R82] CIR <b>MUST</b> be <math>\geq 0</math></p> <p>[R84] EIR <b>MUST</b> be <math>\geq 0</math></p> <p>[R86] For a sequence of ENNI Frames, <math>\{t_j, l_j\}, j \geq 0, t_{j+1} \geq t_j</math>, with arrival times at the reference point <math>t_j</math> and lengths <math>l_j</math>, the level of compliance color assigned to each ENNI Frame <b>MUST</b> be defined according to the algorithm in Figure 10 of [MEF 26].</p> <p>[R88] The disposition of each ENNI Frame for delivery to each egress External Interface <b>MUST</b> be as described in Table 11 of [MEF 26].</p>								
Test Purpose	Verify that the ENNI ingress bandwidth profile per CoS with CIR=0 and EIR>0, will limit the total information rate of the incoming traffic to EIR and drop any excess traffic. All green traffic must be discarded.								
Conditions	Color Aware for ENNI Ingress Bandwidth Profile per CoS = "Yes" S-Tag PCP Color Indication = "Yes", Ingress Bandwidth Profile per Class of Service Identifier at ENNI = "Yes"								
Test Topology/OVC	<table border="1" style="width: 100%; margin-top: 10px;"> <thead> <tr> <th>S-VID</th> <th>End Point ID</th> <th>CE-VID</th> <th>End Point ID</th> </tr> </thead> <tbody> <tr> <td>SVID21</td> <td>ENNI1_OVC17_End_Point_1</td> <td>CVID14</td> <td>UNI1_OVC17_End_Point</td> </tr> </tbody> </table>	S-VID	End Point ID	CE-VID	End Point ID	SVID21	ENNI1_OVC17_End_Point_1	CVID14	UNI1_OVC17_End_Point
S-VID	End Point ID	CE-VID	End Point ID						
SVID21	ENNI1_OVC17_End_Point_1	CVID14	UNI1_OVC17_End_Point						
Test Procedure	<ol style="list-style-type: none"> <li>Tester transmits test frames mapped to OVC17 at ENNI1: CoS ID is set to ENNI_Green_CoS1_IDs, information rate is 0.5*EIR1</li> <li>Tester transmits test frames mapped to OVC17 at ENNI1: CoS ID is set to ENNI_Green_CoS1_IDs, information rate is (1.0 - ToleranceFactor) *EIR1</li> <li>Tester transmits test frames mapped to OVC17 at ENNI1: CoS ID is set to ENNI_Green_CoS1_IDs, information rate is 1.5*EIR1</li> <li>Tester transmits test frames mapped to OVC17 at ENNI1: CoS ID is set to ENNI_Yellow_CoS1_IDs, information rate is 0.5*EIR1</li> <li>Tester transmits test frames mapped to OVC17 at ENNI1: CoS ID is set to ENNI_Yellow_CoS1_IDs, information rate is (1.0 - ToleranceFactor) *EIR1</li> <li>Tester transmits test frames mapped to OVC17 at ENNI1: CoS ID is set to ENNI_Yellow_CoS1_IDs, information rate is 1.5*EIR1</li> <li>Tester transmits test frames A mapped to OVC17 at ENNI1: CoS ID is set to</li> </ol>								

	<p>ENNI_Green_CoS1_IDs, information rate is <math>0.4 * EIR1</math>. Tester transmits test frames B mapped to OVC17 at ENNI1: CoS ID is set to ENNI_Yellow_CoS1_IDs, information rate is <math>0.4 * EIR1</math></p> <p>8. Tester transmits test frames A mapped to OVC17 at ENNI1: CoS ID is set to ENNI_Green_CoS1_IDs, information rate is <math>0.5 * EIR1</math>. Tester transmits test frames B mapped to OVC17 at ENNI1: CoS ID is set to ENNI_Yellow_CoS1_IDs, information rate is <math>0.5 * EIR1</math></p> <p>9. Tester transmits test frames A mapped to OVC17 at ENNI1: CoS ID is set to ENNI_Green_CoS1_IDs, information rate is <math>0.6 * EIR1</math>. Tester transmits test frames B mapped to OVC17 at ENNI1: CoS ID is set to ENNI_Yellow_CoS1_IDs, information rate is <math>0.6 * EIR1</math></p>
Expected Results	<ol style="list-style-type: none"> <li>1. No test frames are received at UNI1.</li> <li>2. No test frames are received at UNI1.</li> <li>3. No test frames are received at UNI1.</li> <li>4. More than zero test frames are received at UNI1.</li> <li>5. More than zero test frames are received at UNI1.</li> <li>6. More than zero test frames are received at UNI1.</li> <li>7. No test frames A are received at UNI1. More than zero test frames B are received at UNI1.</li> <li>8. No test frames A are received at UNI1. More than zero test frames B are received at UNI1.</li> <li>9. No test frames A are received at UNI1 More than zero test frames B are received at UNI1.</li> </ol>
Verdict	PASS, FAIL, or INCONCLUSIVE

12.3 ENNI Ingress BWP per CoS with CIR>0, CBS>0, EIR>0, CF=0, EBS>0,  
CM=1

ABSTRACT TEST CASES FOR ENNI PHASE 1									
Test Case ID	ENNI_INGRESS_BWP_COS.R61.6								
Reference Document Source	MEF 26, R61, R62, R82, R84, R86, R88								
Test Status	Mandatory								
Requirement	<p>[R61] When the Ingress Bandwidth Profile per Class of Service Identifier is in force for a given ENNI Class of Service Identifier, suitable parameters &lt;CIR, CBS, EIR, EBS, CF, CM&gt; as defined in Section 7.6.1 of [MEF 26] <b>MUST</b> be specified and the algorithm of Section 7.6.1 of [MEF 26] <b>MUST</b> be applied to all ingress ENNI Frames mapped to the OVC End Point that have the given ENNI Class of Service Identifier.</p> <p>[R62] The Bandwidth Profile Algorithm <b>MUST</b> be color-aware.</p> <p>[R82] CIR <b>MUST</b> be <math>\geq 0</math></p> <p>[R84] EIR <b>MUST</b> be <math>\geq 0</math></p> <p>[R86] For a sequence of ENNI Frames, <math>\{t_j, l_j\}, j \geq 0, t_{j+1} \geq t_j</math>, with arrival times at the reference point <math>t_j</math> and lengths <math>l_j</math>, the level of compliance color assigned to each ENNI Frame <b>MUST</b> be defined according to the algorithm in Figure 10 of [MEF 26].</p> <p>[R88] The disposition of each ENNI Frame for delivery to each egress External Interface <b>MUST</b> be as described in Table 11 of [MEF 26].</p>								
Test Purpose	Verify that the ENNI ingress bandwidth profile per CoS with CIR>0 and EIR>0, will limit the information rate of the incoming Green traffic to CIR, limit the sum of the excess Green traffic and the Yellow traffic to EIR and drop any excess traffic.								
Conditions	S-Tag PCP Color Indication = "Yes", Ingress Bandwidth Profile per Class of Service Identifier at ENNI = "Yes", Color Aware for ENNI Ingress Bandwidth Profile per CoS = "Yes"								
Test Topology/OVC	<table border="1" style="width: 100%; text-align: center;"> <tr> <td>S-VID</td> <td>End Point ID</td> <td>CE-VID</td> <td>End Point ID</td> </tr> <tr> <td>SVID23</td> <td>ENNI1_OVC19_End_Point_1</td> <td>CVID16</td> <td>UNI1_OVC19_End_Point</td> </tr> </table>	S-VID	End Point ID	CE-VID	End Point ID	SVID23	ENNI1_OVC19_End_Point_1	CVID16	UNI1_OVC19_End_Point
S-VID	End Point ID	CE-VID	End Point ID						
SVID23	ENNI1_OVC19_End_Point_1	CVID16	UNI1_OVC19_End_Point						
Test Procedure	<ol style="list-style-type: none"> <li>Tester transmits test frames mapped to OVC19 at ENNI1: CoS ID is set to ENNI_Green_CoS1_IDs, information rate is <math>0.5 * CIR1</math></li> <li>Tester transmits test frames mapped to OVC19 at ENNI1: CoS ID is set to ENNI_Green_CoS1_IDs, information rate is <math>(1.0 - ToleranceFactor) * CIR1</math></li> <li>Tester transmits test frames mapped to OVC19 at ENNI1: CoS ID is set to ENNI_Green_CoS1_IDs, information rate is <math>(1.0 - ToleranceFactor) * CIR1 + 0.5 * EIR1</math></li> <li>Tester transmits test frames mapped to OVC19 at ENNI1: CoS ID is set to ENNI_Green_CoS1_IDs, information rate is <math>(1.0 - ToleranceFactor) * CIR1 + 1.0 * EIR1</math></li> <li>Tester transmits test frames mapped to OVC19 at ENNI1: CoS ID is set to ENNI_Green_CoS1_IDs, information rate is <math>(1.0 - ToleranceFactor) * CIR1 + 1.5 * EIR1</math></li> </ol>								

	<ol style="list-style-type: none"> <li>6. Tester transmits test frames mapped to OVC19 at ENNI1: CoS ID is set to ENNI_Yellow_CoS1_IDs, information rate is <math>0.5 * EIR1</math></li> <li>7. Tester transmits test frames mapped to OVC19 at ENNI1: CoS ID is set to ENNI_Yellow_CoS1_IDs, information rate is <math>(1.0 - ToleranceFactor) * EIR1</math></li> <li>8. Tester transmits test frames mapped to OVC19 at ENNI1: CoS ID is set to ENNI_Yellow_CoS1_IDs, information rate is <math>1.5 * EIR1</math></li> <li>9. Tester transmits test frames A mapped to OVC19 at ENNI1: CoS ID is set to ENNI_Green_CoS1_IDs, information rate is <math>0.5 * CIR1</math>. Tester transmits test frames mapped to OVC19 B at ENNI1: CoS ID is set to ENNI_Yellow_CoS1_IDs, information rate is <math>0.5 * EIR1</math>.</li> <li>10. Tester transmits test frames A mapped to OVC19 A at ENNI1: CoS ID is set to ENNI_Green_CoS1_IDs, information rate is <math>(1.0 - ToleranceFactor) * CIR1</math>. Tester transmits test frames B mapped to OVC19 at ENNI1: CoS ID is set to ENNI_Yellow_CoS1_IDs, information rate is <math>(1.0 - ToleranceFactor) * EIR1</math>.</li> <li>11. Tester transmits test frames A mapped to OVC19 at ENNI1: CoS ID is set to ENNI_Green_CoS1_IDs, information rate is <math>(1.0 - ToleranceFactor) * CIR1 + 0.5 * EIR1</math>. Tester transmits test frames B mapped to OVC19 at ENNI1: CoS ID is set to ENNI_Yellow_CoS1_IDs, information rate is <math>0.1 * EIR1</math>.</li> <li>12. Tester transmits test frames A mapped to OVC19 at ENNI1: CoS ID is set to ENNI_Green_CoS1_IDs, information rate is <math>(1.0 - ToleranceFactor) * CIR1 + 0.5 * EIR1</math>. Tester transmits test frames B mapped to OVC19 at ENNI1: CoS ID is set to ENNI_Yellow_CoS1_IDs, information rate is <math>0.5 * EIR1</math>.</li> <li>13. Tester transmits test frames A mapped to OVC19 at ENNI1: CoS ID is set to ENNI_Green_CoS1_IDs, information rate is <math>(1.0 - ToleranceFactor) * CIR1 + 0.6 * EIR1</math>. Tester transmits test frames B mapped to OVC19 at ENNI1: CoS ID is set to ENNI_Yellow_CoS1_IDs, information rate is <math>0.6 * EIR1</math>.</li> <li>14. Tester transmits test frames A mapped to OVC19 at ENNI1: CoS ID is set to ENNI_Green_CoS1_IDs, information rate is <math>(1.0 - ToleranceFactor) * CIR1 + 1.0 * EIR1</math>. Tester transmits test frames B mapped to OVC19 at ENNI1: CoS ID is set to ENNI_Yellow_CoS1_IDs, information rate is <math>0.5 * EIR1</math>.</li> <li>15. Tester transmits test frames A mapped to OVC19 at ENNI1: CoS ID is set to ENNI_Green_CoS1_IDs, information rate is <math>(1.0 - ToleranceFactor) * CIR1 + 1.5 * EIR1</math>. Tester transmits test frames B mapped to OVC19 at ENNI1: CoS ID is set to ENNI_Yellow_CoS1_IDs, information rate is <math>0.5 * EIR1</math>.</li> </ol>
<p>Expected Results</p>	<ol style="list-style-type: none"> <li>1. All test frames are received at UNI1.</li> <li>2. All test frames are received at UNI1.</li> <li>3. All test frames are received at UNI1.</li> <li>4. All test frames are received at UNI1.</li> <li>5. Test frames are partially received at UNI1: the information rate of the received test frames is at least <math>(1.0 - ToleranceFactor) * CIR1</math>.</li> <li>6. More than zero test frames are received at UNI1.</li> <li>7. More than zero test frames are received at UNI1.</li> <li>8. More than zero test frames are received at UNI1.</li> <li>9. All test frames A are received at UNI1. More than zero test frames B are received at UNI1.</li> <li>10. All test frames A are received at UNI1. More than zero test frames B are received at UNI1.</li> <li>11. A number of test frames A representing traffic of at least “Flow Transmission Duration” * <math>(1 - ToleranceFactor) * CIR1 + (CBS1 * 8)</math> and at most “Flow Transmission Duration” * <math>(1 + ToleranceFactor) * CIR1 + (CBS1 * 8)</math> are received at UNI1. More than zero test frames B are received at UNI1.</li> <li>12. A number of test frames A representing traffic of at least “Flow Transmission Duration” * <math>(1 - ToleranceFactor) * CIR1 + (CBS1 * 8)</math> and at most “Flow Transmission Duration” * <math>(1 + ToleranceFactor) * CIR1 + (CBS1 * 8)</math> are received at UNI1. More than zero test frames B are received at UNI1.</li> <li>13. A number of test frames A representing traffic of least “Flow Transmission Duration” * <math>(1 - ToleranceFactor) * CIR1 + (CBS1 * 8)</math> A are received at UNI1. More than zero test frames B are received at UNI1.</li> <li>14. A number of test frames A representing traffic of least “Flow Transmission Duration” * <math>(1 - ToleranceFactor) * CIR1 + (CBS1 * 8)</math> are received at UNI1. More than zero test frames B are received at UNI1.</li> </ol>

	15. A number of test frames A representing traffic of least “Flow Transmission Duration” * (1 - ToleranceFactor) * CIR1 + (CBS1 * 8) are received at UNI1. More than zero test frames B are received at UNI1.
Verdict	PASS, FAIL, or INCONCLUSIVE

12.4 ENNI Ingress BWP per CoS: Committed Burst Size, EBS = 0

ABSTRACT TEST CASES FOR ENNI PHASE 1									
Test Case ID	ENNI_INGRESS_BWP_COS. R61.8								
Reference Document Source	MEF 26, R61, R83								
Test Status	Mandatory								
Requirement	[R61] When the Ingress Bandwidth Profile per Class of Service Identifier is in force for a given ENNI Class of Service Identifier, suitable parameters <CIR, CBS, EIR, EBS, CF, CM> as defined in Section 7.6.1 of [MEF 26] <b>MUST</b> be specified and the algorithm of Section 7.6.1 of [MEF 26] <b>MUST</b> be applied to all ingress ENNI Frames mapped to the OVC End Point that have the given ENNI Class of Service Identifier. [R83] When CIR > 0, CBS <b>MUST</b> be greater than or equal to the largest Maximum Transmission Unit size allowed for the ENNI Frames that the Bandwidth Profile applies to.								
Test Purpose	Verify that ENNI ingress bandwidth profile per CoS with CIR>0 will forward bursts of Green traffic of at least MTU size and at most CBS size.								
Conditions	Color Aware for ENNI Ingress Bandwidth Profile per CoS = "Yes" S-Tag PCP Color Indication = "Yes", Ingress Bandwidth Profile per Class of Service Identifier at ENNI = "Yes"								
Test Topology/OVC	<table border="1" style="margin-top: 10px;"> <thead> <tr> <th>S-VID</th> <th>End Point ID</th> <th>CE-VID</th> <th>End Point ID</th> </tr> </thead> <tbody> <tr> <td>SVID18</td> <td>ENNI1_OVC14_End_Point_1</td> <td>CVID11</td> <td>UNI1_OVC14_End_Point</td> </tr> </tbody> </table>	S-VID	End Point ID	CE-VID	End Point ID	SVID18	ENNI1_OVC14_End_Point_1	CVID11	UNI1_OVC14_End_Point
S-VID	End Point ID	CE-VID	End Point ID						
SVID18	ENNI1_OVC14_End_Point_1	CVID11	UNI1_OVC14_End_Point						
Test Procedure	<ol style="list-style-type: none"> <li>1. Tester transmits bursts of test frames mapped to OVC14 at ENNI1: CoS ID is set to ENNI_Green_CoS1_IDs, total burst size is 0.5*CBS1 octets, at a rate of 1 burst every 1 second</li> <li>2. Tester transmits bursts of test frames mapped to OVC14 at ENNI1: CoS ID is set to ENNI_Green_CoS1_IDs, total burst size is 1.0*CBS1 octets rounded down to the next whole frame, at a rate of 1 burst every 1 second</li> <li>3. Tester transmits bursts of test frames mapped to OVC14 at ENNI1: CoS ID is set to ENNI_Green_CoS1_IDs, total burst size rounded up to the nearest whole frame is 1.25 * CBS1 * BIR / (BIR-CIR1), at a rate of 1 burst every 1 second</li> <li>4. Tester transmits bursts of test frames mapped to OVC14 at ENNI1: CoS ID is set to ENNI_Green_CoS1_IDs. Perform the burst procedure described in section 17.3 in this document.</li> </ol>								
Expected Results	<ol style="list-style-type: none"> <li>1. All test frames are received at UNI1.</li> <li>2. All test frames are received at UNI1.</li> <li>3. The amount of traffic received at UNI1 is lower bound by N<sub>G</sub> and upper bound by N<sub>G</sub> plus half of the transmitted traffic in excess of N<sub>G</sub>.</li> <li>4. All expected test frames are received at UNI1.</li> </ol>								
Verdict	PASS, FAIL, or INCONCLUSIVE								

12.5 ENNI Ingress BWP per CoS: Excess Burst Size.

ABSTRACT TEST CASES FOR ENNI PHASE 1									
Test Case ID	ENNI_INGRESS_BWP_COS. R61.9								
Reference Document Source	MEF 26, R61, R85								
Test Status	Mandatory								
Requirement	[R61] When the Ingress Bandwidth Profile per Class of Service Identifier is in force for a given ENNI Class of Service Identifier, suitable parameters <CIR, CBS, EIR, EBS, CF, CM> as defined in Section 7.6.1 of [MEF 26] <b>MUST</b> be specified and the algorithm of Section 7.6.1 of [MEF 26] <b>MUST</b> be applied to all ingress ENNI Frames mapped to the OVC End Point that have the given ENNI Class of Service Identifier. [R85] When EIR > 0, EBS <b>MUST</b> be greater than or equal to the largest Maximum Transmission Unit size allowed for the ENNI Frames that the Bandwidth Profile applies to.								
Test Purpose	Verify that ENNI ingress bandwidth profile per CoS with CIR>0 will forward bursts of Yellow traffic of at least MTU size and at most EBS size.								
Conditions	Color Aware for ENNI Ingress Bandwidth Profile per CoS = "Yes" S-Tag PCP Color Indication = "Yes", Ingress Bandwidth Profile per Class of Service Identifier at ENNI = "Yes"								
Test Topology/OVC	<table border="1" style="margin-left: auto; margin-right: auto;"> <tr> <td>S-VID</td> <td>End Point ID</td> <td>CE-VID</td> <td>End Point ID</td> </tr> <tr> <td>SVID21</td> <td>ENNI1_OVC17_End_Point_1</td> <td>CVID14</td> <td>UNI1_OVC17_End_Point</td> </tr> </table>	S-VID	End Point ID	CE-VID	End Point ID	SVID21	ENNI1_OVC17_End_Point_1	CVID14	UNI1_OVC17_End_Point
S-VID	End Point ID	CE-VID	End Point ID						
SVID21	ENNI1_OVC17_End_Point_1	CVID14	UNI1_OVC17_End_Point						
Test Procedure	<ol style="list-style-type: none"> <li>1. Tester transmits bursts of test frames mapped to OVC17 at ENNI1: CoS ID is set to ENNI_Yellow_CoS1_IDs, total burst size is 0.5*EBS1 octets, at a rate of 1 burst every 1 second</li> <li>2. Tester transmits bursts of test frames mapped to OVC17 at ENNI1: CoS ID is set to ENNI_Yellow_CoS1_IDs, total burst size is 1.0*EBS1 octets rounded down to the next whole frame, at a rate of 1 burst every 1 second</li> <li>3. Tester transmits bursts of test frames mapped to OVC17 at ENNI1: CoS ID is set to ENNI_Yellow_CoS1_IDs, total burst size is (1.25* EBS1 rounded up to the nearest whole frame) * BIR /(BIR-EIR1), at a rate of 1 burst every 1 second</li> <li>4. Tester transmits bursts of test frames mapped to OVC17 at ENNI1: CoS ID is set to ENNI_Yellow_CoS1_IDs. Perform the burst test procedure described in section 17.3 in this document).</li> </ol>								
Expected Results	<ol style="list-style-type: none"> <li>1. More than zero test frames are received at UNI1.</li> <li>2. More than zero test frames are received at UNI1.</li> <li>3. The amount of traffic received at UNI1 is larger than zero frames and upper bound by N<sub>Y</sub> plus half of the transmitted traffic in excess of N<sub>Y</sub>.</li> <li>4. All green test frames are received at UNI1, and more than zero yellow frames are received.</li> </ol>								
Verdict	PASS, FAIL, or INCONCLUSIVE								



## 13 Test Group: ENNI Egress Bandwidth Profile per CoS

13.1 ENNI Egress BWP per CoS with CIR>0, EIR=0, CF=0, EBS=0, CM=1

ABSTRACT TEST CASES FOR ENNI PHASE 1									
Test Case ID	ENNI_EGRESS_BWP_COS.R63.1								
Reference Document Source	MEF 26, R63, R64, R82, R84, R89								
Test Status	Conditional Mandatory								
Requirement	<p>[R63] When the Egress Bandwidth Profile per Class of Service Identifier is in force for a given ENNI Class of Service Identifier, suitable parameters &lt;CIR, CBS, EIR, EBS, CF, CM&gt; as defined in Section 7.6.1 of [MEF 26] <b>MUST</b> be specified and all egress ENNI Frames mapped to the OVC End Point with the given Class of Service Identifier <b>MUST</b> have the property defined in Section 7.6.3 of [MEF 26].</p> <p>[R64] The Color Mode for the Bandwidth Profile Algorithm <b>MUST</b> be color-aware.</p> <p>[R82] CIR <b>MUST</b> be <math>\geq 0</math></p> <p>[R84] EIR <b>MUST</b> be <math>\geq 0</math></p> <p>[R89] When a sequence of egress ENNI Frames with arrival times and lengths at the ENNI, <math>\{t_j, l_j\}, j \geq 0</math> are subjected to an Egress Bandwidth Profile with parameters &lt;CIR, CBS, EIR, EBS, CF, CM&gt;, the result of applying the algorithm of Section 7.6.1 of [MEF 26] to these frames <b>MUST</b> be to declare each ENNI Frame either Green or Yellow.</p>								
Test Purpose	Verify that the ENNI egress bandwidth profile per CoS with CIR>0 and EIR=0 and CF=0 will limit the information rate of the incoming Green traffic to CIR and drop all other frames.								
Conditions	Color Aware for ENNI Egress Bandwidth Profile per CoS = "Yes" S-Tag PCP Color Indication = "Yes", Egress Bandwidth Profile per Class of Service Identifier at ENNI = "Yes"								
Test Topology/OVC	<table border="1" style="width: 100%; margin-top: 10px;"> <thead> <tr> <th>S-VID</th> <th>End Point ID</th> <th>CE-VID</th> <th>End Point ID</th> </tr> </thead> <tbody> <tr> <td>SVID18</td> <td>ENNI1_OVC14_End_Point_1</td> <td>CVID11</td> <td>UNI1_OVC14_End_Point</td> </tr> </tbody> </table>	S-VID	End Point ID	CE-VID	End Point ID	SVID18	ENNI1_OVC14_End_Point_1	CVID11	UNI1_OVC14_End_Point
S-VID	End Point ID	CE-VID	End Point ID						
SVID18	ENNI1_OVC14_End_Point_1	CVID11	UNI1_OVC14_End_Point						
Test Procedure	<ol style="list-style-type: none"> <li>Tester transmits test frames mapped to OVC14 at ENNI1: CoS ID is set to EI_Green_CoS1_IDs, information rate is <math>0.5 * CIR1</math></li> <li>Tester transmits test frames mapped to OVC14 at UNI1: CoS ID is set to EI_Green_CoS1_IDs, information rate is <math>(1.0 - ToleranceFactor) * CIR1</math></li> <li>Tester transmits test frames mapped to OVC14 at UNI1: CoS ID is set to EI_Green_CoS1_IDs, information rate is <math>1.5 * CIR1</math></li> <li>Tester transmits test frames A mapped to OVC14 at UNI1: CoS ID is set to EI_Green_CoS1_IDs, information rate is <math>0.5 * CIR1</math>. Tester transmits test frames B mapped to OVC14 at UNI1: CoS ID is set to EI_Yellow_CoS1_IDs, information rate is <math>0.1 * CIR1</math></li> <li>Tester transmits test frames mapped to OVC14 at UNI1: CoS ID is set to EI_Yellow_CoS1_IDs, information rate is <math>0.1 * CIR1</math>.</li> </ol>								
Expected Results	<ol style="list-style-type: none"> <li>All test frames are received at ENNI1.</li> <li>All test frames are received at ENNI1.</li> <li>Test frames are partially received at ENNI1: in total a number of frames representing traffic of at least "Flow Transmission Duration" * <math>(1 - ToleranceFactor) * CIR1 + (CBS1 * 8)</math> and at most "Flow Transmission Duration" * <math>(1 + ToleranceFactor) * CIR1 + (CBS1 * 8)</math>:</li> </ol>								

	<ol style="list-style-type: none"><li>4. All test frames A are received at ENNI1. Test frames B are not received at any External Interface used in this test.</li><li>5. Test frames are not received at any External Interface used in this test.</li></ol>
Verdict	PASS, FAIL, or INCONCLUSIVE

13.2 ENNI Egress BWP per CoS with CIR=0, EIR>0, CF=0, EBS>0, CM=1

ABSTRACT TEST CASES FOR ENNI PHASE 1									
Test Case ID	ENNI_EGRESS_BWP_COS.R63.4								
Reference Document Source	MEF 26, R63, R64, R82, R84, R89								
Test Status	Conditional Mandatory								
Requirement	<p>[R63] When the Egress Bandwidth Profile per Class of Service Identifier is in force for a given ENNI Class of Service Identifier, suitable parameters &lt;CIR, CBS, EIR, EBS, CF, CM&gt; as defined in Section 7.6.1 of [MEF 26] <b>MUST</b> be specified and all egress ENNI Frames mapped to the OVC End Point with the given Class of Service Identifier <b>MUST</b> have the property defined in Section 7.6.3 of [MEF 26].</p> <p>[R64] The Color Mode for the Bandwidth Profile Algorithm <b>MUST</b> be color-aware.</p> <p>[R82] CIR <b>MUST</b> be <math>\geq 0</math></p> <p>[R84] EIR <b>MUST</b> be <math>\geq 0</math></p> <p>[R89] When a sequence of egress ENNI Frames with arrival times and lengths at the ENNI, <math>\{t_j, l_j\}, j \geq 0</math> are subjected to an Egress Bandwidth Profile with parameters &lt;CIR, CBS, EIR, EBS, CF, CM&gt;, the result of applying the algorithm of Section 7.6.1 of [MEF 26] to these frames <b>MUST</b> be to declare each ENNI Frame either Green or Yellow.</p>								
Test Purpose	Verify that the ENNI egress bandwidth profile per CoS with CIR=0 and EIR>0, will limit the total information rate of the incoming traffic to EIR and drop any excess traffic. All green traffic must be discarded.								
Conditions	Color Aware for ENNI Egress Bandwidth Profile per CoS = "Yes" S-Tag PCP Color Indication = "Yes", Egress Bandwidth Profile per Class of Service Identifier at ENNI = "Yes"								
Test Topology/OVC	<table border="1" style="width: 100%; margin-top: 10px;"> <thead> <tr> <th>S-VID</th> <th>End Point ID</th> <th>CE-VID</th> <th>End Point ID</th> </tr> </thead> <tbody> <tr> <td>SVID21</td> <td>ENNI1_OVC17_End_Point_1</td> <td>CVID14</td> <td>UNI1_OVC17_End_Point</td> </tr> </tbody> </table>	S-VID	End Point ID	CE-VID	End Point ID	SVID21	ENNI1_OVC17_End_Point_1	CVID14	UNI1_OVC17_End_Point
S-VID	End Point ID	CE-VID	End Point ID						
SVID21	ENNI1_OVC17_End_Point_1	CVID14	UNI1_OVC17_End_Point						
Test Procedure	<ol style="list-style-type: none"> <li>Tester transmits test frames mapped to OVC17 at UNI1: CoS ID is set to EI_Green_CoS1_IDs, information rate is 0.5*EIR1</li> <li>Tester transmits test frames mapped to OVC17 at UNI1: CoS ID is set to EI_Green_CoS1_IDs, information rate is (1.0 - ToleranceFactor) *EIR1</li> <li>Tester transmits test frames mapped to OVC17 at UNI1: CoS ID is set to EI_Green_CoS1_IDs, information rate is 1.5*EIR1</li> <li>Tester transmits test frames mapped to OVC17 at UNI1: CoS ID is set to EI_Yellow_CoS1_IDs, information rate is 0.5*EIR1</li> <li>Tester transmits test frames mapped to OVC17 at UNI1: CoS ID is set to EI_Yellow_CoS1_IDs, information rate is (1.0 - ToleranceFactor) *EIR1</li> <li>Tester transmits test frames mapped to OVC17 at UNI1: CoS ID is set to EI_Yellow_CoS1_IDs, information rate is 1.5*EIR1</li> <li>Tester transmits test frames A mapped to OVC17 at UNI1: CoS ID is set to EI_Green_CoS1_IDs, information rate is 0.4*EIR1. Tester transmits test frames B mapped to OVC17 at UNI1: CoS ID is set to EI_Yellow_CoS1_IDs, information rate is 0.4*EIR1</li> <li>Tester transmits test frames A mapped to OVC17 at UNI1: CoS ID is set to</li> </ol>								

	<p>EI_Green_CoS1_IDs, information rate is 0.5*EIR1. Tester transmits test frames B mapped to OVC17 at UNI1: CoS ID is set to EI_Yellow_CoS1_IDs, information rate is 0.5*EIR1</p> <p>9. Tester transmits test frames A mapped to OVC17 at UNI1: CoS ID is set to EI_Green_CoS1_IDs, information rate is 0.6*EIR1. Tester transmits test frames B mapped to OVC17 at UNI1: CoS ID is set to EI_Yellow_CoS1_IDs, information rate is 0.6*EIR1</p>
Expected Results	<ol style="list-style-type: none"> <li>1. No test frames are received at ENNI1.</li> <li>2. No test frames are received at ENNI1.</li> <li>3. No test frames are received at ENNI1.</li> <li>4. More than zero test frames are received at ENNI1.</li> <li>5. More than zero test frames are received at ENNI1.</li> <li>6. More than zero test frames are received at ENNI1.</li> <li>7. No test frames A are received at ENNI1. More than zero test frames B are received at ENNI1.</li> <li>8. No test frames A are received at ENNI1. More than zero test frames B are received at ENNI1.</li> <li>9. No test frames A are received at ENNI1. More than zero test frames B are received at ENNI1.</li> </ol>
Verdict	PASS, FAIL, or INCONCLUSIVE

13.3 ENNI Egress BWP per CoS with CIR>0, EIR>0, CF=0, EBS>0, CM=1

ABSTRACT TEST CASES FOR ENNI PHASE 1									
Test Case ID	ENNI_EGRESS_BWP_COS.R63.6								
Reference Document Source	MEF 26, R63, R64, R82, R84, R89								
Test Status	Conditional Mandatory								
Requirement	<p>[R63] When the Egress Bandwidth Profile per Class of Service Identifier is in force for a given ENNI Class of Service Identifier, suitable parameters &lt;CIR, CBS, EIR, EBS, CF, CM&gt; as defined in Section 7.6.1 of [MEF 26] <b>MUST</b> be specified and all egress ENNI Frames mapped to the OVC End Point with the given Class of Service Identifier <b>MUST</b> have the property defined in Section 7.6.3 of [MEF 26].</p> <p>[R64] The Color Mode for the Bandwidth Profile Algorithm <b>MUST</b> be color-aware.</p> <p>[R82] CIR <b>MUST</b> be <math>\geq 0</math></p> <p>[R84] EIR <b>MUST</b> be <math>\geq 0</math></p> <p>[R89] When a sequence of egress ENNI Frames with arrival times and lengths at the ENNI, <math>\{t_j, l_j\}, j \geq 0</math> are subjected to an Egress Bandwidth Profile with parameters &lt;CIR, CBS, EIR, EBS, CF, CM&gt;, the result of applying the algorithm of Section 7.6.1 of [MEF 26] to these frames <b>MUST</b> be to declare each ENNI Frame either Green or Yellow.</p>								
Test Purpose	Verify that the ENNI egress bandwidth profile per CoS with CIR>0 and EIR>0, will limit the information rate of the incoming Green traffic to CIR, limit the sum of the excess Green traffic and the Yellow traffic to EIR and drop any excess traffic.								
Conditions	Color Aware for ENNI Egress Bandwidth Profile per CoS = "Yes" S-Tag PCP Color Indication = "Yes", Egress Bandwidth Profile per Class of Service Identifier at ENNI = "Yes"								
Test Topology/OVC	<table border="1" style="margin-top: 10px;"> <thead> <tr> <th>S-VID</th> <th>End Point ID</th> <th>CE-VID</th> <th>End Point ID</th> </tr> </thead> <tbody> <tr> <td>SVID23</td> <td>ENNI1_OVC19_End_Point_1</td> <td>CVID16</td> <td>UNI1_OVC19_End_Point</td> </tr> </tbody> </table>	S-VID	End Point ID	CE-VID	End Point ID	SVID23	ENNI1_OVC19_End_Point_1	CVID16	UNI1_OVC19_End_Point
S-VID	End Point ID	CE-VID	End Point ID						
SVID23	ENNI1_OVC19_End_Point_1	CVID16	UNI1_OVC19_End_Point						
Test Procedure	<ol style="list-style-type: none"> <li>Tester transmits test frames mapped to OVC19 at UNI1: CoS ID is set to EI_Green_CoS1_IDs, information rate is 0.5*CIR1</li> <li>Tester transmits test frames mapped to OVC19 at UNI1: CoS ID is set to EI_Green_CoS1_IDs, information rate is (1.0 - ToleranceFactor) * CIR1</li> <li>Tester transmits test frames mapped to OVC19 at UNI1: CoS ID is set to EI_Green_CoS1_IDs, information rate is (1.0 - ToleranceFactor) * CIR1+0.5*EIR1</li> <li>Tester transmits test frames mapped to OVC19 at UNI1: CoS ID is set to EI_Green_CoS1_IDs, information rate is (1.0 - ToleranceFactor) * CIR1+1.0*EIR1</li> <li>Tester transmits test frames mapped to OVC19 at UNI1: CoS ID is set to EI_Green_CoS1_IDs, information rate is (1.0 - ToleranceFactor) * CIR1+1.5*EIR1</li> <li>Tester transmits test frames mapped to OVC19 at UNI1: CoS ID is set to EI_Yellow_CoS1_IDs, information rate is 0.5*EIR1</li> <li>Tester transmits test frames mapped to OVC19 at UNI1: CoS ID is set to EI_Yellow_CoS1_IDs, information rate is (1.0 - ToleranceFactor) * EIR1</li> <li>Tester transmits test frames mapped to OVC19 at UNI1: CoS ID is set to EI_Yellow_CoS1_IDs, information rate is 1.5*EIR1</li> <li>Tester transmits test frames A mapped to OVC19 at UNI1: CoS ID is set to</li> </ol>								

	<p>EI_Green_CoS1_IDs, information rate is <math>0.5 * CIR1</math>. Tester transmits test frames B mapped to OVC19 at External Interface not equal to ENNI1: CoS ID is set to EI_Yellow_CoS1_IDs, information rate is <math>0.5 * EIR1</math>.</p> <p>10. Tester transmits test frames A mapped to OVC19 at UNI1: CoS ID is set to EI_Green_CoS1_IDs, information rate is <math>(1.0 - ToleranceFactor) * CIR1</math>. Tester transmits test frames B mapped to OVC19 at UNI1: CoS ID is set to EI_Yellow_CoS1_IDs, information rate is <math>(1.0 - ToleranceFactor) * EIR1</math>.</p> <p>11. Tester transmits test frames A mapped to OVC19 at UNI1: CoS ID is set to EI_Green_CoS1_IDs, information rate is <math>(1.0 - ToleranceFactor) * CIR1 + 0.5 * EIR1</math>. Tester transmits test frames B mapped to OVC19 at UNI1: CoS ID is set to EI_Yellow_CoS1_IDs, information rate is <math>0.1 * EIR1</math>.</p> <p>12. Tester transmits test frames A mapped to OVC19 at UNI1: CoS ID is set to EI_Green_CoS1_IDs, information rate is <math>(1.0 - ToleranceFactor) * CIR1 + 0.5 * EIR1</math>. Tester transmits test frames B mapped to OVC19 at UNI1: CoS ID is set to EI_Yellow_CoS1_IDs, information rate is <math>0.5 * EIR1</math>.</p> <p>13. Tester transmits test frames A mapped to OVC19 at UNI1: CoS ID is set to EI_Green_CoS1_IDs, information rate is <math>(1.0 - ToleranceFactor) * CIR1 + 0.6 * EIR1</math>. Tester transmits test frames B mapped to OVC19 at UNI1: CoS ID is set to EI_Yellow_CoS1_IDs, information rate is <math>0.6 * EIR1</math>.</p> <p>14. Tester transmits test frames A mapped to OVC19 at UNI1: CoS ID is set to EI_Green_CoS1_IDs, information rate is <math>(1.0 - ToleranceFactor) * CIR1 + 1.0 * EIR1</math>. Tester transmits test B frames mapped to OVC19 at UNI1: CoS ID is set to EI_Yellow_CoS1_IDs, information rate is <math>0.5 * EIR1</math>.</p> <p>15. Tester transmits test frames A mapped to OVC19 at UNI1: CoS ID is set to EI_Green_CoS1_IDs, information rate is <math>(1.0 - ToleranceFactor) * CIR1 + 1.5 * EIR1</math>. Tester transmits test frames B mapped to OVC19 at UNI1: CoS ID is set to EI_Yellow_CoS1_IDs, information rate is <math>0.5 * EIR1</math>.</p>
<p>Expected Results</p>	<ol style="list-style-type: none"> <li>1. All test frames are received at ENNI1.</li> <li>2. All test frames are received at ENNI1.</li> <li>3. All test frames are received at ENNI1.</li> <li>4. All test frames are received at ENNI1.</li> <li>5. Test frames are partially received at ENNI1: the information rate of the received test frames is at least <math>(1.0 - ToleranceFactor) * CIR1</math>.</li> <li>6. More than zero test frames are received at ENNI1.</li> <li>7. More than zero test frames are received at ENNI1.</li> <li>8. More than zero test frames are partially received at ENNI1.</li> <li>9. All test frames A are received at ENNI1. More than zero test frames B are received at ENNI1.</li> <li>10. All test frames A are received at ENNI1. More than zero test frames B are received at ENNI1.</li> <li>11. All test frames A are received at ENNI1. More than zero test frames B are received at ENNI1.</li> <li>12. All test frames A are received at ENNI1. More than zero test frames B are received at ENNI1.</li> <li>13. A number of test frames A representing traffic of least "Flow Transmission Duration" * <math>(1 - ToleranceFactor) * CIR1 + (CBS1 * 8)</math> are received at ENNI1. More than zero test frames B are received at ENNI1.</li> <li>14. Test frames A are partially received at ENNI1: the information rate of the received test frames is at least <math>(1.0 - ToleranceFactor) * CIR1</math>. More than zero test frames B are received at ENNI1.</li> <li>15. Test frames A are partially received at ENNI1: the information rate of the received test frames is at least <math>(1.0 - ToleranceFactor) * CIR1</math>. More than zero test frames B are received at ENNI1.</li> </ol>
<p>Verdict</p>	<p>PASS, FAIL, or INCONCLUSIVE</p>

13.4 ENNI Egress BWP per CoS: Excess Burst Size.

ABSTRACT TEST CASES FOR ENNI PHASE 1									
Test Case ID	ENNI_EGRESS_BWP_COS.R63.9								
Reference Document Source	MEF 26, R63, R85								
Test Status	Conditional Mandatory								
Requirement	[R63] When the Egress Bandwidth Profile per Class of Service Identifier is in force for a given ENNI Class of Service Identifier, suitable parameters <CIR, CBS, EIR, EBS, CF, CM> as defined in Section 7.6.1 of [MEF 26] <b>MUST</b> be specified and all egress ENNI Frames mapped to the OVC End Point with the given Class of Service Identifier <b>MUST</b> have the property defined in Section 7.6.3 of [MEF 26]. [R85] When EIR > 0, EBS <b>MUST</b> be greater than or equal to the largest Maximum Transmission Unit size allowed for the ENNI Frames that the Bandwidth Profile applies to.								
Test Purpose	Verify that ENNI egress bandwidth profile per CoS with CIR>0 will forward bursts of Yellow traffic of at least MTU size and at most EBS size.								
Conditions	Color Aware for ENNI Egress Bandwidth Profile per CoS = "Yes" S-Tag PCP Color Indication = "Yes", Egress Bandwidth Profile per Class of Service Identifier at ENNI = "Yes"								
Test Topology/OVC	<p>The diagram illustrates the test topology for OVC. It shows two Test Systems connected to an OVC17. The OVC17 is connected to an Operator MEN. The OVC17 is connected to ENNI1 and UNI1. The OVC17 is connected to ENNI1_OVC17_End_Point_1 and UNI1_OVC17_End_Point. Below the diagram are two tables for S-VID and CE-VID.</p> <table border="1"> <thead> <tr> <th>S-VID</th> <th>End Point ID</th> <th>CE-VID</th> <th>End Point ID</th> </tr> </thead> <tbody> <tr> <td>SVID21</td> <td>ENNI1_OVC17_End_Point_1</td> <td>CVID14</td> <td>UNI1_OVC17_End_Point</td> </tr> </tbody> </table>	S-VID	End Point ID	CE-VID	End Point ID	SVID21	ENNI1_OVC17_End_Point_1	CVID14	UNI1_OVC17_End_Point
S-VID	End Point ID	CE-VID	End Point ID						
SVID21	ENNI1_OVC17_End_Point_1	CVID14	UNI1_OVC17_End_Point						
Test Procedure	<ol style="list-style-type: none"> <li>1. Tester transmits bursts of test frames mapped to OVC17 at UNI1: CoS ID is set to EI_Yellow_CoS1_IDs, total burst size is 0.5* EBS1 octets, at a rate of 1 burst every 1 second</li> <li>2. Tester transmits bursts of test frames mapped to OVC17 at UNI1: CoS ID is set to EI_Yellow_CoS1_IDs, total burst size is 1.0*EBS1 octets rounded down to the next whole frame, at a rate of 1 burst every 1 second</li> <li>3. Tester transmits bursts of test frames mapped to OVC17 at UNI1: CoS ID is set to EI_Yellow_CoS1_IDs, total burst size is (1.25*EBS1 rounded up to the nearest whole frame) * BIR / (BIR-CIR1), at a rate of 1 burst every 1 second</li> <li>4. Tester transmits bursts of test frames mapped to OVC17 at UNI1: CoS ID is set to EI_Yellow_CoS1_IDs. Perform the burst procedure described in section 17.3 in this document.</li> </ol>								
Expected Results	<ol style="list-style-type: none"> <li>1. More than zero test frames are received at ENNI1.</li> <li>2. More than zero test frames are received at ENNI1.</li> <li>3. The amount of traffic received at UNI1 is larger than zero frames and upper bound by N<sub>Y</sub> plus half of the transmitted traffic in excess of N<sub>Y</sub>. All green test frames are received at ENNI1, and more than zero yellow frames are received.</li> </ol>								
Verdict	PASS, FAIL, or INCONCLUSIVE								



13.5 ENNI Egress BWP per CoS: Committed Burst Size, EBS = 0

ABSTRACT TEST CASES FOR ENNI PHASE 1									
Test Case ID	ENNI_EGRESS_BWP_COS.R63.8								
Reference Document Source	MEF 26, R63, R83								
Test Status	Conditional Mandatory								
Requirement	[R63] When the Egress Bandwidth Profile per Class of Service Identifier is in force for a given ENNI Class of Service Identifier, suitable parameters <CIR, CBS, EIR, EBS, CF, CM> as defined in Section 7.6.1 of [MEF 26] <b>MUST</b> be specified and all egress ENNI Frames mapped to the OVC End Point with the given Class of Service Identifier <b>MUST</b> have the property defined in Section 7.6.3 of [MEF 26]. [R83] When CIR > 0, CBS <b>MUST</b> be greater than or equal to the largest Maximum Transmission Unit size allowed for the ENNI Frames that the Bandwidth Profile applies to.								
Test Purpose	Verify that ENNI egress bandwidth profile per CoS with CIR>0 will forward bursts of Green traffic of at least MTU size and at most CBS size.								
Conditions	Color Aware for ENNI Egress Bandwidth Profile per CoS = "Yes" S-Tag PCP Color Indication = "Yes", Egress Bandwidth Profile per Class of Service Identifier at ENNI = "Yes"								
Test Topology/OVC	<table border="1" style="width: 100%; margin-top: 10px;"> <tr> <td style="width: 50%;">S-VID</td> <td style="width: 50%;">End Point ID</td> <td style="width: 50%;">CE-VID</td> <td style="width: 50%;">End Point ID</td> </tr> <tr> <td>SVID18</td> <td>ENNI1_OVC14_End_Point_1</td> <td>CVID11</td> <td>UNI1_OVC14_End_Point</td> </tr> </table>	S-VID	End Point ID	CE-VID	End Point ID	SVID18	ENNI1_OVC14_End_Point_1	CVID11	UNI1_OVC14_End_Point
S-VID	End Point ID	CE-VID	End Point ID						
SVID18	ENNI1_OVC14_End_Point_1	CVID11	UNI1_OVC14_End_Point						
Test Procedure	<ol style="list-style-type: none"> <li>Tester transmits bursts of test frames mapped to OVC14 at UNI1: CoS ID is set to EI_Green_CoS1_IDs, total burst size is 0.5*CBS1-octets, at a rate of 1 burst every 1 second</li> <li>Tester transmits bursts of test frames mapped to OVC14 at UNI1: CoS ID is set to EI_Green_CoS1_IDs, total burst size is 1.0*CBS1 octets rounded down to the next whole frame, at a rate of 1 burst every 1 second</li> <li>Tester transmits bursts of test frames mapped to OVC14 at UNI1: CoS ID is set to EI_Green_CoS1_IDs, total burst size is (1.25*CBS1 rounded up to the nearest whole frame) * BIR / (BIR-CIR1), at a rate of 1 burst every 1 second</li> <li>Tester transmits bursts of test frames mapped to OVC14 at interface not equal to ENNI1: CoS ID is set to EI_Green_CoS1_IDs. Perform the burst procedure described in section 17.3 in this document.</li> </ol>								
Expected Results	<ol style="list-style-type: none"> <li>All test frames are received at ENNI1.</li> <li>All test frames are received at ENNI1.</li> <li>The amount of traffic received at UNI1 is lower bound by N<sub>G</sub> and upper bound by N<sub>G</sub> plus half of the transmitted traffic in excess of N<sub>G</sub>. All expected test frames are received at ENNI1.</li> </ol>								
Verdict	PASS, FAIL, or INCONCLUSIVE								

14 Test Group: UNI Ingress Bandwidth Profile per CoS

14.1 UNI Ingress BWP per CoS with CIR>0, EIR=0, EBS=0, CF=0, CM=0

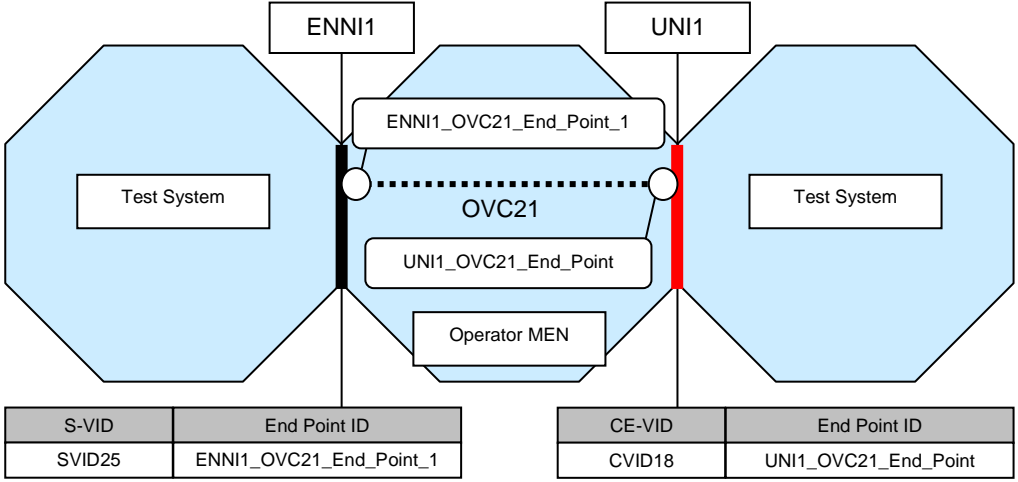
ABSTRACT TEST CASES FOR ENNI PHASE 1	
Test Case ID	UNI_INGRESS_BWP_COS.R79.1
Reference Document Source	MEF 26, R79, R82, R84
Test Status	Conditional Mandatory
Requirement	[R79] When the Ingress Bandwidth Profile per Class of Service Identifier at a UNI is in force for a given Class of Service Identifier, suitable parameters <CIR, CBS, EIR, EBS, CF, CM> as defined in Section 7.11.1 of [MEF 10.2] <b>MUST</b> be specified and the algorithm of Section 7.11.1 of [MEF 10.2] <b>MUST</b> be applied to all ingress Service Frames with the given Class of Service Identifier. [R82] CIR <b>MUST</b> be ≥ 0 [R84] EIR <b>MUST</b> be ≥ 0
Test Purpose	Verify that the UNI Ingress bandwidth profile per CoS with CIR>0 and EIR=0 and CF=0 will limit the information rate of the incoming Green traffic to CIR and drop all other frames.
Conditions	S-Tag PCP Color Indication = "Yes", Ingress Bandwidth Profile per Class of Service Identifier at UNI = "Yes"
Test Topology/OVC	
Test Procedure	<ol style="list-style-type: none"> <li>Tester transmits test frames mapped to OVC21 at UNI1: CoS ID is set to UNI_Green_CoS1_IDs, information rate is 0.5*CIR1</li> <li>Tester transmits test frames mapped to OVC21 at UNI1: CoS ID is set to UNI_Green_CoS1_IDs, information rate is (1.0-ToleranceFactor)*CIR1</li> <li>Tester transmits test frames mapped to OVC21 at UNI1: CoS ID is set to UNI_Green_CoS1_IDs, information rate is 1.5*CIR1</li> <li>Tester transmits test frames A mapped to OVC21 at UNI1: CoS ID is set to UNI_Green_CoS1_IDs, information rate is 0.5*CIR1. Tester transmits test frames B at UNI1: CoS ID is set to UNI_Yellow_CoS1_IDs, information rate is 0.1*CIR1</li> <li>Tester transmits test frames mapped to OVC21 at UNI1: CoS ID is set to UNI_Yellow_CoS1_IDs, information rate is 0.1*CIR1.</li> </ol>
Expected Results	<ol style="list-style-type: none"> <li>All test frames are received at ENNI1.</li> <li>All test frames are received at ENNI1.</li> <li>Test frames are partially received at ENNI1: In total a number of frames representing traffic of at least "Flow Transmission Duration" * (1-ToleranceFactor) * CIR1 + (CBS1 * 8) and at most "Flow Transmission Duration" * (1 + ToleranceFactor) * CIR1 + (CBS1 * 8)</li> <li>All test frames A are received at ENNI1. Test frames B are not received at any External Interface used in this test.</li> <li>Test frames are not received at any External Interface used in this test.</li> </ol>
Verdict	PASS, FAIL, or INCONCLUSIVE

14.2 UNI Ingress BWP per CoS with CIR=0, EIR>0, EBS>0, CF=0, CM=0

ABSTRACT TEST CASES FOR ENNI PHASE 1									
Test Case ID	UNI_INGRESS_BWP_COS.R79.4								
Reference Document Source	MEF 26, R79, R82, R84								
Test Status	Conditional Mandatory								
Requirement	[R79] When the Ingress Bandwidth Profile per Class of Service Identifier at a UNI is in force for a given Class of Service Identifier, suitable parameters <CIR, CBS, EIR, EBS, CF, CM> as defined in Section 7.11.1 of [MEF 10.2] <b>MUST</b> be specified and the algorithm of Section 7.11.1 of [MEF 10.2] <b>MUST</b> be applied to all ingress Service Frames with the given Class of Service Identifier. [R82] CIR <b>MUST</b> be ≥ 0 [R84] EIR <b>MUST</b> be ≥ 0								
Test Purpose	Verify that the UNI Ingress bandwidth profile per CoS with CIR=0 and EIR>0, configured in color-blind mode, will limit the total information rate of the incoming traffic to EIR and drop any excess traffic.								
Conditions	S-Tag PCP Color Indication = "Yes", Ingress Bandwidth Profile per Class of Service Identifier at UNI = "Yes"								
Test Topology/OVC	<table border="1" style="width: 100%; margin-top: 10px;"> <thead> <tr> <th>S-VID</th> <th>End Point ID</th> <th>CE-VID</th> <th>End Point ID</th> </tr> </thead> <tbody> <tr> <td>SVID28</td> <td>ENNI1_OVC24_End_Point_1</td> <td>CVID21</td> <td>UNI1_OVC24_End_Point</td> </tr> </tbody> </table>	S-VID	End Point ID	CE-VID	End Point ID	SVID28	ENNI1_OVC24_End_Point_1	CVID21	UNI1_OVC24_End_Point
S-VID	End Point ID	CE-VID	End Point ID						
SVID28	ENNI1_OVC24_End_Point_1	CVID21	UNI1_OVC24_End_Point						
Test Procedure	<ol style="list-style-type: none"> <li>Tester transmits test frames mapped to OVC24 at UNI1: CoS ID is set to UNI_Green_CoS1_IDs, information rate is 0.5*EIR1</li> <li>Tester transmits test frames mapped to OVC24 at UNI1: CoS ID is set to UNI_Green_CoS1_IDs, information rate is (1.0 – ToleranceFactor) *EIR1</li> <li>Tester transmits test frames mapped to OVC24 at UNI1: CoS ID is set to UNI_Green_CoS1_IDs, information rate is 1.5*EIR1</li> <li>Tester transmits test frames mapped to OVC24 at UNI1: CoS ID is set to UNI_Yellow_CoS1_IDs, information rate is 0.5*EIR1</li> <li>Tester transmits test frames mapped to OVC24 at UNI1: CoS ID is set to UNI_Yellow_CoS1_IDs, information rate is 1.0*EIR1</li> <li>Tester transmits test frames mapped to OVC24 at UNI1: CoS ID is set to UNI_Yellow_CoS1_IDs, information rate is 1.5*EIR1</li> <li>Tester transmits test frames A mapped to OVC24 at UNI1: CoS ID is set to UNI_Green_CoS1_IDs, information rate is 0.4*EIR1. Tester transmits test frames B mapped to OVC24 at UNI1: CoS ID is set to UNI_Yellow_CoS1_IDs, information rate is 0.4*EIR1</li> <li>Tester transmits test frames A mapped to OVC24 at UNI1: CoS ID is set to UNI_Green_CoS1_IDs, information rate is 0.5*EIR1. Tester transmits test frames B mapped to OVC24 at UNI1: CoS ID is set to UNI_Yellow_CoS1_IDs, information rate is 0.5*EIR1</li> <li>Tester transmits test frames A mapped to OVC24 at UNI1: CoS ID is set to UNI_Green_CoS1_IDs, information rate is 0.6*EIR1. Tester transmits test frames B mapped to OVC24 at UNI1: CoS ID is set to UNI_Yellow_CoS1_IDs, information rate is 0.6*EIR1</li> </ol>								

	rate is $0.6 * EIR1$
Expected Results	<ol style="list-style-type: none"> <li>1. No test frames are received at ENNI1.</li> <li>2. No test frames are received at ENNI1.</li> <li>3. No test frames are received at ENNI1: In total a number of frames representing traffic larger than zero and at most "Flow Transmission Duration" * (1 + ToleranceFactor) * EIR1 + (EBS1 * 8)</li> <li>4. More than zero test frames are received at ENNI1.</li> <li>5. More than zero test frames are received at ENNI1.</li> <li>6. More than zero test frames are received at ENNI1.</li> <li>7. No test frames A are received at ENNI1. More than zero test frames B are received at ENNI1.</li> <li>8. No test frames A are received at ENNI1. More than zero test frames B are received at ENNI1.</li> <li>9. No test frames A are received at ENNI1. More than zero test frames B are received at ENNI1.</li> </ol>
Verdict	PASS, FAIL, or INCONCLUSIVE

14.3 UNI Ingress BWP per CoS with CIR>0, EIR>0, CF=0, CM=0

ABSTRACT TEST CASES FOR ENNI PHASE 1	
Test Case ID	UNI_INGRESS_BWP_COS.R79.6
Reference Document Source	MEF 26, R79, R82, R84
Test Status	Conditional Mandatory
Requirement	[R79] When the Ingress Bandwidth Profile per Class of Service Identifier at a UNI is in force for a given Class of Service Identifier, suitable parameters <CIR, CBS, EIR, EBS, CF, CM> as defined in Section 7.11.1 of [MEF 10.2] <b>MUST</b> be specified and the algorithm of Section 7.11.1 of [MEF 10.2] <b>MUST</b> be applied to all ingress Service Frames with the given Class of Service Identifier. [R82] CIR <b>MUST</b> be ≥ 0 [R84] EIR <b>MUST</b> be ≥ 0
Test Purpose	Verify that the UNI Ingress bandwidth profile per CoS with CIR>0 and EIR>0, will limit the information rate of the incoming Green traffic to CIR, limit the sum of the excess Green traffic and the Yellow traffic to EIR and drop any excess traffic.
Conditions	S-Tag PCP Color Indication = "Yes", Ingress Bandwidth Profile per Class of Service Identifier at UNI = "Yes"
Test Topology/OVC	
Test Procedure	<ol style="list-style-type: none"> <li>1. Tester transmits test frames mapped to OVC26 at UNI1: CoS ID is set to UNI_Green_CoS1_IDs, information rate is 0.5*CIR1</li> <li>2. Tester transmits test frames mapped to OVC26 at UNI1: CoS ID is set to UNI_Green_CoS1_IDs, information rate is (1.0 - ToleranceFactor) CIR1</li> <li>3. Tester transmits test frames mapped to OVC26 at UNI1: CoS ID is set to UNI_Green_CoS1_IDs, information rate is (1.0 - ToleranceFactor) CIR1+0.5*EIR1</li> <li>4. Tester transmits test frames mapped to OVC26 at UNI1: CoS ID is set to UNI_Green_CoS1_IDs, information rate is (1.0 - ToleranceFactor) CIR1+1.0*EIR1</li> <li>5. Tester transmits test frames mapped to OVC26 at UNI1: CoS ID is set to UNI_Green_CoS1_IDs, information rate is (1.0 - ToleranceFactor) CIR1+1.5*EIR1</li> <li>6. Tester transmits test frames A mapped to OVC26 at UNI1: CoS ID is set to UNI_Green_CoS1_IDs, information rate is (1.0 - ToleranceFactor) CIR1. Tester transmits test frames B mapped to OVC26 at UNI1: CoS ID is set to UNI_Yellow_CoS1_IDs, information rate is (1.0 - ToleranceFactor) EIR1.</li> <li>7. Tester transmits test frames A mapped to OVC26 at UNI1: CoS ID is set to UNI_Green_CoS1_IDs, information rate is (1.0 - ToleranceFactor) CIR1+0.5*EIR1. Tester transmits test frames B mapped to OVC26 at UNI1: CoS ID is set to UNI_Yellow_CoS1_IDs, information rate is 0.1*EIR1.</li> <li>8. Tester transmits test frames A mapped to OVC26 at UNI1: CoS ID is set to UNI_Green_CoS1_IDs, information rate is (1.0 - ToleranceFactor) CIR1+0.5*EIR1. Tester transmits test frames B mapped to OVC26 at UNI1: CoS ID is set to UNI_Yellow_CoS1_IDs, information rate is 0.5*EIR1.</li> <li>9. Tester transmits test frames A mapped to OVC26 at UNI1: CoS ID is set to</li> </ol>

	<p>UNI_Green_CoS1_IDs, information rate is <math>(1.0 - \text{ToleranceFactor}) \text{ CIR1} + 0.6 * \text{EIR1}</math>.  Tester transmits test frames B mapped to OVC26 at UNI1: CoS ID is set to UNI_Yellow_CoS1_IDs, information rate is <math>0.6 * \text{EIR1}</math>.</p> <p>10. Tester transmits test frames A mapped to OVC26 at UNI1: CoS ID is set to UNI_Green_CoS1_IDs, information rate is <math>(1.0 - \text{ToleranceFactor}) \text{ CIR1} + 1.0 * \text{EIR1}</math>.  Tester transmits test frames B mapped to OVC26 at UNI1: CoS ID is set to UNI_Yellow_CoS1_IDs, information rate is <math>0.5 * \text{EIR1}</math>.</p> <p>11. Tester transmits test frames A mapped to OVC26 at UNI1: CoS ID is set to UNI_Green_CoS1_IDs, information rate is <math>(1.0 - \text{ToleranceFactor}) \text{ CIR1} + 1.5 * \text{EIR1}</math>.  Tester transmits test frames B mapped to OVC26 at UNI1: CoS ID is set to UNI_Yellow_CoS1_IDs, information rate is <math>0.5 * \text{EIR1}</math>.</p>
Expected Results	<ol style="list-style-type: none"> <li>1. All test frames are received at ENNI1.</li> <li>2. All test frames are received at ENNI1.</li> <li>3. All test frames are received at ENNI1.</li> <li>4. All test frames are received at ENNI1.</li> <li>5. Test frames are partially received at ENNI1: the information rate of the received test frames is at least <math>(1.0 - \text{ToleranceFactor}) * \text{CIR1}</math>.</li> <li>6. All test frames A are received at ENNI1. More than zero test frames B are received at ENNI1.</li> <li>7. A number of test frames A representing traffic of least “Flow Transmission Duration” * <math>(1 - \text{ToleranceFactor}) * \text{CIR1} + (\text{CBS1} * 8)</math> are received at ENNI1. More than zero test frames B are received at ENNI1.</li> <li>8. A number of test frames A representing traffic of least “Flow Transmission Duration” * <math>(1 - \text{ToleranceFactor}) * \text{CIR1} + (\text{CBS1} * 8)</math> are received at ENNI1. More than zero test frames B are received at ENNI1.</li> <li>9. A number of test frames A representing traffic of least “Flow Transmission Duration” * <math>(1 - \text{ToleranceFactor}) * \text{CIR1} + (\text{CBS1} * 8)</math> are received at ENNI1. More than zero test frames B are received at ENNI1.</li> <li>10. A number of test frames A representing traffic of least “Flow Transmission Duration” * <math>(1 - \text{ToleranceFactor}) * \text{CIR1} + (\text{CBS1} * 8)</math> are received at ENNI1. More than zero test frames B are received at ENNI1.</li> <li>11. A number of test frames A representing traffic of least “Flow Transmission Duration” * <math>(1 - \text{ToleranceFactor}) * \text{CIR1} + (\text{CBS1} * 8)</math> are received at ENNI1. More than zero test frames B are received at ENNI1.</li> </ol>
Verdict	PASS, FAIL, or INCONCLUSIVE

14.4 UNI Ingress BWP per CoS: Committed Burst Size, EBS = 0.

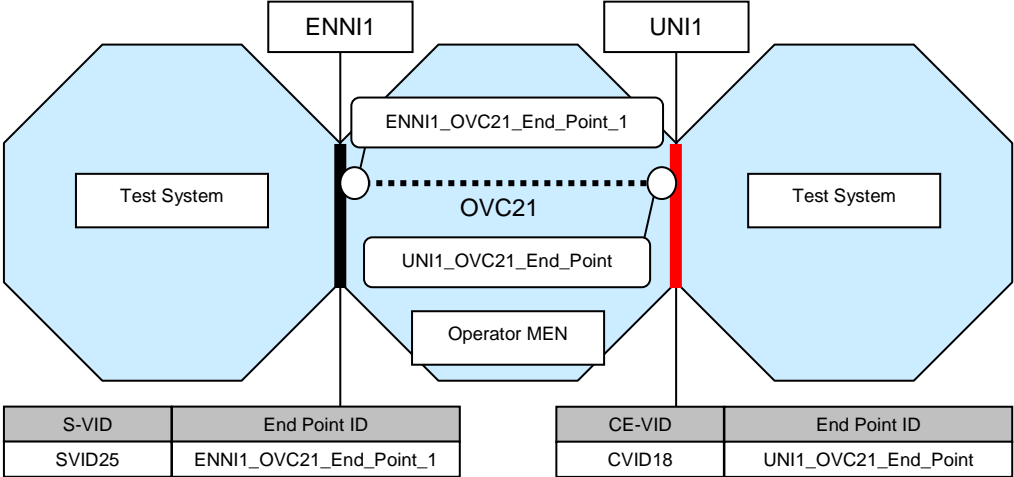
ABSTRACT TEST CASES FOR ENNI PHASE 1	
Test Case ID	UNI_INGRESS_BWP_COS.R79.8
Reference Document Source	MEF 26, R79, R83
Test Status	Conditional Mandatory
Requirement	[R79] When the Ingress Bandwidth Profile per Class of Service Identifier at a UNI is in force for a given Class of Service Identifier, suitable parameters <CIR, CBS, EIR, EBS, CF, CM> as defined in Section 7.11.1 of [MEF 10.2] <b>MUST</b> be specified and the algorithm of Section 7.11.1 of [MEF 10.2] <b>MUST</b> be applied to all ingress Service Frames with the given Class of Service Identifier. [R83] When CIR > 0, CBS <b>MUST</b> be greater than or equal to the largest Maximum Transmission Unit size allowed for the ENNI Frames that the Bandwidth Profile applies to.
Test Purpose	Verify that UNI Ingress bandwidth profile per CoS with CIR>0 will forward bursts of Green traffic of at least MTU size and at most CBS size.
Conditions	S-Tag PCP Color Indication = "Yes", Ingress Bandwidth Profile per Class of Service Identifier at UNI = "Yes"
Test Topology/OVC	
Test Procedure	<ol style="list-style-type: none"> <li>1. Tester transmits bursts of test frames mapped to OVC21 at UNI1: CoS ID is set to UNI_Green_CoS1_IDs, total burst size is <math>0.5 * CBS1</math> octets, at a rate of 1 burst every 1 second</li> <li>2. Tester transmits bursts of test frames mapped to OVC21 at UNI1: CoS ID is set to UNI_Green_CoS1_IDs, total burst size is <math>1.0 * CBS1</math> octets rounded down to the next whole frame, at a rate of 1 burst every 1 second</li> <li>3. Tester transmits bursts of test frames mapped to OVC21 at UNI1: CoS ID is set to UNI_Green_CoS1_IDs, total burst size is <math>(1.25 * CBS1 \text{ rounded up to the nearest whole frame}) * BIR / (BIR - CIR1)</math>, at a rate of 1 burst every 1 second</li> <li>4. Tester transmits bursts of test frames mapped to OVC21 at UNI1: CoS ID is set to UNI_Green_CoS1_IDs. Perform the burst procedure described in section 17.3 in this document)</li> </ol>
Expected Results	<ol style="list-style-type: none"> <li>1. All test frames are received at ENNI1.</li> <li>2. All test frames are received at ENNI1.</li> <li>3.</li> <li>4. The amount of traffic received at ENNI1 is lower bound by <math>N_G</math> and upper bound by <math>N_G</math> plus half of the transmitted traffic in excess of <math>N_G</math>. All expected test frames are received at ENNI1.</li> </ol>
Verdict	PASS, FAIL, or INCONCLUSIVE

14.5 UNI Ingress BWP per CoS: Excess Burst Size.

ABSTRACT TEST CASES FOR ENNI PHASE 1									
Test Case ID	UNI_INGRESS_BWP_COS.R79.9								
Reference Document Source	MEF 26, R79, R85								
Test Status	Conditional Mandatory								
Requirement	[R79] When the Ingress Bandwidth Profile per Class of Service Identifier at a UNI is in force for a given Class of Service Identifier, suitable parameters <CIR, CBS, EIR, EBS, CF, CM> as defined in Section 7.11.1 of [MEF 10.2] <b>MUST</b> be specified and the algorithm of Section 7.11.1 of [MEF 10.2] <b>MUST</b> be applied to all ingress Service Frames with the given Class of Service Identifier. [R85] When EIR > 0, EBS <b>MUST</b> be greater than or equal to the largest Maximum Transmission Unit size allowed for the ENNI Frames that the Bandwidth Profile applies to.								
Test Purpose	Verify that UNI Ingress bandwidth profile per CoS with CIR>0 will forward bursts of Yellow traffic of at least MTU size and at most EBS size.								
Conditions	S-Tag PCP Color Indication = "Yes", Ingress Bandwidth Profile per Class of Service Identifier at UNI = "Yes"								
Test Topology/OVC	<table border="1" style="margin-top: 10px;"> <thead> <tr> <th>S-VID</th> <th>End Point ID</th> </tr> </thead> <tbody> <tr> <td>SVID28</td> <td>ENNI1_OVC24_End_Point_1</td> </tr> </tbody> </table> <table border="1" style="margin-top: 10px;"> <thead> <tr> <th>CE-VID</th> <th>End Point ID</th> </tr> </thead> <tbody> <tr> <td>CVID21</td> <td>UNI1_OVC24_End_Point</td> </tr> </tbody> </table>	S-VID	End Point ID	SVID28	ENNI1_OVC24_End_Point_1	CE-VID	End Point ID	CVID21	UNI1_OVC24_End_Point
S-VID	End Point ID								
SVID28	ENNI1_OVC24_End_Point_1								
CE-VID	End Point ID								
CVID21	UNI1_OVC24_End_Point								
Test Procedure	<ol style="list-style-type: none"> <li>1. Tester transmits bursts of test frames mapped to OVC24 at UNI1: CoS ID is set to UNI_Yellow_CoS1_IDs, total burst size is 0.5*EBS1 octets, at a rate of 1 burst every 1 second</li> <li>2. Tester transmits bursts of test frames mapped to OVC24 at UNI1: CoS ID is set to UNI_Yellow_CoS1_IDs, total burst size is 1.0*EBS1 octets, at a rate of 1 burst every 1 second</li> <li>3. Tester transmits bursts of test frames mapped to OVC24 test frames at UNI1: CoS ID is set to UNI_Yellow_CoS1_IDs. Perform the burst procedure described in section 17.4 in this document.</li> </ol>								
Expected Results	<ol style="list-style-type: none"> <li>1. More than zero test frames are received at ENNI1.</li> <li>2. More than zero test frames are received at ENNI1.</li> <li>3. All green test frames are received at ENNI1, and more than zero yellow frames are received.</li> </ol>								
Verdict	PASS, FAIL, or INCONCLUSIVE								

15 Test Group: UNI Egress Bandwidth Profile per CoS

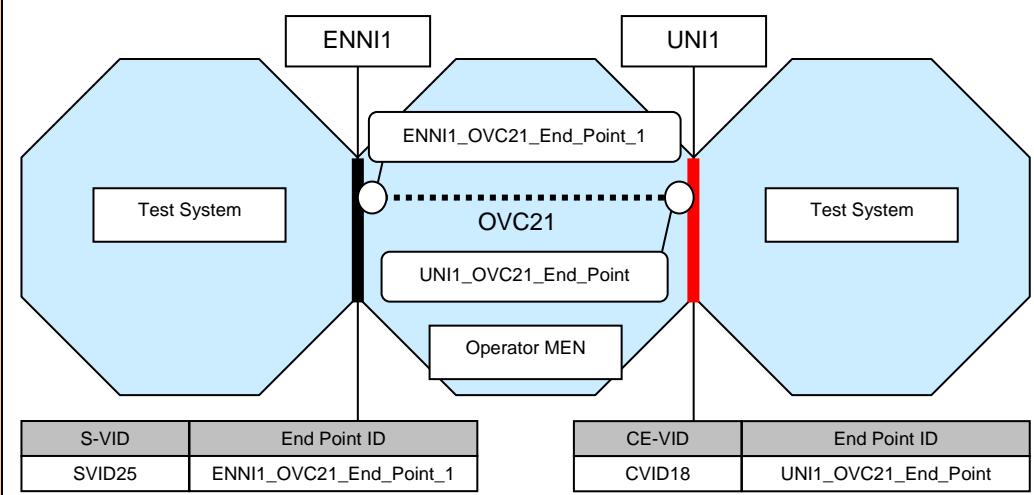

15.1 UNI Egress BWP per CoS with CIR>0, EIR=0, EBS= 0, CF=0, CM=0

ABSTRACT TEST CASES FOR ENNI PHASE 1	
Test Case ID	UNI_EGRESS_BWP_COS.R81.1
Reference Document Source	MEF 26, R81, R82, R84
Test Status	Conditional Mandatory
Requirement	<p>[R81] When the Egress Bandwidth Profile per Class of Service Identifier at a UNI is in force for a given Class of Service Identifier, suitable parameters &lt;CIR, CBS, EIR, EBS, CF, CM&gt; as defined in Section 7.11.1 of [MEF 10.2] MUST be specified and when the algorithm of Section 7.11.1 of [MEF 10.2] using these parameters is applied to these egress Service Frames, the result for each Service Frame MUST be to declare the Service Frame either Green or Yellow.</p> <p>[R82] CIR <b>MUST</b> be <math>\geq 0</math></p> <p>[R84] EIR <b>MUST</b> be <math>\geq 0</math></p>
Test Purpose	Verify that the UNI Egress bandwidth profile per CoS with CIR>0 and EIR=0 and CF=0 will limit the information rate of the incoming Green traffic to CIR and drop all other frames.
Conditions	S-Tag PCP Color Indication = "Yes", Egress Bandwidth Profile per Class of Service Identifier at UNI = "Yes"
Test Topology/OVC	
Test Procedure	<ol style="list-style-type: none"> <li>Tester transmits test frames at ENNI1 that are mapped to OVC21: CoS ID is set to ENNI_Green_CoS1_IDs, information rate is <math>0.5 * CIR1</math></li> <li>Tester transmits test frames at ENNI1 that are mapped to OVC21: CoS ID is set to ENNI_Green_CoS1_IDs, information rate is <math>1.0 * CIR1</math></li> <li>Tester transmits test frames at ENNI1 that are mapped to OVC21: CoS ID is set to ENNI_Green_CoS1_IDs, information rate is <math>1.5 * CIR1</math></li> <li>Tester transmits test frames A at ENNI1 that are mapped to OVC21: CoS ID is set to ENNI_Green_CoS1_IDs, information rate is <math>0.5 * CIR1</math>. Tester transmits test frames B at ENNI1 that are mapped to OVC21: CoS ID is set to ENNI_Yellow_CoS1_IDs, information rate is <math>0.1 * CIR1</math></li> <li>Tester transmits test frames at ENNI1 that are mapped to OVC21: CoS ID is set to ENNI_Yellow_CoS1_IDs, information rate is <math>0.1 * CIR1</math>.</li> </ol>
Expected Results	<ol style="list-style-type: none"> <li>All test frames are received at UNI1.</li> <li>All test frames are received at UNI1.</li> <li>Test frames are partially received at UNI1: the information rate of the received test frames is at least <math>(1.0 - ToleranceFactor) * CIR1</math>.</li> <li>All test frames A are received at UNI1. Test frames B are not received at any External Interface.</li> <li>Test frames are not received at any External Interface used in this test.</li> </ol>
Verdict	PASS, FAIL, or INCONCLUSIVE

15.2 UNI Egress BWP per CoS with CIR=0, EIR>0, CF=0, CM=0

ABSTRACT TEST CASES FOR ENNI PHASE 1									
Test Case ID	UNI_EGRESS_BWP_COS.R81.4								
Reference Document Source	MEF 26, R81, R82, R84								
Test Status	Conditional Mandatory								
Requirement	<p>[R81] When the Egress Bandwidth Profile per Class of Service Identifier at a UNI is in force for a given Class of Service Identifier, suitable parameters &lt;CIR, CBS, EIR, EBS, CF, CM&gt; as defined in Section 7.11.1 of [MEF 10.2] MUST be specified and when the algorithm of Section 7.11.1 of [MEF 10.2] using these parameters is applied to these egress Service Frames, the result for each Service Frame MUST be to declare the Service Frame either Green or Yellow.</p> <p>[R82] CIR <b>MUST</b> be <math>\geq 0</math></p> <p>[R84] EIR <b>MUST</b> be <math>\geq 0</math></p>								
Test Purpose	Verify that the UNI Egress bandwidth profile per CoS with CIR=0 and EIR>0, configured in color-blind mode, will limit the total information rate of the incoming traffic to EIR and drop any excess traffic.								
Conditions	S-Tag PCP Color Indication = "Yes", Egress Bandwidth Profile per Class of Service Identifier at UNI = "Yes"								
Test Topology/OVC	<table border="1" style="width: 100%; margin-top: 10px;"> <tr> <td style="width: 50%;">S-VID</td> <td style="width: 50%;">End Point ID</td> <td style="width: 50%;">CE-VID</td> <td style="width: 50%;">End Point ID</td> </tr> <tr> <td>SVID28</td> <td>ENNI1_OVC24_End_Point_1</td> <td>CVID21</td> <td>UNI1_OVC24_End_Point</td> </tr> </table>	S-VID	End Point ID	CE-VID	End Point ID	SVID28	ENNI1_OVC24_End_Point_1	CVID21	UNI1_OVC24_End_Point
S-VID	End Point ID	CE-VID	End Point ID						
SVID28	ENNI1_OVC24_End_Point_1	CVID21	UNI1_OVC24_End_Point						
Test Procedure	<ol style="list-style-type: none"> <li>Tester transmits test frames at ENNI1 that are mapped to OVC24: CoS ID is set to ENNI_Green_CoS1_IDs, information rate is <math>0.5 * EIR1</math></li> <li>Tester transmits test frames at ENNI1 that are mapped to OVC24: CoS ID is set to ENNI_Green_CoS1_IDs, information rate is <math>(1.0 - \text{ToleranceFactor}) * EIR1</math></li> <li>Tester transmits test frames at ENNI1 that are mapped to OVC24: CoS ID is set to ENNI_Green_CoS1_IDs, information rate is <math>1.5 * EIR1</math></li> <li>Tester transmits test frames at ENNI1 that are mapped to OVC24: CoS ID is set to ENNI_Yellow_CoS1_IDs, information rate is <math>0.5 * EIR1</math></li> <li>Tester transmits test frames at ENNI1 that are mapped to OVC24: CoS ID is set to ENNI_Yellow_CoS1_IDs, information rate is <math>(1.0 - \text{ToleranceFactor}) * EIR1</math></li> <li>Tester transmits test frames at ENNI1 that are mapped to OVC24: CoS ID is set to ENNI_Yellow_CoS1_IDs, information rate is <math>1.5 * EIR1</math></li> <li>Tester transmits test frames A at ENNI1 that are mapped to OVC24: CoS ID is set to ENNI_Green_CoS1_IDs, information rate is <math>0.4 * EIR1</math>. Tester transmits test frames B at ENNI1 that are mapped to OVC24: CoS ID is set to ENNI_Yellow_CoS1_IDs, information rate is <math>0.4 * EIR1</math></li> <li>Tester transmits test frames A at ENNI1 that are mapped to OVC24: CoS ID is set to ENNI_Green_CoS1_IDs, information rate is <math>0.5 * EIR1</math>. Tester transmits test frames B at ENNI1 that are mapped to OVC24: CoS ID is set to ENNI_Yellow_CoS1_IDs, information rate is <math>0.5 * EIR1</math></li> <li>Tester transmits test frames A at ENNI1 that are mapped to OVC24: CoS ID is set to ENNI_Green_CoS1_IDs, information rate is <math>0.6 * EIR1</math>. Tester transmits test frames</li> </ol>								

	B at ENNI1 that are mapped to OVC24: CoS ID is set to ENNI_Yellow_CoS1_IDs, information rate is $0.6 * EIR1$
Expected Results	<ol style="list-style-type: none"> <li>1. More than zero test frames are received at UNI1.</li> <li>2. More than zero test frames are received at UNI1.</li> <li>3. More than zero test frames are received at UNI1.</li> <li>4. More than zero test frames are received at UNI1.</li> <li>5. More than zero test frames are received at UNI1.</li> <li>6. More than zero test frames are received at UNI1.</li> <li>7. More than zero test frames (A + B) in an arbitrary combination are received at UNI1.</li> <li>8. More than zero test frames (A + B) in an arbitrary combination are received at UNI1.</li> <li>9. More than zero test frames (A + B) are received in an arbitrary combination at UNI1.</li> </ol>
Verdict	PASS, FAIL, or INCONCLUSIVE

15.3 UNI Egress BWP per CoS with CIR>0, EIR>0, CF=0

ABSTRACT TEST CASES FOR ENNI PHASE 1									
Test Case ID	UNI_EGRESS_BWP_COS.R81.6								
Reference Document Source	MEF 26, R81, R82, R84								
Test Status	Conditional Mandatory								
Requirement	<p>[R81] When the Egress Bandwidth Profile per Class of Service Identifier at a UNI is in force for a given Class of Service Identifier, suitable parameters &lt;CIR, CBS, EIR, EBS, CF, CM&gt; as defined in Section 7.11.1 of [MEF 10.2] MUST be specified and when the algorithm of Section 7.11.1 of [MEF 10.2] using these parameters is applied to these egress Service Frames, the result for each Service Frame MUST be to declare the Service Frame either Green or Yellow.</p> <p>[R82] CIR <b>MUST</b> be <math>\geq 0</math></p> <p>[R84] EIR <b>MUST</b> be <math>\geq 0</math></p>								
Test Purpose	Verify that the UNI Egress bandwidth profile per CoS with CIR>0 and EIR>0, will limit the information rate of the incoming Green traffic to CIR, limit the sum of the excess Green traffic and the Yellow traffic to EIR and drop any excess traffic.								
Conditions	S-Tag PCP Color Indication = "Yes", Egress Bandwidth Profile per Class of Service Identifier at UNI = "Yes"								
Test Topology/OVC	<table border="1" style="width: 100%; margin-top: 10px;"> <thead> <tr> <th>S-VID</th> <th>End Point ID</th> <th>CE-VID</th> <th>End Point ID</th> </tr> </thead> <tbody> <tr> <td>SVID30</td> <td>ENNI1_OVC26_End_Point_1</td> <td>CVID23</td> <td>UNI1_OVC26_End_Point</td> </tr> </tbody> </table>	S-VID	End Point ID	CE-VID	End Point ID	SVID30	ENNI1_OVC26_End_Point_1	CVID23	UNI1_OVC26_End_Point
S-VID	End Point ID	CE-VID	End Point ID						
SVID30	ENNI1_OVC26_End_Point_1	CVID23	UNI1_OVC26_End_Point						
Test Procedure	<ol style="list-style-type: none"> <li>Tester transmits test frames at ENNI1 that are mapped to OVC26: CoS ID is set to ENNI_Green_CoS1_IDs, information rate is <math>0.5 * CIR1</math></li> <li>Tester transmits test frames at ENNI1 that are mapped to OVC26: CoS ID is set to ENNI_Green_CoS1_IDs, information rate is <math>(1.0 - ToleranceFactor) CIR1</math></li> <li>Tester transmits test frames at ENNI1 that are mapped to OVC26: CoS ID is set to ENNI_Green_CoS1_IDs, information rate is <math>(1.0 - ToleranceFactor) CIR1 + 0.5 * EIR1</math></li> <li>Tester transmits test frames at ENNI1 that are mapped to OVC26: CoS ID is set to ENNI_Green_CoS1_IDs, information rate is <math>(1.0 - ToleranceFactor) CIR1 + 1.0 * EIR1</math></li> <li>Tester transmits test frames at ENNI1 that are mapped to OVC26: CoS ID is set to ENNI_Green_CoS1_IDs, information rate is <math>(1.0 - ToleranceFactor) CIR1 + 1.5 * EIR1</math></li> <li>Tester transmits test frames A at ENNI1 that are mapped to OVC26: CoS ID is set to ENNI_Green_CoS1_IDs, information rate is <math>(1.0 - ToleranceFactor) CIR1</math>. Tester transmits test frames B at ENNI1 that are mapped to OVC26: CoS ID is set to ENNI_Yellow_CoS1_IDs, information rate is <math>(1.0 - ToleranceFactor) EIR1</math>.</li> <li>Tester transmits test frames A at ENNI1 that are mapped to OVC26: CoS ID is set to ENNI_Green_CoS1_IDs, information rate is <math>(1.0 - ToleranceFactor) CIR1 + 0.5 * EIR1</math>. Tester transmits test frames B at ENNI1 that are mapped to OVC26: CoS ID is set to ENNI_Yellow_CoS1_IDs, information rate is <math>0.1 * EIR1</math>.</li> <li>Tester transmits test frames A at ENNI1 that are mapped to OVC26: CoS ID is set to ENNI_Green_CoS1_IDs, information rate is <math>(1.0 - ToleranceFactor) CIR1 + 0.5 * EIR1</math>. Tester transmits test frames B at ENNI1 that are mapped to OVC26: CoS ID is set to ENNI_Yellow_CoS1_IDs, information rate is <math>0.5 * EIR1</math>.</li> </ol>								

	<ol style="list-style-type: none"> <li>9. Tester transmits test frames A at ENNI1 that are mapped to OVC26: CoS ID is set to ENNI_Green_CoS1_IDs, information rate is <math>(1.0 - \text{ToleranceFactor}) \text{ CIR1} + 0.6 * \text{EIR1}</math>. Tester transmits test frames B at ENNI1 that are mapped to OVC26: CoS ID is set to ENNI_Yellow_CoS1_IDs, information rate is <math>0.6 * \text{EIR1}</math>.</li> <li>10. Tester transmits test frames A at ENNI1 that are mapped to OVC26: CoS ID is set to ENNI_Green_CoS1_IDs, information rate is <math>(1.0 - \text{ToleranceFactor}) \text{ CIR1} + 1.0 * \text{EIR1}</math>. Tester transmits test frames A at ENNI1 that are mapped to OVC26: CoS ID is set to ENNI_Yellow_CoS1_IDs, information rate is <math>0.5 * \text{EIR1}</math>.</li> <li>11. Tester transmits test frames A at ENNI1 that are mapped to OVC26: CoS ID is set to ENNI_Green_CoS1_IDs, information rate is <math>(1.0 - \text{ToleranceFactor}) \text{ CIR1} + 1.5 * \text{EIR1}</math>. Tester transmits test frames B at ENNI1 that are mapped to OVC26: CoS ID is set to ENNI_Yellow_CoS1_IDs, information rate is <math>0.5 * \text{EIR1}</math>.</li> </ol>
Expected Results	<ol style="list-style-type: none"> <li>1. All test frames are received at UNI1.</li> <li>2. All test frames are received at UNI1.</li> <li>3. All test frames are received at UNI1.</li> <li>4. All test frames are received at UNI1.</li> <li>5. Test frames are partially received at UNI1: the information rate of the received test frames is at least <math>(1.0 - \text{ToleranceFactor}) * \text{CIR1}</math>.</li> <li>6. All test frames A are received at UNI1. More than zero test frames B are received at UNI1.</li> <li>7. A number of test frames A representing traffic of least “Flow Transmission Duration” * <math>(1 - \text{ToleranceFactor}) * \text{CIR1} + (\text{CBS1} * 8)</math> are received at UNI1. More than zero test frames B are received at UNI1.</li> <li>8. A number of test frames A representing traffic of least “Flow Transmission Duration” * <math>(1 - \text{ToleranceFactor}) * \text{CIR1} + (\text{CBS1} * 8)</math> are received at UNI1. More than zero test frames B are received at UNI1.</li> <li>9. A number of test frames A representing traffic of least “Flow Transmission Duration” * <math>(1 - \text{ToleranceFactor}) * \text{CIR1} + (\text{CBS1} * 8)</math> are received at UNI1. More than zero test frames B are received at UNI1.</li> <li>10. A number of test frames A representing traffic of least “Flow Transmission Duration” * <math>(1 - \text{ToleranceFactor}) * \text{CIR1} + (\text{CBS1} * 8)</math> are received at UNI1. More than zero test frames B are received at UNI1.</li> <li>11. A number of test frames A representing traffic of least “Flow Transmission Duration” * <math>(1 - \text{ToleranceFactor}) * \text{CIR1} + (\text{CBS1} * 8)</math> are received at UNI1. More than zero test frames B are received at UNI1.</li> </ol>
Verdict	PASS, FAIL, or INCONCLUSIVE

15.4 UNI Egress BWP per CoS: Committed Burst Size, EBS = 0

ABSTRACT TEST CASES FOR ENNI PHASE 1									
Test Case ID	UNI_EGRESS_BWP_COS.R81.8								
Reference Document Source	MEF 26, R81, R83								
Test Status	Conditional Mandatory								
Requirement	<p>[R81] When the Egress Bandwidth Profile per Class of Service Identifier at a UNI is in force for a given Class of Service Identifier, suitable parameters &lt;CIR, CBS, EIR, EBS, CF, CM&gt; as defined in Section 7.11.1 of [MEF 10.2] MUST be specified and when the algorithm of Section 7.11.1 of [MEF 10.2] using these parameters is applied to these egress Service Frames, the result for each Service Frame MUST be to declare the Service Frame either Green or Yellow.</p> <p>[R83] When CIR &gt; 0, CBS MUST be greater than or equal to the largest Maximum Transmission Unit size allowed for the ENNI Frames that the Bandwidth Profile applies to.</p>								
Test Purpose	Verify that UNI Egress bandwidth profile per CoS with CIR>0 will forward bursts of Green traffic of at least MTU size and at most CBS size.								
Conditions	S-Tag PCP Color Indication = "Yes", Egress Bandwidth Profile per Class of Service Identifier at UNI = "Yes"								
Test Topology/OVC	<table border="1" style="margin-top: 10px;"> <thead> <tr> <th>S-VID</th> <th>End Point ID</th> <th>CE-VID</th> <th>End Point ID</th> </tr> </thead> <tbody> <tr> <td>SVID25</td> <td>ENNI1_OVC21_End_Point_1</td> <td>CVID18</td> <td>UNI1_OVC21_End_Point</td> </tr> </tbody> </table>	S-VID	End Point ID	CE-VID	End Point ID	SVID25	ENNI1_OVC21_End_Point_1	CVID18	UNI1_OVC21_End_Point
S-VID	End Point ID	CE-VID	End Point ID						
SVID25	ENNI1_OVC21_End_Point_1	CVID18	UNI1_OVC21_End_Point						
Test Procedure	<ol style="list-style-type: none"> <li>Tester transmits bursts of test frames at ENNI1 that are mapped to OVC21: CoS ID is set to ENNI_Green_CoS1_IDs, total burst size is 0.5*CBS1 octets, at a rate of 1 burst every 1 second</li> <li>Tester transmits bursts of test frames at ENNI1 that are mapped to OVC21: CoS ID is set to ENNI_Green_CoS1_IDs, total burst size is 1.0*CBS1 octets rounded down to the next whole frame, at a rate of 1 burst every 1 second</li> <li>Tester transmits bursts of test frames at ENNI1 that are mapped to OVC21: CoS ID is set to ENNI_Green_CoS1_IDs, total burst size is (1.25*CBS1 rounded up to the nearest whole frame) * BIR / (BIR-CIR1), at a rate of 1 burst every 1 second</li> <li>Tester transmits bursts of test frames at ENNI1 that are mapped to OVC21: CoS ID is set to ENNI_Green_CoS1_IDs. Perform the burst described in section 17.3 in this document.</li> </ol>								
Expected Results	<ol style="list-style-type: none"> <li>All test frames are received at UNI1.</li> <li>All test frames are received at UNI1.</li> <li>The amount of traffic received at ENNI1 is lower bound by N<sub>G</sub> and upper bound by N<sub>G</sub> plus half of the transmitted traffic in excess of N<sub>G</sub>.</li> <li>All expected test frames are received at UNI1.</li> </ol>								
Verdict	PASS, FAIL, or INCONCLUSIVE								

15.5 UNI Egress BWP per CoS: Excess Burst Size

ABSTRACT TEST CASES FOR ENNI PHASE 1									
Test Case ID	UNI_EGRESS_BWP_COS.R81.9								
Reference Document Source	MEF 26, R81, R85								
Test Status	Conditional Mandatory								
Requirement	<p>[R81] When the Egress Bandwidth Profile per Class of Service Identifier at a UNI is in force for a given Class of Service Identifier, suitable parameters &lt;CIR, CBS, EIR, EBS, CF, CM&gt; as defined in Section 7.11.1 of [MEF 10.2] MUST be specified and when the algorithm of Section 7.11.1 of [MEF 10.2] using these parameters is applied to these egress Service Frames, the result for each Service Frame MUST be to declare the Service Frame either Green or Yellow.</p> <p>[R85] When EIR &gt; 0, EBS MUST be greater than or equal to the largest Maximum Transmission Unit size allowed for the ENNI Frames that the Bandwidth Profile applies to.</p>								
Test Purpose	Verify that UNI Egress bandwidth profile per CoS with CIR>0 will forward bursts of Yellow traffic of at least MTU size and at most EBS size.								
Conditions	S-Tag PCP Color Indication = "Yes", Egress Bandwidth Profile per Class of Service Identifier at UNI = "Yes"								
Test Topology/OVC	<table border="1" style="width: 100%; margin-top: 10px;"> <thead> <tr> <th>S-VID</th> <th>End Point ID</th> <th>CE-VID</th> <th>End Point ID</th> </tr> </thead> <tbody> <tr> <td>SVID28</td> <td>ENNI1_OVC24_End_Point_1</td> <td>CVID21</td> <td>UNI1_OVC24_End_Point</td> </tr> </tbody> </table>	S-VID	End Point ID	CE-VID	End Point ID	SVID28	ENNI1_OVC24_End_Point_1	CVID21	UNI1_OVC24_End_Point
S-VID	End Point ID	CE-VID	End Point ID						
SVID28	ENNI1_OVC24_End_Point_1	CVID21	UNI1_OVC24_End_Point						
Test Procedure	<ol style="list-style-type: none"> <li>Tester transmits bursts of test frames at ENNI1 that are mapped to OVC24: CoS ID is set to ENNI_Yellow_CoS1_IDs, total burst size is 0.5*EBS1 octets, at a rate of 1 burst every 1 second</li> <li>Tester transmits bursts of test frames at ENNI1 that are mapped to OVC24: CoS ID is set to ENNI_Yellow_CoS1_IDs, total burst size is 1.0*EBS1 octets, at a rate of 1 burst every 1 second</li> <li>Tester transmits bursts of test frames at ENNI1 that are mapped to OVC24: CoS ID is set to ENNI_Yellow_CoS1_IDs. Perform the burst procedure described in section 17.4 in this document.</li> </ol>								
Expected Results	<ol style="list-style-type: none"> <li>More than zero test frames are received at UNI1.</li> <li>More than zero test frames are received at UNI1.</li> <li>All expected green test frames are received at UNI1, and more than zero yellow frames are received.</li> </ol>								
Verdict	PASS, FAIL, or INCONCLUSIVE								

## 16 References

- [MEF 26] External Network Network (ENNI) – Phase 1, including MEF26.0.1 and MEF26.0.2 updates
- [MEF 12.1] Carrier Ethernet Network Architecture Framework, Part 2: Ethernet Services Layer - Base Elements
- [802.3 – 2005] IEEE 802.3 – 2005 Information technology – Telecommunications and information exchange between systems – Local and metropolitan area networks – Specific requirements – Part 3: Carrier sense multiple access with collision detection (CSMA/CD) access method and physical layer specifications, 8 December 2005.
- [802.1ad – 2005] IEEE 802.1ad – 2005 IEEE Standard for Local and metropolitan Area Networks – Virtual Bridged Local Area Networks Amendment 4: Provider Bridges, May 2005.
- [MEF 10.2] Ethernet Services Attributes Phase 2, MEF 10.2
- [MEF 9] Abstract Test Suite for Ethernet Services at the UNI, MEF 9
- [MEF 6.1] Ethernet Services Definitions - Phase 2, MEF 6.1
- [RFC 2119] "Key words for use in RFCs to Indicate Requirement Levels", S. Bradner, <http://www.ietf.org/rfc/rfc2119.txt> (Normative)
- [RFC 2285] "Benchmarking Terminology for LAN Switching Devices", R. Mandeville, <http://www.ietf.org/rfc/rfc2285.txt>
- [MEF 23] Carrier Ethernet Class of Service – Phase 1, MEF 23
- [MEF 17] Service OAM Requirements & Framework – Phase 1, MEF 17
- [ISO9646] OSI Conformance testing methodology and framework, ISO/IEC 9646-1
- [802.1ag – 2007] IEEE Standard for Local and metropolitan Area Networks – Virtual Bridged Local Area Networks Amendment 5: Connectivity Fault Management, December 2007, IEEE Std 802.1ag – 2007
- [RFC 2544] Benchmarking Methodology for Network Interconnect Devices, S. Bradner, J. McQuaid, <http://www.ietf.org/rfc/rfc2544.txt>
- [RFC 2889] Benchmarking Methodology for LAN Switching Devices, R. Mandeville, J. Perser, <http://www.ietf.org/rfc/rfc2889.txt>

## 17 Appendix



## 17.1 Table of Requirements Derived from the ENNI Specification

The test cases in this document are derived from the requirements of the MEF 26 specification ([MEF 26]). Not every requirement specified in the [MEF 26] can be translated into test cases, for example, as, some requirements specify contractual obligations. Such requirements are marked in the table below as not applicable. The table also represents a creation status of conformance test cases for that requirement ("Done", or "Planned"). The "Done" status means, that at least one test case is fully specified for the requirement. The "Planned" status means the requirement is applicable, and there are no test cases specified yet for that requirement. The creation status and type are only meaningful if the requirement is applicable.

The Abstract Test Suite for ENNI is split in to two parts: Level 1 and Level 2 ATS. The column ATS Part identifies the mapping of the requirement to the ENNI ATS part and the test group. This document includes test cases of Level 1 ATS only.

**Table 133: Table of requirements**

Req. ID	Requirement	Applicable	Creation Status	ATS Part/ATS Group
<b>R1</b>	When there are two physical links in the ENNI, an ENNI-Ni MUST be capable of implementing Link Aggregation as in Clause 43.6.1 of [802.3 – 2005] with one Link Aggregation Group (LAG) across the ports supporting an instance of ENNI and with one link in active mode and the other in standby mode.	Yes	Done	Level 1/ Protection
<b>R2</b>	When Link Aggregation is used at the ENNI, LACP MUST be used by each ENNI-Ni per [802.3 – 2005].	Yes	Done	Level 1/ Protection
<b>R3</b>	The Operator ENNI Identifier MUST be unique among all such identifiers for ENNIs supported by the Operator MEN.	No	Done	N/A
<b>R4</b>	The Operator ENNI Identifier MUST contain no more than 45 bytes.	No	Done	N/A
<b>R5</b>	Each link in an ENNI MUST be one of the following physical layers in full duplex mode as defined in [IEEE 802.3 – 2005]: 1000Base-SX, 1000Base-LX, 1000Base T, 10GBASE-SR, 10GBASE-LX4, 10GBASE-LR, 10GBASE-ER, 10GBASE-SW, 10GBASE-LW, 10GBASE-EW.	Yes	Done	Level 1/ Foundation
<b>R6</b>	Each ENNI Frame MUST have the standard Ethernet format with one of the tag configurations specified in Table 3 of [MEF 26]. [DA = Destination Address, SA = Source Address, ET = Ethertype/Length, S-Tag with Tag Protocol Identification Field (TPID) = 0x88A8, C-Tag with TPID = 0x8100.]	Yes	Done	Level 1/ Foundation
<b>R7</b>	An S-Tag MUST have the format specified in Sections 9.5 and 9.7 of [IEEE 802.1ad].	Yes	Done	Level 1/ Foundation
<b>R8</b>	A C-Tag MUST have the format specified in Sections 9.5 and 9.6 of [IEEE 802.1ad].	Yes	Done	Level 1/ Foundation
<b>R9</b>	An ingress ENNI Frame that is invalid as defined in Clause 3.4 of [802.3 – 2005] MUST be discarded by the receiving Operator MEN.	Yes	Done	Level 1/ Foundation
<b>R10</b>	An ingress ENNI Frame whose length is less than 64 octets MUST be discarded by the receiving Operator MEN as per Clause 4.2.4.2.2 of [802.3 – 2005].	Yes	Done	Level 1/ Foundation
<b>R11</b>	If the Number of Links is one, then the Protection Mechanism attribute MUST be set to "none."	No	Done	N/A

Req. ID	Requirement	Applicable	Creation Status	ATS Part/ATS Group
<b>R12</b>	If the Number of Links is 2 and LAG as specified in [R1] is implemented, then the Protection Mechanism attribute MUST be set to "Link Aggregation."	No	Done	N/A
<b>R13</b>	If the conditions specified [R11] and [R12] are not met, then the Protection Mechanism attribute MUST be set to "other."	No	Done	N/A
<b>R14</b>	The ENNI Maximum Transmission Unit Size MUST be at least 1526 bytes.	Yes	Done	Level 1/ Foundation
<b>D1</b>	The ENNI Maximum Transmission Unit Size SHOULD be at least 2000 bytes.	Yes	Done	Level 2/ Optional Requirements
<b>R15</b>	When an ENNI Frame is larger than the MTU, the receiving Operator MEN for this frame MUST discard it, and the frame may or may not be ignored in the operation of a Bandwidth Profile that applies to this ENNI Frame.	Yes	Done	Level 1/ Foundation
<b>R16</b>	For a given S-Tagged ENNI Frame, the End Point to which it is mapped MUST be determined by the S-VLAN ID value in the S-Tag.	Yes	Done	Level 1/ Foundation
<b>R17</b>	An S-VLAN ID value MUST be used in no more than one row of the map.	Yes	Done	Level 1/ Foundation
<b>R18</b>	The End Point Type MUST be OVC End Point.	No	Done	N/A
<b>R19</b>	An ingress S-Tagged ENNI Frame that is not mapped to an existing End Point MUST NOT be forwarded to an External Interface by the receiving Operator MEN.	Yes	Done	Level 1/ Foundation
<b>R20</b>	An ENNI Frame without an S-Tag MUST NOT be mapped to an OVC End Point.	Yes	Done	Level 1/ Foundation
<b>R21</b>	Consider the OVC that associates an OVC End Point where more than one S-VLAN ID value map to the OVC End Point in the End Point Map. This OVC MUST have its S-VLAN ID Preservation attribute set to Yes. (See Section 7.2.12 of [MEF 26].)	Yes	Done	Level 2/ Bundling
<b>R22</b>	Consider the OVC that associates an OVC End Point where more than one S-VLAN ID value map to the OVC End Point in the End Point Map. This OVC MUST have its CE-VLAN ID Preservation attribute set to Yes. (See Section 7.2.10 of 0.)	Yes	Done	Level 2/ Bundling
<b>R23</b>	Consider the OVC that associates an OVC End Point where more than one S-VLAN ID value map to the OVC End Point in the End Point Map. This OVC MUST have its CE-VLAN CoS Preservation attribute set to Yes. (See Section 7.2.11 of 0.)	Yes	Done	Level 2/ Bundling
<b>R24</b>	Consider the OVC that associates an OVC End Point where more than one S-VLAN ID value map to the OVC End Point in the End Point Map. The OVC End Points associated by this OVC MUST be at an ENNI.	Yes	Done	Level 2/ Bundling
<b>R25</b>	Consider the OVC that associates an OVC End Point where more than one S-VLAN ID value map to the OVC End Point in the End Point Map. This OVC MUST associate exactly two OVC End Points.	Yes	Done	Level 2/ Bundling
<b>R26</b>	Consider the OVC that associates an OVC End Point where more than one S-VLAN ID value map to the OVC End Point in the End Point Map. Each End Point Map at the other ENNIs where there is an OVC End Point associated by this OVC MUST map the same list of S-VLAN ID values to the OVC End Point associated by the OVC.	Yes	Done	Level 2/ Bundling

Req. ID	Requirement	Applicable	Creation Status	ATS Part/ATS Group
<b>R27</b>	A given OVC MUST associate at most one OVC End Point at a given UNI.	Yes	Done	Level 1/ Foundation
<b>O1</b>	A given OVC MAY associate more than one OVC End Point at a given ENNI.	Yes	Done	Level 2/ Optional Requirements
<b>R28</b>	If an egress frame mapped to an OVC End Point results from an ingress frame mapped to an OVC End Point, there MUST be an OVC that associates the two OVC End Points. And, the two OVC End Points MUST be different from each other.	Yes	Done	Level 1/ Foundation
<b>R29</b>	At least one of the OVC End Points in an OVC MUST be at an ENNI .	Yes	Done	Level 1/ Foundation
<b>R30</b>	The OVC Identifier MUST be unique among all such identifiers for OVCs supported by the Operator MEN.	No	Done	N/A
<b>R31</b>	The OVC Identifier MUST contain no more than 45 bytes.	No	Done	N/A
<b>R32</b>	The OVC Maximum Transmission Unit Size MUST be at least 1526 bytes.	Yes	Done	Level 1/ Foundation
<b>D2</b>	The OVC Maximum Transmission Unit Size SHOULD be at least 2000 bytes.	Yes	Done	Level 2/ Optional Requirements
<b>R33</b>	When an ENNI Frame or a Service Frame is larger than the OVC MTU Size for the OVC associating the OVC End Point to which it is mapped, the receiving Operator for this frame MUST discard it, and the operation of a Bandwidth Profile that applies to this frame is not defined.	Yes	Done	Level 1/ Foundation
<b>R34</b>	The OVC Maximum Transmission Unit Size MUST be less than or equal to the MTU Size of each UNI where an OVC End Point exists that is associated by the OVC.	Yes	Done	Level 1/ Foundation
<b>R35</b>	When an OVC has the CE-VLAN ID Preservation attribute with a value of Yes and all of the UNIs with an OVC End Point associated by the OVC are such that all CE-VLAN IDs map to the OVC End Point (see Section 7.5.2 of 0), then the relationship between the format of the frame at the ingress External Interface and the corresponding frame at the egress External Interface MUST be as specified in Table 5 of 0.	Yes	Done	Level 1/ CE- VLAN ID Preservation
<b>R36</b>	When an OVC has the CE-VLAN ID Preservation attribute with a value of Yes and not all of the UNIs with an OVC End Point associated by the OVC are such that all CE-VLAN IDs map to the OVC End Point (see Section 7.5.2 of 0), then the relationships between the format of the frame at the ingress External Interface and the corresponding frame at the egress External Interface MUST be as specified in Table 6 of 0.	Yes	Done	Level 1/ CE- VLAN ID Preservation
<b>R37</b>	When an OVC has the CE-VLAN ID Preservation attribute with a value of Yes and none of the End Points associated by the OVC are at UNIs, then the relationships between the format of the frame at the ingress ENNI and the corresponding frame at the egress ENNI MUST be as specified in Table 7 of 0.	Yes	Done	Level 1/ CE- VLAN ID Preservation
<b>R38</b>	When an OVC has the CE-VLAN CoS Preservation attribute with a value of Yes the relationship between the format of the frame at the ingress External Interface and the corresponding frame at the egress External Interface MUST be as specified in Table 8 of 0.	Yes	Done	Level 1/ CE- VLAN CoS Preservation

Req. ID	Requirement	Applicable	Creation Status	ATS Part/ATS Group
<b>R39</b>	When an OVC has the S-VLAN ID Preservation attribute with a value of Yes, an egress ENNI Frame at an ENNI resulting from an ingress ENNI Frame at a different ENNI MUST have an S-VLAN ID value identical to the S-VLAN ID value of the ingress ENNI Frame.	Yes	Done	Level 2/ S-VLAN ID Preservation
<b>R40</b>	When an OVC has the S-VLAN ID Preservation attribute with a value of Yes, it MUST associate at most one OVC End Point located at a given ENNI.	Yes	Done	Level 2/ S-VLAN ID Preservation
<b>R41</b>	When an OVC has the S-VLAN ID Preservation attribute with a value of No, an egress ENNI Frame mapped to an OVC End Point resulting from an ingress ENNI Frame mapped to a different OVC End Point MUST have an S-VLAN ID value that has a one-to-one association with the S-VLAN ID of the ingress service frame.	Yes	Done	Level 1/ Foundation
<b>R42</b>	When an OVC has the S-VLAN CoS Preservation attribute with a value of Yes, an egress ENNI Frame at an ENNI resulting from an ingress ENNI Frame at a different ENNI MUST have an S-VLAN PCP value identical to the S-VLAN PCP value of the ingress ENNI Frame.	Yes	Done	Level 2/ S-VLAN CoS Preservation
<b>R43</b>	When the Color Forwarding attribute is Yes for an OVC, each egress ENNI Frame mapped to an OVC End Point that is associated by the OVC MUST be marked Yellow using one of the formats specified in Section 7.3.2 of [MEF 26] if the corresponding ingress frame into the Operator MEN satisfied one or more of the following: <ul style="list-style-type: none"> <li>The corresponding ingress frame was a Service Frame that was declared Yellow by an Ingress Bandwidth Profile and the Service Frame was mapped to an OVC End Point at the UNI that is associated by the OVC,</li> <li>The corresponding ingress frame was a Service Frame with a frame header indicating Yellow as specified in MEF 23 [MEF 23] and the Service Frame was mapped to an OVC End Point at the UNI that is associated by the OVC,</li> <li>The corresponding ingress frame was an ENNI Frame that was declared Yellow by an Ingress Bandwidth Profile and the ENNI Frame was mapped to an OVC End Point at the ENNI that is associated by the OVC,</li> <li>The corresponding ingress frame was an ENNI Frame with a frame header indicating Yellow using one of the formats specified in Section 7.3.2 of [MEF 26] and the ENNI Frame was mapped to an OVC End Point at the ENNI that is associated by the OVC.</li> </ul>	Yes	Planned	Level 1/ Color Forwarding
<b>O2</b>	When the Color Forwarding attribute is No, the Color marking of each egress ENNI Frame mapped to an OVC End Point that is associated by the OVC MAY be related to the Color of the corresponding ingress frame into the Operator Network in any way.	Yes	Planned	Level 2/ Optional Requirements

Req. ID	Requirement	Applicable	Creation Status	ATS Part/ATS Group
<b>R44</b>	When the Unicast Frame Delivery is "unconditional," all properly formatted ingress frames mapped to an OVC End Point at an External Interface with a unicast destination MAC address MUST be delivered to all of the other OVC End Points in the OVC. NOTE: The MEF26 editors clarified each R44 and R45 are conditional requirements by themselves.	Yes	Done	Level 1/ Foundation
<b>R45</b>	When the Unicast Frame Delivery is "conditional," a properly formatted ingress frame mapped to an OVC End Point at an External Interface with a unicast destination MAC address is delivered to all or a subset of all of the other OVC End Points in the OVC depending on certain conditions being met. When "conditional" is in force, the conditions for delivery MUST be specified. NOTE This requirement is not testable due to lack of specific <i>conditions</i> specified in MEF26. This is a service specification/configuration issue.	Yes	Done	Level 1/ Foundation
<b>R46</b>	When the Multicast Frame Delivery is "unconditional," all properly formatted ingress frames mapped to an OVC End Point at an External Interface with a multicast destination MAC address MUST be delivered to all of the other End Points associated by the OVC.	Yes	Done	Level 1/ Foundation
<b>R47</b>	When the Multicast Frame Delivery is "conditional," a properly formatted ingress frame mapped to an OVC End Point at an External Interface with a multicast destination MAC address is delivered to all or a subset of all of the other OVC End Points associated by the OVC depending on certain conditions being met. When "conditional" is in force, the conditions for delivery MUST be specified.	Yes	Done	Level 1/ Foundation
<b>R48</b>	When the Broadcast Frame Delivery is "unconditional," all properly formatted ingress frames mapped to an OVC End Point at an External Interface with the broadcast destination MAC address MUST be delivered to all of the other OVC End Points associated by the OVC.	Yes	Done	Level 1/ Foundation
<b>R49</b>	When the Broadcast Frame Delivery is "conditional," a properly formatted ingress frame mapped to an OVC End Point at an External Interface with the broadcast destination MAC address is delivered to all or a subset of all of the other OVC End Points associated by the OVC depending on certain conditions being met. When "conditional" is in force, the conditions for delivery MUST be specified.	Yes	Done	Level 1/ Foundation
<b>R50</b>	The OVC End Point Identifier MUST be unique among all such identifiers for OVC End Points supported by the Operator MEN.	No	Done	N/A
<b>R51</b>	The OVC End Point Identifier MUST contain no more than 45 bytes.	No	Done	N/A
<b>R52</b>	For each OVC End Point at an ENNI, each possible S-Tag PCP value MUST be included in exactly one Class of Service Identifier.	Yes	Planned	Level 1/ Class of Service Identifier
<b>O3</b>	One of the Class of Service Identifiers MAY indicate 100% discard.	Yes	Planned	Level 2/ Optional Requiremetns

Req. ID	Requirement	Applicable	Creation Status	ATS Part/ATS Group
<b>R53</b>	At a given ENNI, all OVC End Points associated by the same OVC MUST have the same Class of Service Identifiers. NOTE: This requirement is applicable for $n > 1$ OVC End Points at a given ENNI in the case of hairpin switching as covered in O1.	Yes	Planned	Level 2/ Optional Requirements
<b>D3</b>	An Operator MEN SHOULD support the use of different Class of Service Identifiers attributes for OVC End Points at an ENNI that are associated by different OVCS.	Yes	Planned	Level 2/ Optional Requirements
<b>R54</b>	Color indication for each ENNI Frame MUST conform to requirements [R3] and [R4] of MEF 23 [MEF 23].	Yes	Planned	Level 1/ Class of Service Identifier
<b>R55</b>	If the S-Tag PCP field is used to indicate Color for the ENNI Frame, then the Class of Services attribute MUST map S-Tag PCP values to L, M, and H as per [R8] of MEF 23 [MEF 23].	Yes	Planned	Level 1/ Class of Service Identifier
<b>R56</b>	If the DEI bit is used to indicate Color for the ENNI Frame, then the Class of Services attribute MUST map S-Tag PCP values to L, M, and H as per [R9] of MEF 23 [MEF 23].	Yes	Planned	Level 1/ Class of Service Identifier
<b>R57</b>	When the Ingress Bandwidth Profile per OVC End Point is in force for a given OVC End Point, suitable parameters <CIR, CBS, EIR, EBS, CF, CM> as defined in Section 7.6.1 of 0 MUST be specified and the algorithm of Section 7.6.1 of 0 MUST be applied to all ingress ENNI Frames that are mapped to the given OVC End Point.	Yes	Planned	Level 2 / ENNI Ingress OVC End Point Bandwidth Profile
<b>R58</b>	The Color Mode for the Bandwidth Profile Algorithm MUST be color-aware.	Yes	Planned	Level 2 / ENNI Ingress OVC End Point Bandwidth Profile
<b>R59</b>	When the Egress Bandwidth Profile per OVC End Point is in force for a given OVC End Point, suitable parameters <CIR, CBS, EIR, EBS, CF, CM> as defined in Section 7.6.1 of 0 MUST be specified and all egress ENNI Frames mapped to the given OVC End Point MUST have the property defined in 7.6.3 of 0.	Yes	Planned	Level 2 / ENNI Egress OVC End Point Bandwidth Profile
<b>R60</b>	The Color Mode for the Bandwidth Profile Algorithm MUST be color-aware.	Yes	Planned	Level 2 / ENNI Egress OVC End Point Bandwidth Profile
<b>R61</b>	When the Ingress Bandwidth Profile per Class of Service Identifier is in force for a given ENNI Class of Service Identifier, suitable parameters <CIR, CBS, EIR, EBS, CF, CM> as defined in Section 7.6.1 of [MEF26] MUST be specified and the algorithm of Section 7.6.1 of [MEF26] MUST be applied to all ingress ENNI Frames mapped to the OVC End Point that have the given ENNI Class of Service Identifier.	Yes	Planned	Level 1 / ENNI Ingress CoS Bandwidth Profile
<b>R62</b>	The Bandwidth Profile Algorithm MUST be color-aware.	Yes	Planned	Level 1 / ENNI Ingress CoS Bandwidth Profile

Req. ID	Requirement	Applicable	Creation Status	ATS Part/ATS Group
<b>R63</b>	When the Egress Bandwidth Profile per Class of Service Identifier is in force for a given ENNI Class of Service Identifier, suitable parameters <CIR, CBS, EIR, EBS, CF, CM> as defined in Section 7.6.1 of 0 MUST be specified and all egress ENNI Frames mapped to the OVC End Point with the given Class of Service Identifier MUST have the property defined in Section 7.6.3 of 0.	Yes	Planned	Level 1 / ENNI Egress CoS Bandwidth Profile
<b>R64</b>	The Color Mode for the Bandwidth Profile Algorithm MUST be color-aware.	Yes	Planned	Level 1 / ENNI Egress CoS Bandwidth Profile
<b>R65</b>	The UNI OVC Identifier MUST be the concatenation of the UNI Identifier and the OVC Identifier.	No	Done	N/A
<b>R66</b>	The OVC End Point at the UNI for a Service Frame MUST be identified by the value of CE-VLAN ID of the Service Frame.	Yes	Done	Level 1/ Foundation
<b>R67</b>	An ingress Service Frame that is not mapped to an existing OVC End Point or EVC at the UNI MUST be discarded.	Yes	Done	Level 1/ Foundation
<b>O4</b>	Multiple CE-VLAN IDs MAY map to a single OVC End Point.	Yes	Done	Level 2/ Optional Requirements
<b>R68</b>	Each CE-VLAN ID MUST have one of the following mutually exclusive properties; 1) it maps to one OVC End Point, 2) it maps to one EVC that associates UNIs within the Operator MEN, 3) it does not map to either such an EVC or an OVC End Point.	Yes	Done	Level 1/ Foundation
<b>R69</b>	When an OVC associating the OVC End Point to which the CE-VLAN ID for untagged and priority tagged Service Frames is mapped does not have the CE-VLAN ID Preservation attribute in force, egress Service Frames for this OVC End Point at the given UNI MUST be untagged.	Yes	Done	Level 1/ Foundation
<b>R70</b>	There MUST be three mutually exclusive ways to determine the Class of Service Identifier from the content of a given Service Frame at UNI as described in Sections 7.5.3.1, 7.5.3.2, and 7.5.3.3 of 0. This requirement is meant to explain that there ARE three mutually exclusive ways to determine the CoS ID available. It is not mentioned to mandate the support of all three for any MEF26-compliant implementation. This requirement is not testable.	Yes	Done	Level 1/ Foundation
<b>R71</b>	When the Class of Service Identifier is based on OVC End Point, all ingress Data Service Frames mapped to the same OVC End Point at the UNI MUST have the same Class of Service Identifier.	Yes	Done	Level 1/ Foundation
<b>R72</b>	The Class of Service Identifier for an ingress Data Service Frame at the UNI MUST be determined by the OVC End Point and non-overlapping sets of values of the PCP field in the C-Tag.	Yes	Done	Level 1/ Foundation
<b>R73</b>	If the ingress frame does not contain a C-Tag, it MUST have the same Class of Service Identifier as an ingress frame with Priority Code Point field = 0 in the C-Tag.	Yes	Done	Level 1/ Foundation
<b>R74</b>	The union of the sets of PCP field values MUST contain all of the possible values. NOTE: Not testable by this ATS.	No	Done	N/A

Req. ID	Requirement	Applicable	Creation Status	ATS Part/ATS Group
<b>R75</b>	The Class of Service Identifier for an ingress Data Service Frame at the UNI containing an IP packet MUST be determined by the OVC End Point and non-overlapping sets of values of the DSCP.	Yes	Done	Level 1/ Foundation
<b>R76</b>	The union of the sets of DSCP values MUST contain all of the possible DSCP values. NOTE: Not testable by this ATS.	No	Done	N/A
<b>R77</b>	Each ingress Data Service Frame at the UNI not containing an IP packet and mapped to a given OVC End Point MUST have the same Class of Service Identifier with a value agreed upon by the Operator and the Service Provider.	Yes	Done	Level 1/ Foundation
<b>R78</b>	When the Ingress Bandwidth Profile per OVC End Point at a UNI is in force for a given OVC End Point, suitable parameters <CIR, CBS, EIR, EBS, CF, CM> as defined in Section 7.11.1 of [MEF 10.2] MUST be specified and the algorithm of Section 7.11.1 of [MEF 10.2] MUST be applied to all ingress ENNI Frames that are mapped to the given OVC End Point.	Yes	Planned	Level 2 / UNI Ingress OVC End Point Bandwidth Profile
<b>R79</b>	When the Ingress Bandwidth Profile per Class of Service Identifier at a UNI is in force for a given Class of Service Identifier, suitable parameters <CIR, CBS, EIR, EBS, CF, CM> as defined in Section 7.11.1 of [MEF 10.2] MUST be specified and the algorithm of Section 7.11.1 of [MEF 10.2] MUST be applied to all ingress ENNI Frames with the given Class of Service Identifier.	Yes	Planned	Level 1 / UNI Ingress CoS Bandwidth Profile
<b>R80</b>	When the Egress Bandwidth Profile per OVC End Point at a UNI is in force for a given OVC End Point, suitable parameters <CIR, CBS, EIR, EBS, CF, CM> as defined in Section 7.11.1 of [MEF 10.2] MUST be specified and when the algorithm of Section 7.11.1 of [MEF 10.2] using these parameters is applied to these egress Service Frames, the result for each Service Frame MUST be to declare the Service Frame either Green or Yellow.	Yes	Planned	Level 2 / UNI Egress OVC End Point Bandwidth Profile
<b>R81</b>	When the Egress Bandwidth Profile per Class of Service Identifier at a UNI is in force for a given Class of Service Identifier, suitable parameters <CIR, CBS, EIR, EBS, CF, CM> as defined in Section 7.11.1 of [MEF 10.2] MUST be specified and when the algorithm of Section 7.11.1 of [MEF 10.2] using these parameters is applied to these egress Service Frames, the result for each Service Frame MUST be to declare the Service Frame either Green or Yellow.	Yes	Planned	Level 1 / UNI Egress CoS Bandwidth Profile



Req. ID	Requirement	Applicable	Creation Status	ATS Part/ATS Group
<b>R82</b>	CIR MUST be $\geq 0$ .	Yes	Planned	Level 1 / ENNI Ingress CoS Bandwidth Profile, ENNI Egress CoS Bandwidth Profile Level 2 / ENNI Ingress OVC End Point Bandwidth Profile, ENNI Egress OVC End Point Bandwidth Profile
<b>R83</b>	When CIR > 0, CBS MUST be greater than or equal to the largest Maximum Transmission Unit size allowed for the ENNI Frames that the Bandwidth Profile applies to.	Yes	Planned	Level 1 / ENNI Ingress CoS Bandwidth Profile, ENNI Egress CoS Bandwidth Profile Level 2 / ENNI Ingress OVC End Point Bandwidth Profile, ENNI Egress OVC End Point Bandwidth Profile
<b>R84</b>	EIR MUST be $\geq 0$ .	Yes	Planned	Level 1 / ENNI Ingress CoS Bandwidth Profile, ENNI Egress CoS Bandwidth Profile Level 2 / ENNI Ingress OVC End Point Bandwidth Profile, ENNI Egress OVC End Point Bandwidth Profile

Req. ID	Requirement	Applicable	Creation Status	ATS Part/ATS Group
<b>R85</b>	When $EIR > 0$ , EBS MUST be greater than or equal to the largest Maximum Transmission Unit size allowed for the ENNI Frames that the Bandwidth Profile applies to.	Yes	Planned	Level 1 / ENNI Ingress CoS Bandwidth Profile, ENNI Egress CoS Bandwidth Profile Level 2 / ENNI Ingress OVC End Point Bandwidth Profile, ENNI Egress OVC End Point Bandwidth Profile
<b>R86</b>	For a sequence of ENNI Frames, with arrival times at the reference point and lengths, the level of compliance color assigned to each ENNI Frame MUST be defined according to the algorithm in Figure 10.	Yes	Planned	Level 1 / ENNI Ingress CoS Bandwidth Profile Level 2 / ENNI Ingress OVC End Point Bandwidth Profile
<b>O5</b>	Multiple models of Ingress Bandwidth Profile application MAY exist simultaneously at an ENNI.	Yes	Planned	Level 2 / Optional Requirements
<b>R87</b>	An ENNI MUST be configured such that at most a single Ingress Bandwidth Profile applies to any given ingress ENNI Frame.	Yes	Planned	Level 1 / ENNI Ingress CoS Bandwidth Profile Level 2 / ENNI Ingress OVC End Point Bandwidth Profile
<b>R88</b>	The disposition of each ENNI Frame for delivery to each egress External Interface MUST be as described in Table 11 of 0.	Yes	Planned	Level 1 / ENNI Ingress CoS Bandwidth Profile Level 2 / ENNI Ingress OVC End Point Bandwidth Profile
<b>R89</b>	When a sequence of egress ENNI Frames with arrival times and lengths at the ENNI, are subjected to an Egress Bandwidth Profile with parameters <CIR, CBS, EIR, EBS, CF, CM>, the result of applying the algorithm of Section 7.6.1 of 0 to these frames MUST be to declare each ENNI Frame either Green or Yellow.	Yes	Planned	Level 1 / ENNI Egress CoS Bandwidth Profile Level 2 / ENNI Egress OVC End Point Bandwidth Profile

Req. ID	Requirement	Applicable	Creation Status	ATS Part/ATS Group
<b>O6</b>	Multiple models of Egress Bandwidth Profile application MAY exist simultaneously for an egress ENNI.	Yes	Planned	Level 2/ Optional Requirements
<b>R90</b>	However, an egress ENNI Frame MUST be subject to at most one Egress Bandwidth Profile.	Yes	Planned	Level 1 / ENNI Egress CoS Bandwidth Profile Level 2 / ENNI Egress OVC End Point Bandwidth Profile
<b>R91</b>	For each physical link in the ENNI, an ENNI-N MUST be capable of supporting Active DTE mode capabilities as specified in clause 57.2.9 of IEEE 802.3 [802.3 – 2005].	Yes	Planned	Level 2/ Link OAM
<b>R92</b>	For each physical link in the ENNI, an ENNI-N MUST be capable of supporting Passive DTE mode capabilities as specified in clause 57.2.9 of IEEE 802.3 [802.3 – 2005].	Yes	Planned	Level 2/ Link OAM
<b>D4</b>	When Link OAM is enabled on an ENNI-N, the loopback capability SHOULD be disabled.	Yes	Planned	Level 2/ Link OAM
<b>D5</b>	When Link OAM is enabled on an ENNI-N, it SHOULD not advertise its loopback capability, as defined in Section 57.2.11 of IEEE 802.3ah, during the discovery phase if Loopback is not enabled.	Yes	Planned	Level 2/ Link OAM
<b>D6</b>	The ENNI MTU size SHOULD be greater or equal to the MTU size of : <ul style="list-style-type: none"> <li>Each EVC MTU size crossing the ENNI plus 4 bytes (to accommodate the potential addition, at the ENNI, of an S-TAG), and</li> <li>Each OVC which has an OVC End Point at this ENNI.</li> </ul>	Yes	Done	Level 2/ Optional Requirements
<b>R93</b>	The OVC MTU size MUST be greater or equal to the EVC MTU size of each EVC supported by this OVC plus 4 bytes (to accommodate the potential addition, at the ENNI, of an S-TAG).	Yes	Done	Level 1/ Foundation

## 17.2 Metro Ethernet Network (MEN) Interior

The most important aspect of a MEN in the context of this Abstract Test Suite is its opaque interior. In our case, the MEN may either consist of a single device, be spread across multiple devices each implementing modules of the ENNI specification, or even consist of a whole network.

The ENNI ATS does not need to differentiate between these alternative uses and physical topologies: In the end the MEN remains the same from the outside point of view – a black box with ENNI and UNI interfaces subject to conformance testing independent of its interior structure.

### 17.2.1 Single Device MEN

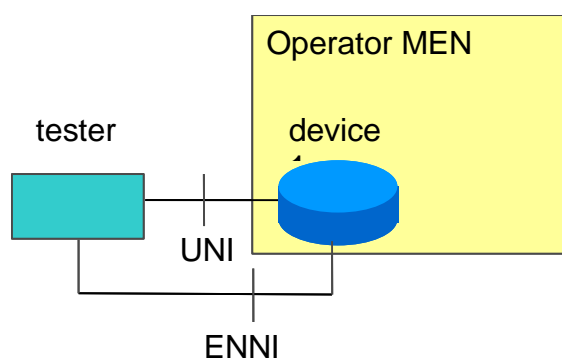
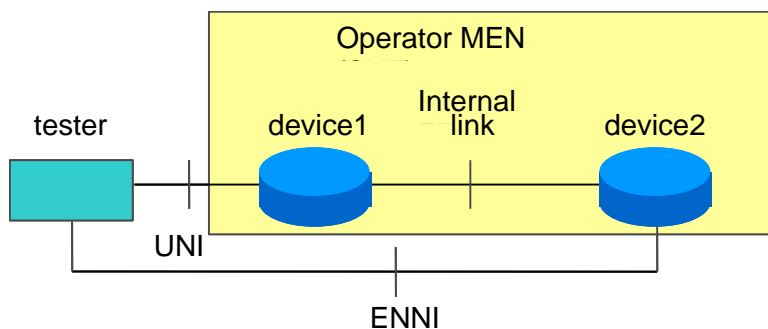

**Figure 8: Single device MEN**

In this case, all aspects of the ENNI implementation – actual ENNI port(s), UNI port(s) and a provisioning/management solution – are implemented in a single device. The conformance test solution can be directly connected with this device and the tests can be executed in an isolated way.

It is important to note that the MEN is required to implement all applicable (mandatory or conditional) ENNI requirements in order to pass all test cases of the ATS. If the *device1* would only implement a single ENNI port or would not provide a management solution to enable testing of [R3], for example, it could be tested against this ATS but would not pass all of the mandatory or conditional test cases.

### 17.2.2 Multiple Device MEN



**Figure 9: Multiple device MEN**

In this case, the ENNI implementation is spread across multiple physical devices inside the MEN. The MEN consists of the collection of all devices jointly implementing ENNI. The nature of the *link* between the devices inside the MEN is completely opaque to the test suite.

In this case, one of the devices (*device1*) only implements a UNI where the other one (*device2*) implements only an ENNI. The management is implemented on either one.

If the MEN is implemented correctly, it can pass all mandatory and conditional test cases of the ATS. Individual devices inside the MEN, if tested by their own, would fail some of the test cases or would not even qualify for any test case to be executed (otherwise the *Single Device MEN* configuration above would work as well).

### 17.2.3 Multiple Device, Separate Management

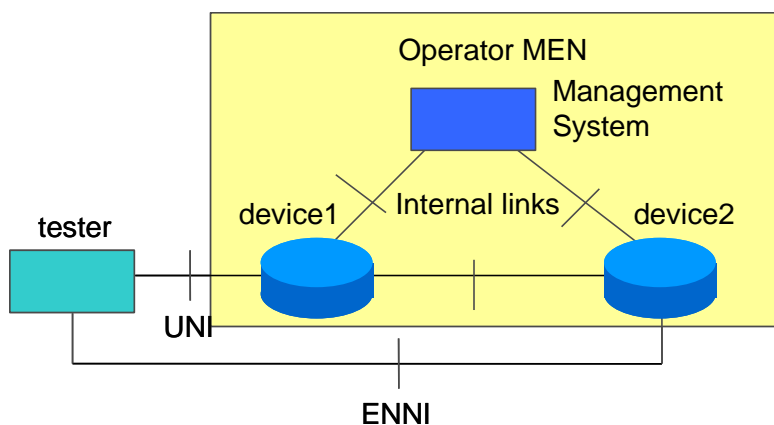

**Figure 10: Multiple devices with separate management MEN**

In this final example, major functions are spread across three types of devices. In addition to the separation of ENNIs and UNIs as above, the management (provisioning) system is contained in a separate, third device as well. Again, the interior links inside the MEN are completely opaque to the test suite.

All these are just examples of physical implementations of MENs. There can be a myriad more types of MENs – it is an explicit non-goal for the ATS to differentiate between them.

#### 17.2.4 Vendor vs. Service Provider Testing

Any of the structures above qualify for service provider testing as well as for vendor testing. Sometimes it seems to be common sense that service provider infrastructure testing must be large and complex whereas vendors would only submit a single device to a conformance test. This assumption is wrong with ENNI. As seen above, there are good reasons why vendors might sometimes want to submit an MEN with ENNI functionality consisting of multiple devices to a test. On the other hand, a service provider could pass network conformance testing with a "Single Device" MEN configuration as above, given a suitable implementation.

Whether the result of a single-device service provider test is useful is beyond the scope of this ATS and needs to be decided by the user (recipient) of the conformance test results.



### 17.3 CBS Test Procedure

This test procedure has been modeled following ITU-T Y.1564, Appendix I.2 (with stricter parameters suited to a conformance test scenario). It is applicable for a color-aware or non-color-aware service with  $CBS > 0$ . The variable names in this appendix reference variables in section 5.

1. The transmitter turns off for the minimum time necessary to fill the token bucket to or greater than  $102\% * CBS1 * 8 / CIR1$  to initialize the measurement with the  $B_c$  CBS Token Bucket full and has overflowed by an amount equal to or greater than  $2\% * CBS1$ .
2. Then the transmitter bursts the largest number of back-to-back (minimum interframe gap) frames that will draw down the number of remaining bytes in the  $B_c$  Token Bucket to more than or equal to the greatest of<sup>5</sup>:
  - a. 0.5% of CBS1
  - b. 0.5 times ENNI\_MTU
  - c. The lesser of  $(25\% * CBS1)$  and  $(0.0003 \text{ s} * CIR1 / 8)$

(After the last frame of the burst, the transmitter turns off for the smallest amount of time necessary to refill the CBS Token Bucket to at least 50% full. Then the transmitter resumes non-bursty transmission at the CIR1. Frames should be transmitted at constant intervals, e.g. without burstiness or interval variation. The period  $T$  is defined to end when the total number of frames transmitted during the period is 10 times the number of frames transmitted during the burst. The transmitter continues to cycle the frame bursting over successive periods of  $T$  in this sequence starting from step 1 until the FlowTransmissionDuration time as defined in section 5.4.8 has passed.

3. Measure the received frames upon egress at the other end of the network. All green frames shall be received.

---

<sup>5</sup> Note: These numbers represent a tolerance margin for token bucket implementations such that the token bucket is never completely emptied during the test procedure.



## 17.4 EBS Test Procedure

This test procedure has been modeled following ITU-T Y.1564, Appendix I.3 (with stricter parameters suited to a conformance test scenario). It is applicable for a color-aware service with  $CIR > 0$  and  $EBS > 0$ .

In this test there will be two test flows, the first for the Green/CBS test flow and the second for the Yellow/EBS test flow.

The green cycle has a period of nominal length  $T_G$ , and the yellow cycle has a period of nominal length  $T_Y$  both defined later. The green cycle and the yellow cycle run asynchronously with each other.

1. The green frame transmitter turns off for the minimum time necessary to fill the token bucket to or greater than  $102\% * (CBS * 8 / CIR)$  to initialize the measurement with the  $B_c$  Token Bucket full and has overflowed by at least  $2\% * CBS$ . At the same time, the yellow frame transmitter turns off for the time equal to or greater than  $102\% * (EBS * 8 / EIR)$  to initialize the measurement with the  $B_e$  Token Bucket full and has overflowed by at least  $2\% * EBS$ .
2. Then the transmitter bursts the largest number of green frames that will draw down the number of remaining bytes in the  $B_c$  Token Bucket, to more than or equal to the greatest of<sup>6</sup>:
  - a. 0.5% of the CBS1
  - b. 0.5 times ENNI\_MTU
  - c. The lesser of  $(25\% * CBS1)$  and  $(0.0003 \text{ s} * CIR1/8)$

Likewise, the transmitter bursts the largest number of yellow frames that will draw down the number of remaining bytes in the  $B_e$  Token Bucket to more than or equal to the greatest of:

- a. 0.5% of the EBS1
- b. 0.5 times ENNI\_MTU
- c. The lesser of  $(25\% * EBS1)$  and  $(0.0003 * EIR1/8)$

After the last frame of the green frame burst, the transmitter stops transmitting green frames for the smallest amount of time necessary to refill the CBS Token Bucket to at least 50% full. Likewise, after the last frame of the yellow frame burst, the transmitter stops transmitting yellow frames for the smallest amount of time necessary to refill the EBS Token Bucket to at least 50% full. Then the transmitter resumes non-bursty green and yellow frame transmission at the CIR1 and EIR1 for the rest of the periods  $T_G$  and  $T_Y$ , respectively. Each period is defined to end when the total number of frames transmitted during that period is 10 times the number of frames transmitted during the burst. At the end of each period, the cycle is repeated from the beginning of this step 1 until the FlowTransmissionDuration time as defined in section 5.4.8 has passed.

<sup>6</sup> Note: These numbers represent a tolerance margin for token bucket implementations such that the token bucket is never completely emptied during the test procedure.

3. Measure the green-colored frames, the yellow-colored frames and the total combined information rate upon egress at the other end of the network. All green frames shall be received, and more than zero yellow frames shall be received.

NOTE: The intent of this test procedure is not to test for the yellow portion of the bandwidth profile; it is only testing whether the implementation allows yellow traffic to get through at all.

**Further Notes** (not part of the test procedure):

Note that the bursting may include periods of burst green frames only, burst yellow frames only, burst green – burst yellow frames combined, and burst frames from one cycle transmitted during EIR- or CIR-spaced frames from the other cycle. When a burst frame competes for a transmission time with a spaced frame, the burst frame shall take precedence if it is the first frame in the burst. If a later frame of the burst competes with an EIR- or CIR-spaced frame for transmission, then the timing of the spaced frame shall take precedence, and the burst frame shall wait in queue.

Note that burst frames from one cycle may be transmitted freely at line rate in the spaced period of the frames from the other cycle transmitting at CIR or EIR. When burst frames of both cycles compete for the transmitter, the transmitter may be shared on a pro-rata basis between the bursts, or one burst may be served with preference while the other stream waits its turn for bursting while continuing to be served at EIR or CIR. During non-burst periods, if a green frame transmitted at CIR competes for a transmit time with a yellow frame transmitted at EIR, then the green CIR frame shall be transmitted at the proper time while the yellow frame is queued. Green CIR frames may be transmitted during the idle time between yellow frames transmitted at EIR, and yellow EIR frames may be transmitted during the idle time between green frames transmitted at CIR.