

MEF

Implementation Agreement

MEF 22.2

Mobile Backhaul Phase 3

January 2016

Disclaimer

The information in this publication is freely available for reproduction and use by any recipient and is believed to be accurate as of its publication date. Such information is subject to change without notice and the MEF Forum (MEF) is not responsible for any errors. The MEF does not assume responsibility to update or correct any information in this publication. No representation or warranty, expressed or implied, is made by the MEF concerning the completeness, accuracy, or applicability of any information contained herein and no liability of any kind shall be assumed by the MEF as a result of reliance upon such information.

The information contained herein is intended to be used without modification by the recipient or user of this document. The MEF is not responsible or liable for any modifications to this document made by any other party.

The receipt or any use of this document or its contents does not in any way create, by implication or otherwise:

- a) any express or implied license or right to or under any patent, copyright, trademark or trade secret rights held or claimed by any MEF member company which are or may be associated with the ideas, techniques, concepts or expressions contained herein; nor
- b) any warranty or representation that any MEF member companies will announce any product(s) and/or service(s) related thereto, or if such announcements are made, that such announced product(s) and/or service(s) embody any or all of the ideas, technologies, or concepts contained herein; nor
- c) any form of relationship between any MEF member companies and the recipient or user of this document.

Implementation or use of specific Metro Ethernet standards or recommendations and MEF specifications and guidelines will be voluntary, and no company shall be obliged to implement them by virtue of participation in the MEF Forum. The MEF is a non-profit international organization accelerating industry cooperation on Metro Ethernet technology. The MEF does not, expressly or otherwise, endorse or promote any specific products or services.

© MEF Forum 2016. All Rights Reserved.

Table of Contents

1.	List of Contributing Members	1
2.	Abstract	1
3.	Terminology	2
3.1	Changes to MEF 22.1	4
4.	Introduction	5
5.	Mobile Network Topologies	7
5.1	Macro Cell / Homogeneous Networks	7
5.2	Small Cell / Heterogeneous Networks.....	11
5.2.1	Radio Coordination	13
5.3	Aggregation Node.....	15
6.	Scope	17
6.1	In Scope	17
6.2	Out of Scope	18
7.	Compliance Levels	18
8.	Mobile Backhaul Service Model	19
8.1	Service Model Use Cases	20
8.1.1	Use Case 1: RAN CE with TDM Demarcation.....	20
8.1.1.1	<i>Specific Requirements related to Use Case 1:</i>	22
8.1.2	Use Case 2: RAN CE with Ethernet (MEF UNI) Demarcation	22
8.1.3	Common Requirements related to Use Cases 1 and 2.....	24
8.2	Applying MEF Service Definitions to Mobile Backhaul	24
8.2.1	Ethernet Private Line Service.....	26

8.2.2	Ethernet Virtual Private Line Service	27
8.2.3	Ethernet Private LAN Service.....	28
8.2.4	Ethernet Virtual Private LAN Service	29
8.2.5	Ethernet Private Tree Service.....	30
8.2.6	Ethernet Virtual Private Tree Service	31
8.2.7	Use Case Variations	32
8.2.8	Use Case 3: RAN CE with Macro Backhaul Extensions to Small Cells.....	33
8.3	Applying MEF Access Service Definitions to Mobile Backhaul.....	36
8.3.1	Access E-Line Service	37
8.3.2	Access E-LAN Service.....	37
9.	Management Model for Mobile Backhaul Service	37
9.1	Ethernet OAM	37
9.2	Service OAM.....	38
10.	Resiliency related Performance Attributes for EVC.....	40
10.1	Short Term Disruptions	40
10.2	Diversity	42
10.2.1	ETH-layer Diversity.....	43
10.2.2	Group Availability	44
11.	UNI Requirements	44
11.1	UNI Scalability	45
11.2	GIWF's UNI Requirements.....	46
11.3	UNI Resiliency	46
11.4	UNI PHY for Synchronization Service	47
11.4.1	UNI PHY with Synchronous mode.....	47

11.4.2	ESMC Protocol (L2CP) on UNI PHY	48
11.4.3	QL process support on UNI PHY in Synchronous mode.....	49
11.5	UNI Token Share.....	50
11.6	UNI Service Attributes	51
11.6.1	VLAN based MEF 6.2 Services.....	52
11.6.2	Port based MEF 6.2 Services	53
12.	EVC Requirements	54
12.1	Maximum Number of UNIs	55
12.2	EVC Maximum Service Frame Size	55
12.3	EVC Performance.....	56
12.3.1	Performance for Synchronization Traffic Class.....	57
12.3.2	Performance with RAN Resiliency	59
12.4	Class of Service for Mobile Backhaul.....	60
12.4.1	CoS Names.....	61
12.4.2	CoS Performance Objectives (CPO) for Backhaul	65
12.4.3	CoS Performance Objectives (CPOs) for Small Cells With Tight Radio Coordination	67
12.4.4	CoS Performance Objectives (CPOs) for Small Cells With Split Bearer	71
12.5	EVC per UNI and per EVC Service Attributes	71
12.5.1	VLAN based MEF 6.2 Services.....	72
12.5.2	Port based MEF 6.2 Services	74
13.	Synchronization.....	77
13.1	Performance of synchronization architecture	79
13.2	Packet Based Methods.....	80
13.2.1	Network (UNI-N) Interface Limits for Packet based Methods	82

13.2.2	Network (UNI-N) Interface Limits for Packet based Methods – Special Case.....	82
13.2.3	Network (UNI-N) Interface Limits for Packet based Methods, use case b.....	83
13.2.4	CES timing requirements	83
13.2.4.1	<i>Network (TDM Interface) Interface Limits at Output of GIWF.....</i>	<i>83</i>
13.2.4.2	<i>Network (TDM Interface) Interface Limits at Input of GIWF</i>	<i>83</i>
13.3	Synchronous Ethernet Methods.....	84
13.3.1	Network (UNI-N) Interface Limits for Synchronous Ethernet Methods	85
13.3.2	Network (UNI-N) Interface Limits - Special Cases	85
14.	References	87
Appendix A.	Generic Inter-working Function (Informative).....	92
A.1	Aggregation Node.....	93
Appendix B.	Mobile Backhaul User Traffic Classes (Informative)	94
Appendix C.	Mobile Backhaul Services (Informative).....	97
C.1	Use Case 1: EVP Line per RAN BS	97
C.2	Use Case 2: EVP Tree per group of RAN BSs.....	100
C.3	Use Case 3: EVP LAN per group of RAN BSs.....	102
C.4	Use Case 4: EVP Tree per Service	103
C.5	Use Case 5: Different EVC for different mobile interfaces	105
C.6	Configuration alternatives for Management plane	107
Appendix D.	Multi-CoS Backhaul with Token Sharing (Informative).....	110
Appendix E.	Radio Coordination (Informative).....	115
Appendix F.	Multi CEN Use Cases for Mobile Backhaul (Informative)	122

List of Figures

Figure 1 - Mobile Backhaul, Midhaul and Fronthaul (see 7.2.8)	6
Figure 2 - Example of topology when centralized radio control functions	8
Figure 3 - Example of topology for LTE with decentralized radio control functions	9
Figure 4: Example of topology for WiMAX with decentralized radio control functions	10
Figure 5: Increase capacity & coverage for better mobile end user experience	12
Figure 6: Radio Coordination Types.....	14
Figure 7: Distributed vs Common Baseband.....	15
Figure 8: Small Cell BS aggregation node	16
Figure 9: Generalized BS aggregation node	17
Figure 10 : Single Domain Mobile Backhaul Reference Model.....	19
Figure 11: Use Case 1a – Low Priority traffic using CES across CEN	21
Figure 12: Use Case 1b – All traffic with CES across CEN.....	22
Figure 13: Use Case 2a – Low priority traffic with MEF 6.2 Service across CEN.....	23
Figure 14: Use Case 2b – All traffic with MEF 6.2 Service across CEN.....	23
Figure 15: MEF 6.2 Service for connectivity between any RAN CEs	24
Figure 16: Ethernet Private Line (EPL) Services	27
Figure 17: Ethernet Virtual Private Line (EVPL) Services	28
Figure 18: Ethernet Private LAN (EP-LAN) Service	29
Figure 19: Ethernet Virtual Private LAN (EVP-LAN) Service.....	30
Figure 20: Ethernet Private Tree (EP-Tree) Service.....	31
Figure 21: Ethernet Virtual Private Tree (EVP-Tree) Service.....	32
Figure 22: Use case examples with CEN and non-CEN hybrid	33

Figure 23: Use Case 3: small cell extension from macro	34
Figure 24: Use case 3a: Small cell extension for LTE S1 only	35
Figure 25: Use case 3b: Small cell extension for LTE S1 and X2 (radio coordination possible) only	35
Figure 26: Use case 3c: Small cell extension for LTE X2 DC only	35
Figure 27: Example Application of OVC services to Mobile Backhaul	36
Figure 28: FM and PM Reference Model for Use Case 2	38
Figure 29: Association of EVC to two SP ECs for improved resiliency	41
Figure 30: RAN based Resiliency using diverse EVCs and optionally diverse UNIs.....	59
Figure 31: Partial diversity with common UNI at RAN BS site.....	60
Figure 32: Two CPOs for Use Case 3.....	68
Figure 33: S1u FD budget for small cell use case	71
Figure 34: Synchronization Distribution Models from PRC source to RAN BS UNI.....	80
Figure 35: UNI use cases for packet method to distribute reference timing	81
Figure 36 - ENNI use cases for packet method to distribute reference timing.....	82
Figure 37: Example of Synchronization Service using Synchronous Ethernet	84
Figure 38: Generic Inter-working Function.....	92
Figure 39: Aggregation node CE in RAN BS and/or RAN NC site.....	93
Figure 40: EVP Line per RAN BS – Use Case 1.....	98
Figure 41: EVP-Tree per group of RAN BSs – Use Case 2.....	101
Figure 42: EVP-LAN per group of RAN BSs – Use Case 3	103
Figure 43: CE-VLAN ID per service – Use Case 4.....	104
Figure 44: EVP-LAN for X2 and EVP-Line for S1 – Use Case 5	106
Figure 45: Ethernet Service for Management plane	108

Figure 46: Multiple CoS IDs on the EVC reserved for Management traffic.....	109
Figure 47: Summary of Token Sharing	112
Figure 48: Example of token sharing for Mobile Backhaul	113
Figure 49: Range expansion shown with handover (HO) bias.	117
Figure 50: enhanced Inter Cell Interference Coordination (eICIC).....	119
Figure 51: Several options of CoMP (Coordinated Multipoint).....	120
Figure 52: Example of two EVPL services used for Mobile Backhaul.....	123
Figure 53: Example of three CENs supporting EVPL with Access E-Line Services.....	123
Figure 54: Example of four CENs supporting EVPL with Access E-Line and Transit E-Line Services	124
Figure 55: Example of one EVP-LAN service used for Mobile Backhaul.....	125
Figure 56: Example of four CENs supporting EVP-LAN with Access E-Line and Transit E- LAN Services.....	125
Figure 57: Example of supporting distributed EVP-LAN Services.....	126

List of Tables

Table 1: Terminology	4
Table 2: Granularity of UNI bandwidth rates	45
Table 3: Synchronous Mode	48
Table 4: ESMC Protocol.....	48
Table 5: QL process support in Synchronous operation mode	49
Table 6: Per UNI Service Attributes for VLAN based MEF 6.2 [3] Services.....	53
Table 7: Per UNI Service Attributes for Port based MEF 6.2 [3] Services	54
Table 8: Examples of MBH Traffic Classes mapping to CoS Names in CEN.....	62
Table 9: One way CPOs across PT for Point-to-Point Mobile Backhaul service.....	67
Table 10: One way CPOs for “tight radio coordination” for Point-to-Point Mobile Backhaul case when Synchronization is not provided on the Backhaul.....	70
Table 11: EVC per UNI Service Attributes for VLAN based MEF 6.2 [3] Services.....	73
Table 12: Per EVC Service Attributes for VLAN based MEF 6.2 [3] Services.....	74
Table 13 EVC per UNI Service Attributes for Port based MEF 6.2 [3] Services	76
Table 14 Per EVC Service Attributes for Port based MEF 6.2 [3] Services	76
Table 15: Mobile Technology Synchronization Requirements	78
Table 16: WCDMA User Service Classes (3GPP 23.107 [67])	94
Table 17: WiMAX User Service Classes (IEEE Std. 802.16 [34])	95
Table 18: Standardized QCI Characteristics for LTE Service Classes 3GPP TS 23.203 [71]	96
Table 19: EVP Line per RAN BS – Use Case 1	98
Table 20: Example of CE-VLAN ID \ EVC mapping both at RAN BS UNI-N and at RAN NC UNI-N	99
Table 21: Example of multiple CoS IDs based on <EVC+PCP> – Use Case 1	100

Table 22: EVP Tree per group of RAN BSs – Use Case 2.....	101
Table 23: EVP LAN per group of RAN BSs – Use Case 3.....	103
Table 24: EVP Tree per Service – Use Case 4	104
Table 25: Example of CE-VLAN ID\EVC mapping both at RAN BS UNI-N and at RAN NC UNI-N	104
Table 26: CoS ID both per <EVC> and per <EVC+PCP> - Use Case 4	105
Table 27: EVP Tree per group of RAN BSs – Use Case 5.....	106
Table 28: Example of CE-VLAN ID \ EVC mapping both at RAN BS UNI-N and at RAN NC UNI-N	107
Table 29: Ethernet Service configuration for Management plane – An example.....	108
Table 30: Example of Multiple CoS IDs on the EVC reserved to Management.....	109
Table 31: Example of Multi-CoS Template.....	112
Table 32: Applicable phase and time synchronization, latency, and bandwidth requirements for various radio coordination features.....	116

1. List of Contributing Members

The following members of the MEF participated in the development of this document and have requested to be included in this list.

ADVA Optical Networking	Iometrix
AT&T	Microsemi
Ceregon	Nokia Networks
China Telecom	Omnitron Systems
Ciena	PLDT Corp. Business Solutions
Comcast	RAD
Ericsson	Sprint
Huawei	Verizon
Infinera	

2. Abstract

This document identifies the requirements for MEF Ethernet Services and MEF External Interfaces (EIs such as User-Network Interface (UNI)s) for use in Mobile Backhaul networks based on MEF specifications. In addition, new interface and service attributes have been specified where needed. The services and requirements in this Implementation Agreement (IA) are based on the services defined in MEF 6.2 [3], MEF 33[26] and MEF 51 [29] as well as the attributes in MEF 10.3 [7], MEF 26.1 [23] and this IA. The aim is to be flexible to support a wide range of Ethernet service based mobile network deployments.

3. Terminology

Terms defined in MEF 3[1], MEF 4[2], MEF 6.2[3], MEF 10.3[7], MEF 11[10], MEF 12.2[11], MEF 17[15], and MEF 23.1[20] are included in this document by reference and, hence, not repeated in table below.

Term	Definition	Reference
3GPP	3 rd Generation Partnership Project	3GPP TS 21.905 [67]
ABS	Almost Blank Subframes	
ACR	Adaptive Clock Recovery	ITU-T G.8260 [38] RFC 4197 [98]
aGW	Access Gateway in WiMAX or LTE networks. Also referred to as Access Service Network (ASN) Gateway in WiMAX and S-GW/MME in LTE. In this IA aGW is one of the options for a RAN NC	WMF-T32-001 [100] NGMN Alliance [102]
ASP	Application Service Provider	WMF-T32-001 [100]
Backhaul	Backhaul: The CEN between the RAN BS and the RAN NC	This IA
BBF	Broadband Forum	
BSC	Base Station Controller	3GPP TS 21.905 [67]
BTS	Base Transceiver Station	3GPP TS 21.905 [67]
CDMA	Code Division Multiple Access	TIA IS-2000.1 [62]
CoMP	Coordinated Multipoint	3GPP 36.300 [85]
CPRI	Common Public Radio Interface	CPRI [104]
CSP	Communication Service Provider	WMF-T32-001 [100]
CSG	Cell Site Gateway	BBF TR-221[89]
CSAG	Cell Site Aggregation Gateway	This IA
DL	Down Link	
DNU	Do not use	ITU-T G.781[49]
DSCP	Differentiated Services Code Point	MEF 10.3 [7] RFC 2474 [95]
EEC	Ethernet Equipment Clock	ITU-T G.8262 [41]
eICIC	Enhanced inter-cell interference coordination	3GPP TS36.133 [84]
eNB, eNodeB	Evolved Universal Terrestrial Radio Access Network (E-UTRAN) Node B is the Radio Base Station in LTE. Also referred to as eNodeB or eNB. In this IA an eNodeB is one of the options for a RAN BS	3GPP TS 36.300 [85]
ESMC	Ethernet Synchronization Message Channel	ITU-T G.8264 [43]
ESMC Frame	A Frame exchanged between a CEN and the RAN CE when UNI PHY is in synchronous operation mode	ITU-T G.8264 [43]
ESRG	ETH-layer SRG	This IA
FDD	Frequency Division Duplexing	
FeICIC	Further Enhanced inter-cell interference coordination	3GPP TS36.133 [84]

Term	Definition	Reference
Fronthaul	Fronthaul: A connection from the RAN BS site to a remote radio unit. Typically the connection is for transport of CPRI.	This IA
GIWF	Generic Inter-working Function	This IA
GSM	Global System for Mobile communication	GSM 01.04 [61]
GNSS	Global Navigation Satellite System	
GPS	Global Positioning System	
HetNet	Heterogeneous Networks	This IA
IA	Implementation Agreement	This IA
ICIC	Inter-cell interference coordination	3GPP TS36.133 [84]
IP	Internet Protocol. IPv4 is for version 4 (RFC 791) and IPv6 is for version 6 (RFC 2460)	RFC 791 [91] RFC 2460 [94]
IPsec	Internet Protocol Security	RFC 4301 [99]
LTE	Long Term Evolution	3GPP TS 36.300 [85]
LTE-A	Long Term Evolution –Advanced	3GPP TS 36.300 [85]
MASG	Mobile aggregation site gateway	BBF TR-221
MBSFN	Multimedia Broadcast Multicast Service (MBMS) over a Single Frequency	3GPP TS 25.346 [77]
Midhaul	Midhaul: The CEN between RAN BS sites. Typically one of these sites would be a macro RAN BS site.	This IA
MME	Mobility Management Entity is an LTE function and located in the Network Controller site. In this IA MME is included when referring to a RAN NC	3GPP TS 36.300 [85]
Mobile Operator	The entity obtaining the Backhaul service from a SP or CEN Operator. Also referred to as Subscriber in this IA	This IA
N/S	Not specified	This IA
NB, NodeB	WCDMA Radio Base Station. In this IA a NodeB is one of the options for a RAN BS	3GPP TS 21.905 [67]
NSP	Network Service Provider	WMF-T32-001 [100]
NTP	Network Time Protocol	RFC 1305 [92]
OFDM	Orthogonal frequency-division multiplexing	
PCEF	Policy and Charging Enforcement Function	3GPP TS 23.203[71]
PCP	Priority Code Point	IEEE E Std. 802.1Q™ [31]
PDH	Plesiochronous Digital Hierarchy	ITU-T G.705 [60]
PEC	Packet based Equipment Clocks	ITU-T G.8261 [39]
PRC	Primary Reference Clock	ITU-T G.811 [52]
PTP	Precision Time Protocol	IEEE Std. 1588™-2008 [35]
QL	Quality Level of clock used in Synchronous Ethernet	ITU-T G.8264 [43]
RAN	Radio Access Network	3GPP TS 36.300 [85]
RAN BS	RAN Base Station	This IA
RAN CE	RAN Customer Edge	This IA
RAN NC	RAN Network Controller	This IA
RBS	Radio Base Station defined in this IA and referred generally as Base Station in 3GPP TS 21.905	This IA
RNC	Radio Network Controller	3GPP TS 21.905 [67]
RTP	Real-time Transport Protocol	RFC 3550 [97]

Term	Definition	Reference
S-GW	Serving Gateway is an LTE function and located at the Network Controller site. In this IA S-GW is one of the options for RAN NC	3GPP TS 36.300 [85]
Small Cell	Small Cell: operator-controlled, low-powered radio access nodes, which typically have a range from 10 metres to several hundred metres	SCF [89]
SP	Service Provider. The organization providing Mobile Backhaul Service to a Mobile Operator.	This IA
SRG	Shared Risk Group. Set of NEs that are collectively impacted by a specific fault or fault type	RFC 3386 [96]
SSM	Synchronization Status Message	ITU-T G.8264 [43]
TDD	Time Division Duplexing	
TLV	Type Length Value fields in ESMC Frame	ITU-T G.8262 [41]
UE	User Equipment	
UL	Up Link	
VLAN	Virtual LAN	MEF 10.3 [7] IEEE Std. 802.1Q [31]
WCDMA	Wideband Code Division Multiple Access	3GPP TS 21.905[67]
WiMAX	Worldwide Interoperability for Microwave Access	WMF-T32-001 [100]
WLAN	Wireless Local Area Network (aka IEEE Std. 802.11)	

Table 1: Terminology

3.1 Changes to MEF 22.1

This revision makes the following changes to MEF 22.1:

1. Incorporation of MEF 22.1.1 Small Cells amendment, which includes:
 - a. Backhaul, Midhaul and Fronthaul are defined in section 3
 - b. Small Cells, along with heterogeneous networks and radio coordination, are introduced in section 4
 - c. Use case variations are added in section 7.2.7
 - d. A new use case 3 is defined in section 7.2.8 for the midhaul case
 - e. CoS Performance Objectives (CPOs) for small cells with tight radio coordination are described in section 12.4.3
 - f. CPOs for small cells with split bearer are described in section 12.4.4
 - g. A new Appendix A.1 defines the Aggregation Node
 - h. A new Appendix E summarizes Long Term Evolution (LTE) radio coordination
 - i. Error correction in Figure 30 of Appendix C.6
2. Alignment with MEF 6.2 and MEF 10.3, which results in:
 - a. reduced requirements
 - b. addition or deletion of some User-Network Interface (UNI) and Ethernet Virtual Connection (EVC) attributes
 - c. change in recommendation for Link Operations, Administration, and Maintenance (OAM) and Service OAM (SOAM)
 - d. simplification of attribute tables in sections 10 and 11
 - e. addition of token sharing guidance in Appendix D

3. Addition of multi-Carrier Ethernet Network (multi-CEN), which includes:
 - a. Introduction of Ethernet Access (E-Access) services in 8.3
 - b. Guidance on Operator Virtual Connection (OVC) use cases for Mobile Backhaul (MBH) in Appendix F

4. Introduction

The term Mobile Backhaul includes a collection of networks and network technologies, including the transport between parts of the Radio Access Network (RAN) and Core Networks. Mobile Backhaul networks were originally realized using TDM and ATM technologies. Ethernet services are now almost universally available, even at sites with access to legacy services. This opportunity allows Mobile Operators to make the choice of which transport technology to utilize. In some cases where there is circuit based equipment that is co-located with newer Ethernet based equipment it might be suitable to use a single transport technology providing Ethernet services to lower costs. Hence, next generation mobile equipment and networks with Ethernet service layer (ETH) functions (MEF 12.2 [11]) can support MEF Carrier Ethernet Services (MEF 6.2 [3], MEF 33[26] and MEF 51 [29]) using Service Attributes defined in MEF 10.3 [7], MEF 23.1 [20], MEF 26.1 [23], and this IA. Carrier Ethernet services will provide the connectivity in the Mobile Backhaul network, possibly in a converged network together with traditional fixed services for business and residential services. MEF Carrier Ethernet services can be supported over any Transport (TRAN) layer (MEF 4 [2]).

This Implementation Agreement uses the term Mobile Backhaul to refer to the network between the Base Station sites and the Network Controller/Gateway sites for all generation of Mobile Technologies. Additionally, this IA introduces a variant of Mobile Backhaul termed Midhaul that refers to the network between base station sites (especially when one site is a small cell site). It is useful to also use the term Fronthaul to refer to the intra-base station transport -- that is between the baseband unit and radio unit. These terms are shown in Figure 1 - . The Next Generation Mobile Network (NGMN) Alliance [102] defines Backhaul Solution for Long Term Evolution (LTE) and Worldwide Interoperability for Microwave Access (WiMAX) as including the transport module in the base station (e.g. enhanced NodeB (eNB) in LTE or Base Station in WiMAX) to the transport module in the controller Access Gateway. When the transport modules in the Evolved Node B (eNB) or Access Gateway (aGW) also support MEF's User-Network Interface-Customer (UNI-C) functions then the NGMN Alliance's definition of Backhaul is equivalent in scope to MEF's UNI-C to UNI-C Subscriber EC (MEF 12.2 [11]) and this IA's Mobile Backhaul. In some cases MEF UNI-C might be supported on co-located platforms owned by the Mobile Operator instead of on the eNB or aGW. This case is in scope for this IA thus making this IA's Mobile Backhaul scope different from the NGMN Alliance's definition of Backhaul. In Broadband Forum TR-221 [89], Mobile Backhaul, these platforms are identified as a cell site gateway (CSG) and a Mobile Aggregation Site Gateway (MASG) and have scope limited to the case where they are MPLS PEs and exclude Circuit Emulation Service (CES) over Ethernet. Broadband Forum (BBF) TR-221[89] does not explicitly provide the case for Mobile Operator owned CSG or MASG providing aggregation and UNI-C, but it is not excluded.

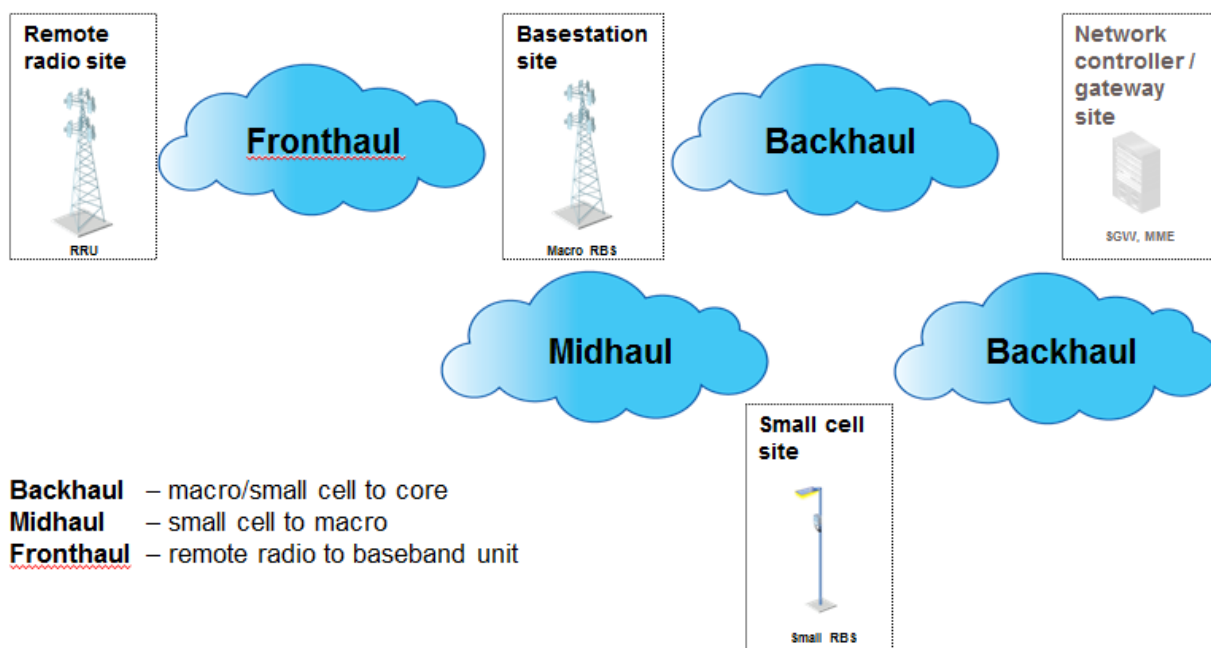

Figure 1 - Mobile Backhaul, Midhaul and Fronthaul (see 7.2.8)

This IA defines the role of a Mobile Operator (Subscriber or Customer) as one purchasing a MEF service for Mobile Backhaul from a Carrier Ethernet Network (CEN) Operator (Service Provider or Operator). These roles can also be applied for business units within the same Operator where a wireless business unit might obtain the MEF service from the transport (e.g. metro or access) business unit. The Mobile Operator is not constrained by this IA in using MEF Services with EIs only at the Base Station or Network Controller/Gateway sites. Such scenarios could involve multiple CENs, i.e., multiple network sections, to support the Mobile Backhaul between the Base Station sites and Network Controller/Gateway sites. A Mobile Operator might need MEF Services only for a portion of the Mobile Backhaul, i.e., not all the way to the RAN Network Controller (NC) site, since they own the rest of the backhaul.

A Mobile Operator can also choose to use MEF services from a CEN Operator for some network sections of the Mobile Backhaul and use non MEF services for other network sections of the Mobile Backhaul network. This IA applies to the sections with MEF Services. If certain network sections of a Mobile Backhaul network use any non MEF Services then those sections are out of scope for this IA. When combinations of MEF and non-MEF services are used the Mobile Operator is responsible to concatenate performance across the different sections.

This document specifies the requirements for Ethernet services, EIs and Management for Mobile Backhaul. These definitions aim to support a wide range of Ethernet service based mobile network topologies.

5. Mobile Network Topologies

This section illustrates different radio network topologies, how they relate to certain mobile technologies, and what to consider when defining Ethernet services for different topologies. It is not the ambition to provide a full description of each mobile technology. The reader is advised to consult the appropriate mobile standard for additional details.

5.1 Macro Cell / Homogeneous Networks

Mobile technologies, such as Global System for Mobile communications (GSM), Wideband Code Division Multiple Access (WCDMA) and Code division multiple access (CDMA), use centralized radio control functions. This means that user plane and control plane traffic is sent directly between Radio Base Stations (RBS) and the Network Controller (NC). Figure 2 below provides an example of centralized connectivity for GSM, where the Radio Base Station is called Base Transceiver Station (BTS) and the Network Controller is called Base Station Controller (BSC), and WCDMA where the Radio Base Station is called the NodeB and the Network Controller is called Radio Network Controller (RNC). The figure includes the logical interfaces¹ defined by 3rd Generation Partnership Project (3GPP) connecting the Radio Base Station and Network Controller. CDMA networks are constructed in a similar fashion.

¹ The logical interfaces between radio nodes represent relationships between those nodes; they do not represent physical connections. This implies that a logical interface can traverse several intermediary nodes.

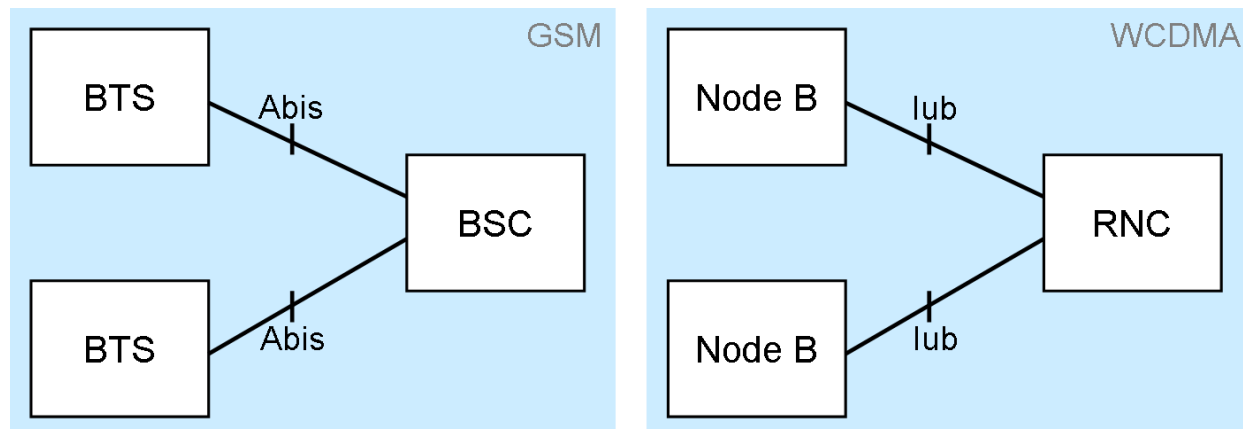

Figure 2 - Example of topology when centralized radio control functions

The evolution of mobile technologies has led to a decentralized topology as a result of some functionality previously residing in the network controller being pushed out to the radio base station. This is the case for both LTE and WiMAX. LTE is exemplified in the Figure 3 below showing logical interfaces in the wireless network topology. Notably, 3GPP Release 8 (LTE) is based on IP bearer channels like 3GPP Releases 5 to 7, but has a definitive multipoint topology as each eNB is connected to multiple functions in the Evolved Packet Core (EPC) – the direct interfaces being with other eNBs, Serving Gateway (S-GW) and Mobility Management Entity (MME). These functions need not be located at the same physical site. Having the core functions geographically distributed to support S1-flex architectures, i.e. MME pool areas (3GPP TS23.401[73]), might require deployment of certain Ethernet services (MEF 6.2 [3]) to realize the connectivity between the RAN CEs. See also Section 8.2 for additional discussion.

The S-GW terminates the user plane traffic and the MME terminates the signaling or control plane traffic with the S1 logical Interface. There can be up to 16 S1 interfaces per eNB site as identified by the NGMN Alliance [102]. It should be noted that LTE has the concept of “pooling”, where a pool consists of one or more entities, which means that an eNB can be connected to a pool of S-GWs and MMEs (3GPP TS36.300 [85]).

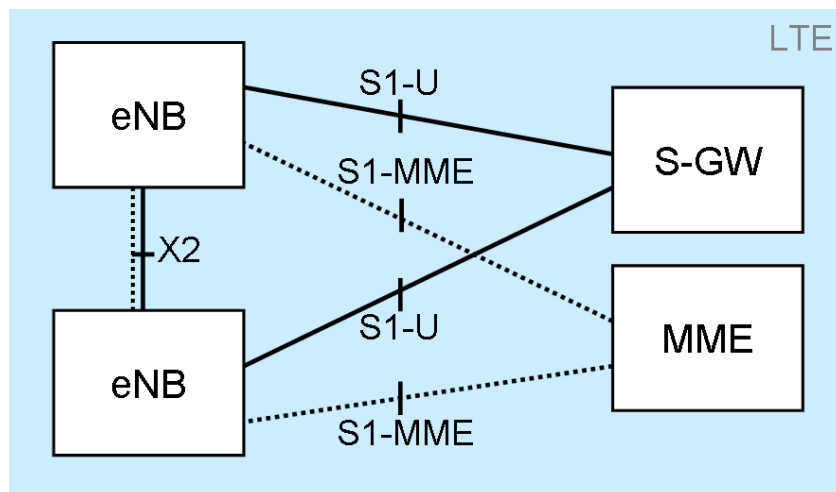

Figure 3 - Example of topology for LTE with decentralized radio control functions

Another notable difference in LTE is the logical interface between eNBs, called X2, which is not present in GSM or WCDMA. In LTE, this interface is used only for direct handovers between eNB nodes and this handover is initially independent of S-GW and MME. The original and destination eNBs, involved in the handover of the user equipment, coordinate together data traffic forwarding over the X2 interface from the original eNB to the destination eNB. The destination eNB, now with the user equipment associated to it, informs the S-GW/MME about shifting traffic from the original eNB (that is being sent over X2 interface during the handover) to the S1 interface for the destination eNB. Each eNB has an X2 interface relationship with a set of neighboring eNBs whereby radio handovers are possible. There can be up to 32 neighbors for each eNB [102]. Note that the RAN Basestation (BS) and/or NC sites can now be Internet Protocol (IP) endpoints and the Network Elements at these sites can support additional functionality such as IP routing. Such capability can also be used by the Mobile Operator to constrain how the X2 connectivity across the CEN is supported. Additionally, the set of radio neighbors for a given eNB are unique and dynamic, meaning an eNB might have a different set of radio neighbors over time.

Figure 4 shows the section of WiMAX network reference model from IEEE Std. 802.16™ [34] and WMF-T32-001-R016v01 [100] relevant for this IA. The Mobile Backhaul, as defined by WiMAX forum, is from RAN BS to Access Service Network Gateway node (ASN GW). The Access Service Network (ASN) provides access to the WiMAX air interface and is controlled by the Network Access Provider (NAP). The ASN is connected to multiple core functions in the Connectivity Service Network (CSN) which provides connectivity to Internet or an Application Service Provider (ASP). The CSN is controlled by a Network Service Provider (NSP).

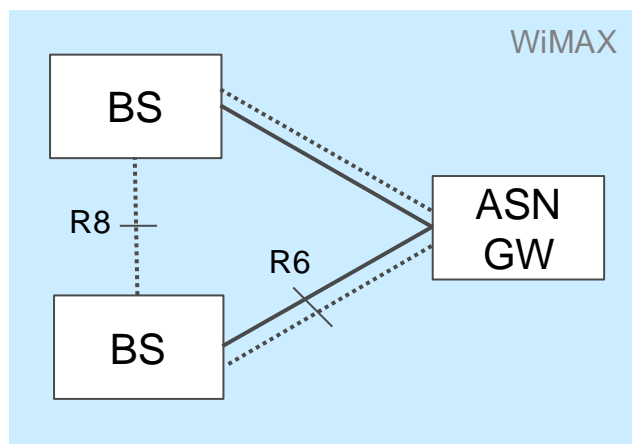

Figure 4: Example of topology for WiMAX with decentralized radio control functions

The ASN is comprised of one or more ASN-GW(s), a large number of BSs, and standard routing/switching equipment interconnecting them. The BS provides air interface coverage over one sector. The ASN-GW is a centralized controller for all the BSs in the ASN. The ASN-GW acts as a datapath anchor for the ASN and provides mobility control for all the BSs in the ASN. Interface R8 is the standard reference point between BSs in the same ASN. It is only a control channel which can be used to exchange information between BSs. The R6 standard reference point is the backhaul between the BS and the ASN-GW.

LTE and WiMAX are radio technologies based on IP bearer channels to support user IP traffic. GSM and WCDMA systems evolved from ATM and, optionally to, IP bearer from 3GPP Release 5 to support user IP traffic. Note that 3GPP TS 25.933 [82] (in Section 5.8) does not make any assumption for IP based packet transport network. With MEF compliant UNI-C (MEF 11 [10] and MEF 20 [17]) Ethernet interfaces Mobile Network components in the RAN BS or RAN NC sites can use MEF Services for IP packet transport across a CEN. Mobile Network components with TDM interfaces can use MEF 3 [1] Circuit Emulation Services via a Generic Inter-working Function (GIWF) for connectivity across a CEN and can also add MEF compliant UNI-C Ethernet interfaces to offload IP data traffic. See Section 8.1 for further discussion.

Some radio deployments will utilize security mechanisms, such as IP Security (IPsec) (RFC4301 [99]) which is optional in 3GPP and WiMAX specifications, when the Mobile Backhaul connectivity to RAN BS is through untrusted domains. In a centralized topology the security gateway will typically be located on the same site as the network controller. The Mobile Backhaul connectivity across CEN might be mostly Point-to-Point type between a RAN BS and RAN NC site when IPsec is used for mobile technologies with a centralized Security Gateway architecture.

Operations & Maintenance (O&M) traffic for Base Station management can be treated as a separate logical interface. This implies that O&M traffic can have a different logical and physical connectivity compared to control plane and user plane traffic.

5.2 Small Cell / Heterogeneous Networks

The Small Cell Forum defines a ‘small cell’ as an umbrella term for operator-controlled, low-powered radio access nodes, which typically have a range from 10 metres to several hundred metres [103]. This contrasts with a typical mobile macrocell that might have a range of up to several tens of kilometres. For the purposes of this IA, we introduce a classification of small cells based on the type of backhaul architecture. The following types of small cells are envisioned:

1. Femto: Backhaul is for the femto interfaces, and via an untrusted backhaul to a centralized Security Gateway and Femto gateway. The mobile RAN loses visibility of the user device when the device connects to a femto (e.g., there is no X2 interface between the macro and femto).
2. Pico/Micro: This is an eNB or NodeB (NB) that functionally is exactly the same as a macro eNB/NB only smaller in size and power. It uses Iub, S1, X2 interfaces on the backhaul and is visible to the macro layer.

MEF services, and this IA, are focused on “pico/micro” small cells. While not prohibited, MEF services used for “femto” small cells are outside the scope of this IA. Note that the base stations described previously in Figure 2 (BTS, nodeB), Figure 3 (eNB) and Figure 4 (BS) may be “pico/micro” small cells.

‘Heterogeneous’ refers to the different types of base stations (e.g., macro, micro, pico) that are used together in the same wireless network to build the coverage and capacity that end-users demand from their operator. This is in contrast to ‘homogeneous’ networks that are built with one type of base station, often the macro. As a result, a Heterogeneous Network (HetNet) provides a seamless broadband user experience for mobile customers independent from their location. Note that the small cells (e.g., micro, pico) can include additional radio access technologies, such as WLAN, which share the small cell backhaul.

As can be seen with the lower (purple dotted) line in Figure 5, the available capacity for a subscriber depends on their location. There are three improvements (identified in then Figure 5) that HetNet could address for operators:

1. To increase the capacity on existing cells and for the network as a whole.
2. To improve performance in the cell edges.
3. To provide coverage or to improve performance indoors.

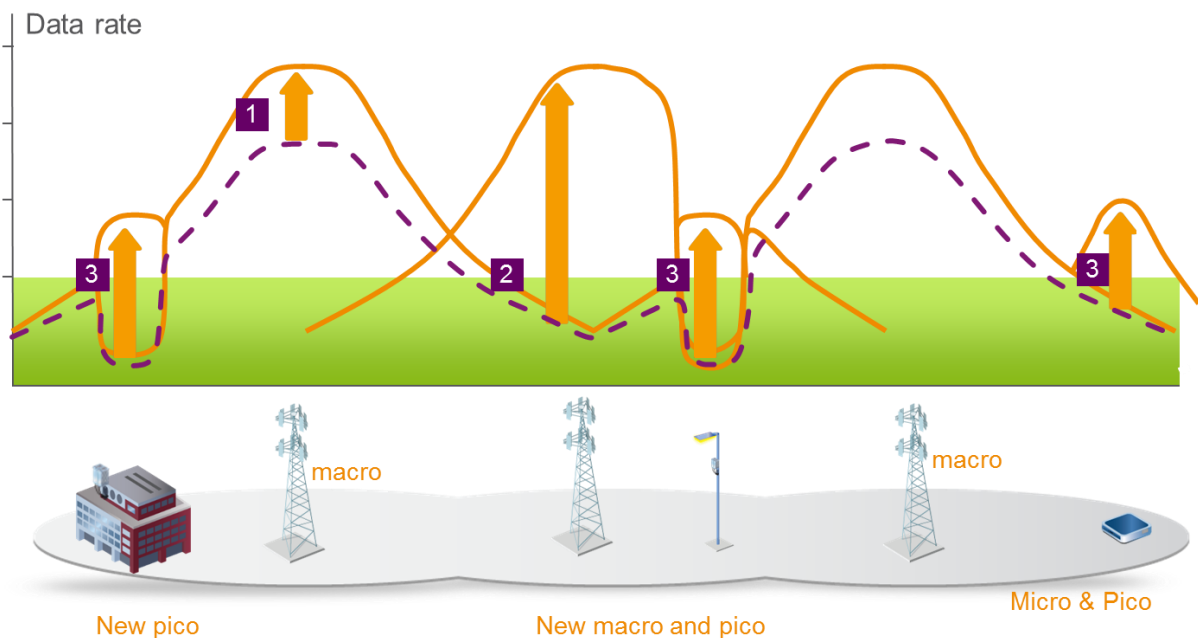

Figure 5: Increase capacity & coverage for better mobile end user experience

Solution 1 (indicated by 1 in Figure 5) Macro Optimization:

Usually, the most effective first step in improving overall performance in a mobile network is to optimize existing macro sites by updating technology, aligning antennas, adding frequencies and sectors, etc.

Solution 2 (indicated by 2 in Figure 5) Cell Split:

Should Solution 1 not be sufficient, the common next step is to add additional macro sites that are similar to existing macro sites. A cell split typically dramatically increases capacity in the cell edge and results in more consistent network coverage with better performance.

Solution 3 (indicated by 3 in Figure 5) Small Cells Additions:

Additionally, the operator can choose to deploy small cells to solve coverage holes or to increase capacity in some regions. In fact, these coverage and capacity issues might exist even if the operator implemented Solutions 1 and 2. There can be several micro and pico small cells required within a macro cell coverage area with each offloading a small percentage of the macro traffic. Other areas that can benefit from the addition of these “small cells” will again be cell edges where speed and throughput benefit from a well placed small cell. Example use cases support indoor areas such as homes or businesses to provide better coverage and/or increase capacity.

All of these HetNet solutions will demand more bandwidth or higher performance from the backhaul.

5.2.1 Radio Coordination

Radio coordination, effectively radio resource control signalling between base stations, is a concept that is very important with respect to HetNet. To clarify, consider the extremes. If one is using separate frequencies for small cells and the macro cell, there is no need for coordinating the radio resources. Similarly, coordination is not needed when an indoor cell is shielded from the external macro cells using the same frequencies and radio resources.

The other extreme is when the same frequencies are used and interference impedes performance. In this case, some form of tight radio coordination is required to optimize performance. In this scenario, the macro cell and the small cells are communicating with each other and coordinating simultaneous use of resources. For example, a terminal can use the downlink from a macro cell and the uplink from a small cell with resource utilization coordinated between the cells. This helps to mitigate the performance issues associated with interference, but it places very stringent requirements on delay, synchronization and in some cases, bandwidth.

The need for coordination varies significantly. The “very tight coordination” case is the most extreme in terms of requirements and performance. The backhaul/midhaul can support different degrees of coordination to enhance the performance and total bandwidth in an area by supporting the radio technology (e.g., certain LTE or LTE-A) features and associated requirements on the backhaul transport characteristics. MEF Ethernet service solutions with relatively stringent performance, including low latency and sufficient bandwidth, meet these “tight coordination” requirements in some cases. The delivery of accurate time alignment between neighbor cells allows the use of more demanding radio coordination features. A common accurate time reference can be provided by different means, such as the installation of GNSS/GPS receivers at the base stations, or the delivery of an accurate synchronization reference by the mobile backhaul network using a time protocol such as IEEE 1588 [35] (e.g., packet-based method with full timing support to the protocol level from the network G.8260 [38], as defined in the PTP profile G.8275.1 [47], also known as PTP with “on path” support). Additional information about the phase and time synchronization requirements associated with coordination of these radio technologies are described in Appendix E.

Defining radio network function coordination levels is useful for understanding use cases and the associated requirements. This grouping will allow a common treatment for backhaul/midhaul performance. The three defined levels of radio coordination are shown in Figure 6: no coordination, moderate coordination and tight coordination. They all assume that there are at least two cells (e.g., macro and small cell) that require coordination with each other. While most commonly involving a small cell, radio coordination is not limited to small cells only. The impact of small cells on backhaul/midhaul requirements depends significantly on the level of coordination. Below is a taxonomy for three levels of coordination that are in-scope for this IA.

- **No coordination**- uncoordinated deployment with femtos or picos/micros (usually for coverage use cases) in a macro network. Note that femtos are out of scope for this IA.
- **Moderate coordination** - deployment of small cells using radio coordination with the macros.

- E.g. range expansion, adaptive resource partitioning, Inter-cell Interference Coordination (ICIC) and enhanced ICIC (eICIC). (Appendix E)
- **Tight coordination** - coordinated scheduling (on air interface) of uplink and/or downlink
 - E.g., Coordinated Multipoint (CoMP) feature including uplink (UL)/downlink (DL) scheduling and link adaptation (Appendix E)
 - In addition to the CoMP functional requirements, for LTE Frequency Division Duplexing (FDD) this implies additional synchronization requirements including phase and time synch, associated with more stringent backhaul/midhaul performance requirements. Phase and time synchronization will be addressed in a future deliverable of MBH IA Phase 3.



Figure 6: Radio Coordination Types

The following level of coordination is out of scope for this IA:

- **Very tight coordination**- coordinated deployment with remote radio units (usually for capacity use cases in dense urban congested environments) from a common baseband unit. This is in contrast to a distributed baseband architecture that supports moderate/tight radio coordination for small cells as shown in Figure 7.
 - E.g., CoMP feature including UL/DL beamforming and joint transmission/reception (see Appendix E)
 - The main/remote interface is a specialized radio over fiber interface, e.g., the internal Common Public Radio Interface (CPRI) interface [104]. Supporting CPRI requires several “gigabits per second” of bandwidth and other highly stringent performance characteristics like extremely low latency, jitter, and packet loss. CPRI is often carried directly over fiber, over microwave or with wavelength division multiplexing (WDM).
 - MEF Ethernet Services cannot currently support the fronthaul of CPRI

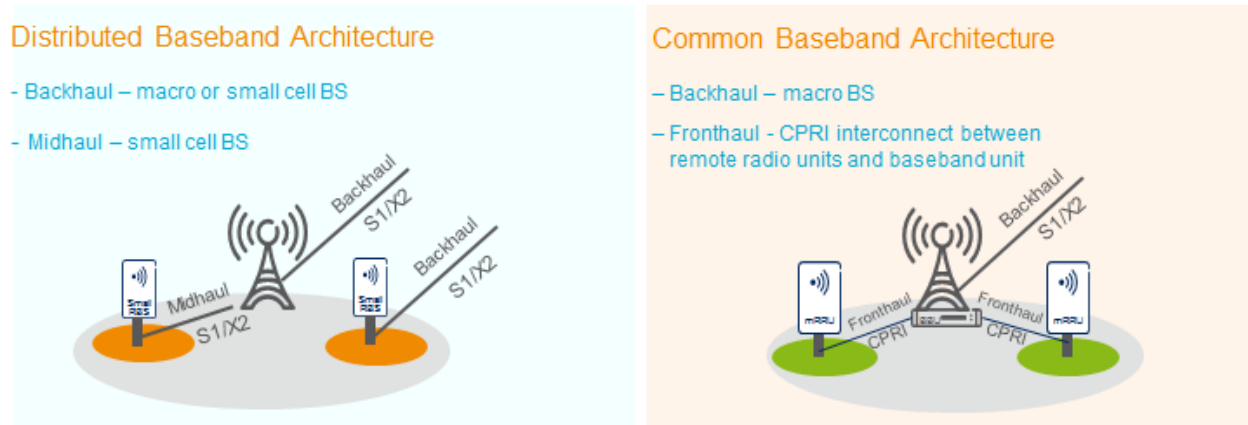

Figure 7: Distributed vs Common Baseband

Additional detail on several LTE and LTE-A features, their latency and synchronization requirements, and their allocation into this taxonomy is described in Appendix E.

Capacity driven use cases are most likely to leverage tight coordination, and coverage cases are least likely since they tend to be more isolated from the macro cell. In addition, when small cells are deployed in dense clusters they are more likely to benefit from tight coordination.

In many cases, radio characteristics can be adapted to backhaul transport. However, in general better performing backhaul transport allows better performance of the small cell and therefore higher overall mobile system performance.

5.3 Aggregation Node

Aggregation nodes can be utilized at the RAN BS site or the RAN NC site to aggregate traffic onto common backhaul whether or not small cells are involved. For example, a BS aggregation node can be used for aggregating various nearby BS sites via Mobile Operator transport, such as microwave, at a hub BS site or to aggregate different radio access technologies at a BS site. These BSs can be a macro or small cell. In various industry documents this BS aggregation node might also be referred to as a Cell Site Aggregation Gateway (CSAG) or cell site router.

There are particular benefits for aggregation nodes for small cells. Without aggregation nodes, the deployment of many small cells per macro cell would significantly increase the number of UNIs and/or EVCs required in the backhaul network. For many deployments, a small cell BS aggregation node, such as a cell site aggregation router, would be beneficial to aggregate the BSs onto a single MBH interface for backhaul. A typical use for such an aggregation node would be in a building with a number of small cell BSs as shown in Figure 8. While this aggregation node is not an eNB/NB, it can be considered a RAN BS in the context of this IA, requiring a single backhaul. This is similar to the case in macro cell site backhaul whereby a BS aggregation node is used to aggregate multiple macro base stations and/or multiple radio technologies onto a single backhaul UNI.

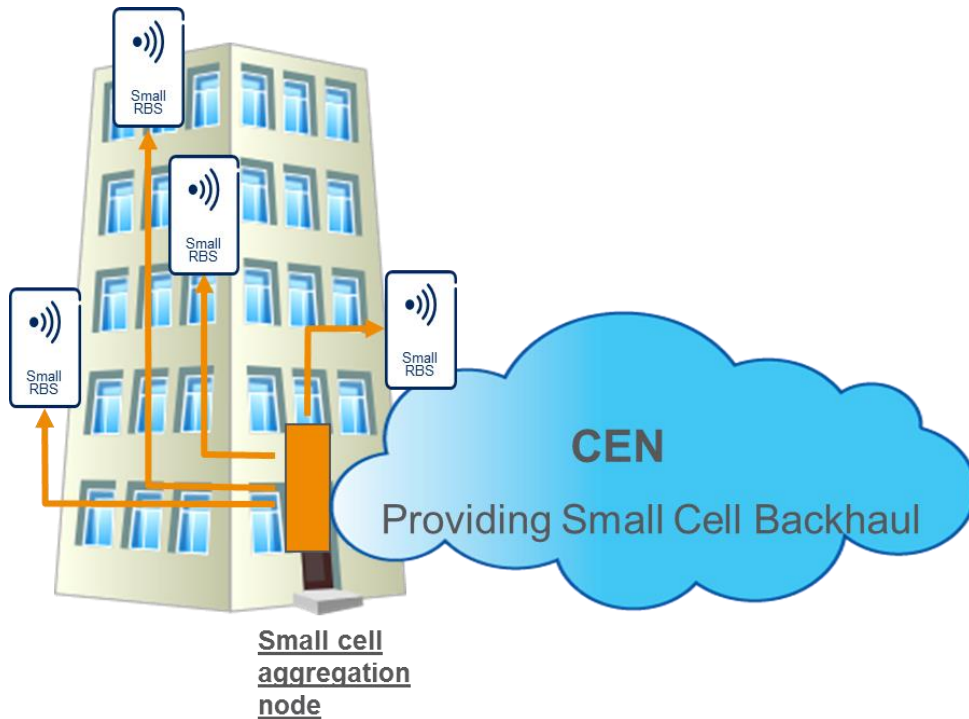

Figure 8: Small Cell BS aggregation node

BS aggregation nodes are a type of RAN CE (see section 8). They are normally owned by the Mobile Operator and thus considered CE from a MEF perspective. BS aggregation nodes will not be normatively specified in this IA (See appendix A.1). BS aggregation nodes can implement generic MEF functionality that is attributed to CE and UNI-C functions in various MEF specifications. A generic view is shown in Figure 9 that encompasses a multi-operator aggregation, multi-standard radio aggregation and small cell aggregation. There are many variations that are possible for deployment. The common element in all deployments is the CSAG function.

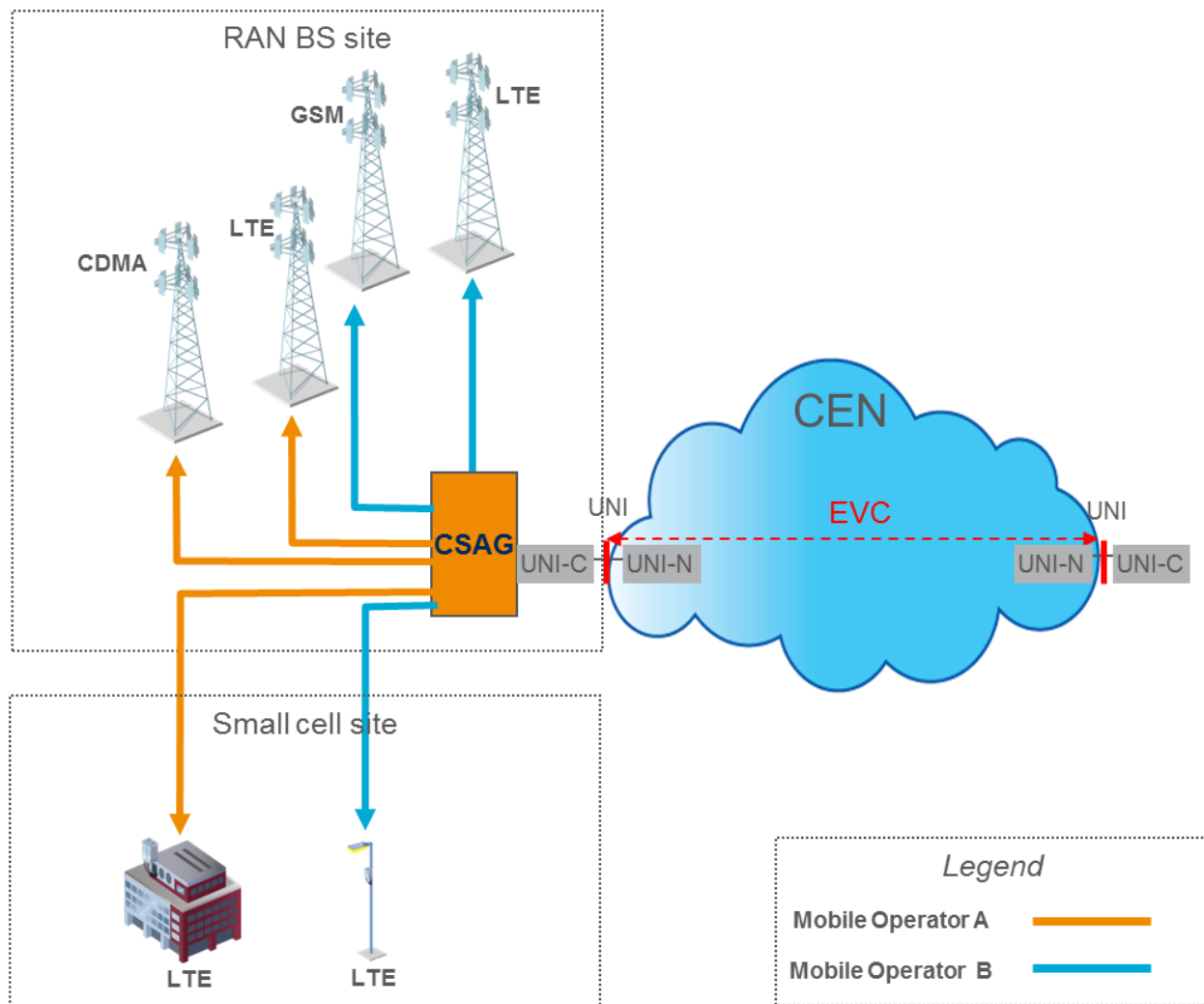

Figure 9: Generalized BS aggregation node

6. Scope

6.1 In Scope

The following work items are within the scope of this phase of Implementation Agreement:

- Mobile backhaul and midhaul, for macro and small cells, for mobile technologies referenced in standards: GSM, WCDMA, CDMA2000, WiMAX 802.16e, LTE, and LTE-A.
- Support a single CEN with External Interfaces being only UNIs for Mobile Backhaul between RAN BSs and RAN NC.
- Utilize existing MEF technical specifications with required extensions to interface and service attributes.
- Provide requirements for UNI-C and UNI-N beyond those in MEF 13 [12] and MEF 20 [17].

- Provide requirements for ENNI beyond those in MEF 51 [29].
- Define requirements for Mobile Backhaul with Ethernet Services specified in MEF 6.2 [3], MEF 33 [26], and MEF 51 [29].
- Provide requirements for Link OAM, Service OAM Fault Management.
- Provide requirements for Class of Service and recommend performance objectives consistent with MEF 23.1 [20], where possible.
- Specify frequency synchronization requirements where possible for packet based synchronization methods and Synchronous Ethernet.
- Define functional requirements applicable to Generic Inter-Working Function interfaces.
- Specify resiliency related performance requirements for Mobile Backhaul.
- Include Multiple CENs based on OVC Service Definitions

6.2 Out of Scope

Topics that are not within the scope of this phase of Implementation Agreement include:

- Provide an architectural and functional description of the CEN internals.
- Provide a normative definition or implementation specification of the Generic Inter-working Function.
- Provide details regarding other technologies for Backhaul Networks (e.g. Legacy ATM or TDM or IP transport).
- Specify time and phase synchronization methods and requirements.
- Specify multiple clock & time domain synchronization methods and requirements.
- Define synchronization architectures or promote any particular synchronization technology.
- Define mobile network evolution scenarios.
- Provide fronthaul between a baseband unit and a radio unit (e.g., “very tight coordination” case using CPRI)
- Specify backhaul for femto interfaces

7. Compliance Levels

The key words "**MUST**", "**MUST NOT**", "**REQUIRED**", "**SHALL**", "**SHALL NOT**", "**SHOULD**", "**SHOULD NOT**", "**RECOMMENDED**", "**MAY**", and "**OPTIONAL**" in this document are to be interpreted as described in IETF RFC 2119 [92]. All key words must be in upper case, bold text.

Items that are **REQUIRED** (contain the words **MUST** or **MUST NOT**) will be labeled as **[Rx]** for required. Items that are **RECOMMENDED** (contain the words **SHOULD** or **SHOULD NOT**) will be labeled as **[Dx]** for desirable. Items that are **OPTIONAL** (contain the words **MAY** or **OPTIONAL**) will be labeled as **[Ox]** for optional.

A paragraph preceded by **[CRa]**<, where *a* indicates a sequentially increasing number throughout the document, specifies a mandatory requirement that **MUST** be followed if the condition(s)

following the “<” have been met. For example, “[CR1]<[D38]” indicates that conditional requirement 1 must be followed if desired requirement 38 has been met. A paragraph preceded by [C**D***b*]<, where *b* indicates a sequentially increasing number throughout the document, specifies a desired requirement that **SHOULD** be followed if the condition(s) following the “<” have been met. A paragraph preceded by [C**O***c*]<, where *c* indicates a sequentially increasing number throughout the document, specifies an optional requirement that **MAY** be followed if the condition(s) following the “<” have been met.

8. Mobile Backhaul Service Model

This section includes: a description of a Mobile Backhaul reference model; definitions of reference points and functional elements; and describes use cases that reflect possible Mobile Backhaul deployments.

A Mobile Backhaul network can take on many forms depending on factors such as transport technology, mobile standard, operator preference, etc. This Implementation Agreement (IA) focuses on the Mobile Backhaul network between Radio Base Station sites and Radio Network Controller/Gateway sites. The Mobile Backhaul service is between demarcations separating the responsibility of a Service Provider (SP) or CEN Operator’s domain and the Mobile Operator’s domain. This is the CEN supporting MEF 6.2 Services [3] between UNI reference points. Figure 10 describes a service reference model where the Mobile Backhaul service across a single domain (i.e., single Service Provider) is providing connectivity to Mobile Network Nodes, i.e., RAN CEs. The use of multiple CEN operators for Mobile Backhaul supporting MEF 51 OVC Services [29] leverages ENNI reference points (not shown).

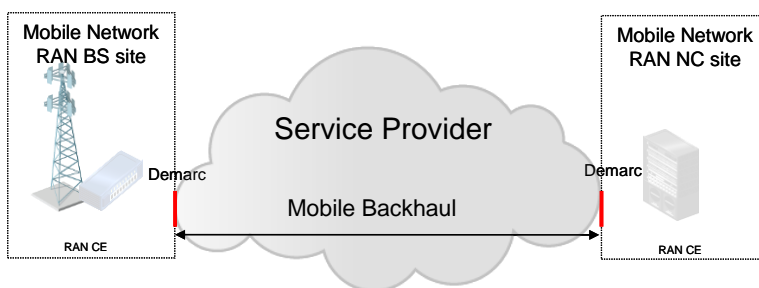

Figure 10 : Single Domain Mobile Backhaul Reference Model

RAN CE is a generic term that identifies a mobile network node or site, such as a RAN Network Controller (RAN NC) or a RAN Base Station (RAN BS). A RAN NC might be a single network controller/gateway or a site composed of several network controllers including: OSS, WCDMA Radio Network Controller, or synchronization server. A RAN BS site can also be a single base station or a collection of several base stations of the same or different technologies. For example, a RAN BS site can contain a GSM and WCDMA radio base station.

A RAN CE might have legacy TDM interfaces. Hence, a Mobile Operator can use a TDM demarcation to obtain CES (MEF 3 [1] and MEF 8 [4]) for emulation of TDM Services across the Service Provider's CEN. Alternatively, with an Ethernet interface supporting MEF ETH layer functions (MEF 12.2 [11]) the Mobile Operator can obtain Ethernet Services (e.g., MEF 6.2 [3]) from the SP. The EVC or OVC is the service construct offered by the CEN in support of a MEF service. The technical definition of a service, is in terms of what is seen by each CE (MEF 10.3 [7]). This includes the UNI which is the demarcation point between the responsibility of the CEN Operator and the responsibility of the Mobile Operator.

8.1 Service Model Use Cases

Based on the basic reference model above in Figure 10 it is possible to derive the use cases below, where each use case presents a possible deployment scenario using MEF services. Two Use Cases are described in this subclause, with variations for small cells in section 8.2.7 and a third in section 8.2.8. Although the use cases are not exhaustive of all possible deployment scenarios, they will be the foundation of this IA. The focus of this IA is to recommend capabilities at the EI and applicable MEF Services in support of Mobile Backhaul; referencing MEF specifications, and specifying extensions when necessary. While the use cases describe an evolution of the basic service model shown in Figure 10 it is possible for the legacy and CEN domains to be different SPs.

8.1.1 Use Case 1: RAN CE with TDM Demarcation

Use cases 1a and 1b are example deployments where the RAN BS and RAN NC cannot be directly connected to a MEF Ethernet UNI (MEF 11 [10]) because they have non-Ethernet based service interfaces, such as ATM or TDM. The TDM demarcation at the RAN BS and NC sites is the scope for Mobile Backhaul as illustrated in Figure 11 and Figure 12. Use cases 1a and 1b require a GIWF, which in turn is connected to the UNI for a MEF 6.2 Service [3] across the CEN domain. The GIWF is described in Appendix A: Generic Inter-working Function (Informative).

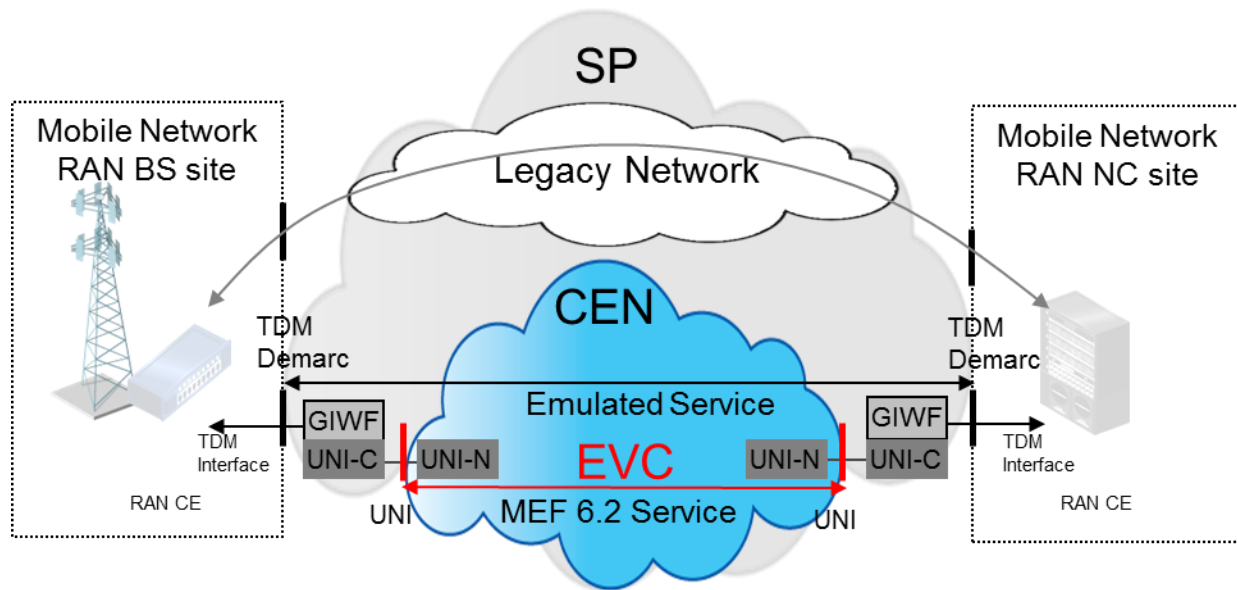

Figure 11: Use Case 1a – Low Priority traffic using CES across CEN

Use case 1a, shown in Figure 11, illustrates a split service scenario where there are two parallel Mobile Backhaul services, across a legacy (e.g. TDM) network and across a CEN, that transport different types of mobile traffic. As shown in Figure 4, SP owns the GIWF function and, for example, a CES across the CEN domain, using the framework defined in MEF 3 [1], is offered to the Mobile Operator. This might be appropriate in cases where a Mobile Operator wants to offload low priority but high bandwidth traffic from the legacy network to the CEN in order to scale with network demand. How and where traffic is split and sent over the legacy network is out of scope for this IA.

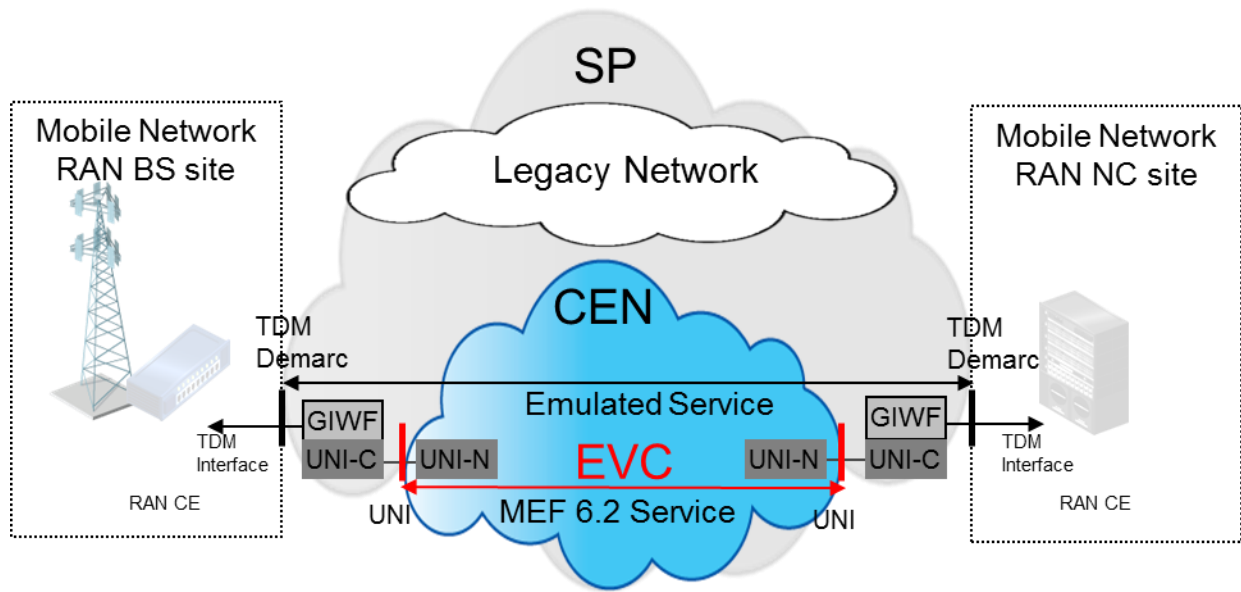

Figure 12: Use Case 1b – All traffic with CES across CEN

Use case 1b, shown in Figure 12, depicts a deployment scenario where the RAN CE with TDM interface is connected to the SP at a TDM demarcation but all traffic from the RAN CE now uses CES across the CEN with Ethernet services.

8.1.1.1 **Specific** Requirements related to Use Case 1:

- Synchronization with TDM demarcation: See Interface requirements in Section 13.2.3
- CoS & CPO: See Class of Service in Section 12.4

8.1.2 **Use Case 2: RAN CE with Ethernet (MEF UNI) Demarcation**

Use cases 2a and 2b illustrate RAN CE equipment that can be connected directly to the CEN with a MEF compliant UNI-C Ethernet interface eliminating the need for a GIWF. Similar to use case 1a, use case 2a, as shown in Figure 13, uses MEF 6.2 services [3] to offload certain traffic, such as low priority high bandwidth traffic, from the legacy network. How the RAN CE transports real-time and synchronization traffic via the legacy network is out of scope for this implementation agreement.

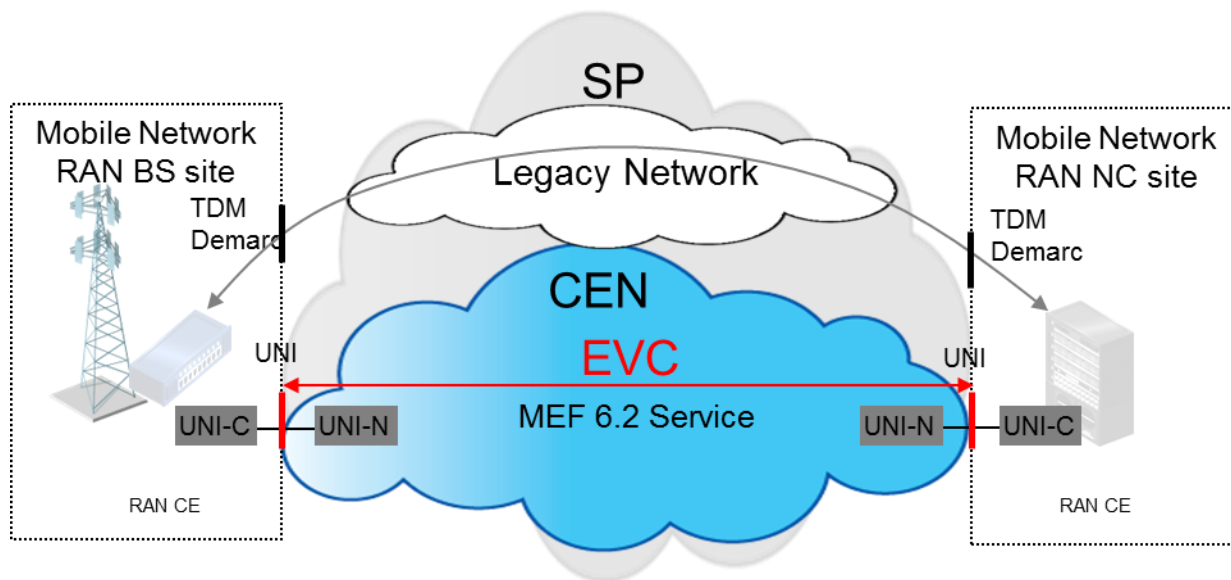

Figure 13: Use Case 2a – Low priority traffic with MEF 6.2 Service across CEN

It should be considered that in use case 1a and 2a, frequency synchronization is typically recovered from the legacy network, e.g.; from TDM physical layer. This implies that for use case 1a and 2a synchronization with Physical Layer (Synchronous Ethernet) or Packet based methods are not required to be provided by CEN.

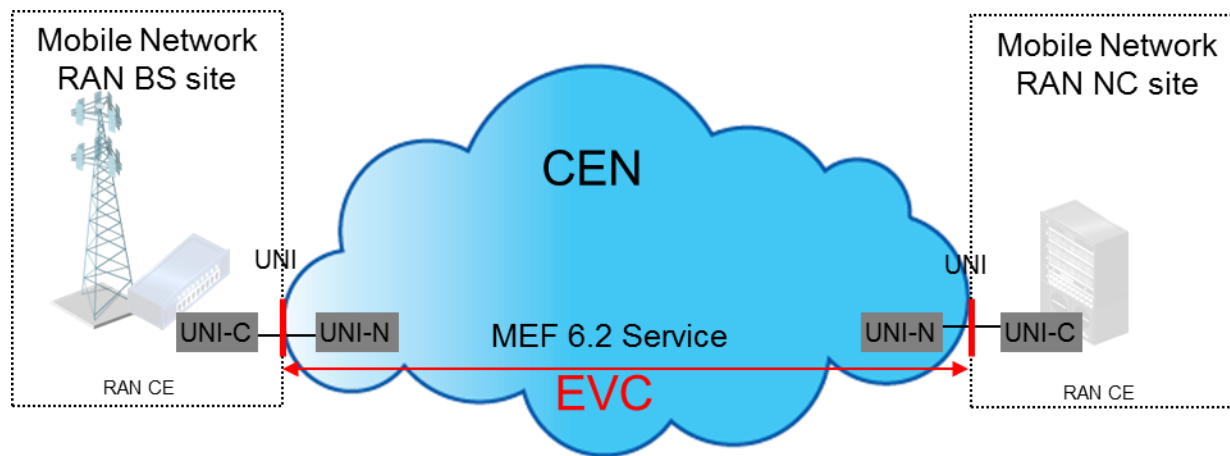

Figure 14: Use Case 2b – All traffic with MEF 6.2 Service across CEN

Lastly, use case 2b, shown in Figure 14, is the case where all traffic uses MEF 6.2 Ethernet services [3] across the CEN. How the Ethernet services are realized can vary depending on the mobile technology that is deployed, vendor equipment, operator requirements, and the type of services offered by the CEN.

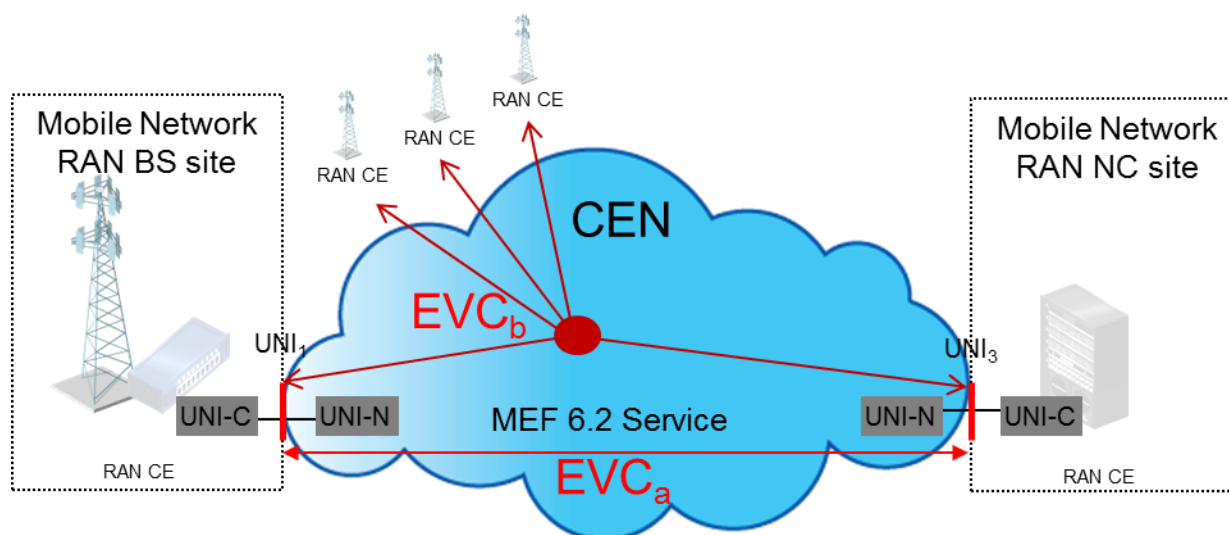

Figure 15: MEF 6.2 Service for connectivity between any RAN CEs

In Figure 15, Mobile Backhaul is shown with different EVC types (MEF 10.3 [7]). Either Point-to-Point (e.g. EVC_a) or Multipoint (EVC_b) can be used to support the logical interfaces for user and signaling plane between RAN CEs. Use of different EVC types is discussed in Section 8.2 (Normative) and in Appendix C - Mobile Backhaul Services (Informative).

The RAN CE base station shown in Figure 13, Figure 14, and Figure 15 represent both small cells and macro cells. That is, for this use case either could be present.

8.1.3 Common Requirements related to Use Cases 1 and 2

- MEF 6.2 Services: See Section 8.2
- OAM for Fault Management (FM) and Performance Monitoring (PM): See Section 9 and 11.1
- UNI: See Section 11
- Performance attributes and objectives: See Sections 10, and 12
- EVC: See Section 12
- Synchronization: See Sections 11.4 and 13

8.2 Applying MEF Service Definitions to Mobile Backhaul

This section specifies the Mobile Backhaul Ethernet services. In addition to the baseline definition of MEF Services in MEF 6.2 [3], using service attributes defined in MEF 10.3 [7] and MEF 23.1 [20], this IA has specified requirements using attributes defined in this IA. Appendix B in MEF 6.2 [3] provides information on being backwards compatible for a MEF 6.1 Service to the Subscriber (Mobile Operator in this IA).

- [R1] The CEN (or SP) **MUST** meet the mandatory requirements of MEF 6.2 that apply to a given Mobile Backhaul Ethernet service
- [R2] The Mobile Backhaul Ethernet Service Provider between MEF compliant UNIs **MUST** offer a service that complies with one of the following Virtual LAN (VLAN) based Ethernet service definitions (MEF 6.2 [3]) in terms of the service attributes for UNI and EVC, in addition to those specified in this IA (see also Section 11.6.1 and Section 12.5.1):
1. Ethernet Virtual Private Line Service (EVPL)
 2. Ethernet Virtual Private LAN service (EVP-LAN)
- [D1] The Mobile Backhaul Ethernet Service Provider between MEF compliant UNIs **SHOULD** offer a service that complies with the following VLAN based Ethernet service definition (MEF 6.2 [3]) in terms of the service attributes for UNI and EVC, in addition to those specified in this IA (see also Section 11.6.1 and Section 12.5.1):
1. Ethernet Virtual Private Tree Service (EVP-Tree)

A Mobile Operator is more likely to use VLAN based services (EVPL, EVP-LAN, and EVP-Tree) given the scalability of supporting many RAN BS sites with each UNI interface at a RAN NC site. Further, such VLAN based services also allow bandwidth profiles to be tailored to the needs of a RAN BS. For example, a smaller subset of RAN BSs might have higher user density with more traffic while most other RAN BSs might not. A Port based service such as EP-LAN, for example, is constrained to applying one Ingress bandwidth profile per Class of Service Identifier at the UNI in the RAN NC site for traffic to all RAN BSs UNIs in the EVC. A Port based service also dedicates a RAN NC UNI resulting in inefficient use of the port. However, port based services could be applicable when a Mobile Operator uses each UNI port at RAN NC to be associated with UNIs at a limited number of RAN BSs so a failure of the UNI at RAN NC or in the CEN does not impact all RAN BSs.

- [D2] The Mobile Backhaul Ethernet Service Provider between MEF compliant UNIs **SHOULD** offer a service that complies with the following Port based Ethernet service definition (MEF 6.2 [3]) in terms of the service attributes for UNI and EVC in addition to those specified in this IA (see also Section 11.6.2 and Section 12.5.2):
1. Ethernet Private LAN Service (EP-LAN)
- [O1] The Mobile Backhaul Ethernet Service Provider between MEF compliant UNIs **MAY** offer a service that complies with one of the following Port based Ethernet service definitions (MEF 6.2 [3]) in terms of the service attributes for UNI and EVC in addition to those specified in this IA (see also Section 11.6.2 and Section 12.5.2):
1. Ethernet Private Line Service (EPL)
 2. Ethernet Private Tree Service (EP-Tree)

See Section 11.5 for the UNI Service Attributes and Section 12.5 for EVC Service Attributes from MEF 6.2 [3] as well as constraints, if any, as defined in this IA.

In LTE and WiMAX, E-Line is more likely to be used when IPsec mechanisms are used to transit through untrusted CEN domains with centralized Security Gateways. E-Line can be used to support both S1 (or WiMAX R6) and X2 (or WiMAX R8) traffic. For X2 or R8 interface, E-Tree with root UNI at RAN NC site is also a possibility. In these cases it is assumed that a switching or routing function exists at the RAN NC of the Mobile Operator domain to forward X2 or R8 traffic to destination RAN BS sites.

Alternatively, an E-LAN service can be used to support traffic between RAN BSs as well as to RAN NC. Such a multipoint service can provide the necessary connectivity between RAN CEs in the same IP subnet.

The RAN NC itself can be viewed as an aggregation facility in that it can support service connectivity to large numbers of RAN BS sites. The NGMN Alliance [102] suggests example dimensioning and scalability with 1000 eNB sites per aGW. So, a RAN NC site might support up to 16000 S1 Interfaces with 16 S1 interfaces per eNB. Often the RAN NC is in a single location that gives mobile providers several options to connect RAN BSs with the RAN NC, including: a port-based implementation with one UNI per RAN BS, or a VLAN-based implementation with EVCs from different RAN BSs service multiplexed at one or more RAN NC UNIs. When several EVCs are multiplexed on a single UNI, there is a risk of a single point of failure, and therefore an appropriate EVC resiliency performance should be considered. A similar approach might also be adopted at other UNIs in the Mobile Backhaul network, for example at RAN BS sites with several base stations. Refer to Section 10 for resiliency performance attributes, Section 11.3 for UNI Resiliency, and Section 12.3.1 and 12.3.2 for Resiliency performance.

A Mobile Backhaul Service with a bundle of 1 or more MEF 6.2 [3] Services is not specified by the IA.

8.2.1 Ethernet Private Line Service

The Ethernet Private Line (EPL) service (MEF 6.2 [3]) is a port based service with exactly 2 UNIs in an EVC. It is equivalent to the leased line service used for Mobile Backhaul service between the RAN NC and RAN BS. All untagged, priority tagged and tagged Service Frames are mapped to 1 EVC at the UNI. The EPL service might be preferred in cases where there is a desire for a 1:1 port level correspondence between the RAN NC and each RAN BS UNI as shown in Figure 16. Port based EPL services with dedicated UNI ports at RAN NC for every BS is not a scalable model. VLAN based EVPL as described in Section 8.2.2 is preferred.

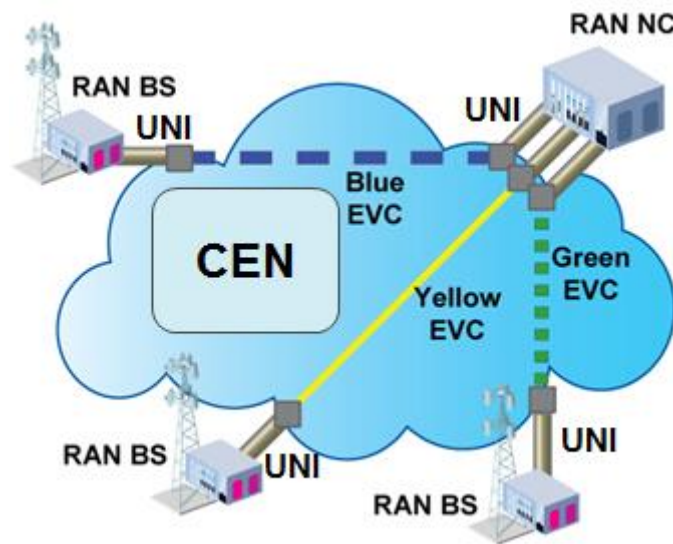

Figure 16: Ethernet Private Line (EPL) Services

8.2.2 Ethernet Virtual Private Line Service

The Ethernet Virtual Private Line (EVPL) service (MEF 6.2 [3]) for Mobile Backhaul is a VLAN based service with exactly 2 UNIs in an EVC and is used to access multiple RAN sites with Service Multiplexing (>1 EVC) at the RAN NC UNI. This allows efficient use of the RAN NC UNI, as illustrated in Figure 17. The CE-VLAN ID to EVC map and Bundling service attributes (MEF 10.3 [7]) are used to identify the set of CE-VLANs, including untagged and priority tagged Service Frames, which map to specific EVCs at the UNI. At the RAN NC UNI, for example, if there is an EVC per RAN BS site then there is an upper bound of 4094^2 RAN BSs, assuming 1 CE-VLAN ID per RAN BS site.

² As mentioned in MEF 10.3 [7] section 9.9, note that the Customer VLAN Tag values 0 and 4095 in IEEE Std 802.1Q [31] are reserved for special purposes

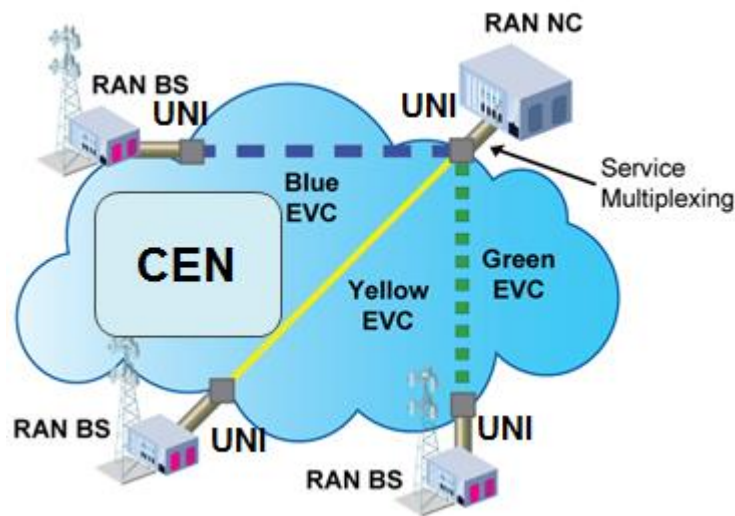

Figure 17: Ethernet Virtual Private Line (EVPL) Services

8.2.3 Ethernet Private LAN Service

Mobile Operators, with multiple RAN NC sites or deployments where inter RAN BS communication is permitted, might want to interconnect them so all sites appear to be on the same Local Area Network (LAN). The Ethernet Private LAN (EP-LAN) service (MEF 6.2 [3]) as shown in Figure 18, provides a port based service with 2 or more UNIs in the EVC.

The EP-LAN service is defined to provide All to One bundling at each UNI, CE-VLAN ID preservation, CE-VLAN CoS preservation, and forwarding of key Layer 2 Control Protocols per MEF 45 [28]. A key advantage of this approach is that if the Mobile Operator has outsourced its backhaul network to a service provider, e.g., transport/transmission network organization, the Mobile Operator can configure CE-VLANs at the RAN NCs and the RAN BSs without any need to coordinate with the Service Provider.

In LTE or WiMAX deployments, the EP-LAN service can be used to connect RAN BS sites containing eNBs or WiMAX BSs on the same IP subnet to realize the X2 or R8 interface respectively. Furthermore, EP-LAN services provide efficient connectivity between eNBs and pooled gateway nodes, such as S-GW and MME that might reside on different RAN NC sites.

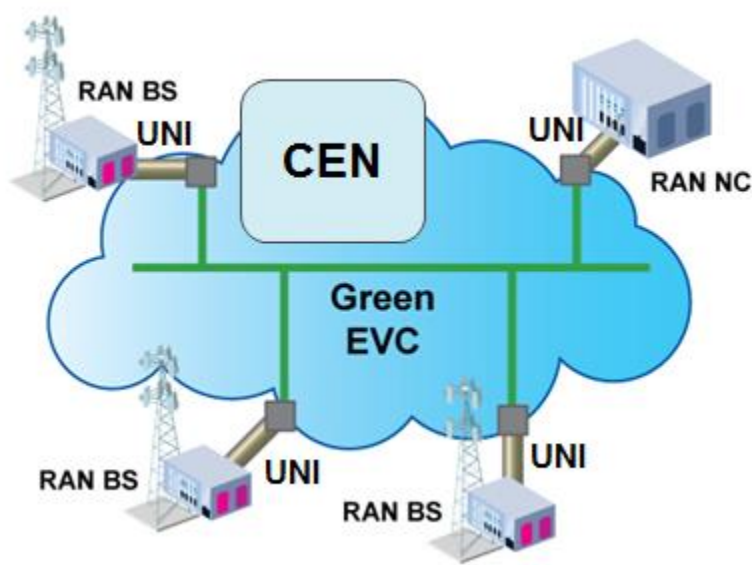

Figure 18: Ethernet Private LAN (EP-LAN) Service

8.2.4 Ethernet Virtual Private LAN Service

Some Mobile Operators commonly desire an E-LAN service type (MEF 6.2 [3]) to connect their UNIs in a CEN, while at the same time accessing other services from one or more of those UNIs. An example of such a UNI is a Mobile Operator site that has co-location of RAN BS of different technologies, e.g. legacy GSM and WiMAX. Each technology can have a specific EVC assigned to transport Mobile Backhaul traffic and different UNI peers. The Ethernet Virtual Private LAN (EVP-LAN) service is as shown in Figure 19 (as the red EVC). The other EVCs at a Service Multiplexed UNI can be Point-Point (blue EVC is shown) or Multipoint-to-Multipoint or Rooted-Multipoint EVC type.

The EVP-LAN service allows less transparency with respect to CE-VLAN ID and L2CP processing than the EP-LAN service. As example, different CE-VLAN ID sets can be mapped to the different EVCs at the UNI with Service Multiplexing. The CE-VLAN to EVC map and Bundling service attributes (MEF 10.3 [7]) are used at the UNIs. Operators can also configure required L2CP processing as specified in Multi-CEN L2CP Processing, MEF 45 [28]. As such, CE-VLAN ID preservation, CE-VLAN CoS preservation, and forwarding of certain Layer 2 Control Protocols can be constrained as defined in MEF 45 [28].

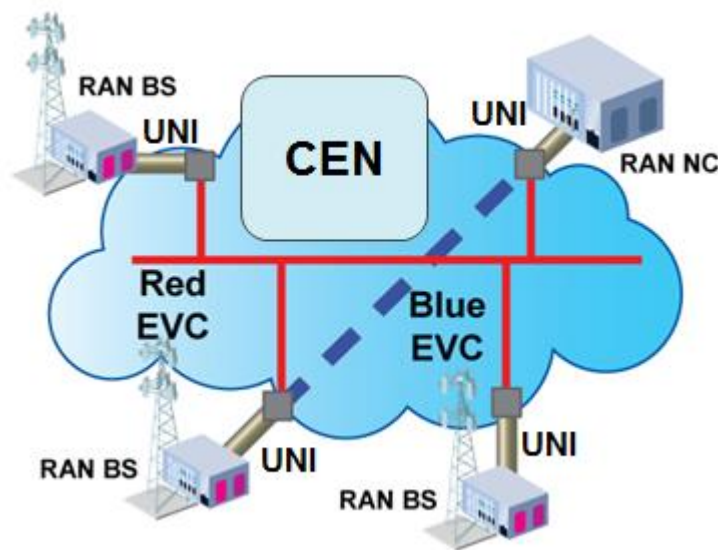

Figure 19: Ethernet Virtual Private LAN (EVP-LAN) Service

8.2.5 Ethernet Private Tree Service

Mobile Operators with multiple sites might use an EP-TREE (MEF 6.2 [3]) with 2 or more UNIs in the EVC. This type of service forces a leaf UNI to send and receive Service Frames to and from the root UNI and not to and from other leaf UNIs in the EVC. Such a configuration is useful when all traffic needs to go through 1 or more centralized sites designated as roots and all the remaining sites designated as leaves.

Traditionally in Mobile Backhaul the RAN BS sites only need to exchange Service Frames with the RAN NC site(s) and not with other RAN BSs. This behavior is possible in an Ethernet Private Tree (EP-Tree) service, where the RAN NC site(s) would be root(s) and the RAN BS sites would be leaves as shown in Figure 20.

The EP-Tree service is defined to provide All to One bundling, CE-VLAN ID preservation, CE-VLAN CoS preservation, and forwarding of key Layer 2 Control Protocols per MEF 45 [28]. A key advantage of this approach is that the Mobile Operator can configure VLANs across the sites without any need to coordinate with the Service Provider.

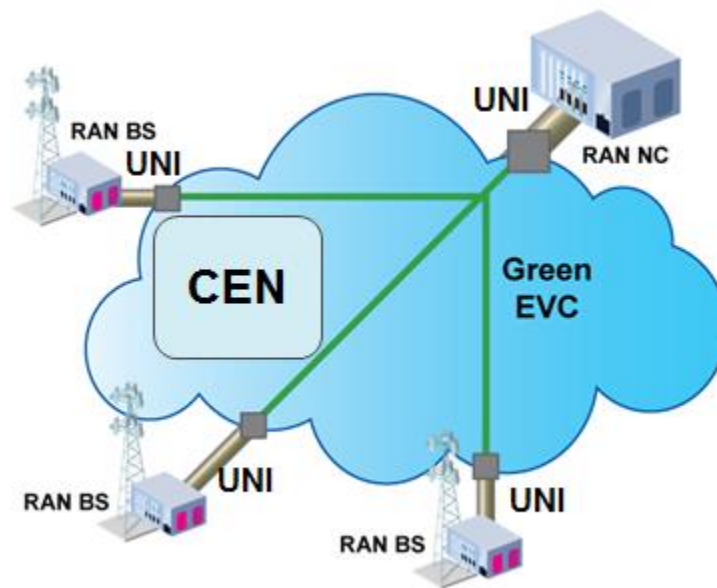

Figure 20: Ethernet Private Tree (EP-Tree) Service

8.2.6 Ethernet Virtual Private Tree Service

Some Mobile Operators desire to keep the root-leaf relationship between RAN NC and RAN BS sites, but also want to have Service Multiplexing with >1 EVC at one or more of the interconnected UNIs. For such cases, the EVP-Tree service (MEF 6.2 [3]) is used.

The CE-VLAN to EVC map and Bundling service attributes (MEF 10.3 [7]) are used at the UNIs. As such, CE-VLAN ID preservation, CE-VLAN CoS preservation, and forwarding of certain Layer 2 Control Protocols per MEF 45 [28] might not be provided. Figure 21 shows the basic structure of EVP-Tree service as green dashed line associating the UNIs. The other EVCs at a Service Multiplexed UNI can be Point-Point or Multipoint-to-Multipoint (red EVC shown) or Rooted-Multipoint EVC type. As an example, the EVP-Tree service can be used to transport mobile voice and data traffic while the EVP-LAN service offers an inter-site connection for node and site management.

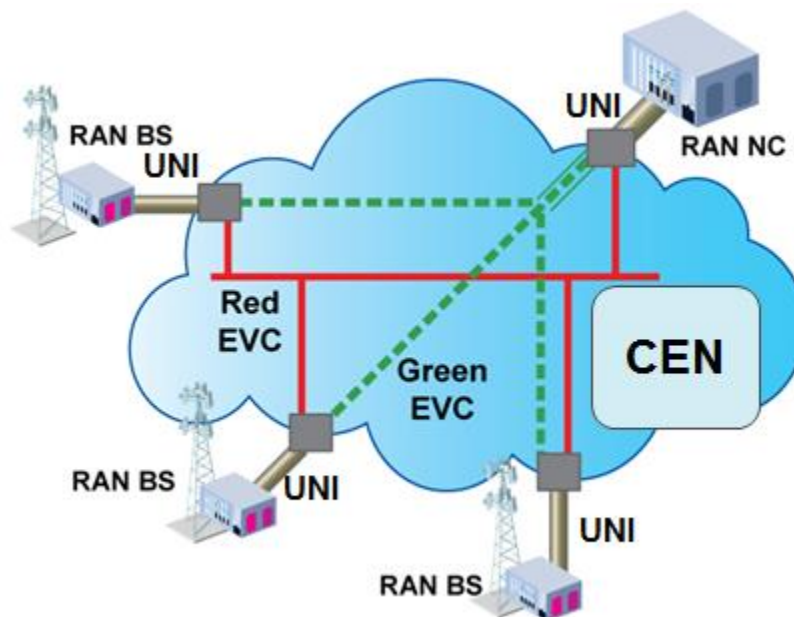

Figure 21: Ethernet Virtual Private Tree (EVP-Tree) Service

8.2.7 Use Case Variations

This section describes and provides examples of variations to use cases 1 and 2 for different Small Cells, including mixed CEN and IP MBH.

In all cases, the RAN BS can be relatively large (e.g., macro cell) or small (e.g., small cells such as micro, pico, femto). While use cases 1 and 2 can be applied to macro as well as small cell BS, use case 2b will be a common use case for small cells since small cells are relatively new and do not usually include TDM interfaces.

The addition of small cells will require an increase in backhaul capacity to the macro site (especially if small cells are aggregated there – see Appendix A.1) or providing new backhaul/midhaul to the additional small cell BS sites. The performance requirements on the backhaul/midhaul will be the same as macro only sites except in cases where the small cell radio technology requirements have been relaxed (e.g., less demanding requirements for peak rate demand, handover or service continuity) or in the case where some of the tight radio coordination features are to be used. In this tight coordination case, the performance requirements (e.g., delay, CIR/EIR and/or synchronization) might be more demanding. See section 4.1.1 for details on radio coordination.

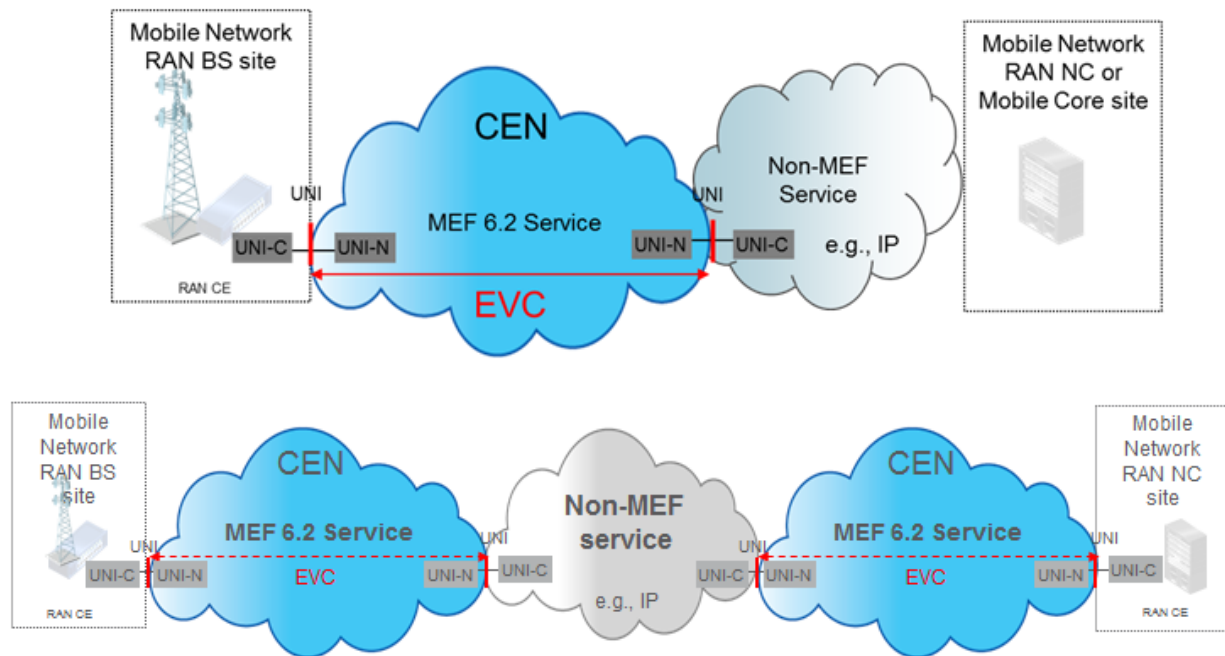

Figure 22: Use case examples with CEN and non-CEN hybrid

The use case examples in Figure 22 shows the MEF service closest to the base station as an extension of another non-MEF service – there may or may not be another MEF service at the RAN NC site. BBF TR-221 [89] and [90] explains this case in more detail for the non-MEF services. Note that this could also be deployed in the reverse case with non-MEF closest to the base station. The latter is expected to be prevalent in small cell deployments.

8.2.8 Use Case 3: RAN CE with Macro Backhaul Extensions to Small Cells

Use case 3 in Figure 23 illustrates a deployment option where extensions are made to existing backhaul connections to the macro site. In this case, the RAN CE equipment can be connected directly to the CEN with a MEF compliant UNI-C Ethernet, but there are two separate EVCs. The existing EVC(m) is shown on the right and a new EVC(sc) is shown on the left connecting the RAN CE of the macro site with the RAN CE of the small cell. Both EVCs use MEF 6.2 services and appear as entirely separate services to each CEN which may be from different CEN Operators.

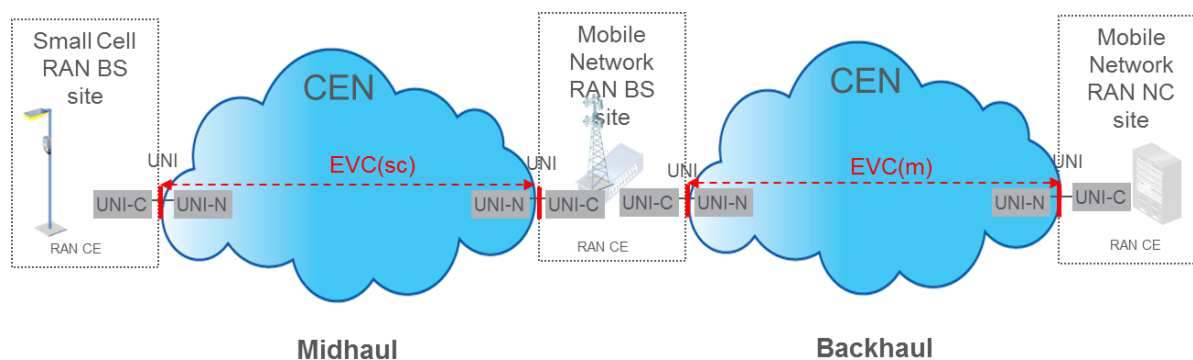

Figure 23: Use Case 3: small cell extension from macro

HetNet EVC(sc) midhaul can have different requirements than EVC(m) backhaul (see section 12.4.2 for delay budget differences). There are a number of options for the functions that could occur at the middle Mobile Network RAN BS site that are not normatively specified in this IA. For example, an aggregation router or a Ethernet switching device could be present which would allow relationships between single or multiple EVC(sc) with EVC(m) and might present options for implementing direct RAN BS to RAN BS traffic such as X2 for LTE (including the use of X2 for dual connectivity). The router or switching device would allow concentration of multiple small and macro cells onto EVC(m) for implementing traffic to the NC like S1 for LTE. The small cell RAN BS, like the macro cell RAN BS, may or may not be the device at the site with the UNI-C. If it is not, another device (router, switch or NID) would contain the UNI-C.

If separate frequencies are used for macro and small cells or if interference risk is low, there might not be significant difference other than capacity. However, if there is a risk of interference, the EVC(sc) midhaul might have different requirements, not only on capacity, but on delay and delay variation, to maximize the utilization of the radio resources using a tighter level of radio coordination. The constrained requirements on the backhaul/midhaul will thus be dependent on the level of radio coordination. Moderate coordination is addressed in section 12.4.2, and tight coordination in section 12.4.3. However, it is important to note that this small cell extension use case can realize several different RAN interconnection topologies for the LTE small cell. As shown in the Figures below, these are:

1. S1 only (Figure 24)
The midhaul EVC for the LTE small cell carries only LTE S1 traffic. This is transited at the macro base station site and is transported with the macro LTE S1 traffic over the backhaul EVC. The constraints are the same as for backhaul (e.g., PT1 per 12.4.2).
2. S1 and X2 (Figure 25)
The midhaul EVC for the LTE small cell carries LTE S1 and X2 traffic. The S1 traffic is transited as above, but the X2 traffic is only between cell sites. Radio coordination is supported and tight radio coordination will add constraints to the midhaul (e.g., constrained PT1 per 12.4.3)
3. X2 (Figure 26)
The midhaul EVC for the LTE small cell carries only LTE X2 traffic for dual connectivity (DC). This evolving 3GPP Release 12/13 feature [87] involves a split bearer

such that the small cell is directly connected to its master base station (see Appendix E). The constraints on this type of midhaul are the same as backhaul (e.g., PT1 or PT2 per 12.4.4).

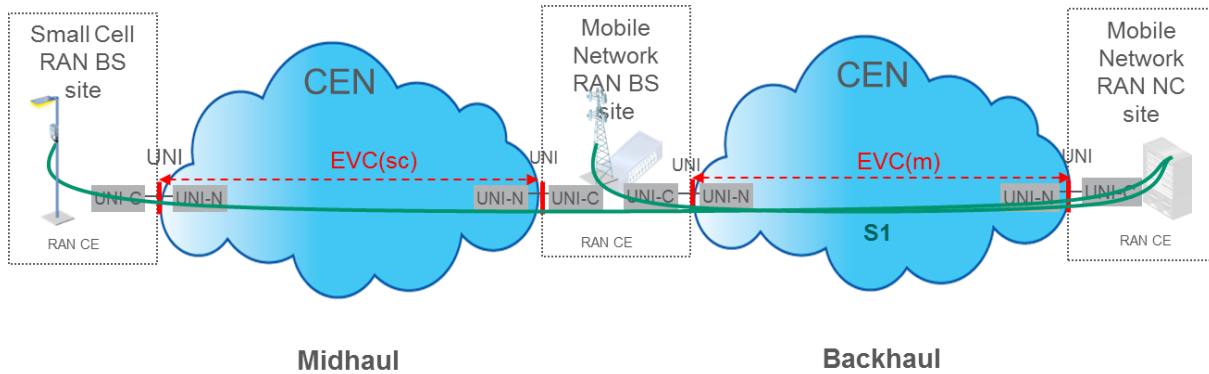

Figure 24: Use case 3a: Small cell extension for LTE S1 only

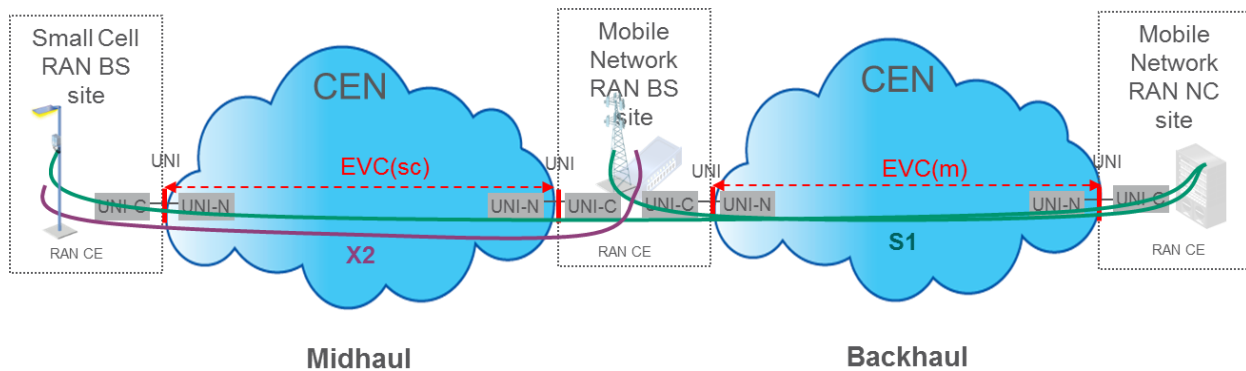

Figure 25: Use case 3b: Small cell extension for LTE S1 and X2 (radio coordination possible) only

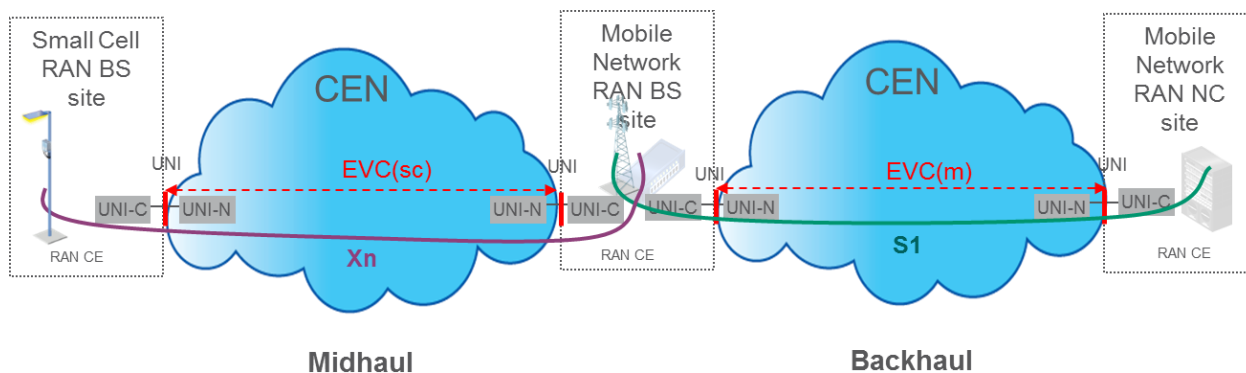

Figure 26: Use case 3c: Small cell extension for LTE X2 DC only

It should be noted that the LTE interfaces (S1, X2) will not be distinguishable at the UNI or to the CEN, unless the mobile operator maps one interface per bearer per EVC. The use cases highlight the varying CoS requirements. In some cases, the Mobile Operator is likely to provide the midhaul EVC(sc) themselves - depending on service availability – however, modeling the interconnection as an MEF service would still be useful (e.g., for planning or certification). These relatively short mobile backhaul needs would generally be prior to the CEN Operator’s first office or switching location and therefore dedicated transport is likely to be most common. Example cases include the Mobile Operator utilizing microwave Ethernet transport to provide this short midhaul, or the Mobile Operator acquiring wireline physical assets like dark fiber. Topologies that involve the transport of the frames to a central office switch and back to the Macro RAN BS site might not be cost or performance suitable.

8.3 Applying MEF Access Service Definitions to Mobile Backhaul

This section specifies the Mobile Backhaul Ethernet Access services. There are no changes from the baseline definition of MEF OVC Access Services in MEF 51 for use in this document.

- [R3] When a MBH Service is an association of UNIs and ENNIIs then the Operator of that CEN **MUST** meet the mandatory requirements of MEF 51 [29] for that service (either, Access E-Line or Access E-LAN).

A Mobile Operator is more likely to use VLAN based services in the multi-CEN context given the scalability of supporting many RAN BS sites with each UNI interface at a RAN NC site. There are two multi-CEN contexts that can be seen in Figure 27 below:

- Mobile Operator contracts with Service Provider to connect RAN BS & RAN NC who then may sub-contract to other providers to provide OVCs
- Mobile Operator is the Service Provider and contracts with multiple backhaul operators to connect its RAN BS & RAN NC

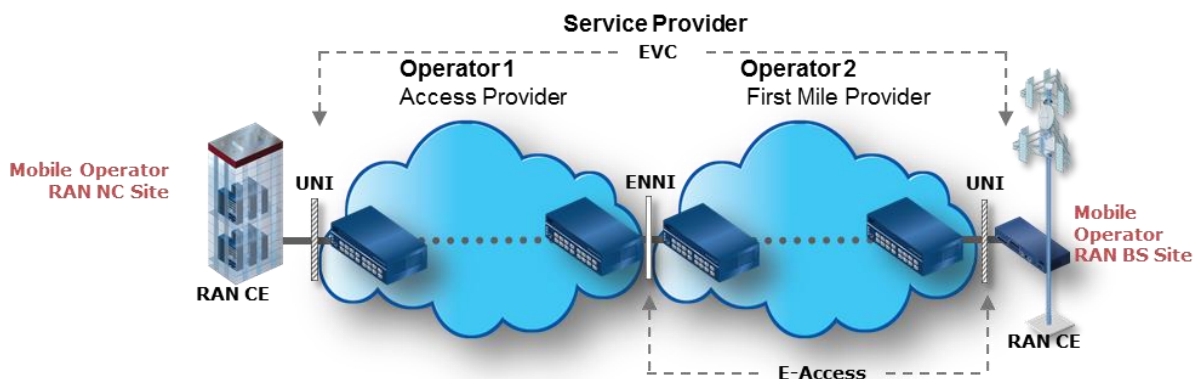

Figure 27: Example Application of OVC services to Mobile Backhaul

The OVC E-Access service could be used in previous use cases throughout this clause, resulting in numerous additional use case situations. For additional guidance, see Appendix F.

8.3.1 Access E-Line Service

The Access E-Line Service provides a Point-to-Point OVC connecting one UNI with one ENNI.

8.3.2 Access E-LAN Service

The Access E-LAN Service provides a Multipoint-to-Multipoint OVC connecting one or more UNIs with one or more ENNIs.

9. Management Model for Mobile Backhaul Service

This section specifies the OAM model for FM and PM for a MBH service across a single CEN domain.

9.1 Ethernet OAM

Ethernet OAM is a term used in this IA to collectively refer to Link OAM (MEF 20 [17]) and SOAM (MEF 17 [15] and MEF 30.1[25] and MEF 35.1[26]). Ethernet OAM requirements are not specified in any current mobile standards from 3GPP, 3GPP2 or IEEE Std. 802.16. RAN CEs with legacy TDM or ATM interfaces for Mobile Backhaul implemented SONET or SDH and also ATM OAM. RAN CEs with Ethernet interfaces supporting UNI-C and CENs supporting UNI-Ns for Mobile Backhaul can implement Ethernet OAM.

Ethernet OAM is desirable for fault management, connectivity management, and performance monitoring of the Mobile Backhaul Service as well as the UNI. The UNI-C with SOAM capability could measure performance using the Subscriber Maintenance Entity Group (MEG).

Link OAM and Service OAM are OAM mechanisms with similar fault management capabilities, but operate on different network layers. Link OAM monitors the TRAN Layer (MEF 12.2 [11]) by running Link OAM frames between the UNI-C and UNI-N. Service OAM, on the other hand, monitors the ETH Layer (Ethernet Services Layer in MEF 12.2 [11]) and can span one or multiple Ethernet Links. Service OAM can also be configured to monitor the link between the UNI-C and UNI-N. Typically either Link OAM or Service OAM are used to monitor the UNI, but not both, as this can potentially introduce contradictory measurement results.

[O2] The Mobile Backhaul Ethernet Service **MAY** support a value of *Enabled* for Link OAM Service Attribute.

It should be noted that when the term ‘support’ is used in a normative context in this document, it means that the SP is capable of enabling the functionality upon agreement between the Mobile

Operator (Subscriber) and the SP. MEF 6.2 [3] follows guidance from Sec 9.1 of MEF 30.1 and recommends using UNI MEG instead of Link OAM when UNI Resiliency is Enabled.

See Section 11.1 for UNI Types. UNI Type 2.1 has Link OAM as a ‘MAY’ in R5 of MEF 20 [17]. Also, Link OAM is recommended to be supported for UNI Type 1 as well. Enabling or disabling Link OAM is also reflected in the Link OAM service attribute of MEF 10.3 [7]

9.2 Service OAM

The Mobile Backhaul network’s FM and PM reference model for SOAM is illustrated in Figure 28 below. The figure shows the reference model for Service and SOAM for FM as well as PM. SOAM for an EVC across two Operators is shown in Figure 1 of MEF 30.1 and SOAM with Super Operator is discussed in Appendix D of MEF 51.

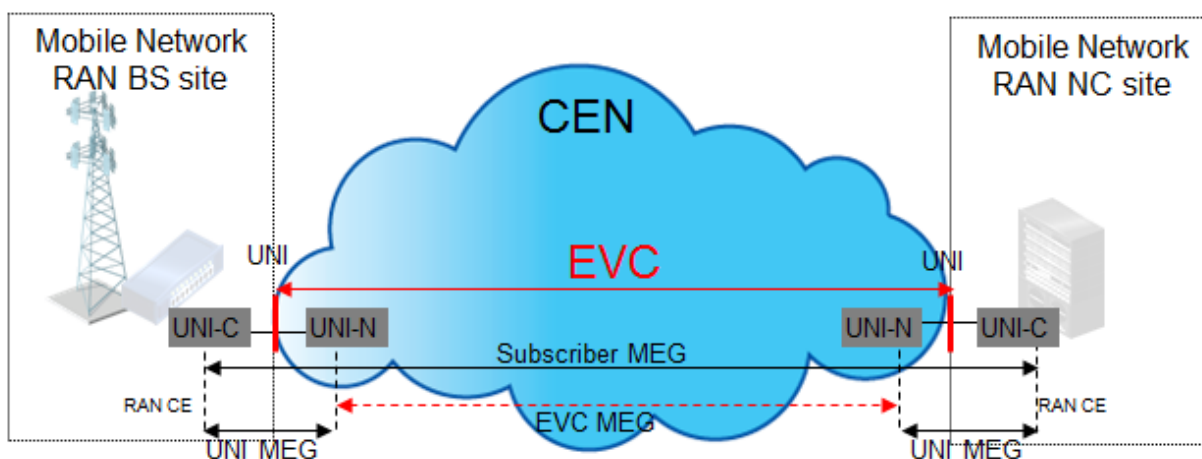

Figure 28: FM and PM Reference Model for Use Case 2

Figure 28 shows a Point-to-Point EVC type between RAN BS and RAN NC sites. However, this FM and PM model also applies to other EVC types and for EVCs between RAN BS sites only or between RAN NC sites only. SOAM (MEF 17 [15] and MEF 30.1 [25] and MEF 35.1 [26]) is used on the different service components (UNI, EVC) by Mobile Operator as well as CEN Operator. For an EVC that has N UNIs in the EVC there are many ordered pairs and a subset of ordered UNI pairs (MEF 10.3 [7]) might have SLS objectives. So, FM and PM might be performed on that subset.

MEF 17 [15] and MEF 30.1 [25] specify the MEGs to use for FM and PM. A CEN Operator can use all or some of the MEGs for FM and PM. For example, the TEST MEG might be used at the time of initial service activation of the Mobile Backhaul Service. The MEGs for which FM and PM requirements can be applicable in Mobile Backhaul are illustrated in the figure. These are defined in MEF 17 [15] and MEF 30.1 [25] and MEF 35.1[26]:

- UNI MEG (between UNI-C and UNI-N),

- EVC MEG (between peer UNI-Ns), and
- Subscriber MEG (between peer UNI-Cs, i.e., End-to-End Flow or Subscriber Ethernet Connection (EC) as defined in MEF 12.2 [11])

These are described in MEF 30.1 [25], MEF 20 [17], and MEF 51 [29] and are reflected in the UNI MEG and Subscriber MEG MIP service attributes of MEF 10.3 [7]. Additional MEGs such as SP and ENNI MEGs can be applicable when there are 2 or more Operators. Some of the MEGs are also captured as attributes of MEF 6.2 [3] and MEF 51 [29] Services. A UNI type 1 implementation might have the capability to support SOAM although not specified in MEF 13 [12]. However, a UNI Type 2 implementation will have capability to support SOAM per MEF 20 [17].

[R4] If the Mobile Operator (Subscriber of Mobile Backhaul service) uses SOAM to monitor service then Subscriber MEG level, as defined in MEF 30.1 [25] or MEF 51[29], **MUST** be used.

MEF 51 provides more detailed requirements for multi-CEN networks. A Mobile Operator could use the Subscriber MEG for fault management and to measure performance metrics such as FLR for the Subscriber EC between RAN CEs. This can help determine the condition of the connectivity among peer UNI-Cs. The RAN CE can use this information to perform transport resource management for user and signaling traffic as suggested in Section 4.3.3 of the NGMN Alliance specification [102]. The specific methods for transport resource management by a RAN CE are outside the scope of this IA.

[R5] If the CEN operator uses SOAM at the service level then the EVC, SP or Operator MEG level, as defined in MEF 30.1 [25], **MUST** be used.

MEF 51 [29] has additional requirements for OVC Services and applicable when a Mobile Backhaul Service uses 2 or more Operators.

[R6] If SOAM is used to monitor ENNI then the ENNI MEG level, as defined in MEF 30.1 [25], **MUST** be used.

The UNI MEG is for monitoring the status of the physical connectivity between the RAN CE instantiating the UNI-C functions and the CEN NE instantiating the UNI-N functions.

[R7] If SOAM is used to monitor the UNI then the UNI MEG level, as defined in MEF 30.1 [25], **MUST** be used.

MEF 6.2 [3] recommends that SP support Subscriber MEG MIP.

Also, when UNI has 2 links then MEF 30.1 [25] recommends that UNI MEG attribute is LAG MEG and that each link could be monitored with LAG Link MEG.

Furthermore, with UNI Type 2 [17] the RAN CE can be notified of EVC status using E-LMI protocol (MEF 16 [14]) so the transport modules in the RAN CEs (eNB and aGW) can apply

necessary transport resource management as suggested in Section 4.3.3 of the NGMN Alliance specification [102]. The specific methods for transport resource management by a RAN CE are outside the scope of this IA.

The MEPs and MIPs for these MEGs are the provisioned SOAM reference and measurement points to initiate and terminate SOAM frames, as appropriate, for FM and PM (MEF 17 [15], MEF 30.1[25], MEF 35.1[26] MEF 12.2[11]). As an example, the PM metrics for the EVC are defined UNI to UNI (MEF 10.3 [7]). To perform PM measurements for the EVC, the CEN operator will need to provision the MEPs for the EVC MEG at the NEs supporting UNI-N functions close to the UNI demarcation point.

As specified in D1 of MEF 51 [29], when a MEP is enabled for a MEG that is not completely contained within a single Operator's CEN, the Operator **MUST** support PM-1 as specified in MEF 35.1[26] at the MEP.

10. Resiliency related Performance Attributes for EVC

Service Resiliency performance attributes allow a CEN Operator to offer MEF Services that are resilient to failures that affect UNI or EVC with limits on the duration of short term disruptions and to apply constraints like diversity. Service Resiliency performance depends on the capabilities of the components of the Service: EI (UNI) and the EVC that associates the EIs.

The Mobile Operator can request the CEN operator to support appropriate performance attributes in the SLS for the EVC, i.e., per CoS ID (MEF 10.3 [7]) in addition to choosing a UNI Type for implementation of the UNI. The Service model along with FM and PM reference model shown in Figure 28 is used in defining resiliency requirements for the UNI and the EVC in the context of a Mobile Backhaul Service.

In use cases such as LTE or WiMAX, the EVC type can be different, as discussed in Section 8.2, for X2 and/or S1, or WiMAX R6 and R8, and there might be different performance considerations for X2/R8 or S1/R6 interfaces. S1-flex architecture, discussed in Section 5, could be designed with two RAN NC UNIs in one E-LAN or E-Tree service. A SLS could then be defined where failure of one RAN NC UNI would still allow the EVC to be in Available state. In addition, there might be a need for the CEN to notify RAN CEs of the status of the EVC if the EVC is partially Available (e.g. one RAN NC UNI in the EVC is in failure state).

UNI Resiliency requirements are in Section 11.3 and EVC Resiliency performance in terms of PM attributes is in Section 12.3.1 and 12.3.2.

10.1 Short Term Disruptions

The resiliency performance attributes defined in MEF 10.3 [7] are High Loss Interval (HLI) and Consecutive High Loss Intervals (CHLI) in addition to Availability objective for a given CoS Name. HLI and CHLI can be important to Mobile Operators since short term disruption in the CEN can result in much longer term disruption in the Mobile services (e.g., loss of required

signaling and control can cause re-initialization). The NGMN Alliance identifies a Service Continuity time (in Section 5.2.1) [102] for a mobile user equipment to disconnect and specifies a range of 500ms-2s. Since this includes both the radio link to user and Mobile Backhaul segments the short term disruptions in the CEN, if any, might need to be smaller than the range mentioned in the NGMN Alliance specification [102]. The duration of any disruption as seen by a RAN CE can be smaller than the CHLI for a given CoS Name if the CEN domain or the RAN CEs have mechanisms to recover faster from such disruptions. Such mechanisms can help in achieving a target of 50ms-250ms switching time to an alternate aGW (RAN NC) site as recommended in Section 5.2.1 of the NGMN Alliance specification [102] since 3GPP specifications allow for S1-flex (3GPP 23.236 [72]).

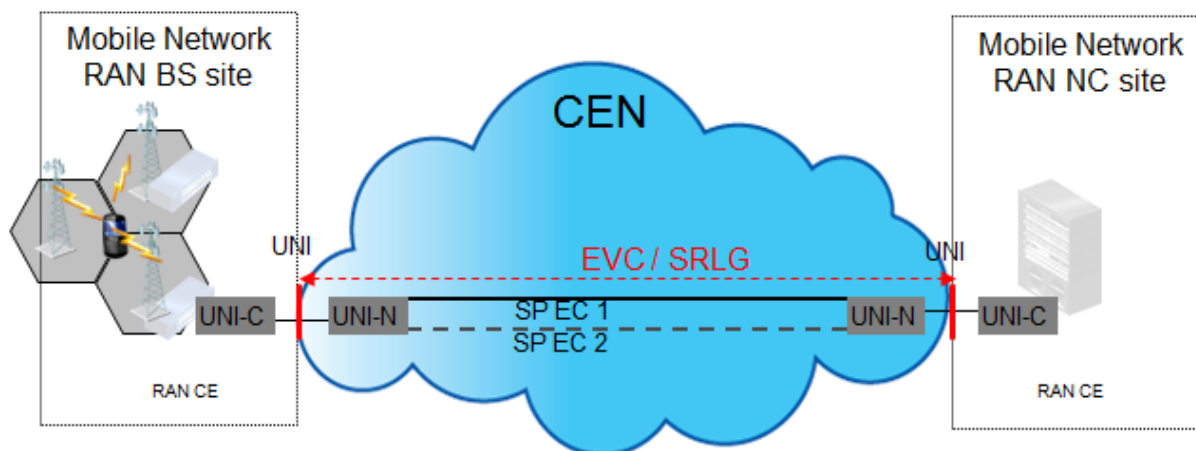

Figure 29: Association of EVC to two SP ECs for improved resiliency

Availability objective for the EVC can be used by a CEN Operator to design the required number of SP ECs [11] to which an EVC can be associated in the CEN. For example, if an EVC is requested with lower Availability, such as for a MEF CoS Label L in MEF 23.1 [20], then the CEN Operator can associate the EVC with one unprotected SP EC. A high frame loss event of the SP EC or failure of EIs in the EVC for $\{n \times \Delta t\}$ intervals or more (MEF 10.3 [7]) will transition the EVC to Unavailable state until such time the fault condition is repaired. On the other hand when higher Availability is required then the EVC can be associated with 2 or more SP ECs so as to maintain service performance by choosing one of the working SP EC, with none or minimal disruptions to the service, during fault conditions in the CEN.

With HLI and CHLI attributes the CEN operator can also quantify the number of such short term disruptions, if any, to the service. It is also possible to evaluate the duration of disruptions using HLI or CHLI information in a given measurement period (MEF 10.3 [7]). Such objectives on HLI or CHLI counts can be included in the SLS for the EVC. For example, a Mobile Operator could have an objective of ≤ 10 per month for CHLI events. A p-CHLI event might have been defined with $p=2$ for 2 or more consecutive high loss intervals but $< n$ consecutive time intervals used to determine transition from Availability to Unavailability (MEF 10.3 [7]). Thus, a 3 second duration of disruption would result in one CHLI and count toward an objective of ≤ 10 per month. The Operator might need to choose both an Availability Δt interval and flr threshold

combination to determine a HLI that is of the order of duration of disruption. This will allow correlating the count of HLI or CHLI events with the number of disruption events, if any, during the measurement period.

A CEN domain might have mechanisms to recover from high loss events. If there is sufficient frame loss during any failure recovery processes at the service level (eg. CoS Name) then the time intervals will register as high loss intervals (or even as a CHLI). Such processes might include selection of an alternate EC and updating resource allocation in NEs including forwarding rules along the failed and alternate paths. The mechanisms might be in the ETH layer to select an alternate EC or in the TRAN layer (MEF 4 [2]) and are out of scope for this IA.

10.2 Diversity

As discussed in Section 10.1 a CEN Operator can maintain service performance for an EVC, during fault conditions in the CEN, using multiple ETH layer connections or TRAN layer connections in the CEN. The Availability performance of the EVC is improved if there is at least one connection, within the CEN, that is fault free to support the EVC. This is much more likely if the connections supporting an EVC have diversity constraint with different Shared Risk Groups (SRGs). Shared Risk Group (SRG) is a set of NEs that are collectively impacted by a specific fault or fault type (RFC 3386 [96], in Section 2.2.2). In this IA this is referred to as facility SRG where facility refers to NEs owned by an Operator and can also include Fiber links. In this case the CEN Operator is responsible to minimize the short term disruptions for the EVC with mechanisms to recover from high loss events by selecting a diverse connection. The duration of such short term disruptions, if any, is reported with HLI, CHLI and A in the SLS. This is categorized as CEN Resiliency in this IA.

A CEN operator can likewise ensure diversity between EVCs by using different SRGs such that at least 1 EVC is not impacted by a specific fault or fault type. The CEN Operator will have an SLS with resiliency performance attributes, i.e., HLI, CHLI and A, to report the duration of short term disruptions in each EVC. The CEN Operator is not required but can choose to use additional mechanisms within the CEN to minimize the short term disruptions for each EVC. This is categorized as RAN Resiliency in this IA.

A Mobile Operator typically has certain performance targets that it measures for its user equipment, i.e., equipment internal to Mobile Operator network. One of these can be resiliency and this is often a function of the handoff between the multiple RAN BS that the user equipment has access to. A Mobile Operator might use the fact that there are multiple RAN BS available for user equipment to stay connected – this is categorized as Radio Resiliency in this IA. While the details of Radio Resiliency are out of scope for this IA, the Mobile Operator might leverage features of CEN Resiliency or RAN Resiliency to improve its overall Radio Resiliency performance.

10.2.1 ETH-layer Diversity

The Ethernet Services layer, or ETH Layer, refers to the Ethernet networking layer defined by the MEF to specify Ethernet oriented connectivity services (MEF 12.2 [11]). MEF services have PM defined for a set, S , of ordered UNI pairs (MEF 10.3 [7]) and objective for the Set S (e.g., A_T^S for Availability) is specified for an interval T (e.g., 30 days). Such a set might contain all or some subset of ordered UNI pairs in the EVC. For an E-Line (EPL or EVPL) there are two ordered UNI pairs (i.e., both directions of an EVC). In most use cases an operator might choose to have both ordered UNI pairs in one set and so the SLS is then specified for that one set.

For an E-LAN or E-Tree there are many ordered UNI pairs which can be grouped in one set or multiple sets of ordered UNI pairs. If all ordered UNI pairs are in one set then a fault might impact all ordered UNI pairs in the set and the EVC will then transition to Unavailable state. The fault can be at a UNI or anywhere in the CEN. With multiple sets a CEN Operator has SLS for each set but can additionally specify that the EVC is considered to be in Available state when at least one set is in fault free condition. A typical example in Mobile Backhaul service would be where there are 2 RAN NC UNIs in the EVC (e.g. dual rooted E-Tree) but now each RAN NC UNI is in a different set of ordered UNI pairs. This allows the RAN BS sites to maintain connectivity with at least one RAN NC site. The Mobile Backhaul service is more likely to have at least one set to be in fault free condition if the sets are diverse.

Diversity can be a constraint between sets of a given EVC or sets across two or more EVCs. However, each set has ordered UNI pairs with UNIs in the EVC. The Set S , of ordered UNI pairs $\langle i, j \rangle$ with $\{m\}$ UNIs in the EVC, is defined as the ETH-layer SRG (ESRG) attribute where

$$S = \subseteq \{ \langle i, j \rangle \mid i = 1, 2, \dots, m \ \& \ j = 1, 2, \dots, m \ \text{with} \ i \neq j \} \quad \text{Equation 1}$$

- [R8]** If diversity in the ETH layer is required then the requirements [R9] to [R12] **MUST** apply.
- [O3]** If diversity in the ETH layer is required then the requirements [O4] to [O5] **MAY** apply.

TRAN layer (MEF 12.2 [11]) diversity is forced by the need for ETH layer diversity, i.e., if two sets are to be diverse in each TRAN layer link or NE then the diversity test is done in each such TRAN layer link or NE.

- [R9]** Set S **MUST** have ordered UNI pairs with UNIs in the EVC as defined in MEF 10.3 [7].

The set S has performance metrics defined in the SLS for a CoS Name uniquely identified by the triple $\{S, \text{CoS ID}, \text{PT}\}$ as defined in MEF 23.1 [20], i.e., set S with specific CoS ID across a specific PT. The Set S can be a subset of all ordered UNI pairs in the EVC as specified in MEF 10.3 [7].

- [R10] Set S **MUST** be selected such that the elements of the set are collectively impacted by a specific fault or fault type in the CEN.

The fault that impacts Set S will affect the performance for the CoS Name identified by the triple $\{S, \text{CoS ID}, \text{PT}\}$.

- [R11] The minimum number of sets $\{S_k \mid k=1,2,\dots\}$ to be evaluated for diversity **MUST** be 2.

- [O4] The sets $\{S_k \mid k=1,2,\dots\}$ **MAY** be from 1 or more EVCs.

Each set S_k , with ordered UNI pairs, now has a set of UNIs in that set:

$$U_k \subseteq \{i \mid i=1, 2, \dots, m\} \quad \text{Equation 2}$$

A UNI Overlap attribute $O(S)$ is defined to identify if there are any common UNIs present in the group of sets $\{S_k \mid k=1,2,\dots\}$. So, set S_i with U_i and set S_j with U_j are said to be diverse in the ETH layer if they do not have common UNIs and is mathematically represented as follows:

$$O(S) = \{U_i \cap U_j = \emptyset \mid i \neq j\} \quad \text{Equation 3}$$

The values for $O(S)$ are ‘null’, i.e., no overlap, or ‘not null’, i.e., overlap exists between sets.

- [R12] A Mobile Operator **MUST** specify the sets $\{S_k\}$ for each CoS Name identified by the triple $\{S, \text{CoS ID}, \text{PT}\}$ for which the $O(S)$ condition needs to be met at each facility SRG.
- [R13] If two sets are to be fully diverse then $O(S)$ **MUST** be a “null” set in each of the facility SRG in the CEN.
- [O5] If two sets are to be partially diverse then $O(S)$ **MAY** be “not null” set (i.e., can have common UNIs) in 1 or more facility SRGs in the CEN.

10.2.2 Group Availability

MEF 10.3 [7] has specified performance metrics for Group Availability using the subset from a single EVC or the subset from multiple EVCs.

11. UNI Requirements

This section specifies requirements for UNI in addition to providing a recommended approach to supporting resiliency and synchronization services.

The UNI requirements might not be uniform for all UNIs in the Mobile Backhaul. This document distinguishes the requirements for the UNI at the RAN BS and the UNI at the RAN

NC, as illustrated in the Service Model of Figure 15, when necessary. Requirements specified for the UNI apply to both the RAN BS UNI and RAN NC UNI, unless specified otherwise.

RAN BS and RAN NC can each be considered as a single device, such as a base station or network controller/gateway, or site with several network devices. As per MEF 11 [10], it is assumed that the UNI-C or UNI-N functions can be distributed across one or more devices.

11.1 UNI Scalability

- [R14] The CEN operator **MUST** support at least 2 EVCs at a RAN BS UNI for VLAN based Services.
- [D3] The CEN operator **SHOULD** support at least 4 EVCs at a RAN BS UNI for VLAN based Services.
- [O6] The CEN operator **MAY** support minimum number of EVCs per MEF 13 [12] at a RAN BS UNI for VLAN based Services.
- [R15] The CEN operator **MUST** support minimum number of EVCs per MEF 13 [12] at a RAN NC UNI for VLAN based Services.

MBH Service can support configuration of CIR and EIR in granularities mentioned in Section 6.2.5 of UNI Type 1 (MEF 13 [12]). The NGMN Alliance has recommended values (in Section 4.2) [102] for granularities for Peak and Average Bandwidths. Ignoring the differences in terms used, such as Peak Bandwidth, a MEF compliant UNI or ENNI can support granularities as in the following Table.

Granularity Range	MEF compliant UNI or ENNI	NGMN [95]
Up to 10Mbps	1Mbps	
Up to 30Mbps		2Mbps
10-100Mbps	5Mbps (MEF 13) 10Mbps (D6, D11 of MEF 51)	10Mbps
100Mbps – 1Gbps	50Mbps (MEF 13) 100Mbps (D6, D11 of MEF 51)	100Mbps
> 1Gbps	500Mbps 1Gbps (D6, D11 of MEF 51 – OVC Services)	100Mbps

Table 2: Granularity of UNI bandwidth rates

Furthermore, the UNI at RAN CE will need to properly account for the differences in how Peak, Peak Access, Effective and Average Bandwidth, terms mentioned in the NGMN Alliance specification [102], are calculated as compared to the Ingress and Egress Bandwidth Profile parameters defined in MEF 10.3 [7] for the CoS Name at the UNI. It is critical, however, to

clarify that MEF's Bandwidth Profile parameters at the UNI are defined based on the Service Frame at the UNI (MEF 10.3 [7]). It is not possible for this IA to provide recommendations since there are no precise definitions for the terms used in the NGMN Alliance specification [102] and a RAN CE might additionally employ header compression for the IP Packets.

11.2 GIWF's UNI Requirements

Use case 1a in Section 8.1.1 has a SP delivering Mobile Backhaul service at a TDM demarcation using a GIWF with TDM interface to the RAN CEs. The SP uses a CEN for some or all traffic between TDM-interface based mobile equipments in the RAN BS and RAN NC. Requirements on a GIWF's UNI are dependent on UNI as discussed in Section 11.1.

[R16] The GIWF's UNI **MUST** comply with all requirements, for the UNI implemented, as defined in this IA.

This IA is agnostic to the mechanisms used to adapt TDM-interface based RAN BS and RAN NC to MEF defined services across a CEN. Requirements specific to CES across the CEN are defined in MEF 3 [1], MEF 8 [4] and BBF TR-221 [89] and are out of scope for this IA.

11.3 UNI Resiliency

A CEN operator can support UNI implementations to enable Services or Synchronization architectures that are resilient to some UNI failure scenarios. One example is Link Aggregation [17] for port protection or line card protection. In addition, there might be the option to have multiple UNIs to the same RAN CE site where UNIs can be on the same NE or different NEs. MEF10.3 Amendment - UNI Resiliency Enhancement [9] adds All-Active which is useful for MBH. Typically, it is expected that the RAN NC site might have more complex implementations than RAN BS sites.

[D4] The Mobile Backhaul Ethernet Service at a RAN NC site **SHOULD** have a value of either 2-Link Active/Standby or All-Active for UNI Resiliency Service Attribute at a RAN NC site.

[O7] The Mobile Backhaul Ethernet Service at a RAN NC site **MAY** have a value of either 2-Link Active/Standby or All-Active for UNI Resiliency Service Attribute at a RAN BS site.

Implementations such as Link Aggregation with >2 links are specified as 'other'.

[R17] When more than 1 link is implemented for UNI Resiliency then the links **MUST** terminate on different line cards for a UNI at the RAN NC site.

IEEE Std. 802.1AX™ [32] uses the terms Selected, Unselected or Standby. A link in Selected state is used to send/receive frames. A link when Unselected is not part of Link Aggregation Group. A link in Standby is not used to send/receive frames. In the case of Link Aggregation with exactly 2 links for the UNI the Selected link is said to be active for all CoS Names at the UNI.

In addition to line card diversity there might be a need to enhance the resiliency to failure by specifying additional constraints such as UNI overlap for diverse sets of ordered UNI pairs as defined in Section 10.2.1.

11.4 UNI PHY for Synchronization Service

This section specifies Synchronous Ethernet capability so that the CEN operator can offer a Synchronization Service typically with a PRC traceable frequency reference towards the Mobile Operator's RAN BS sites. The case when a Mobile Operator owns the PRC is for further study.

[O8] The Mobile Backhaul Ethernet Service **MAY** have a value of Enabled for Synchronous Mode Service Attribute, as specified in MEF 10.3 [7], to deliver a PRC traceable frequency reference to the RAN BS site.

It is expected that the CEN Operator will enable Synchronous Ethernet with or without Ethernet Synchronization Message Channel (ESMC) (ITU-T G.8264 [43]) at specific RAN BS sites when needed. ESMC is a protocol used to indicate the quality level of the clock. There are two aspects to consider:

1. UNI PHY can operate in Synchronous mode, and,
2. UNI PHY operating in Synchronous mode with ESMC support and with or without QL indication for PRC traceability

[R18] If Synchronous Ethernet is used for frequency synchronization service at the RAN BS UNI then the requirements [R19] to [R28] **MUST** apply.

11.4.1 UNI PHY with Synchronous mode

UNI operates as Full Duplex with Synchronous or Asynchronous modes. Asynchronous mode refers to interface operating with physical layer frequency as specified in IEEE Std. 802.3™-2008 [33] e.g., transmit clock frequency of 125MHz +/-0.01% for 100BASE-SX interface. In ITU-T G.8264 [43] this is referred to as Non-synchronous operation mode (on the transmit side). Synchronous operation mode (ITU-T G.8264 [43]), on the transmit side, refers to the case when the frequency is driven from the Equipment Slave Clock (EEC). Such an operation mode, however, might not have the EEC locked to any external clock source.

[R19] Synchronous Mode attribute **MUST** be set to a value of Disabled for each link in the list of UNI PHY and with each link operating as shown in Table 3.

Administrative Action	Synchronous Mode
Disabled (Default)	Full Duplex Asynchronous mode with ESMC and QL process disabled
Enabled	Full Duplex Synchronous mode

Table 3: Synchronous Mode

11.4.2 ESMC Protocol (L2CP) on UNI PHY

The protocol uses the slow protocol address as specified in Annex 57B of IEEE Std. 802.3-2008 [33] and no more than 10 frames per second can be generated for all protocols using slow protocol address. ESMC frames are sent at 1 frame per second.

- [R20] A Mobile Backhaul Ethernet Service **MUST** be as per R17 and R18 of MEF 45 [28] when Synchronous Mode attribute has a value of Enabled.
- [R21] The ESMC Frame format **MUST** be as specified in ITU-T G.8264 [43].
- [R22] If Synchronous Mode attribute has a value of Enabled then ESMC protocol processing **MUST** be enabled by default as shown in Table 4.

Administrative Action	ESMC processing
Disabled	Transmit: No generation of ESMC Frames Receive: discard ESMC Frames if any received due to misconfiguration errors, for example.
Enabled (Default)	Transmit: Generate ESMC Frames Receive: Peer ESMC Frames

Table 4: ESMC Protocol

The terms transmit and receive are used in this IA since the requirements apply to CEN and RAN CE. MEF 10.3 [7] uses ingress and egress but this is always with respect to CEN, i.e., ingress is towards CEN and egress is towards CE.

- [R23] UNI with Synchronous Mode attribute value of Enabled, and with ESMC enabled as shown in Table 4, **MUST NOT** be a selectable clock source for the CEN.

While a RAN CE UNI in synchronous mode will be compliant to [R27] the requirement [R23] is to ensure that under any condition the direction of clock distribution is from CEN to a RAN BS. When ESMC is disabled the actual frequency of the UNI PHY can still be driven from the EEC if in Synchronous mode. See Section 10.2 in ITU-T G.8264 [43] for non-synchronous operation mode.

This IA has specified the option of using Link Aggregation for UNI resiliency in Section 11.3 with exactly 2 links. Both Link Aggregation and ESMC use slow protocols. However, Link Aggregation operates above any other IEEE 802.3 sublayer, (IEEE Std. 802.1AX-2008 [32]) including the ESMC. In fact the OAM sublayer presents a standard IEEE Std. 802.3 MAC service interface to the superior sublayer. Superior sub-layers include MAC client and Link Aggregation. Furthermore, a Synchronous Ethernet link and associated ESMC and QL remain independent of Link Aggregation state being in Selected/UnSelected/Standby.

When both physical links in the Link Aggregation are configured to be in Synchronous Ethernet operation mode, with ESMC enabled carrying its own ESMC channel and related QL, then the configuration needs to be consistent for both links. Further considerations on the implications of having multiple SyncE links, with or without Link Aggregation, are described in ITU-T G.8264 Amd 1 [44]. It is left to the CEN operator to configure several synchronous Ethernet enabled ports or only one synchronous Ethernet enabled port of the LAG.

11.4.3 QL process support on UNI PHY in Synchronous mode

QL is used to design the synchronization network in order to properly handle fault conditions. In particular, QL can help in prevention of timing loops. In a typical deployment it is expected that the timing distribution is unidirectional (i.e., CEN to RAN BS).

[R24] The QL process, with ESMC enabled, **MUST** support states as shown in Table 5.

Administrative action	QL Indication
QL Disabled	Transmit: Set QL TLV=DNU or DUS
ITU-T G.781 [49]	Receive: Ignore QL TLV
QL Enabled (Default)	Transmit: Set QL TLV
	Receive: Process QL TLV

Table 5: QL process support in Synchronous operation mode

[R25] UNI with Synchronous Mode attribute value of Enabled, and with ESMC protocol enabled as shown in Table 4, **MUST** have QL process enabled by default as shown in Table 5.

[R26] The QL mode of operation at UNI **MUST** be configurable by administrative methods, i.e., using a NE's management interface.

[R27] UNI with Synchronous Mode attribute value of Enabled, and with ESMC protocol enabled as shown in Table 4, **MUST** set QL TLV=DNU or DUS per ITU-T G.781 [49] in ESMC frames transmitted towards CEN.

[R28] If QL process is disabled, with ESMC protocol enabled, at a CEN's UNI PHY for any operational reason then ESMC frames **MUST** be sent by CEN's UNI with QL-TLV=DNU or DUS (ITU-T G.8264 [43]).

In some deployments there might be UNI designs with >1 UNI to the same RAN BS site. With >1 UNI a CEN operator could provide clock distribution from multiple PRC sources so the RAN BS can use QL to select the highest traceable clock. This would be useful if for some reason a traceable reference is lost on one UNI.

Furthermore, even with 1 UNI to a RAN BS site, QL value with a DNU message can allow a RAN CE's UNI to go in to hold-over mode until such time the fault condition (absence of traceable reference) is corrected. More importantly, RAN CE's UNI will use its internal clock source and not synchronize to the holdover clock of the CEN nodes that could potentially be lower quality than its internal clock source.

However, ITU-T G.8264 [43] allows certain applications, such as in access networks, where a RAN CE's UNI might be able to recover frequency from the Synchronous Ethernet interface without needing to process ESMC or QL.

A CEN's UNI will need to be capable of generating Ethernet Synchronization Messaging Channel (ESMC) messages assuming RAN CE's UNI requires a traceable frequency reference and clock quality indication. Also, all values of QL as specified in ITU-T G.781 [49] will need to be supported. The requirements are to ensure that CEN NEs supporting UNI-N at RAN BS are capable of Synchronous Ethernet with support for QL mode of operation if a RAN CE's UNI is capable of processing the messages. Some operators might also choose to enable this only when wanting to offer traceability to a PRC with QL mode as enhanced capability to a basic Synchronous Ethernet frequency reference service.

Additional Interface Limits at the UNI for Jitter and Wander are included in Section 13.3 when Synchronous Ethernet is used for Synchronous Service.

11.5 UNI Token Share

MEF 10.3 describes a new token sharing bandwidth profile algorithm that would be beneficial to an application like MBH in a multi-CoS deployment. With this algorithm, any of the CIR or EIR not consumed by the higher priority traffic class could be made available to lower traffic classes through a cascading of excess tokens. In addition, this mechanism could be used to load share across two EVCs used for resiliency.

[D5] The Mobile Backhaul Service **SHOULD** support a value of Enabled for the Token Share Service Attribute.

[CD1] < [D5] The Mobile Backhaul Service **SHOULD** support a model of a single EVC as the envelope and four CoS Names as the Bandwidth Profile Flows.

MEF 6.2 has requirement R2 and recommendation D1 for support of two or more Bandwidth Profile Flows when Token Share is Enabled. This IA is recommending four.

[CD2] < [D5] The Mobile Backhaul Service **SHOULD** support four Bandwidth Profile Flows based on CoS Names in 1 Envelope.

[CO1] < [D5] The Mobile Backhaul Service **SHOULD** support $CF^0 = 1$ in the Parameters for Bandwidth Profile.

11.6 UNI Service Attributes

MEF 6.2[3] identifies the parameter values for Service Attributes of each service defined in that specification – E-Line, E-LAN, and E-Tree. The following table lists the UNI attributes with values from MEF 6.2[3] and additional constraints, if any, as specified in this IA. Recommendations in the tables below are indicated in **bold**.

11.6.1 VLAN based MEF 6.2 Services

Per UNI Service Attribute	MEF 6.2 [3] EVPL	MEF 6.2 [3] EVP-LAN	MEF 6.2 [3] EVP-Tree	This IA (EVPL/EVP-LAN/EVP-Tree)
UNI Identifier	Arbitrary text string to identify the UNI			No additional constraints
Physical Layer	List of Physical Layers as specified in Section 9.2 of MEF 10.3 [7]			No additional constraints
Synchronous Mode	Disabled or Enabled for each link in the UNI			Section 11.4 [R19] UNI PHY in Synchronous mode Default MUST be Disabled
Number of Links	MUST be ≥ 1			No additional constraints
UNI Resiliency	None or 2-Link Aggregation or other			Section 10.3 [D4] SHOULD use 2-Link Aggregation
Service Frame Format	IEEE Std. 802.3-2012 [33]			No additional constraints
UNI Maximum Service Frame Size	MUST be ≥ 1522			See Section 12.5 for EVC attributes.
Service Multiplexing	Enabled or Disabled			Section 10.1 – see [R14]
CE-VLAN ID for untagged / priority tagged	MUST specify in the range of 1-4094.			No additional constraints
CE-VLAN ID / EVC Map	At least 1 CE-VLAN ID maps to the EVC			No additional constraints
Maximum number of EVCs	Maximum MUST be ≥ 1			Section 11.1: Minimum # of EVCs specified by - RAN BS UNI: See [R14], [R14] and [O6] - RAN NC UNI: See [R15] Minimum CE-VLAN IDs: No additional constraints.
Bundling	Enabled or Disabled.			No additional constraints
All to One Bundling	Disabled since VLAN based			No additional constraints
Token share	Enabled or Disabled			Section 10.5 [D5] SHOULD be Enabled
Envelopes	list of <Envelope ID, CF ⁰ , n>			Section 10.5 if Token Share Enabled
I-BWP per UNI	No			No additional constraints
E-BWP per UNI	No			No additional constraints
Link OAM	Enabled or Disabled			Section 8.1 [O2] MAY be Enabled
UNI MEG	Enabled or Disabled			Section 8.2 [R4] Additional constraints if Enabled

Per UNI Service Attribute	MEF 6.2 [3] EVPL	MEF 6.2 [3] EVP-LAN	MEF 6.2 [3] EVP-Tree	This IA (EVPL/EVP-LAN/EVP-Tree)
E-LMI	Enabled or Disabled			No additional constraints
UNI L2CP Address Set	CTA			See [R16] of MEF 45 Section 11.4.2 - ESMC processing
UNI L2CP Peering	<i>None or list</i>			No additional constraints

Table 6: Per UNI Service Attributes for VLAN based MEF 6.2 [3] Services

11.6.2 Port based MEF 6.2 Services

Cells in Table 7 have been highlighted if MEF 6.2 [3] service attributes have different requirements than for VLAN based Services.

Per UNI Service Attributes	MEF 6.2 [3] EPL	MEF 6.2 [3] EP-L AN	MEF 6.2 [3] EP-Tree	This IA (EPL/EP-LAN/EP-Tree)
UNI Identifier	Arbitrary text string to identify the UNI			No additional constraints
Physical Layer	List of Physical Layers as specified in Section 9.2 of MEF 10.3 [7]			No additional constraints
Synchronous Mode	Disabled or Enabled for each link in the UNI			Section 11.4 [R19] UNI PHY in Synchronous mode Default MUST be Disabled
Number of Links	MUST be ≥ 1			No additional constraints
UNI Resiliency	None or 2-Link Aggregation or other			Section 10.3 [D4] SHOULD use 2-Link Aggregation
Service Frame Format	IEEE Std. 802.3-2012 [33]			No additional constraints
UNI Maximum Service Frame Size	MUST be ≥ 1522			See Section 12.5 for EVC attributes.
Service Multiplexing	Disabled			No additional constraints
CE-VLAN ID for untagged / priority tagged	All untagged and priority tagged Service Frames at the UNI MUST map to the same EVC as is used for all other Service Frames.			No additional constraints
CE-VLAN ID / EVC Map	At least 1 CE-VLAN ID maps to the EVC			No additional constraints
Maximum	Maximum MUST be = 1			No additional constraints. See [R31] in Section

Per UNI Service Attributes	MEF 6.2 [3] EPL	MEF 6.2 [3] EP-L AN	MEF 6.2 [3] EP-Tree	This IA (EPL/EP-LAN/EP-Tree)
number of EVCs				12.4.1: at least 2 CoS Names,
Bundling	Disabled			No additional constraints
All to One Bundling	Enabled			No additional constraints
Token share	Enabled or Disabled			Section 10.5 [D5] MAY be Enabled
Envelopes	list of <Envelope ID, CF ⁰ , n>			Section 10.5 if Token Share Enabled
I-BWP per UNI	No			No additional constraints
E-BWP per UNI	No			No additional constraints
Link OAM	Enabled or Disabled			Section 8.1 [O2] MAY be Enabled
UNI MEG	Enabled or Disabled			Section 8.2 [R4] Additional constraints if Enabled
E-LMI	Enabled or Disabled			No additional constraints
UNI L2CP Address Set	<i>CTB</i>			See [R24] of MEF 45 Section 11.4.2 - ESMC processing
UNI L2CP Peering	<i>None or list</i>			No additional constraints

Table 7: Per UNI Service Attributes for Port based MEF 6.2 [3] Services

12. EVC Requirements

This section specifies requirements for EVC including service attributes and performance metrics for CoS Names, in addition to providing a recommended approach to supporting various traffic classes in the Mobile Backhaul service. The Mobile Operator might require different performance metrics for each of the CoS Names. Each CoS Name across a certain performance tier (MEF 23.1 [20]), identified by a CoS ID, can have an SLS specified for the set *S* of ordered UNI pairs with UNIs in the EVC. The EVC performance per CoS Name is one of the EVC attributes defined in MEF 6.2 [3], and MEF 10.3 [7]. The EVC requirements might not be uniform for all EVCs in the Mobile Backhaul.

In Section 8.2, [R2] requires compliance to the EVC attributes for the services defined in MEF 6.2 [3]. The EVC related attributes as specified in MEF 6.2 for VLAN and Port based services are listed in Section 12.5.

12.1 Maximum Number of UNIs

The Mobile Operator might have few hundred to thousand or more RAN BS sites in a given metro or region. Some traffic classes, such as management, control, packet method for synchronization, video multicast or broadcast, etc., might require a multipoint service and the service might be to some or all UNIs within that metro or region. For example, assuming that each RAN BS UNI in the EVC is configured for a CIR of 100Mb/s, one 10 Gigabit Ethernet port at RAN NC can support 100 UNIs (assuming no over subscription).

[D6] A multipoint Mobile Backhaul service **SHOULD** support Maximum number of UNIs in the EVC to be ≥ 100 .

A Mobile Operator can use less or more number of UNIs in the EVC. However, a CEN Operator is required to have this minimum capability.

12.2 EVC Maximum Service Frame Size

MEF 6.2 [3] requires a minimum of 1522 bytes for the EVC Maximum Service Frame Size. In the case of a Mobile Backhaul service for LTE a RAN BS can include additional encapsulation headers for user and control traffic classes as indicated in the protocol stacks discussed in 3GPP TS 36.300 [85]. In addition there might be variations depending on IP version as well as use of IPsec or header compression. In some deployments support for larger frames size might be necessary. For example, in LTE, with a user traffic payload size of 1500 bytes and headers for GTP (20 bytes), IPv6 (40 bytes) and IEEE Std. 802.1Q Ethernet (22 bytes), the frame size can be 1582 bytes. However, recognizing the issues that may be introduced with larger MTU sizes in backhaul for LTE, Annex C of 3GPP TS 23.060 [69] has suggested options to limit the user traffic payload size to a maximum of 1358 bytes for most network deployments.

This IA is not specifying a higher minimum value for the EVC Maximum Service Frame Size given the various options for headers. However, this IA is alerting the Mobile and CEN Operators to consider the encapsulation overhead when deciding a suitable EVC Maximum Service Frame Size.

When E-Line is used for Mobile Backhaul service then MEF 6.2 (Table 9 and Table 12) recommends having both ordered UNI pairs in set *S*. In some use cases the performance metrics might be different for the two ordered pairs. In such cases it is preferable to have separate set for each ordered pair. Hence, this IA is only recommending that both ordered pairs for an E-Line service be in the same set.

[O9] If E-LAN or E-Tree is used for Mobile Backhaul service then a set *S* **MAY** have subset of ordered UNI pairs.

For example, as discussed in Section 8.2, a E-LAN service could support connectivity between RAN BSs only or include RAN NC sites. In this case there can be different performance considerations for the subset that includes only UNIs at RAN BS sites, e.g. for X2 in LTE, in

contrast to the subset that includes RAN NC site, e.g. for S1 in LTE. These are different CoS Frame Sets. In addition these subsets can also be across different performance tiers (PT), i.e., X2 across a PT1 (metro) while S1 is across a PT2 (regional) as described in MEF 23.1 [20].

[O10] If E-LAN or E-Tree is used for Mobile Backhaul service then set *S* **MAY** contain all ordered UNI pairs.

12.3 EVC Performance

MEF 6.2 [3] specifies EVC Performance for metrics specified in Section 8.8 of MEF 10.3 [7], . Also, per MEF 23.1 [20], SLS has to be specified for a CoS Name identified by the tuple {S, CoS ID, PT}. While an SLS includes the metrics and parameters for each CoS Name it is possible to have some of these metrics as Not Specified (N/S) in the SLS. MEF 6.2 [3] recommends offering an SLS with at least one metric.

The Mobile Operator (Subscriber) uses the Availability objective to understand the long term (e.g. $T=1$ month) performance but uses counts \hat{L} (for HLI) and \hat{B} (for CHLI) metrics to understand the type of short term disruptions during the interval T .

Specifying an objective for the Availability, as well as the Group Availability, attribute is customer and CoS Name specific and might be negotiated as part of the SLS. Also, future phases of MEF 23.1 [20] might specify CPOs for MEF CoS Labels that can be used by the Operators if MEF Standard CoS Labels are to be used. The NGMN Alliance specification [102] recommends Availability objective of 99.99% for the Backhaul excluding eNB and aGW failures.

The total number of HLIs and CHLIs allowed during a measurement period might also be negotiated as part of the SLS. CHLI is set with a parameter 'p' that defines the number of small time intervals that make up a CHLI. For example, a Mobile Operator can choose an objective of no more than 10 events of 2 or more CHLI and no more than 25 HLI events during a measurement time period of 1 month. So a CEN that reports, for example, 6 events of 3 CHLI, and 1 event of 5 CHLI is in compliance with the SLS since the total 23 HLI reported for the measurement time has also not exceeded the objective for HLI. Future phases of MEF 23.1 [20] might include these metrics and define the CPO for the MEF CoS Labels.

MEF 23.1 [20] requires either IFDV or FDR but not both. Also, MEF 23.1[20] requires either MFD or FD but not both. The Mobile Operator has the option to select the metrics depending on the traffic class, e.g., conversations such as voice vs streaming such as video. Thus, the EVC Performance attribute per CoS ID for some traffic class might be: {FLR, FD=N/S, FDR, MFD, IFDV=N/S, A, HLI, CHLI}, where FD, IFDV are not specified since MFD and FDR are specified in this example. Table 6 of MEF 6.2 [3] has a recommendation to specify at least one combination of delay and delay variation metrics. While additional delay oriented metrics may be used, using only {MFD, IFDV} does not indicate an upper bound for delay.

- [D7] EVC Performance **SHOULD** include one of {FD, FDR} or {FD, IFDV} or {MFD, FDR} when Delay and Delay Variation performance objectives are specified in the SLS.

12.3.1 Performance for Synchronization Traffic Class

Packet method can be used for frequency synchronization as discussed in Section 13.2. The CoS Name, in the Mobile Backhaul service supporting synchronization traffic class, might need to meet a delay objective, when compared to the minimum delay, during the time interval of interest. Section 12.4.1 has additional discussion clarifying that not all use cases of packet based synchronization traffic class require the same performance requirements.

The network limit requirement in terms of maximum permissible levels of packet delay variation of the packet timing signal have been defined in ITU-T Rec. G.8261.1 [40] (in clause 8.1.1 for an HRM-1 network) in terms of the Floor Packet Percent (FPP) metric. The FPP metric (see G.8260 [38]) provides a measure of the percentage of packets that, within pre-defined observation windows, have delay variation below a certain threshold (as compared to a fixed value, corresponding to the observed minimum delay of the packets).

The characteristics of packet slave clocks that tolerate this level of packet delay variation while providing acceptable synchronization performance to mobile base stations have been defined in ITU-T Rec. G.8263 [42]. Hence, it is recommended to use the FPP metric and of the network limit defined in ITU-T Rec. G.8261.1 [40] to characterize mobile backhaul networks when transporting packet-based synchronization traffic.

The Frame Delay Range (FDR) metric is another metric characterizing the packet delay variation of a network, defined in MEF 10.3 [7]. This FDR metric is similar to the Packet Delay Variation (PDV) metric defined in ITU-T Y.1541 [36] for IP packets and to the Frame Delay Variation (FDV) metric defined in ITU-T Y.1563 [37] for Ethernet frames. The relevant parameters in the FDR metric are the time interval T (e.g. 1 month), the Subset S of ordered UNI pairs of the EVC and Percentile P_r of the Frame population that meets the Frame Delay Range metric, \bar{d}_{TrS} . The FDR is the maximum across all the ordered UNI pairs in Set S . The minimum delay, determined during the time interval T , is used to determine the delay difference of Frames in the CoS Name. During each measurement interval (see MEF 35.1 [27]), a certain minimum number of Frames in this CoS Name will need to meet the FDR metric.

- [R29] If a CoS Name is used for synchronization traffic class (i.e., packet method as described in Section 13.2) then the EVC Performance **MUST** have FDR specified, i.e., not N/S, in the SLS for the CoS ID.

The mobile operator and service provider could agree on suitable parameter values and objective for FDR. FPP and FDR metrics have some similarities -- the performance objectives are based on the notion of the minimum delay (and maximum variation of the delay compared with this value).

The following aspects however have to be taken into account. FDR-based performance performance objectives are evaluated over a predefined Time Interval T (e.g. 1 month) while FPP based performance objectives do not explicitly specify the overall measurement period (this is left to the specific SLA). FPP-based performance objectives must be met over all time windows (i.e., 200s time windows, either sliding or non-overlapping) included in the overall measurement period. This implies that if FPP based requirements are met, FDR would also be met. The opposite would in general not be true.

Note: For specific types of deployments and packet slave clocks implementations, a limited number of window intervals with a percentage of packets inside the FPP fixed cluster range smaller than normally required by the network limit could potentially be allowed in some cases; under these circumstances, the packet slave clock could maintain acceptable performance by going in holdover, allowing the network to temporarily exceed the specified FPP limits. This is an area that requires further analysis.

Another potential adaptation of the FPP metric defined in ITU-T could be when variations of the minimum delay, also called “floor delay”, occur over time (especially over long measurement periods such as 1 month). For example, if during this long measurement period there is a rerouting, the minimum delay would suddenly and potentially significantly change and the testing procedure should restart to consider the new minimum delay. In practice, if the floor (minimum) delay changes suddenly, it can in general be detected by the clock. Therefore rather than declaring that a network is not suitable to deliver timing under these circumstances, it might be desirable to dynamically change the floor also in the measurement procedure. These considerations are currently for further study in ITU-T and go beyond the current definition of the FPP metric in ITU-T.

- [D8]** If a CoS Name is used for synchronization traffic class (i.e., packet method as described in Section 13.2) then the EVC Performance **SHOULD** have FPP specified, i.e., not N/S, in the SLS for the CoS ID. The network limits defined in Rec. ITU-T G.8261.1 [40] **SHOULD** be referenced as a basis for the SLS.

Another important performance metric for Mobile Backhaul service supporting synchronization traffic class is the service availability. As explained in Appendix D of MEF 10.3.1 [8], the one-way Availability performance metric specified in Section 8.8.4 of MEF 10.3 [7] is not adequate to address Mobile Backhaul service supporting synchronization traffic class since it does not include inter-frame delay variation and frame delay performance. The Composite Performance Metric (CPM) defined in MEF 10.3.1 [8] is a similar metric, that can be used to complement the FDR and FPP metrics, while it is aimed at addressing synchronization or other traffic classes. Mobile Operators can include CPM in the SLS for mobile backhaul services with the Packet synchronization traffic class. Therefore, it is desired for Mobile Backhaul service supporting synchronization traffic class to support the CPM.

- [D9]** A Mobile Backhaul Service using EPL or EVPL for synchronization traffic (i.e., packet method described in Section 13.2) class **SHOULD** support Composite Performance Metric (MEF 10.3.1 [8]) in EVC Performance attribute

An example of the CPM parameter values to use are presented in Table B of Appendix D in MEF 10.3.1 [8].

12.3.2 Performance with RAN Resiliency

Mobile Operator can choose a Mobile Backhaul service with 2 or more diverse sets of ordered UNI pairs across the CEN Operator that might be individually resilient to failure. The diverse sets might be from a single EVC (e.g., E-LAN or E-Tree) or might be from 2 or more EVCs. The diverse sets are as discussed in Section 10.2.1 with the Mobile Operator identifying the sets that do not share the same risk of faults across the CEN including, optionally, at the UNI. The CEN Operator offers the SLS for each set and includes performance attributes such as Availability, HLI and CHLI as discussed in Section 12.3. In addition, the SLS can include the resiliency performance for the group of diverse sets.

Figure 30 shows one example where different UNIs serve different BS sites with EVC per BS site and having full diversity. The ESRG attribute is now used by the CEN Operator to assign resources with diverse facility SRG in the CEN. In this case, the Mobile Operator is using RAN Resiliency to improve its Radio Resiliency performance.

The Mobile Operator can also choose to have both UNIs serve the same RAN BS site but instead only require the sets to that BS site be fully or partially diverse. Of course, the Mobile Operator could purchase EVCs from different CEN Operators as well.

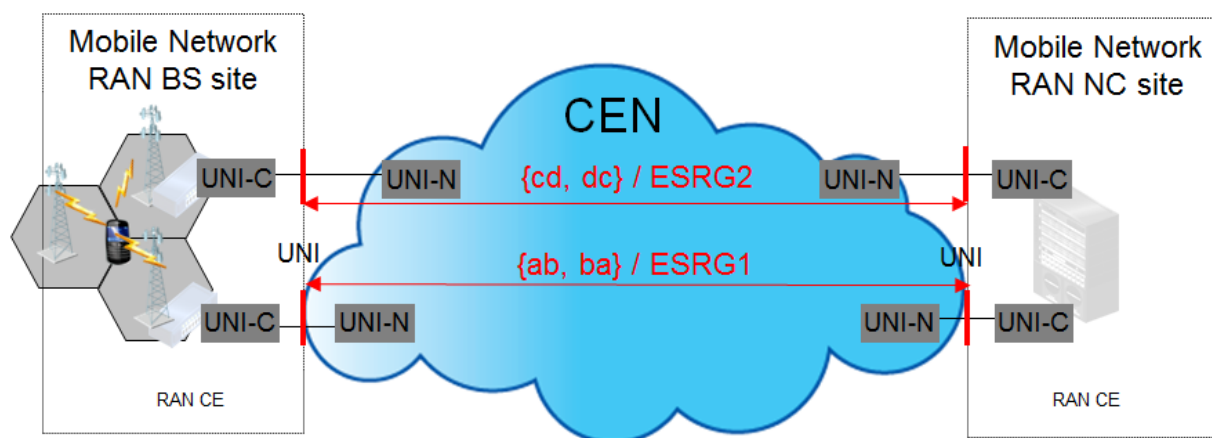

Figure 30: RAN based Resiliency using diverse EVCs and optionally diverse UNIs.

- [D10] A CEN Operator **SHOULD** support the capability to offer fully diverse sets of ordered UNI pairs with conformance to [R12].
- [D11] A CEN Operator **SHOULD** support the capability to offer partially diverse sets of ordered UNI pairs with conformance to [O5].

If partial diversity is sufficient then the Mobile Operator can negotiate with the CEN Operator, as part of the SLS, on the facility SRGs where the sets might not be diverse. For example, the sets

might have common UNI at a RAN BS site but can be diverse at RAN NC sites as shown in Figure 31.

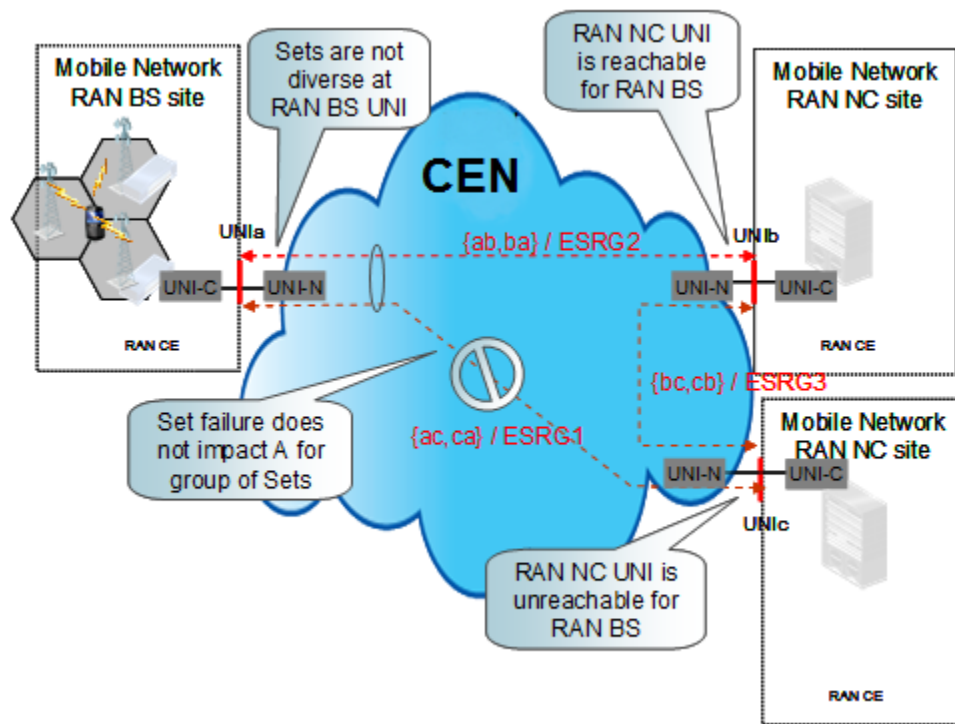

Figure 31: Partial diversity with common UNI at RAN BS site

Group availability is defined in MEF 10.3. As a result, if the SLS for the Mobile Backhaul service includes objective (i.e., it is not N/S) for Availability A_T metric in the interval T , for a group of diverse sets, then each of the sets in the group $\{S_k | k=1, 2, \dots\}$ is defined as in Section 10.2.1 and the metric A_T^S is specified with an objective (i.e., it is not N/S) for each of the sets in the group $\{S_k | k=1, 2, \dots\}$. Availability A_T may be determined as specified in Section 10.2.2.

Additionally, UNI Resiliency requirements such as in Section 11.3 can also apply.

12.4 Class of Service for Mobile Backhaul

Mobile standards defined by 3GPP, 3GPP2, and IEEE Std. 802.16 do not define requirements for the number of service classes that must be available in an Ethernet or IP based Mobile Backhaul network, but do identify user traffic classes on the radio interface. Appendix B is an informative appendix that examines user traffic classes defined by some mobile standards. Traffic classes defined for various mobile standards include these user traffic classes and additional traffic classes for management, synchronization, control, and signaling traffic types between RAN BSs and RAN NCs.

[R30] A Mobile Backhaul Service MUST meet the mandatory requirements of MEF 23.1 [20].

12.4.1 CoS Names

Mobile standards such as in 3GPP for LTE define traffic classes with a composite QCI for forwarding treatment and service performance – See Table 18 in Appendix B of this IA- that apply from the User's equipment to a Policy and Charging Enforcement Function (PCEF) at a RAN NC or gateway site (3GPP 23.203 [71]). The Mobile Operator might need a certain number of CoS Names, identified by a CoS ID (MEF 10.3 [7]) across a CEN to support the traffic classes between the RAN CEs. A CEN might be capable of supporting a certain number of CoS Names. If this is less than the number of traffic classes required by the Mobile Backhaul application it is possible for the Mobile Operator to aggregate traffic classes requiring similar service performance in to lesser number of CoS Names. The CoS ID for the CoS Name can be defined with more than 1 PCP or DSCP (MEF 10.3 [7]) which allows multiple traffic classes to get the same forwarding treatment in the CEN. The NGMN Alliance specification [102] includes recommendations to support at least 4 CoS Names per S1 interface per eNB (RAN BS site).

Table 8 provides an example mapping for Mobile Backhaul traffic classes into 3 and 2 MEF standard CoS Names consistent with MEF 23.1 [20], i.e., CoS Labels H/M/L, or 4 CoS Names with an additional H⁺ CoS Name as defined in this IA. CoS Labels (i.e., H, M, L) are the names for the CoS for which CoS ID and Color ID types and values, Bandwidth Profile constraints, CPO values and parameter values are specified (MEF 23.1 [20]). The H⁺ CoS Name, defined in this IA, might have more stringent performance objectives and parameters for FDR, IFDV, and A (MEF 10.3 [7]) compared to H CoS Label. The forwarding treatment for H⁺ is of higher priority than H.

CoS Names	Generic Traffic Classes mapping to CoS Names			
	4 CoS Names	3 CoS Names	2 CoS Names	2 CoS Names
Very High (H⁺) Defined in this IA	Synchronization	-	-	-
High (H) Defined in [20]	Conversational, Signaling, Network Management and Control	Synchronization, Conversational, Signaling, Network Management and Control	Synchronization, Conversational, Signaling, Network Management Control, and Streaming media	Synchronization, Conversational, Signaling, Network Management, Control, and Streaming media
Medium (M) Defined in [20]	Streaming media	Streaming media	-	Interactive and Background
Low (L) Defined in [20]	Interactive and Background	Interactive and Background	Interactive and Background	

Table 8: Examples of MBH Traffic Classes mapping to CoS Names in CEN

The names of the traffic classes used in Table 8 are meant to represent a non-exhaustive set of generic traffic classes that could apply across the mobile standards referenced in this IA. Only those Mobile Backhaul traffic classes that are applicable to the transport portion of a Mobile Backhaul solution are reflected in Table 8.

[D12] The mapping for supporting the entire set of traffic classes (user traffic, packet-based timing, control and signaling) used generally for Mobile Backhaul **SHOULD** be based on the mapping of Generic Traffic Classes to CoS Names defined in Table 8.

A Mobile Operator can have all traffic classes including management and signaling in different CoS Names of an EVC. For example, in an LTE use case with 4 CoS Names, identified as H⁺/H/M/L, at the EIs of the CEN, the control and signaling traffic for S1 can use the H CoS Label while the user traffic in S1 can use the H, M and L CoS Label. The Synchronization traffic class, from a packet based method, is using H⁺ CoS Name in this example. Further, if a separate CoS Name is needed for RAN BS management and if a CEN Operator is able to support more CoS Names in the CEN then the CoS IDs could be mutually agreed to.

A Mobile Operator could also use multiple EVCs, with each EVC providing the CoS ID for a separate CoS Name for different traffic classes including RAN BS management. The RAN BS needs the ability to classify the different traffic classes to different sets of CE-VLANs with EVC based CoS ID. CEN can then map the traffic to different EVCs at the UNI with the CE-VLAN to EVC map. Different EVCs might also be appropriate if each traffic class requires different

ingress bandwidth profile but are mapped to same CoS Name, e.g. M identified by PCP 3, since CoS IDs (e.g. EVC + PCP) need to be unique.

[R31] A Mobile Backhaul service **MUST** support at least 2 CoS Names at UNI.

MEF 23.1 [20] specifies three CoS Names, however it allows for additional CoS Names but does not address their CoS ID or CPOs. At a MEF compliant UNI the CoS ID mechanism (e.g., EVC or EVC+PCP or EVC+DSCP) used to indicate the priority for H⁺ CoS Name can be mutually agreed to by the Mobile Operator and CEN Operator when both MEF standard CoS Labels and other CoS Names are used at the UNI. The mapping of QCI to PCP/DSCP at the UNI-C on a RAN BS is not constrained by this IA.

MEF 6.2[3] recommends using EVC as the mechanism for Class of Service Identifier when one CoS Name. This IA also recommends EVC+PCP as another option

[D13] The CoS ID mechanism for a Mobile Backhaul service **SHOULD** be based on EVC or EVC+PCP.

[O11] The CoS ID mechanism for a Mobile Backhaul service **MAY** be based on EVC+DSCP.

MEF 10.3 includes IPv6 support when DSCP is used as the CoS ID mechanism. In certain cases, a Mobile Operator could benefit from IPv6 support for CoS ID.

[D14] For a VLAN based Mobile Backhaul Service the CEN **SHOULD** set CE-VLAN CoS Preservation service attribute to Yes to support NGMN Alliance Requirement R6 in [102].

The CE-VLAN CoS Preservation service attribute is set to Yes per MEF 6.2[3], for a Port based Mobile Backhaul Service.

It is important to note that at a MEF compliant UNI, when DSCP is used for the CoS ID (MEF 10.3 [7]) to identify the CoS Name to which untagged or tagged Service Frames are mapped to, the DSCP value is preserved by default.

Per [CR2] of MEF 6.2, when CoS ID includes PCP or DSCP priority markings at the UNI for a CoS Label, the CoS ID mechanism and values are specified in Table 4 of MEF 23.1 [20]

As stated in MEF 23.1 [20] a CoS ID of EVC (i.e., all possible PCP values) is allowed to be mapped to one CoS Label at the UNI in addition to other possible options such as EVC+PCP and EVC+DSCP.

When CoS ID is based on EVC then Color ID can be with the PCP values as specified in Table 3 of MEF 23.1 [20]. When CoS ID is based on EVC+PCP or EVC+DSCP then Color ID is as specified in Table 4 of MEF 23.1 [20]. Color ID for CoS Names not specified in MEF 23.1 [20] can be mutually agreed by Mobile and CEN Operators.

This IA does not preclude using color aware Ingress bandwidth profile for the CoS Name at the UNI. When a CEN Operator supports color aware bandwidth profile then a Mobile Operator can set frames in a CoS Name to be either discard ineligible (green) or discard eligible (yellow). Table 5 of MEF 6.2 has additional clarifications for Color Identifier based on requirements in MEF 10.3.

If color aware Ingress bandwidth profile is used for a CoS Label at the UNI then Color ID mechanism and value are specified in MEF 23.1 [R3] [20].

This IA supports token sharing between the MBH classes, but not with with other traffic classes that might be in the service. The forwarding treatment for H⁺, which would be used for only the synchronization traffic class, is of higher priority than H and would have CIR>0 (non-zero) CBS>0 to ensure sufficient green frames.

[R32] When token sharing is used across multiple CoS within an EVC, a Mobile Backhaul Ethernet Service with CoS Name H⁺ **MUST** have this traffic class as the highest priority flow in the Envelope.

[D15] A CEN **SHOULD** support H and L as specified in MEF 23.1 [20] when at least two CoS Labels are needed per UNI as shown in Table 8 of this IA.

[O12] A CEN **MAY** support H and M as specified in MEF 23.1 when at least two CoS Labels, are needed per UNI as shown in Table 8 of this IA.

A Mobile Operator can benefit by having a Mobile Backhaul service with more than 1 CoS Name. In particular, it is recommended that traffic classes such as background or interactive use CoS Label L especially when there is no need for the performance objectives of a CoS Label H or M. It is preferable if the traffic classes are mapped to at least 3 CoS Names with different performance metrics so as to efficiently use the Mobile Backhaul service. Furthermore, it is important to recognize that the H or H⁺ CoS Name will typically be used for traffic classes with small bursts in contrast to a M or L CoS Name. A Mobile Operator needs to take this in to consideration when choosing the CoS Name for a given traffic class, i.e., conversational class vs interactive or background.

[D16] A CEN **SHOULD** support H, M and L as specified in MEF 23.1 [20] when at least three CoS Labels are needed per UNI as shown in Table 8 of this IA.

One issue that could influence the suitable number of Mobile Backhaul CoS Names is the presence of some traffic classes, such as packet-based synchronization traffic. For example, if the RAN BS oscillator is stable and of high-quality then performance requirements for the CoS Name can be less stringent compared to when using a lower quality oscillator. A set of CoS Names, such as one limited to the CoS Labels (H,M,L) and associated CPOs, is most clearly applicable if synchronization is achieved either using a non-packet based method (such as GPS, SyncE, or TDM); or using a packet based method augmented by a stable high quality oscillator at the RAN BS.

It is a prerequisite that the performance requirements for a CoS Name depends on the most stringent traffic class. For example, if synchronization traffic class and voice traffic class share the same CoS Name then the performance requirements for the CoS Name are such that both traffic classes can be delivered while achieving the more stringent performance metrics of the two traffic classes.

If more stringent performance is required, this can be addressed in at least two ways: either having a single CoS Name for both synchronization traffic class and voice traffic classes or having a separate CoS Name with performance metrics suitable for the synchronization traffic class. In the former with single CoS Name the most stringent performance requirements would be derived from the synchronization traffic class and apply to voice traffic class as well. In the latter, with separate CoS Name for synchronization traffic, voice services are not affected by these stringent requirements but an additional CoS Name is required.

[D17] A CEN **SHOULD** have a dedicated CoS Name, H⁺, with higher forwarding priority and with performance as specified in Table 9 of this IA, for packet-based synchronization traffic class when requiring more stringent performance than the applicable SLS objectives based on CoS Label H specified in MEF 23.1 [20].

[D18] If more stringent objectives than the applicable SLS objectives based on CoS Label H specified in MEF 23.1 [20], are needed for delay and loss sensitive packet-based synchronization, then a CEN **SHOULD** support four CoS Names per UNI, including H⁺ as shown in Table 8 of this IA.

12.4.2 CoS Performance Objectives (CPO) for Backhaul

MEF services are defined with an SLS per CoS ID (MEF 6.2 [3]) where the SLS has performance metrics defined in MEF 10.3 [7], and this IA. Some performance metrics can be left as Not Specified (N/S) in the SLS. The Mobile Operator, as a customer of CEN, would benefit if the standard forwarding treatment of a CoS Name, identified by the triple {S, CoS ID, PT}, is known at the UNI along with the desired performance metrics for the Mobile Backhaul service. This performance per CoS Name is measured for the set of ordered UNI pairs in the CoS Name.

MEF 23.1 [20] has defined CoS Labels, and CPOs for the performance metrics of each CoS Label. The intent is to enable a CEN Operator to offer a standard menu of CoS Name options and also allow a CEN Operator to define CoS Names other than CoS Labels.

Performance metrics for the Ethernet service across CEN, derived from the parameters in mobility system standards, are generally included in the MEF CoS IA [20]. It is important to note that mobility system standards specify performance from a User's equipment to a PCEF in the core. This scope is larger than the scope of Mobile Backhaul (i.e., UNI to UNI) defined in this IA.

In 2G and 3G Mobile Networks the Mobile Backhaul has been mostly for the logical interface between the RAN BS and RAN NC within a metro type distance (e.g. <250km). Additionally, in these legacy networks, the RAN BS with legacy TDM interfaces might use a CES across the

CEN with additional delay due to the adaptation process of TDM frames into Ethernet frames. This can force additional constraints in performance across a CEN for delay and jitter.

With LTE or WiMAX, in addition to the S1 or R6 between a RAN BS and RAN NC, there is the X2 or R8 interface between RAN BS sites. The performance objectives for S1 or R6 can be significantly different from that for the X2 or R8. Some Mobile Operators can choose to have a centralized pool of S1/MME or ASN-GW servers and so the network topology might extend over a larger geographical distance (e.g. ~1000km). The X2 or R8, on the other hand, is between nearest neighbors (up to 32, for example) within a given access or metro type distance (e.g. ~250km).

The NGMN Alliance [102] has specified some attributes such as for Frame Delay and Availability but other performance attributes has been left for further study. A maximum one-way delay of 10ms (though it was erroneously published as two-way) has been specified in the NGMN Alliance specification [102]. 3GPP TS 22.278 [68] mentions (in Section 8) a maximum delay comparable to fixed access with a recommended target of <5ms (ideal conditions). 3GPP TS 25.913 [81] mentions (in Section 6.2.2) an objective of <5ms (unload condition) and for a single data stream having small IP packets with a zero length payload. These objectives are expected to be refined by 3GPP as the architecture gets updated and the different functional components of LTE are better defined.

This IA recommends use of the Performance Tier 1 (PT1) CPOs for CoS Label H, M and L as defined in MEF 23.1 [20]. The parameters for each performance objective are as defined in MEF 23.1 [20].

[D19] A MEF compliant Mobile Backhaul service **SHOULD** use PT1 as defined in MEF 23.1 [20].

[O13] A MEF compliant Mobile Backhaul service **MAY** use PT2 or PT3 as defined in MEF 23.1 [20].

[D20] A MEF compliant Mobile Backhaul service CoS Name, associated with a Point to Point EVC and based on CoS Label, **SHOULD** have SLSs that are bounded by the CPOs in Table 6 of MEF 23.1 [20] and with Parameters in Table 5 of MEF 23.1 [20].

Table 9 in this IA specifies the one way CPOs for Point-to-Point Mobile Backhaul service with 1 or more CoS Names: H, M, L and H⁺. This is based on stringent applications (including moderate radio coordination) or service requirements for Mobile Backhaul across all mobile technologies (2G to 4G) and thus will support any of the service (e.g. MEF 3, MEF 6.2) combinations across the same CEN. The table also contains an indication related to the bandwidth profiles (CIR and EIR) for each CoS Name. Less stringent values could be used for certain technologies, such as LTE or WiMAX, when supported alone or under certain mix of services/applications and network assumptions.

CoS Name	Ingress Bandwidth Profile(2)	One Way CPO for Mobile Backhaul Service {S, CoS ID, PT}									
		FD	MFD	IFDV	FDR	FLR	A	L	B	FPP	CPM
Very High (H ⁺)	CIR>0 EIR=0	≤ 10 ms	≤7 ms	N/S	A _{FDR}	≤.01 % (i.e., 10 ⁻⁴)	≥ A _{Avail}	≤ A _{HLI}	≤ A _{CHLI}	(3)	(4)
High (H)	CIR>0 EIR≥0	For CPO values across PT1 see Table 6 of MEF CoS IA [20].							(3)	(4)	
Medium (M)	CIR>0 EIR≥0	For CPO values across PT1 see Table 6 of MEF CoS IA [20].							N/S	N/S	
Low (L)	CIR≥0 EIR≥0(1)	For CPO values across PT1 see Table 6 of MEF CoS IA [20].							N/S	N/S	

Notes:

- (1) both CIR = 0 and EIR = 0 is not allowed as this results in no conformant Service Frames. CIR=0 and EIR>0 results in non-specified objectives.
- (2) Ingress Bandwidth Profile for CoS Labels (H, M and L) are from Table 2 of MEF 23.1[20].
- (3) FPP parameters from ITU-T G.8260 [38] need to be agreed between MO and CEN (as per [D8]). FPP is not specified for CoS Labels M and L in this phase of the IA.
- (4) CPM parameters are specified in Table B of MEF 10.3.1 [8]. CPM is not specified for CoS Labels M and L in this phase of the IA.
- A_{FDR} values and parameters for H⁺ to be included in a future phase of this IA. Values for FD and MFD might change depending on values for FDR.
- For Synchronization traffic class (see Section 12.3.1) A_{IFDV} for H⁺ = N/S since FDR is used. Also, either MFD or FD needs to be used in SLS.
- FLR value specified for H⁺ is the lowest, it could be smaller based on the SLA.
- CBS, EBS ≥ 8xMTU per MEF 13 [12]
- See Table 5 of MEF CoS IA [20] for Parameters and values for H, M and L

Table 9: One way CPOs across PT for Point-to-Point Mobile Backhaul service

[D21] A MEF compliant Mobile Backhaul service mapped as H⁺ CoS Name **SHOULD** use the values for the performance objectives and Bandwidth profile as specified in Table 9 of this IA.

Performance Attributes for which CPOs are not specified in MEF 23.1 [20] include Availability, HLI and CHLI.

12.4.3 CoS Performance Objectives (CPOs) for Small Cells With Tight Radio

Coordination

In 3G and 4G Mobile Networks the midhaul transport for small cell use case 3 (section 7.2.8) will be between the macro RAN BS and the small cell RAN BS within a relatively small distance

(e.g. resulting in EVCs of <10km). Across this midhaul interface there can be logical interfaces between the RAN BS sites (e.g., X2 for LTE) and/or it might contain a portion of logical interfaces for the RAN NC (e.g., S1) (per use cases 3a and 3b).

A macro-based mobile broadband network optimized for maximum performance, in capacity and coverage, will be complemented with small cells that for maximum performance may need to be tightly coordinated with the macro cells and potentially with other small cells. For maximum performance of radio features there are additional constraints that can be placed on the midhaul transport between the macro RAN BS and the small cell RAN BS. In such a case, assuming MEF services are used, those services may need to provide additionally constrained CoS performance objectives (CPOs) for small cells as shown in Figure 32:

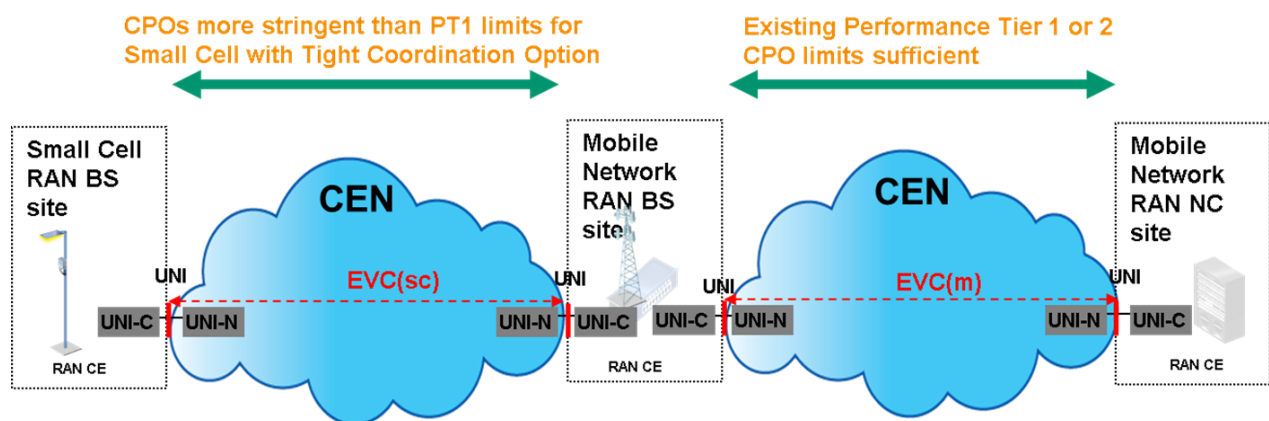

Figure 32: Two CPOs for Use Case 3

This IA recommends use of CPOs that are generally more stringent than the most stringent Performance Tier currently specified by MEF (PT1) as defined in MEF 23.1 [20]. These “tight-coordination” CPOs are used when tight radio coordination is implemented between the small cell and its neighboring cells, such as when certain LTE-Advanced features including Coordinated Multi-point (CoMP) are used.

[D22] A MEF compliant Mobile Backhaul with EVC(sc) for X2 or R8 that supports HetNet tight radio coordination **SHOULD** use the CPOs in Table 10 which are compliant with but more stringent than PT1 as defined in MEF 23.1 [12].

[O14] A MEF compliant Mobile Backhaul with EVC(sc) for X2 or R8 that supports HetNet moderate or no radio coordination service **MAY** use PT1 or PT2 [20].

For example, a small cell backhaul/midhaul use case with relaxed radio requirements and no radio coordination may use PT2 CoS Performance Objectives.

The existing requirements for macro backhaul will continue to apply for EVC (m). See 12.4.2.

Table 10 in this IA specifies the one way CPOs for Point-to-Point Mobile Backhaul service with 1 or more CoS Labels: H, M, L. This is based on tight radio coordination requirements for small cells for Mobile Backhaul across all mobile technologies (2G to 4G) and thus will support any of the service combinations (e.g., MEF 3, MEF 6.2) across the same CEN. It should be noted that mapping of radio coordination “signaling” to CoS labels is shown in Table 8.

CoS Name	Ingress Bandwidth Profile**	One Way CPO for Mobile Backhaul Service with Tight Radio Coordination – constrained PT1 {S, CoS ID, PT}							
		FD	MFD	IFDV	FDR	FLR	Availability	L	B
High (H)	$CIR > 0$ $EIR \geq 0$	≤ 1 ms	≤ 0.7 ms	≤ 0.3 ms	≤ 0.5 ms	See MEF 23.1 Table 6 PT1 [20]	TBD $\geq A_{Avail}$	TBD $\leq A_{HLI}$	TBD $\leq A_{CHLI}$
Medium (M)	$CIR > 0$ $EIR \geq 0$	≤ 2.9 ms	≤ 2 ms	≤ 0.9 ms or N/S	≤ 1 ms or N/S	See MEF 23.1 Table 6 PT1 [20]	TBD $\geq A_{Avail}$	TBD $\leq A_{HLI}$	TBD $\leq A_{CHLI}$
Low (L)	$CIR \geq 0$ $EIR \geq 0^*$	≤ 10 ms	≤ 8 ms	≤ 2.8 ms or N/S	≤ 2.9 ms or N/S	See MEF 23.1 Table 6 PT1 [20]	TBD $\geq A_{Avail}$	TBD $\leq A_{HLI}$	TBD $\leq A_{CHLI}$

Notes:

- (*) both $CIR = 0$ and $EIR = 0$ is not allowed as this results in no conformant Service Frames. $CIR = 0$ and $EIR > 0$ results in non-specified objectives.
- (**) Ingress Bandwidth Profile for CoS Labels (H, M and L) are from Table 2 of MEF 23.1[20].
- H+ is not further constrained by this Amendment, so is not shown. Impact of feature driven Time and Phase Synchronization is out of scope for this Amendment and is not included. In addition, no additional constraints are required for frequency synchronization.
- More stringent PT1 CPOs shown above may be utilized on a per CoS Name basis, e.g., radio default bearer on CoS Label L may not use tight radio coordination and thus may utilize PT1 CPOs rather than those shown for L above.
- CBS, EBS \geq MTU per MEF 23.1[20]

Table 10: One way CPOs for “tight radio coordination” for Point-to-Point Mobile Backhaul case when Synchronization is not provided on the Backhaul³

CPOs for “tight radio coordination” for Point-to-Point Mobile Backhaul case when time/phase synchronization is provided on the Backhaul are for a future deliverable in MBH Phase 3.

3GPP TR23.203 [21] suggests that the typical average delay⁴ for S1u traffic is 20ms. The constrained PT1 for small cells in the Figure 32 above allow for S1 traffic carried in a multi-CoS environment to be within reach of this average, and certainly within the 10ms to 50ms range. Figure 33 below shows the component contribution to the end-to-end latency as contributed to by node delays (assumed to be 1ms) and the constrained PT1 value of FD for EVC(sc) with CoS Name M (5ms) and the PT1 value of FD for EVC(m) with CoS Name M (20ms). This concatenation is shown as guidance so that operators can appropriately provision their backhaul networks. This figure does not imply any restriction on CoS levels on the EVC(sc) and EVC(m) segments (e.g., it could be CoS M in EVC(sc) and at CoS H at EVC(m)) to meet the 3GPP typical average delay.

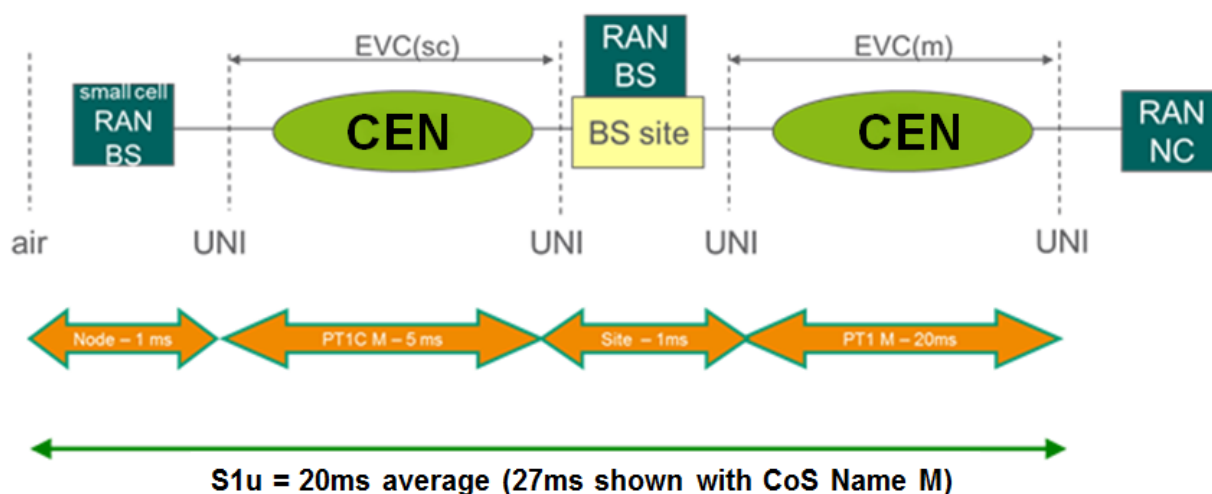

³ MEF 23.1 is being updated with the CoS Phase 3 project. This project will add a PT0.5 that is similar or equivalent to the constrained PT1 defined here. A future revision of MEF 22 will align with MEF 23.

⁴ The average delay of 20 ms is between a PCEF and a radio base station. It is the delay attributed to backhaul and should be subtracted from a given Packet Delay Budget (PDB) to derive the actual PDB that applies to the radio interface. The PDB defines an upper bound for the time that a packet may be delayed between the UE and the PCEF. The PDB shall be interpreted as a maximum delay with a confidence level of 98 percent.

Figure 33: S1u FD budget for small cell use case

12.4.4 CoS Performance Objectives (CPOs) for Small Cells With Split Bearer

3GPP TS 36.842 [22] introduces bearer splitting for LTE in support of dual connectivity. There are 3 main options described, but recommended option 3C highlights the midhaul architecture shown in in Figure 23. The small cell becomes a secondary eNB (SeNB) and is only connected to its master eNB (MeNB). This interconnection is an X2 interface (labeled Xn) carrying both user and control plane traffic, while supporting a slightly higher latency (see Appendix E). Dual connectivity without S1 is described in 3GPP 36.300[85]section 4.9. However, R12 describes only down link dual connectivity (thus S1 is still used for up link), dual connectivity support on the up link is under study for R13.

The midhaul transport required for small cell use case 3c (section 7.1.4) will be between the macro RAN BS and the small cell RAN BS within a relatively small distance (e.g. resulting in EVCs of <10km). However, this midhaul interface will only support the Xn logical interfaces between the RAN BS sites.

In such a case, assuming MEF services are used, those services need less constrained CoS performance objectives (CPOs) for small cells. That is, the CPO requirements in 11.5.2 would apply.

12.5 EVC per UNI and per EVC Service Attributes

MEF 6.2[3] identifies the parameter values for Service Attributes of each service defined in that specification. The following table lists the EVC attributes with values from MEF 6.2[3] and additional constraints, if any, as specified in this IA.

12.5.1 VLAN based MEF 6.2 Services

EVC per UNI Service Attributes	MEF 6.2 EVPL	MEF 6.2 EVP-LAN	MEF 6.2 EVP-Tree	This IA (EVPL/EVP-LAN/EVP-Tree)
UNI EVC ID	A string formed by the concatenation of the UNI ID and the EVC ID.			No additional constraints
Class of Service Identifier for Data Service Frame	EVC or CE-VLAN CoS or IP value(s) and corresponding CoS Name			Section 12.4.1 [D13] and [O11]
Class of Service Identifier for L2CP Service Frame	“All” or list of each L2CP in the EVC and corresponding CoS Name			No additional constraints
Class of Service Identifier for SOAM Service Frame	Basis same as for Data Service Frames			No additional constraints
Color Identifier for Service Frame	None or EVC or CE-VLAN CoS or CE-VLAN Tag DEI or IP			See 12.4.1 0
Egress Equivalence Class Identifier for Data Service Frames	CE-VLAN CoS or IP value(s) and corresponding Egress Equivalence Class			No additional constraints
Egress Equivalence Class Identifier for L2CP Service Frames	“All” or list of each L2CP in the EVC and corresponding Egress Equivalence Class			No additional constraints
Egress Equivalence Class Identifier for SOAM Service Frames	Basis same as for Data Service Frames			No additional constraints
Ingress Bandwidth Profile per EVC	No			No additional constraints
Egress Bandwidth Profile per EVC	No			No additional constraints
I-BWP per CoS ID	Enabled or Disabled			Section 12.4

EVC per UNI Service Attributes	MEF 6.2 EVPL	MEF 6.2 EVP-LAN	MEF 6.2 EVP-Tree	This IA (EVPL/EVP-LAN/EVP-Tree)
				See various requirements and CPO table for CoS ID and BWP
E-BWP per CoS ID	Enabled or Disabled			Section 12.4 Requirements for CoS ID
Source MAC Address Limit	Disabled Depends on service delivery attributes being unconditional	Enabled or Disabled		No additional constraints
Test MEG	Enabled or Disabled			No additional constraints
Subscriber MEG MIP	Enabled or Disabled			No additional constraints

Table 11: EVC per UNI Service Attributes for VLAN based MEF 6.2 [3] Services

Per EVC Service Attributes	MEF 6.2 EVPL	MEF 6.2 EVP-LAN	MEF 6.2 EVP-Tree	This IA (EVPL/EVP-LAN/EVP-Tree)
EVC Type	MUST be Point-to-Point	MUST be Multipoint-to-Multipoint	MUST be Rooted-Multipoint	No additional constraints
EVC ID	An arbitrary string, unique across the CEN, for the EVC supporting the service instance.			No additional constraints
UNI List	list of <UNI ID, UNI Role=Root> pairs		list of <UNI ID, UNI Role> pairs	No additional constraints
Max # of UNIs	2	≥ 3		Section 12.1 See [D6] for minimum if multipoint EVC
EVC Maximum Service Frame Size	MUST be ≥ 1522			No additional constraints See Section 12.2 for guidelines
CE-VLAN ID Preservation	Enabled or Disabled			No additional constraints
CE-VLAN CoS Preservation	Enabled or Disabled			Section 12.4.1 [D14] for VLAN based Services
Unicast Delivery	Discard or Deliver Unconditionally or Deliver Conditionally.			No additional constraints
Multicast Delivery	Discard or Deliver Unconditionally or Deliver Conditionally.			No additional constraints
Broadcast Delivery	Discard or Deliver Unconditionally or Deliver Conditionally.			No additional constraints
EVC Performance	A list of performance metrics and associated parameters and performance objectives			Section 12 Requirements on Set S, CoS Name, CoS ID and EVC Performance including CEN or RAN Resiliency

Table 12: Per EVC Service Attributes for VLAN based MEF 6.2 [3] Services

12.5.2 Port based MEF 6.2 Services

Cells in Table 13 and Table 14 have been highlighted if MEF 6.2 [3] service attributes have different requirements than for VLAN based Services.

EVC per UNI Service Attributes	MEF 6.2 EPL	MEF 6.2 EP-LAN	MEF 6.2 EP-Tree	This IA (EPL/EP-LAN/EP-Tree)
UNI EVC ID	A string formed by the concatenation of the UNI ID and the EVC ID.			No additional constraints

EVC per UNI Service Attributes	MEF 6.2 EPL	MEF 6.2 EP-LAN	MEF 6.2 EP-Tree	This IA (EPL/EP-LAN/EP-Tree)
Class of Service Identifier for Data Service Frame	EVC or CE-VLAN CoS or IP value(s) and corresponding CoS Name			No additional constraints
Class of Service Identifier for L2CP Service Frame	“All” or list of each L2CP in the EVC and corresponding CoS Name			No additional constraints
Class of Service Identifier for SOAM Service Frame	Basis same as for Data Service Frames			No additional constraints
Color Identifier for Service Frame	None or EVC or CE-VLAN CoS or CE-VLAN Tag DEI or IP			No additional constraints
Egress Equivalence Class Identifier for Data Service Frames	CE-VLAN CoS or IP value(s) and corresponding Egress Equivalence Class			No additional constraints
Egress Equivalence Class Identifier for L2CP Service Frames	“All” or list of each L2CP in the EVC and corresponding Egress Equivalence Class			No additional constraints
Egress Equivalence Class Identifier for SOAM Service Frames	Basis same as for Data Service Frames			No additional constraints
Ingress Bandwidth Profile per EVC	No			No additional constraints
Egress Bandwidth Profile per EVC	No			No additional constraints
I-BWP per CoS ID	Enabled or Disabled			Section 12.4 Requirements for CoS ID and BWP

EVC per UNI Service Attributes	MEF 6.2 EPL	MEF 6.2 EP-LAN	MEF 6.2 EP-Tree	This IA (EPL/EP-LAN/EP-Tree)
E-BWP per CoS ID	MUST be No	Enabled or Disabled		Section 12.4 Requirements for CoS ID
Source MAC Address Limit	Disabled	Enabled or Disabled		No additional constraints
Test MEG	Enabled or Disabled			No additional constraints
Subscriber MEG MIP	Enabled or Disabled			No additional constraints

Table 13 EVC per UNI Service Attributes for Port based MEF 6.2 [3] Services

Per EVC Service Attributes	MEF 6.2 EPL	MEF 6.2 EP-LAN	MEF 6.2 EP-Tree	This IA (EPL/EP-LAN/EP-Tree)
EVC Type	MUST be Point-to-Point	MUST be Multipoint-to-Multipoint	MUST be Rooted-Multipoint	No additional constraints
EVC ID	An arbitrary string, unique across the CEN, for the EVC supporting the service instance.			No additional constraints
UNI List	list of <UNI ID, UNI Role=Root> pairs		list of <UNI ID, UNI Role> pairs	No additional constraints
Max # of UNIs	2	≥ 3		Section 12.1 See [D6] for minimum if multipoint EVC
EVC Maximum Service Frame Size	MUST be ≥ 1522			No additional constraints See Section 12.2 for guidelines
CE-VLAN ID Preservation	Enabled			No additional constraints
CE-VLAN CoS Preservation	Enabled			Section 12.4.1 for Port based Services
Unicast /Multicast/ Broadcast Delivery	MUST Deliver Unconditionally.	Deliver Unconditionally or Deliver Conditionally. If Delivered Conditionally, MUST specify the delivery criteria.		No additional constraints
EVC Performance	A list of performance metrics and associated parameters and performance objectives			Section 12 - Requirements on Set S, CoS Name, CoS ID and EVC Performance including CEN or RAN Resiliency

Table 14 Per EVC Service Attributes for Port based MEF 6.2 [3] Services

13. Synchronization

Synchronization is a generic concept of distributing common time and frequency references to all nodes in a network to align their time and frequency scales. In this IA timing is used as a single term to refer to either time or frequency. Synchronization is a key component in mobile technologies and different mobile technologies have different synchronization requirements. This phase of the IA addresses frequency synchronization only. Time and phase synchronization are for a future revision of this IA.

Synchronization is used to support mobile application and system requirements to minimize radio interference, facilitate handover between base stations, and to fulfill regulatory requirements. Various mobile technologies stipulate that the radio signal must be generated in strict compliance with frequency, phase and time accuracy requirements, as illustrated in Table 15.

Technology	Frequency (ppb)	Phase (μ s)	Time (μ s)	Reference Document
CDMA	± 50		± 3 (Traceable & Synchronous to UTC)	TIA/EIA-95-B [63]
CDMA2000	± 50		± 10 (>8hrs) when external timing source disconnected ± 3 (Traceable & Synchronous to UTC)	3GPP2 C.S0002-E v2.0 [64] C.S0010-C v2.0 [66]
GSM	± 50 ± 100 (pico BS)			ETSI TS 145.010 [64]
UMTS-FDD (WCDMA)	± 50 (Wide area BS) ± 100 (Medium range BS) ± 100 (Local area BS) ± 250 (Home BS)	12.8 (MBSFN-3GPP Release 7/8)		3GPP Frequency: TS 25.104 [75] MBSFN: TS 25.346 [77]

Technology	Frequency (ppb)	Phase (μ s)	Time (μ s)	Reference Document
UMTS-TDD (WCDMA)	± 50 (Wide area) ± 100 (Local area) ± 250 (Home eNB)	± 2.5 ± 1 (between Macro eNB and Home eNB)		3GPP Frequency: TS 25.105 [76] Phase: TS 25.402 [78] Home eNB: TR 25.866 [80]
TD-SCDMA	± 50	± 3		3GPP TS 25.123[74]
LTE (FDD)	± 50 (Wide area) ± 100 (Local area) ± 250 (Home eNB)	CDMA handover and Synchronized E-UTRAN GPS time ± 10 (> 8hours) when external timing source disconnected		3GPP Frequency: TS 36.104 [83] Time: TS 36.133 [84]
LTE (TDD)	± 50	≤ 3 (small cell) ≤ 10 (large cell) CDMA handover and Synchronized E-UTRAN GPS time ± 10 (> 8hours) when external timing source disconnected		3GPP Frequency: TR36.922 [88] Phase & Time: TS36.133 [84]
Mobile WiMAX	± 2000 (i.e., 2ppm)	$\leq \pm 1$		IEEE Std. 802.16-2009 [34] WMF-T23-001-R015v01 [100]

Table 15: Mobile Technology Synchronization Requirements

There are four main methods related to timing distribution from a PRC, i.e., timing source, to slave clocks at a RAN BS site:

1. Using GPS at RAN BS sites
2. Using a legacy TDM network with a TDM demarcation to RAN BS;
3. Using a CEN with Ethernet physical layer (Synchronous Ethernet) for links.
4. Using a CEN with packet based methods and protocols such as PTP [35] or NTP [92], and ACR[98]/RTP [97].

At the RAN BS site, in case the Synchronous Ethernet is terminated by a co-located transport equipment, the timing can be delivered from this transport equipment to the Radio Base Station via any other suitable standard interface (e.g. 2048 KHz according to G.703 [48])

At the RAN BS site, in case the timing, carried by the packet based method, is recovered by a co-located equipment the physical interface that can be used to distribute the timing to the Radio Base Station can be Synchronous Ethernet or any other suitable standard interface (e.g. 2048 KHz according to G.703 [48]).

Some of the above methods can provide only frequency synchronization (e.g. Synchronous Ethernet, legacy TDM network, ACR/RTP). Method 1 and 2 are outside of the scope of this IA. Method 3 and 4 for frequency synchronization are examined in the scope of this IA. Method 4 using PTP has been defined in ITU-T for frequency synchronization but use for phase or time synchronization is yet to be specified. Method 4 for time and phase synchronization is out of scope for this revision of this IA.

Packet based methods are addressed in Sections 13.2. Synchronous Ethernet is addressed in Sections 13.3 and 11.4.

13.1 Performance of synchronization architecture

The performance of Synchronization distribution architecture of a SP is measured by compliance to jitter and wander limits, over certain time intervals, at the network interface offering the Synchronization service to a customer's equipment. Both the choice of architecture, the level of performance impairments (i.e., FDR) and whether the synchronization service is directly terminated at the 'End Equipment', i.e., RAN BS, impact the jitter and wander limits at the network interface. In the context of this document the 'End Equipment' is the single base station at RAN BS. Also, when the UNI-C is not on the RAN BS then the frequency reference is delivered to a 'Connected Equipment', which might be a GIWF or other equipment in the RAN BS site, owned by the Mobile Operator.

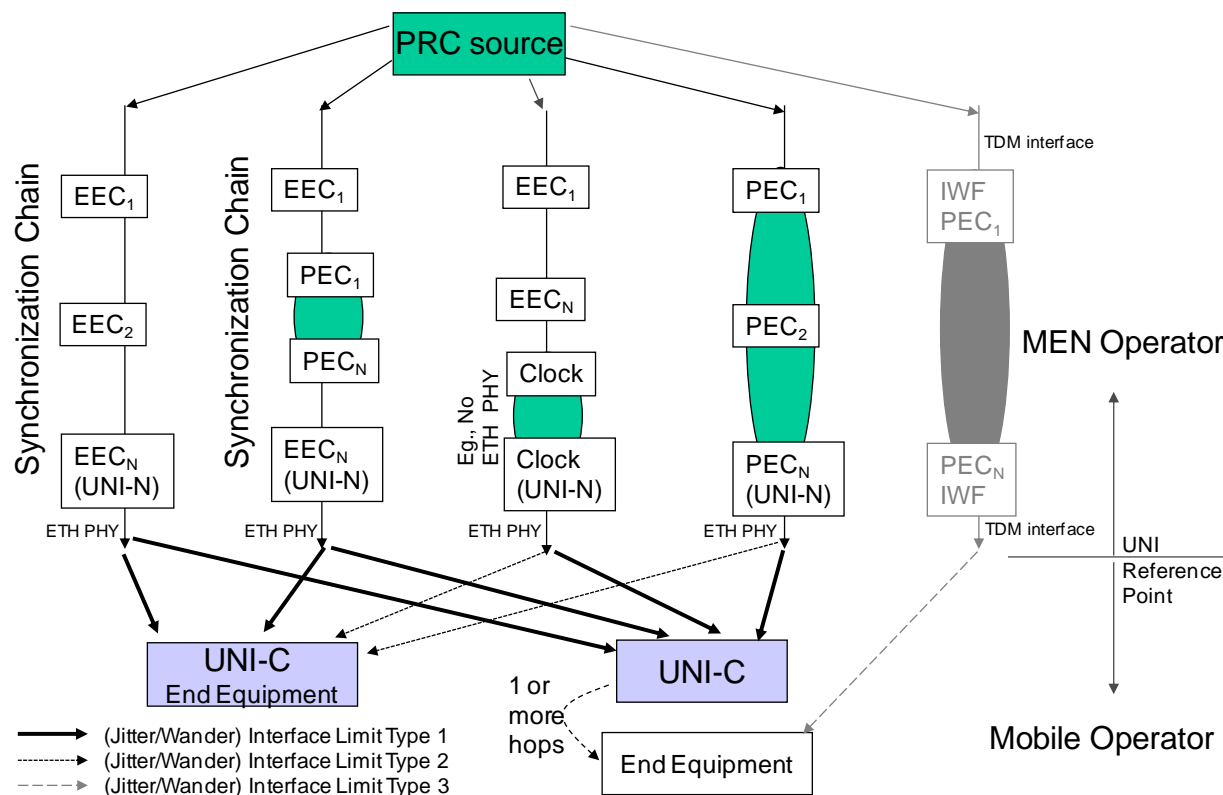

Figure 34: Synchronization Distribution Models from PRC source to RAN BS UNI

Figure 34 describes different scenarios in terms of synchronization distribution. The distribution chain can be entirely EECs or a mix of PECs and EECs or other clocks. This IA is not specifying the choice of the Synchronization architecture but is specifying interface limits for jitter and wander as follows:

1. Interface Limit Type 1: in this case, limits are described in Sections 13.2.1 and 13.3.1
2. Interface Limit Type 2: in this case limits are described in Sections 13.2.2 and 13.3.2;
3. Interface Limit Type 3: in this case limits are described in Section 13.2.3.

13.2 Packet Based Methods

A master-slave hierarchy, similar to model described for SDH in ITU-T G.803 [50], is used for packet based methods with Packet Equipment Clocks. The source clock is distributed from a Primary Reference Clock (PRC).

The focus of this IA is on frequency synchronization. For the UNI, there are two main use cases as shown in Figure 35:

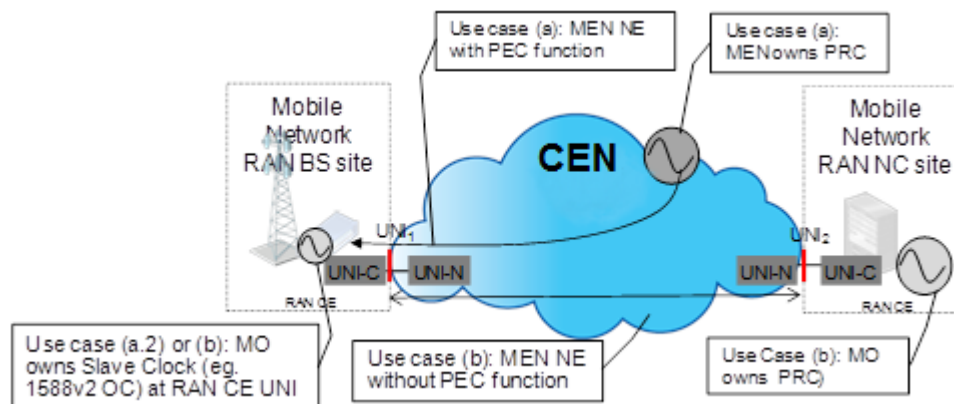

Figure 35: UNI use cases for packet method to distribute reference timing

- (a) CEN NE with PEC function: This functionality can be at the NEs with UNIs to RAN BSs or can also be present at other NEs within the CEN. Also, CEN provides the source clock (PRC) for the synchronization service. PEC in support of packet method (for non CES application) will be defined by ITU-T.
- (a.1.) Slave clock at the CEN's UNI: The timing (frequency) information can be directly recovered from the frame arrival times, e.g., ACR, such as when CES (MEF 3 [1]) is the backhaul service to RAN BS with TDM interfaces. PEC functions, as shown in Figure 34, are used to translate the frame arrival rate in to a physical layer frequency over the Interface. Performance at the network interface is specified in Sections 13.2.1 and 13.2.2 with Ethernet demarcation as well as Section 13.2.3 with TDM demarcation using GIWF.
 - (a.2.) Slave clock in RAN BS: The CEN's PEC function at the UNIs, or any NE in CEN, participates in the protocol to provide additional information such as accumulated delay. This use case is for further study in a future phase of this IA.
- (b) CEN NE without PEC function: Mobile Operator owns timing source at RAN NC site(s) and slave clocks at RAN BSs as defined in ITU-T G.8265 [45] and, in case of PTP, with a IEEE Std. 1588 PTP profile for frequency distribution as defined in ITU-T G.8265.1 [46]. The CEN provides EVC with performance objectives in support of the synchronization traffic class. See Section 8.2 for EVC Types and Section 12 for EVC, CoS as well as CPO for the CoS Name used to support packet based synchronization traffic class. The slave clock at RAN BSs can implement the PEC function to recover timing based on frame arrival rates or timestamps.

The UNI can be in Asynchronous Full Duplex Mode, i.e., Synchronous Ethernet mode of operation is disabled, when the CEN Operator is offering a Mobile Backhaul service to support the synchronization traffic class.

For the ENNI, there are also to main use cases as shown in Figure 37: Example of Synchronization Service using Synchronous Ethernet

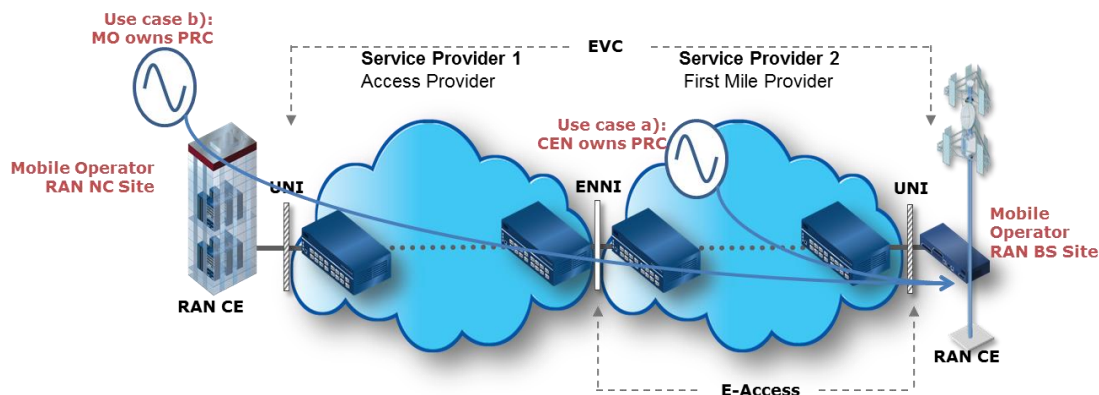

Figure 36 - ENNI use cases for packet method to distribute reference timing

- (a) CEN NE with PEC function: This functionality is the same as in the UNI case shown in Figure 35.
- (b) CEN NE without PEC function: As in the UNI case, the Mobile Operator owns timing source at RAN NC site(s) and slave clocks at RAN BSs as defined in ITU-T G.8265 [45] and, in case of PTP, with a IEEE Std. 1588 PTP profile for frequency distribution as defined in ITU-T G.8265.1 [46]. The CEN provides EVC with performance objectives in support of the synchronization traffic class. However, there is no guidance provided in this IA on how to distribute the performance objective budget of the EVC between the two CEN operators.

13.2.1 Network (UNI-N) Interface Limits for Packet based Methods

When a packet based synchronization service is provided to a UNI-C not on ‘End Equipment’ at RAN BS site, then Interface Limit Type 1 applies as shown in Figure 34. The requirement in terms of tolerance and level of accuracy for the recovered timing signal are as defined for deployment case 1 in ITU-T G.8261 (see clause 9.2.2.1) [39].

[R33] If UNI-C is not on ‘End Equipment’ at RAN BS site (i.e., RAN BS) then the Interface Limits for Jitter and Wander at the UNI-N **MUST** meet clause 9.2.2.1 EEC network limits as defined in ITU-T G.8261 for deployment case 1 [39]

13.2.2 Network (UNI-N) Interface Limits for Packet based Methods – Special Case

When a packet based synchronization service is provided to a UNI-C on ‘End Equipment’ at RAN BS site, then Interface Limit Type 2 applies as shown in Figure 34. The requirement in terms of tolerance and level of accuracy for the recovered timing signal are as defined for deployment case 2 in ITU-T G.8261 Recommendation (see clause 9.2.2.1) [39].

Typically, Base Stations are designed to tolerate wander as per G.823 / G.824 traffic masks of T1/E1 interfaces, Section 4.2.1 and Reference 16 in 3GPP TS 25.411 [74].

- [O15] If UNI-C is on ‘End Equipment’ at RAN BS site (i.e., RAN BS), as defined in deployment case 2 of ITU-T G.8261 (see clause 9.2.2.1) [39], then the Interface Limits for Jitter and Wander at the UNI-N **MAY** be as defined by ITU-T G.823 clause 5 [57] or ITU-T G.824 clause 5 [58]

It is important to note that the looser criteria might be justified as long as the tolerance of the ‘End Equipment’ at BS site is met.

13.2.3 Network (UNI-N) Interface Limits for Packet based Methods, use case b

When a packet based synchronization service is provided to a UNI-C without PEC function in the CEN NE, the requirement in terms of maximum permissible levels of packet delay variation of the packet timing signal are as defined in clause 8 of G.8261.1 [40].

13.2.4 CES timing requirements

Use case 1a and 1b in Section 8.1.1 has a SP delivering Mobile Backhaul service at a TDM demarcation using a GIWF with TDM interface to the RAN CEs. The internal implementation details of the GIWF are out of the scope for this IA.

13.2.4.1 Network (TDM Interface) Interface Limits at Output of GIWF

Interface Limit Type 3, as shown in Figure 34, applies for the synchronization performance at the TDM demarcation.

- [R34] The synchronization distribution **MUST** be such that jitter and wander measured at the output of the GIWF TDM interface meets the traffic interface requirements specified in ITU-T G.823 [57] for E1 and E3 circuits, and ITU-T G.824 [58] for DS1 and DS3 circuits and, in case of SDH signals, that meet the network limits for the maximum output jitter and wander at the relevant STM-N hierarchical interface as specified by ITU-T G.825 [59].

- [D23] The synchronization distribution **SHOULD** be such that the wander budget allocated to the CEN and the GIWF as measured at the output of the GIWF TDM interface meets the traffic interface requirements of ITU-T G.8261, Deployment Case 2 [39].

13.2.4.2 Network (TDM Interface) Interface Limits at Input of GIWF

- [R35] Jitter and wander that can be tolerated at the GIWF TDM input **MUST** meet the traffic interface requirements specified in ITU-T G.823 [57] for E1 and E3 circuits, and ITU-T G.824 [58] for DS1 and DS3 circuits and in case of SDH signals, the GIWF TDM **MUST** meet the jitter and wander tolerance for STM-N input ports as specified by ITU-T G.825 [59].

13.3 Synchronous Ethernet Methods

The IEEE Std. 802.3-2008 standard [33] specifies that transmit clocks can operate with a frequency accuracy of up to ± 100 ppm. The Synchronous Ethernet (SyncE) approach provides a mechanism to deliver a network traceable physical layer clock over IEEE Std. 802.3 PHYs with EEC as specified in ITU-T G.8262 [41]. The SyncE model follows the same approach as was adopted for traditional TDM (PDH/SDH) synchronization i.e., utilizing the physical layer line signals, and implemented with similar engineering rules and principles. Synchronous Ethernet has also been designed specifically to inter-work with the existing SONET/SDH synchronization infrastructure. Note that Synchronous Ethernet is used to deliver frequency, but not phase or time of day.

The architectural aspects of Synchronous Ethernet are defined in ITU-T G.8261 [39]. SyncE provides the capability to provide an Ethernet clock that is traceable to a primary reference clock (PRC) as defined in ITU-T G.811 [52]. The details of the clock aspects of Synchronous Ethernet equipment can be found in the ITU-T G.8262 [41]. The latter specification defines the requirements for clock accuracy, noise transfer, holdover performance, noise tolerance and noise generation.

The frequency reference, delivered to the UNI-C at RAN BS site, is traceable to the CEN (Service Provider) PRC, as shown in Figure 37 below. The Mobile Operator can specify the required performance in terms of Network Interface Limit for Jitter and Wander at the UNI-N.

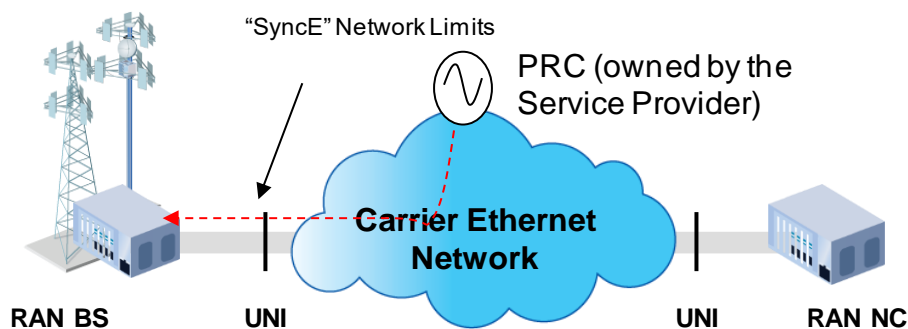

Figure 37: Example of Synchronization Service using Synchronous Ethernet

Further considerations on the use of Synchronous Ethernet in a multi-operator context can be found in ITU-T G.8264 Amendment 1 [43] for when Mobile Operator owns the PRC and CEN Operator is responsible for distribution of frequency reference to RAN BS sites.

13.3.1 Network (UNI-N) Interface Limits for Synchronous Ethernet Methods

When the Synchronization distribution across the CEN is a chain of EECs then Interface Limit Type 1 applies as shown in Figure 34. Two options are specified for Synchronous Ethernet equipment slave clocks (EECs). The first option, called EEC option 1, has been defined for networks using the 2048 kbps Synchronization hierarchy as defined in ITU-T G.813 option 1 for SDH networks [55][56]. The second option, called EEC option 2, applies to Synchronous Ethernet equipments that are designed to interwork with networks optimized for 1544 kbps synchronization hierarchy and has defined based on ITU-T G.813 option 2 [55][56] and G.812 Type IV [53][54].

[R36] At the output of the UNI-N at a RAN BS site, when Synchronous Ethernet service is provided to the UNI-C at RAN BS, the interface **MUST** meet clause 9.2.1 EEC network limits from ITU-T G.8261 [39]:

The interface limits in [R36] are defined assuming the CEN implements a Synchronous reference chain as described in clause 9.2.1 of ITU-T G.8261 [39]. Synchronization chains based on Synchronous Ethernet are according to ITU-T G.823 [57], ITU-T G.803 [50] and ITU-T G.824 [58] models. [R36] is also required when there are intermediate nodes between the UNI-N and the Base Station that are part of an EEC chain.

13.3.2 Network (UNI-N) Interface Limits - Special Cases

As mentioned in amendment 1 of clause 9.2.1 in ITU-T G.8261 [39] it is noted that the limits defined in ITU-T G.823 [57], ITU-T G.824 [58] and ITU-T G.825 [59] are generally applicable at all points in the Synchronization network. In some applications the CEN might not implement the Synchronization reference chain as described in clause 9.2.1 of ITU-T G.8261 [39]. These are defined as the limits for traffic carrying signals as opposed to synchronization signals. In some cases, a SP might decide that these less stringent limits are more appropriate for their network due to the types of links and equipment in the reference chain. Often these limits are used in conjunction with CES implementations.

In access networks, it might be possible to recover frequency reference from an Ethernet signal that is generating jitter and wander according to the tolerance characteristics of the ‘Connected Equipment’. Across the CEN either there is no chain of EECs/SECs/ or it is a Synchronization distribution network where timing is not carried on every link by an Ethernet PHY. The frequency reference is, however, delivered with an Ethernet UNI to BS sites. In these cases it might not be appropriate to require the UNI to meet Synchronous Ethernet interface limits and Interface Limit Type 2 applies as shown in Figure 34. Typically, Base Stations are designed to tolerate wander as per ITU-T G.823 [57] and ITU-T G.824 [58] traffic masks of T1/E1 interfaces, Section 4.2.1 and Reference 16 in 3GPP TS 25.411 [74]

[O16] If the CEN does not implement the synchronization reference chain according to clause 9.2.1 of ITU-T G.8261 [39] then Network limit at the UNI **MAY** be as defined by ITU-T G.823 clause 5 [57] or ITU-T G.824 clause 5 [58]

It is important to note that the looser criteria might be justified when the SP determines that the ‘End Equipment’ at the BS site can tolerate the traffic limits as specified in [O16].

14. References

MEF Specifications

- [1] MEF 3, “Circuit Emulation Service Definitions, Framework and Requirements in Metro Ethernet Networks”
- [2] MEF 4, “Metro Ethernet Network Architecture Framework Part 1: Generic Framework”
- [3] MEF 6.2, “Ethernet Services Definitions - Phase 3”
- [4] MEF 8, “Implementation Agreement for the Emulation of PDH Circuits over Metro Ethernet Networks”
- [5] MEF 9, “Abstract Test Suite for Ethernet Services at the UNI”
- [6] MEF 10.2, “Ethernet Services Attributes - Phase 2”
- [7] MEF 10.3, “Ethernet Services Attributes - Phase 3”
- [8] MEF 10.3.1, “Composite Performance Metric (CPM)”
- [9] MEF 10.3.2, “UNI Resiliency Enhancement”
- [10] MEF 11, “User Network Interface (UNI) Requirements and Framework”
- [11] MEF 12.2, “Metro Ethernet Network Architecture Framework Part 2: Ethernet Services Layer”
- [12] MEF 13, “User Network Interface (UNI) Type 1 Implementation Agreement”
- [13] MEF 14, “Abstract Test Suite for Traffic Management Phase 1”
- [14] MEF 16, “Ethernet Local Management Interface”
- [15] MEF 17, “Service OAM Requirements & Framework”
- [16] MEF 19, “Abstract Test Suite for UNI Type 1”
- [17] MEF 20, “User Network Interface (UNI) Type 2 Implementation Agreement”
- [18] MEF 21, “Abstract Test Suite for UNI Type 2 Part 1 Link OAM”
- [19] MEF 22.1, “Mobile Backhaul Phase 2”
- [20] MEF 23.1, “Class of Service Phase 2 Implementation Agreement”
- [21] MEF 24, “Abstract Test Suite for UNI Type 2 Part 2 E-LMI”
- [22] MEF 25, “Abstract Test Suite for UNI Type 2 Part 3 Service OAM”
- [23] MEF 26.1, “External Network Network Interface (ENNI)–Phase 2”
- [24] MEF 27, “Abstract Test Suite for UNI Type 2 Part 5 - Enhanced UNI Attributes and Part 6 - L2CP Handling”
- [25] MEF 30.1, “Service OAM Fault Management Implementation Agreement”
- [26] MEF 33, “Ethernet Access Services Definition”
- [27] MEF 35.1, “Service OAM Performance Management Implementation Agreement”
- [28] MEF 45, “Multi-CEN L2CP”
- [29] MEF 51, “OVC Services Definitions”

IEEE Specifications

- [30] IEEE Std. 802.1DTM-2004, “Part 3: Media Access Control (MAC) Bridges”
- [31] IEEE Std. 802.1QTM-2011, “Virtual Bridged Local Area Networks”
- [32] IEEE Std. 802.1AXTM-2014, “Link Aggregation”
- [33] IEEE Std. 802.3TM-2012, “Ethernet”
- [34] IEEE Std. 802.16TM-2009, “Air Interface for Fixed and Mobile Broadband Wireless Systems”

- [35] IEEE Std. 1588TM-2008, “Standard for A Precision Clock Synchronization Protocol for Network Measurement and Control Systems”

ITU-T Recommendations

- [36] ITU-T Y.1541, “Network Performance Objectives For IP-Based Services”, April 2002
- [37] ITU-T Y.1563, “ETH transfer performance and availability performance”, January 2009
- [38] ITU-T G.8260, “Definitions and terminology for synchronization in packet networks”, August 2010
- [39] ITU-T G.8261/Y.1361, Timing and Synchronization aspects in Packet Networks, April 2008
- [40] ITU-T G.8261.1/Y.1361.1 Packet delay variation network limits applicable to packet-based methods (Frequency synchronization), February 2012
- [41] ITU-T G.8262/Y.1362 Timing Characteristics of Synchronous Ethernet Equipment Slave Clock (EEC), July 2010
- [42] ITU-T G.8263/Y.1363 Timing characteristics of packet-based equipment clocks, February 2012
- [43] ITU-T G.8264/Y.1364 Distribution of timing through packet networks, May 2014
- [44] ITU-T G.8264/Y.1364 Amendment 1, January 2015
- [45] ITU-T G.8265/Y.1365, “Architecture and requirements for packet based frequency delivery”, October 2010
- [46] ITU-T G.8265.1, “IEEE1588TM profile for telecom (frequency delivery without support from network nodes)”, June 2010
- [47] ITU-T G.8275.1/Y.1369.1, “Precision time protocol telecom profile for phase/time synchronization with full timing support from the network”, July 2014
- [48] ITU-T G.703, “Physical/electrical characteristics of hierarchical digital interfaces”, November 2001
- [49] ITU-T G.781, “Synchronization layer functions”, September 2008
- [50] ITU-T G.803, “Architecture of transport networks based on the synchronous digital hierarchy (SDH)”, March 2000
- [51] ITU-T G.810, “Definitions and terminology for synchronization networks”, August 1996.
- [52] ITU-T G.811, “Timing characteristics of primary reference clocks”, September 1997
- [53] ITU-T G.812, “Timing requirements of slave clocks suitable for use as node clocks in synchronization networks”, June 2004
- [54] ITU-T G.812, Erratum 1 (2004), March 2009
- [55] ITU-T G.813, “Timing characteristics of SDH equipment slave clocks (SEC)”, March 2003
- [56] ITU-T G.813, Corrigendum 1 (2003), June 2005
- [57] ITU-T G.823, “The control of jitter and wander within digital networks which are based on the 2048 kbit/s hierarchy”, March 2000
- [58] ITU-T G.824, “The control of jitter and wander within digital networks which are based on the 1544 kbit/s hierarchy”, March 2000
- [59] ITU-T G.825, “The control of jitter and wander within digital networks which are based on synchronous digital hierarchy (SDH)”, March 2000
- [60] ITU-T G.705, “Characteristics of plesiochronous digital hierarchy (PDH) equipment functional blocks”, October 2005

GSM & CDMA

- [61] GSM 01.04 v8, “Abbreviations and Acronyms”, May 2000
- [62] TIA IS-2000.1-A, “Physical Layer Standard for cdma2000 Spread Spectrum Systems”, March 2000
- [63] TIA/EIA-95-B, “Mobile Station-Base Station Compatibility Standard for Wideband Spread Spectrum Cellular Systems”, (ANSI/TIA/EIA-95-B-99) (reaffirmed to TIA-95-B), March 1999

3GPP and 3GPP2 Technical Specifications

- [64] ETSI TS 145.010 v4.0.0.0, “GSM: Digital cellular telecommunication system (Phase 2+); Radio subsystem synchronisation (GSM 05.10)”
- [65] 3GPP2 C.S0002-E v2.0 (2010-06), “Physical Layer Signaling Standard for cdma2000 Spread Spectrum Systems”,
- [66] 3GPP2 C.S0010-C v2.0 (2006-03), “Recommended Minimum Performance Standards for cdma2000 Spread Spectrum Base Stations”
- [67] 3GPP TS 21.905V12.0.0 (2013-06), “Vocabulary for 3GPP Specifications”
- [68] 3GPP TS 22.278V12.6.0 (2014-12), “Service requirements for the Evolved Packet System (EPS)”
- [69] 3GPP TS 23.060v12.9.0 (2015-06), “General Packet Radio Service (GPRS); Service description; Stage 2”
- [70] 3GPP TS 23.107V12.0.0 (2014-09), “Quality of Service (QoS) concept and architecture”
- [71] 3GPP TS 23.203V12.9.0 (2015-06), “Technical Specification Group Services and System Aspects; Policy and charging control architecture”
- [72] 3GPP TS 23.236V12.0.0 (2013-06), Intra-domain connection of Radio Access Network (RAN) nodes to multiple Core Network (CN) nodes”
- [73] 3GPP TS 23.401V12.9.0 (2015-06), “Technical Specification Group Services and System Aspects; General Packet Radio Service (GPRS) enhancements for Evolved Universal Terrestrial Radio Access Network (E-UTRAN) access”
- [74] 3GPP TS 25.123V12.1.2 (2014-04), “Requirements for support of radio resource management (TDD)”
- [75] 3GPP TS 25.104V12.5.9 (2015-01), “ Base Station (BS) radio transmission and reception (FDD)”
- [76] 3GPP TS 25.105V12.1.0 (2015-01), “ Base Station (BS) radio transmission and reception (TDD)”
- [77] 3GPP TS 25.346.V12.0.0 (2014-03), “Introduction of the Multimedia Broadcast/Multicast Service (MBMS) in the Radio Access Network (RAN); Stage 2”
- [78] 3GPP TS 25.402V12.1.0 (2014-12), “Synchronization in UTRAN Stage 2”
- [79] 3GPP TS 25.411V12.0.0 (2014-09), “UTRAN Iu interface layer 1”
- [80] 3GPP TR 25.866V9.0.0 (2010-01), “1.28Mcps TDD Home NodeB study item”
- [81] 3GPP TS 25.913V8.0.0, “Requirements for Evolved UTRA (E-UTRA) and Evolved UTRAN (E-UTRAN)”
- [82] 3GPP TS 25.933V5.4.0 (2004-1), ”IP Transport in UTRAN”
- [83] 3GPP TS 36.104V12.7.0 (2015-03), ” Evolved Universal Terrestrial Radio Access (E-UTRA); Base Station (BS) radio transmission and reception”

- [84] 3GPP TS36.133V12.7.0.0 (2015-04), “Evolved Universal Terrestrial Radio Access (E-UTRA); Requirements for support of radio resource management”
- [85] 3GPP TS 36.300V12.5.0 (2015-03), “Evolved Universal Terrestrial Radio Access (E-UTRA) and Evolved Universal Terrestrial Radio Access Network (E-UTRAN); Overall description; Stage 2”
- [86] 3GPP TR36.401V12.2.0 (2015-03), ” Evolved Universal Terrestrial Radio Access Network (E-UTRAN); Architecture description”
- [87] 3GPP TR 36.842 V12.0.0 (2014-01), “Technical Specification Group Radio Access Networks; Study on Small cell enhancements for E-UTRA and E-UTRAN”
- [88] 3GPP TR 36.922V12.0.0 (2014-10), “Evolved Universal Terrestrial Radio Access (E-UTRA); TDD Home eNode B (HeNB) Radio Frequency (RF) requirements analysis”

Broadband Forum (BBF) Specifications

- [89] TR-221, " Technical Specifications for MPLS in Mobile Backhaul Networks" (October 2011)
- [90] TR-221 Amendment 1, " Technical Specifications for MPLS in Mobile Backhaul Networks" (November 2013)

IETF

- [91] RFC 791, “Internet Protocol”
- [92] RFC 1305, “Network Time Protocol (Version 3) – Specification, Implementation, and Analysis”
- [93] RFC 2119, “Key words for use in RFCs to Indicate Requirement Levels”
- [94] RFC 2460, “Internet Protocol, Version 6 (IPv6) Specification”
- [95] RFC 2474, “Definition of the Differentiated Services Field (DS Field) in the IPv4 and IPv6 Headers”
- [96] RFC 3386, “Network Hierarchy and Multilayer Survivability”
- [97] RFC 3550, “RTP: A Transport Protocol for Real-Time Applications”
- [98] RFC 4197, “Requirements for Edge-to-Edge Emulation of Time Division Multiplexed (TDM) Circuits over Packet Switching Networks”
- [99] RFC 4301, “Security Architecture for the Internet Protocol”

WiMAX Forum Specifications

- [100] WMF-T32-001-R016v01, “WiMAX Forum Network Architecture - Architecture Tenets, Reference Model and Reference Points Base Specification Stage 2. 2010-11-30”
- [101] WMF-T23-001-R015v02, “WiMAX Forum Mobile System Profile Specification, Release 1.5 Common Part, 2011-07-14”

NGMN Alliance

- [102] NGMN Alliance, “NGMN Optimized Backhaul Requirements”, August 2008
(http://www.ngmn.org/uploads/media/NGMN_Optimised_Backhaul_Requirements.pdf)

Small Cell Forum

[103] Small Cell Forum 102.02.01, “Release two – Enterprise: Overview”, December 2013

CPRI

[104] CPRI, “Common Public Radio Interface (CPRI); Interface Specification V6.0”, August 2013

Appendix A. Generic Inter-working Function (Informative)

This Appendix provides an informative definition of the Generic Inter-working Function.

The Generic Inter-working Function (GIWF) provides functionality that allows RAN CE devices with a Non-Ethernet I/F to send traffic over an Ethernet UNI. A detailed description of the GIWF is outside the scope of this document; however, the IWF definition described in MEF 3 [1] can be used as an example for a PDH based Non-Ethernet I/F.

Non-Ethernet I/F is a generic term that refers to a non-Ethernet based interface, e.g. ATM or TDM. A GIWF is only needed if the RAN CE has a Non-Ethernet I/F and therefore can not directly connect to the UNI. Figure 38 is based on the IWF defined in MEF 3 and illustrates where the GIWF would be located.

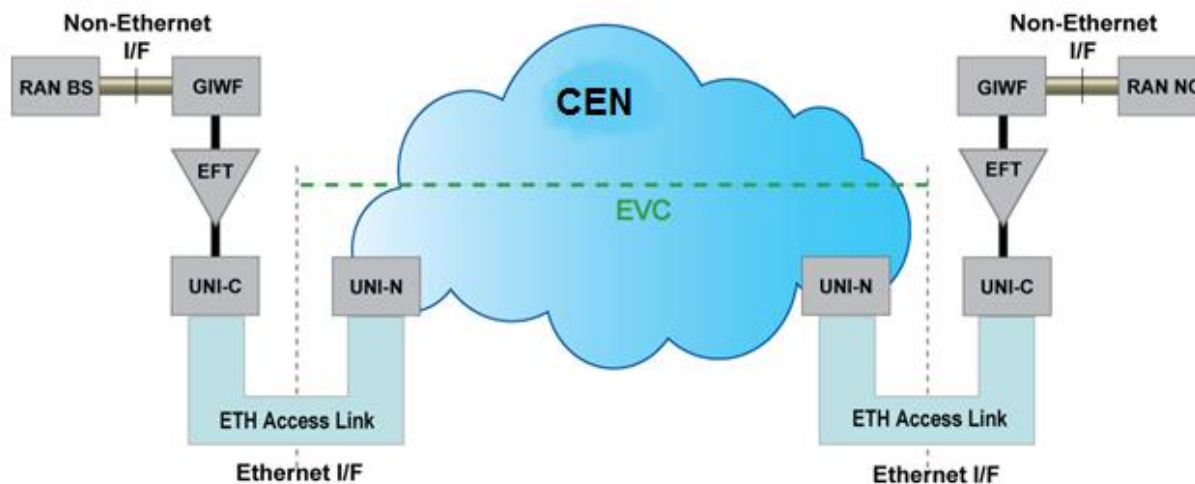

Figure 38: Generic Inter-working Function

The GIWF might perform none, part of or all the UNI-C functions. If the GIWF does not perform all the functions expected by the UNI-C then it is expected that another device is located in front of the GIWF towards the CEN that performs the remaining UNI-C functions. All ingress Service Frames from the GIWF through the Ethernet Flow Termination (EFT) point towards the UNI is conformant to the Ethernet frame format as defined in MEF 10.3 [7] and this IA of the UNI type that is used, e.g. MEF 13 [10] for UNI Type 1. The GIWF identifies traffic in a manner to allow the EFT to apply the proper CE-VLANs and/or CoS ID marking. Although the GIWF might perform some UNI-C functions, this does not imply that the GIWF must be owned and operated by the mobile network operator.

With respect to synchronization, the GIWF might contain functions to support synchronization over the CEN. The details of these functions are outside the scope of this IA but the interface requirements are specified in Section 13.2.3.

A.1 Aggregation Node

This Appendix provides an informative definition of the Aggregation Node.

BS aggregation nodes are a type of RAN CE, however they exist on the customer side of the UNI-C. In many cases, this aggregation node (e.g., a cell site gateway or router) is connected to the UNI-C. It may shape traffic, assign VLANs, assign CoS labels and so forth. However, it is not visible to the UNI-C and has no direct relation to the MEF service attributes.

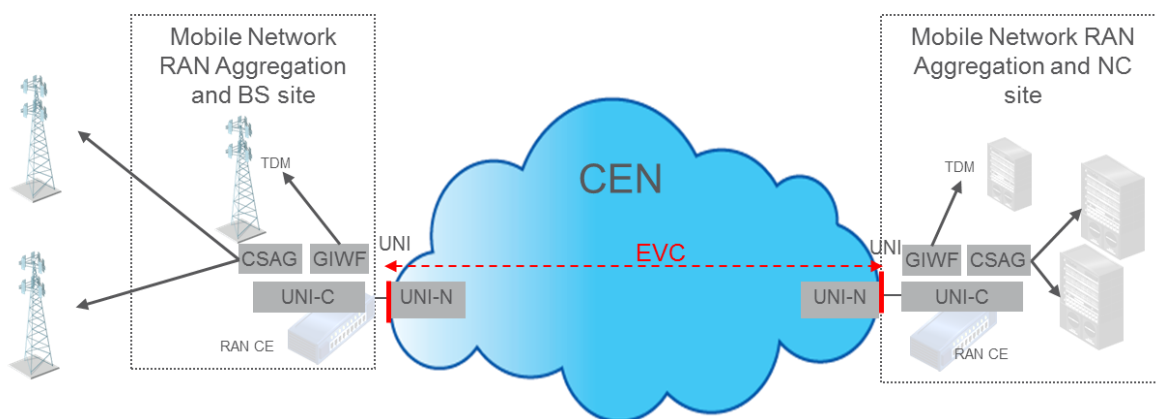

Figure 39: Aggregation node CE in RAN BS and/or RAN NC site

In Figure 39, the RAN CE is further decomposed and described for the case when a RAN BS and/or RAN NC include aggregation node CE functionality. At a BS the Aggregation node CE (CSAG) can aggregate various radio and RAN technologies and/or aggregate nearby BSs into a hub site for MBH. This can include a GIWF. The AGG function in Figure N denotes an aggregation function which can include aggregating multiple Ethernet interfaces, GIWF interfaces, and may include other functions such as IP. This is described in more detail by BBF in TR-221 where the CSG performs the aggregation functions described here. At the RAN NC site the aggregation function can similarly aggregate RAN technologies and may aggregate onto non-MEF service backhaul (e.g., IP) to a different RAN NC or Mobile Core site. This creates a hybrid backhaul arrangement. These aggregation nodes may perform other functions as well, including but not limited to resiliency (e.g., selecting among diverse EVC pair), GIWF (CES) and traffic management (e.g., CoS). The Aggregation CE can appear in variations of the previous use cases 1 and 2. Figure N is just a generic example. Variations of any of use case 1 or 2 may include Aggregation node CE as part of the Mobile Operator CE.

Appendix B. Mobile Backhaul User Traffic Classes (Informative)

Several traffic classes are identified for Mobile Backhaul. WCDMA, CDMA2000, LTE and WiMAX⁵ standards define their own user service classes. Examples of the WCDMA and WiMAX user service classes are shown below. Each user service class has performance requirements.

Traffic Class	Example Application	Fundamental Characteristics
Conversational class	Voice	<ul style="list-style-type: none"> - Conversational RT - Preserve time relation (variation) between information entities of the stream Conversational pattern (stringent and low delay)
Streaming class	Streaming video	<ul style="list-style-type: none"> - Streaming RT - Preserve time relation (variation) between information entities of the stream
Interactive class	Web browsing	<ul style="list-style-type: none"> - Interactive best effort - Request response pattern - Preserve payload content
Background	Background download of emails	<ul style="list-style-type: none"> - Background best effort - Destination is not expecting the data within a certain time - Preserve payload content

Table 16: WCDMA User Service Classes (3GPP 23.107 [67])

⁵ 3GPP does not define traffic classes for GSM.

Traffic Class	MEF CoS Name	Example Application	Fundamental Characteristics
UGS (Unsolicited Grant Service)	H	T1/E1 constant rate traffic or VoIP (without silence suppression)	For real-time uplink service flows that transport fixed-size data packets on a periodic basis, such as T1/E1 and Voice over IP without silence suppression
rtPS (real-time Polling Service)	H	Video streaming	For real-time UL service flows that transport variable-size data packets on a periodic basis, such as streaming moving pictures.
Extended rtPS	H	VoIP	Unicast uplink grants in an unsolicited manner where allocations are dynamic
nrtPS (non-real-time Polling Service)	H or M	FTP	Unicast polls on a regular basis, assuring that the UL service flow receives request opportunities even during network congestion. For applications that require guaranteed data rate but are insensitive to delays
BE (Best Effort)	L	Background download of emails, web browsing	For applications with no data rate or delay requirements

Table 17: WiMAX User Service Classes (IEEE Std. 802.16 [34])

WiMAX traffic classes, shown in Table 17, can be mapped to the MEF CoS Names based on the characteristics identified in Table 8 and the availability of 2 or 3 or 4 CoS Names at the UNI. For example, delay sensitive (e.g. FD and IFDV) traffic such as UGS traffic class for voice or rtPS for real time video streaming can use the H CoS Name and the CPOs as specified in Table 9. Traffic classes that are loss sensitive, but can be insensitive to delays, such as nrtPS could use M CoS Name, if available, or could be mapped to H CoS Name if only 2 CoS Names. Traffic classes with no performance metrics can use L CoS Name along with the option to be marked as discard eligible (yellow color).

LTE has specified the service classes in Section 6.1.7 of 3GPP TS 23.203 [71] and shown in Table 18. The forwarding treatment for performance is in terms of a QoS Class Identifier (QCI) value that is a composite indicator of the priority as well as performance for the service class. There are 9 different service classes using QCI. The transport modules of eNB and aGW are responsible to map the QCI to the transport layer's priority so as to get the required forwarding treatment across the Mobile Backhaul network.

Table 18 specifies the Packet Delay Budget (not the same as the MEF metrics as FD or MFD or FDR) and Packet Error Loss Rate (not the same as MEF metric FLR) that each service class sees from the user's equipment (UE) to the PCEF as shown in Figure 6.1.7-1 of 3GPP TS 23.203 [71]. The sections UE to RAN BS and RAN NC to PCEF are not relevant for the CPOs specified in Section 12.4.2 for the Mobile Backhaul service. The Mobile Backhaul service scope is as discussed in Sections 4 and 8 of this IA. Also, Note 2 in Table 18 mentions that the PELR is specified when network is assumed to be 'non congestion' state. So, the performance metrics mentioned in Table 18 are more applicable for the air interface, i.e., UE to RAN BS. Since these metrics are not defined the same as the MEF metrics and the scope is different from this IA the objectives stated are not easily compared to MEF CPOs.

QCI	Resource Type	Priority	Packet Delay Budget (PDB) (See NOTE 1)	Packet Error Loss Rate (PELR) (See NOTE 2)	Example Services
1	GBR	2	100 ms	10^{-2}	Conversational Voice
2		4	150 ms	10^{-3}	Conversational Video (Live Streaming)
3		3	50 ms	10^{-3}	Real Time Gaming
4		5	300 ms	10^{-6}	Non-Conversational Video (Buffered Streaming)
5	Non-GBR	1	100 ms	10^{-6}	IMS Signalling
6		6	300 ms	10^{-6}	Video (Buffered Streaming) TCP-based (e.g., www, e-mail, chat, ftp, p2p file sharing, progressive video, etc.)
7		7	100 ms	10^{-3}	Voice, Video (Live Streaming) Interactive Gaming
8		8	300 ms	10^{-6}	Video (Buffered Streaming) TCP-based (e.g., www, e-mail, chat, ftp, p2p file sharing, progressive video, etc.)
9		9			

Following NOTES are from [71]

NOTE 1: A delay of 20 ms for the delay between a PCEF and a radio base station should be subtracted from a given PDB to derive the packet delay budget that applies to the radio interface. This delay is the average between the case where the PCEF is located "close" to the radio base station (roughly 10 ms) and the case where the PCEF is located "far" from the radio base station, e.g. in case of roaming with home routed traffic (the one-way packet delay between Europe and the US west coast is roughly 50 ms). The average takes into account that roaming is a less typical scenario. It is expected that subtracting this average delay of 20 ms from a given PDB will lead to desired end-to-end performance in most typical cases. Also, note that the PDB defines an upper bound. Actual packet delays - in particular for GBR traffic - should typically be lower than the PDB specified for a QCI as long as the UE has sufficient radio channel quality.

NOTE 2: The rate of non congestion related packet losses that may occur between a radio base station and a PCEF should be regarded to be negligible. A PELR value specified for a standardized QCI therefore applies completely to the radio interface between a UE and radio base station.

Table 18: Standardized QCI Characteristics for LTE Service Classes 3GPP TS 23.203 [71]

In addition, there are control and management plane traffic types that are not included in the tables above. One way to handle these traffic types could be to bundle them into a single service class, e.g. control class. The performance expectation for this class is high availability with low frame delay and frame loss. However there may be sufficient variance in the traffic characteristics (e.g., bursty long frames for firmware upgrade vs periodic short frame FM/PM messages) and performance requirements e.g., (file transfer vs essential FM message) between different types of management traffic to justify use multiple CoS Names

Synchronization signaling could be delivered using the control class, but this would mean that control class would need to conform to the requirements of the synchronization method used to distribute timing. Alternatively, synchronization could be delivered using a separate class that would typically have stringent performance requirements.

Appendix C. Mobile Backhaul Services (Informative)

The scope of this Appendix is to provide information describing several Use Cases for delivering Mobile Backhaul with MEF 6.2 [3] services. These services run between the RAN CEs at RAN BS sites or at RAN NC sites as defined by this IA.

The use cases presented here assume that the backhaul network (CEN) is owned by a single operator (assumption made for Phase 2). These use cases are not meant to be exhaustive; additional use cases addressing different assumptions are for further study.

This section describes 5 different scenarios and related assumptions for delivering data and control plane traffic; they are referred in the following as:

1. EVPL per RAN BS
2. EVP-Tree per group of RAN BSs
3. EVP-Tree per Service
4. EVP-LAN per group of RAN BSs
5. Different EVC types for different mobile interfaces

In addition, the Appendix describes two alternatives for delivering management plane traffic.

C.1 Use Case 1: EVP Line per RAN BS

Use Case 1 illustrates a Mobile Backhaul network with a distinct EVP Line service between each RAN BS and RAN NC with the following configurations:

- The RAN NC uses a configured CE-VLAN ID to identify a RAN BS in the Mobile Backhaul network. The CE-VLAN ID is mapped at the RAN NC UNI-N and at the RAN BS UNI-N to the EVC associating the UNIs at the RAN BS and RAN NC. This implies that each RAN NC UNI can distinguish up to four thousand distinct RAN BSs.
- At the RAN NC side the CE-VLAN ID assignment is performed at the UNI-C; at the RAN BS side the CE-VLAN ID assignment can be either performed at the UNI-C or at the UNI-N, according to which option - described later in this section - is selected.
- Bundling is disabled which means that all traffic types are sent on the same CE-VLAN ID.
- Multiple Classes of Service can be supported; they are differentiated through either PCP or DSCP marking. CoS ID is identified by <EVC+PCP> or <EVC+IP>. In this use case CoS ID preservation is enabled and 4 classes of service are supported.

The EVP Line service is used for the Abis traffic in 2G networks, for the Iub traffic in 3G networks, and for the S1 traffic in LTE and for the R6 traffic in WiMAX. The EVP Line service

can be used for the X2 traffic also in LTE, assuming that the X2 traffic reaches the RNC and it is responsible to route it back to the required RAN-BS.

Both Figure 40 and Table 19 show an example of how Ethernet Services can be delivered in the Mobile Backhaul according to the assumptions made for the present use case.

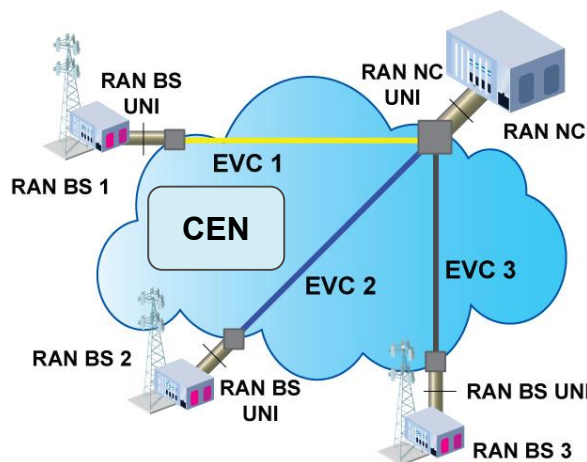

Figure 40: EVP Line per RAN BS – Use Case 1

EVC ID	EVC End Points	Ethernet Service
EVC_1	BS 1, NC	EVP-Line
EVC_2	BS 2, NC	EVP-Line
EVC_3	BS 3, NC	EVP-Line

Table 19: EVP Line per RAN BS – Use Case 1

Use Case 1 might also take into consideration additional factors that result in four possible options, each considering a different service frame format at the RAN BS UNI-C:

- **Option A:** The CE-VLAN ID Preservation Attribute is enabled and the RAN BS UNI-C transmits/receives tagged service frames to/from the RAN BS UNI-N with the CE-VLAN ID preconfigured for the RAN BS itself; either PCP or DSCP values specify different Classes of Service.
- **Option B:** The CE-VLAN ID Preservation Attribute is disabled and the RAN BS UNI-C transmits/receives untagged service frames to/from UNI-N where they are mapped to the

default CE-VLAN ID; DSCP values specify different Classes of Service. A default mapping of untagged service frames is configured at each RAN BS UNI-N.

- **Option C:** The CE-VLAN ID Preservation Attribute is disabled and the RAN BS UNI-C transmits priority tagged service frames⁶ towards the UNI-N, where they are mapped to the default CE-VLAN ID, and receives untagged frames; PCP values specify different Classes of Service. A default mapping of priority tagged service frames is configured at each RAN BS UNI-N.
- **Option D:** The CE-VLAN ID Preservation Attribute is disabled and BS UNI-C transmits/receives tagged service frames to/from UNI-N with a preconfigured CE-VLAN ID, identical for each BS. Either PCP or DSCP values specify different Classes of Service.

Options B, C and D can ease the configuration of the RAN BS because they are agnostic to the CE-VLAN ID value used to identify Service Frames in the Mobile Backhaul.

Table 20 shows an example of the CE-VLAN ID / EVC mapping for each option and the configuration both at the RAN BS UNI-N and at the RAN NC UNI-N:

EVC ID	CE-VLAN ID at RAN BS UNI-N				CE-VLAN ID at RAN NC UNI-N
	Option A	Option B	Option C	Option D	
EVC_1	10	*(7)	*	25	10
EVC_2	20	*	*	25	20
EVC_3	30	*	*	25	30

Table 20: Example of CE-VLAN ID \ EVC mapping both at RAN BS UNI-N and at RAN NC UNI-N

Table 21 shows an example of how to differentiate multiple Classes of Service with PCP values for MEF standard CoS Labels [20] on a given EVC:

⁶ The priority tagged frame is defined by MEF 10.3 as a Service Frame with an IEEE Std. 802.1Q tag in which the CE-VLAN ID field is set to 0.

⁷ The symbol * indicates the CE-VLAN ID value used at the UNI for both untagged and priority tagged frames.

CoS ID <EVC+PCP>	Class of Service	Traffic Class Example
< EVC_ID+6>	Instance of H ⁺ class	Synchronization
< EVC_ID+5>	Instance of H class	Conversational, Signaling and Control
< EVC_ID+3>	Instance of M class	Streaming
<EVC_ID+1>	Instance of L class	Interactive and Background

Table 21: Example of multiple CoS IDs based on <EVC+PCP> – Use Case 1

The CoS ID Preservation attribute should be enabled for each option in order to simplify configuration.

Note that the CoS ID per <EVC> model can also be supported by Use Case 1 if the assumption to use a single EVP Line per RAN BS that supports multiple services is removed. According to this new assumption each RAN BS can support multiple EVP Lines whereby mobile traffic classes can be grouped into different EVCs. Each EVP Line is mapped to a unique CE-VLAN ID and so each CE-VLAN ID identifies a specific set of services between the RAN NC and a specific RAN BS.

C.2 Use Case 2: EVP Tree per group of RAN BSs

Use Case 2 explores the option of associating the UNIs at RAN CEs using an EVP-Tree service with the following configurations:

- Groups of k_i ⁸ RAN BSs are uniquely identified at the RAN NC by a CE-VLAN ID⁹. Associating several RAN BSs to the same CE-VLAN ID allows one to overcome the VLAN ID address space limitation affecting the previous use case.
- An EVP-Tree is established between the RAN BSs (acting as leaves) belonging to the same group and the RAN NC (acting as root) and it is associated to the CE-VLAN ID reserved for that group of RAN BSs

⁸ k_i indicates the number of RAN BSs belonging to the i -th group. This scenario can be extended to the case of a single group including all the RAN BSs connected to the RAN NC.

⁹ Inside each group each RAN BS is uniquely identified by its own MAC address. Security issues are not taken into account in this Appendix.

- At the RAN NC side the CE-VLAN ID assignment is performed at the UNI-C; at the RAN BS side the CE-VLAN ID assignment can be either performed at the UNI-C or at the UNI-N, according to which option (A, B, C or D) is chosen (as per Use Case 1) when deploying EVP-Tree services.
- Bundling is disabled which means that all traffic types are sent on the same CE-VLAN ID.
- Multiple Classes of Service can be supported; they are differentiated through either PCP or DSCP marking. CoS ID is identified by <EVC+PCP> or <EVC+DSCP>. In this use case CoS ID preservation is enabled and 4 classes of service are supported.

The EVP-Tree service is used for the Abis traffic in 2G, the Iub traffic in 3G and for the S1 traffic in LTE.

The EVP-Tree service can be used also for the S1-Flex interface that allows each RAN-BS to be connected to multiple RAN-NC's in a pool, to support network redundancy and load balancing. For that several RAN-NC shall be part of the service as root points.

Figure 41 shows an example about how Ethernet Services can be delivered in the Mobile Backhaul according to the assumptions made for the present use case.

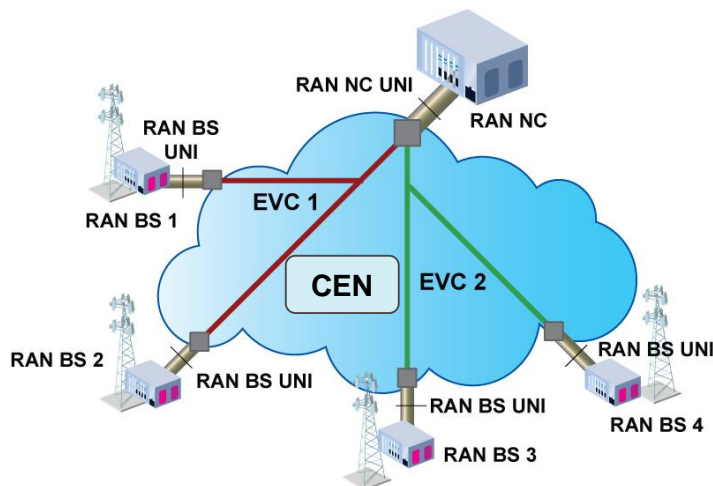

Figure 41: EVP-Tree per group of RAN BSs – Use Case 2

EVC ID	EVC End Points	Ethernet Service
EVC_1	BS 1, BS2, NC	EVP-Tree
EVC_2	BS 3, BS 4, NC	EVP-Tree

Table 22: EVP Tree per group of RAN BSs – Use Case 2

Comparing Use Case 2 with the previous one it is possible to note that Use Case 2 replicates for a group of RAN BSs, using EVP Tree services, what Use Case 1 does for a single BS, using a single EVP Line. This leads to the following conclusion: the same four options (A, B, C and D) previously described and focusing on different frame format at the RAN BS UNI-C can also be applied to Use Case 2. Refer to Table 20 and Table 21 to get an example about the CE-VLAN ID / EVC mapping and CoS ID definition for the present scenario.

C.3 Use Case 3: EVP LAN per group of RAN BSs

Use Case 3 explores the option of associating the UNIs at RAN CEs using an EVP-LAN service with the following configurations:

- Groups of k_i ¹⁰ RAN BSs are uniquely identified at the RAN NC by a CE-VLAN ID¹¹.
- An EVP-LAN is established between the RAN BSs belonging to the same group and the RAN NC and it is associated to the CE-VLAN ID reserved for that group of RAN BSs
- At the RAN NC side the CE-VLAN ID assignment is performed at the UNI-C; at the RAN BS side the CE-VLAN ID assignment can be either performed at the UNI-C or at the UNI-N, according to which option (A, B, C or D) is chosen (as per Use Case 1) when deploying EVP-LAN services.
- Bundling is disabled which means that all traffic types are sent on the same CE-VLAN ID.
- Multiple Classes of Service can be supported; they are differentiated through either PCP or DSCP marking. CoS ID is identified by <EVC+PCP> or <EVC+DSCP>. In this use case CoS ID preservation is enabled and 4 classes of service are supported.

The EVP-LAN service is used for the Abis traffic in 2G, the Iub traffic in 3G and for the S1 and X2 traffic in LTE. The EVP LAN provides direct connectivity between RAN BS neighbours that are in the same group. X2 connectivity between RAN BSs in different group shall be provided by the RAN NC routing functionality.

The EVP-LAN service can be used also for the S1-Flex interface that allows each RAN-BS to be connected to multiple RAN-NC's in a pool, to support network redundancy and load balancing.

Figure 42 shows an example about how Ethernet Services can be delivered in the Mobile Backhaul according to the assumptions made for the present use case.

¹⁰ k_i indicates the number of RAN BSs belonging to the i -th group. This scenario can be extended to the case of a single group including all the RAN BSs connected to the RAN NC.

¹¹ Inside each group each RAN BS is uniquely identified by its own MAC address. Security issues are not taken into account in this Appendix.

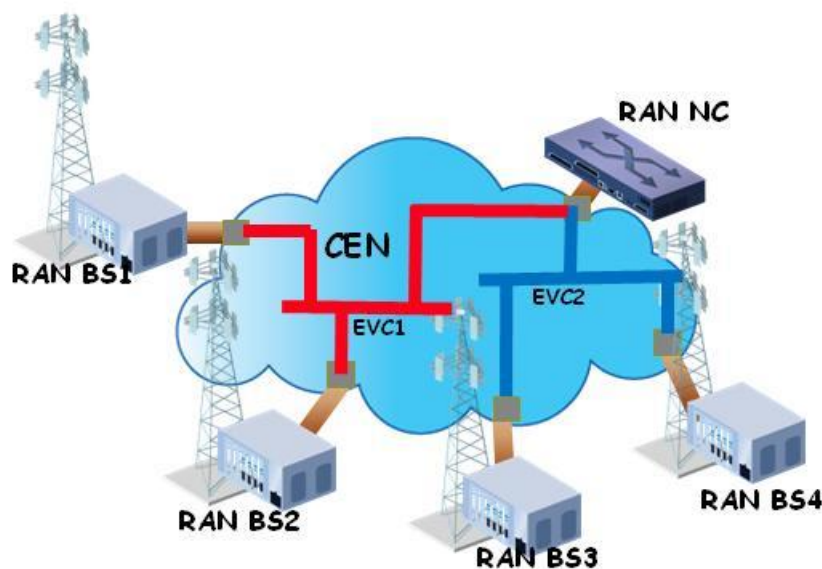

Figure 42: EVP-LAN per group of RAN BSs – Use Case 3

EVC ID	EVC End Points	Ethernet Service
EVC_1	BS 1, BS2, NC	EVP-LAN
EVC_2	BS 3, BS 4, NC	EVP-LAN

Table 23: EVP LAN per group of RAN BSs – Use Case 3

C.4 Use Case 4: EVP Tree per Service

Use Case 4 illustrates a scenario where traffic classes are separated over multiple EVP-Tree services. The configurations for this service include:

- Each CE-VLAN ID can be configured, to uniquely identify a unique service, which in turn, uniquely identifies a set of traffic classes. This means that the same set of traffic classes (i.e. voice, data, RAN signalling etc.) running between the RAN NC and two or more different RAN BSs will be identified by the same CE-VLAN ID value.
- RAN NCs will be configured as Roots and RAN BSs as Leaves
- The CE-VLAN ID tagging is performed both at the RAN BS UNI-C and at the RAN NC UNI-C. CE-VLAN ID preservation is enabled.
- Traffic classes can be differentiated through their CE-VLAN IDs; alternatively the same CE-VLAN ID can be associated to a set of traffic classes and either PCP or DSCP values can be used to differentiate among them. In other words CoS ID can be defined either per <EVC> or per <EVC+PCP> or per <EVC+DSCP>. CoS ID preservation is enabled.
- Suggested to support 4 CoS.

Figure 43 illustrates an example of how Ethernet services can be delivered in the Use Case 4.

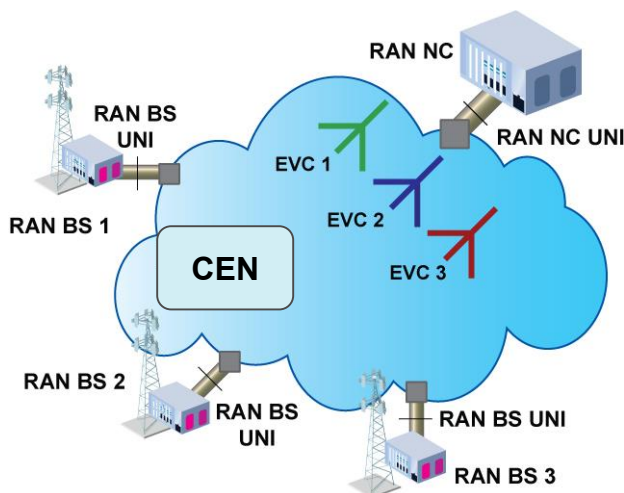

Figure 43: CE-VLAN ID per service – Use Case 4

EVC ID	EVC End Points	Ethernet Service
EVC_1	BS 1, BS2, BS 3, NC	EVP-Tree
EVC_2	BS 1, BS2, BS 3, NC	EVP-Tree
EVC_3	BS 1, BS2, BS 3, NC	EVP-Tree

Table 24: EVP Tree per Service – Use Case 4

In this scenario each RAN BS can be served by different EVP-Trees. Each RAN BS at its own UNI-C transmits/receives tagged frames to/from UNI-N with different CE-VLAN IDs: one for each different set of traffic classes. At RAN BS UNI-N each CE-VLAN ID is mapped to the correspondent EVP Tree service.

Table 25 shows through an example about the CE-VLAN ID / EVC mapping both at RAN BS UNI-N and at RAN NC UNI-N:

EVC ID	CE-VLAN ID at RAN BS UNI-N	CE-VLAN ID at RAN NC UNI-N
EVC_1	10	10
EVC_2	20	20
EVC_3	30	30

Table 25: Example of CE-VLAN ID\EVC mapping both at RAN BS UNI-N and at RAN NC UNI-N

Table 26 shows through an example how CoS Names could be defined in this scenario:

CoS ID	Class of Service	i.e. Traffic Class
<EVC_1>	Instance of H ⁺ class	Synchronization
<EVC_2+5>	Instance of H class	Conversational,
<EVC_2+5>	Instance of H class	Signaling and Control
<EVC_3+3>	Instance of M class	Streaming
<EVC_3+1>	Instance of L class	Interactive and Background

Table 26: CoS ID both per <EVC> and per <EVC+PCP> - Use Case 4

C.5 Use Case 5: Different EVC for different mobile interfaces

Use Case 5 explores the option of having different EVC's for different interfaces between RAN BSs and between RAN BS and RAN NC.

Co-location of several mobile technologies (like co location of 2G and 3G) might require different EVC for the different interfaces. For example one EVC for the Abis traffic interface in 2G, and second EVC for the Iub traffic interface in 3G.

LTE or WiMAX defines the S1 or R6 interface between RAN BS and RAN NC, and X2 or R8 interface between RAN BS neighbors, Each of those interfaces can be mapped to a different EVC with a CE-VLAN to EVC map at the UNI-N (for example, the S1 or R6 interface is mapped to an EVP-Line EVC, and the X2 or R8 interface can be mapped to an EVP-LAN EVC).¹²

Figure 44 shows an example of how Ethernet Services can be delivered in LTE Mobile Backhaul according to the assumptions made for the present use case.

¹² In this use case the RAN-BS performs necessary service classification for the S1 and X2 interfaces and maps them to different sets of CE-VLAN's.

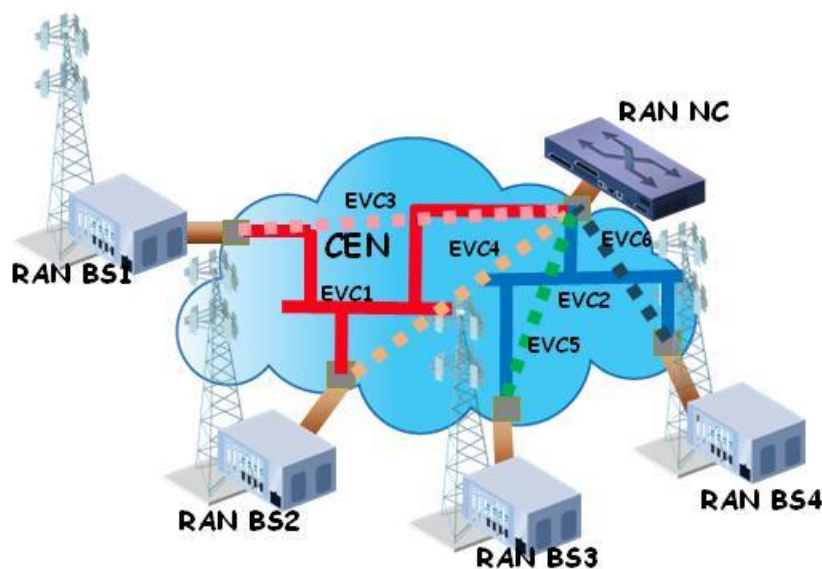

Figure 44: EVP-LAN for X2 and EVP-Line for S1 – Use Case 5

EVC ID	EVC End Points	Ethernet Service
EVC_1	BS 1, BS2, NC	EVP-LAN
EVC_2	BS 3, BS 4, NC	EVP-LAN
EVC_3	BS 1, NC	EVP-Line
EVC_4	BS 2, NC	EVP-Line
EVC_5	BS 3, NC	EVP-Line
EVC_6	BS 4, NC	EVP-Line

Table 27: EVP Tree per group of RAN BSs – Use Case 5

This use case allows connectivity between RAN BSs in the same group. This connectivity can be used for the X2 or R8 interface in LTE or WiMAX networks. The EVP LAN provides direct connectivity between neighbours RAN BS that are in the same group.

X2 connectivity between RAN BSs in different group shall be provided by the RAN NC routing functionality.

Use Case 5 can also take into consideration additional factors that result in two possible options, each considering a different service frame format at the RAN BS UNI-C:

- **Option A:** The CE-VLAN ID Preservation Attribute is enabled and the RAN BS UNI-C transmits/receives tagged service frames to/from the RAN BS UNI-N with the CE-VLAN ID preconfigured for the RAN BS itself.

- **Option B:** The CE-VLAN ID Preservation Attribute is disabled and BS UNI-C transmits/receives tagged service frames to/from UNI-N with a preconfigured CE-VLAN ID, identical for each BS.

Option B, can ease the configuration of the RAN BS because it is agnostic to the CE-VLAN ID value used to identify Service Frames in the Mobile Backhaul.

Table 28 shows an example of the CE-VLAN ID / EVC mapping for each option and the configuration both at the RAN BS UNI-N and at the RAN NC UNI-N:

EVC ID	CE-VLAN ID at RAN BS UNI-N		CE-VLAN ID at RAN NC UNI-N
	Option A	Option B	
EVC_1	10	25	10
EVC_2	20	25	20
EVC_3	30	35	30
EVC_4	40	35	40
EVC_5	50	35	50
EVC_6	60	35	60

Table 28: Example of CE-VLAN ID \ EVC mapping both at RAN BS UNI-N and at RAN NC UNI-N

C.6 Configuration alternatives for Management plane

Management plane traffic can be distributed in the Mobile Backhaul according to two main alternatives¹³ that apply to all the use cases previously presented:

- Over the same Ethernet Services instantiated for data and control plane traffic, reserving a specific CoS Name for management traffic
- Over a separate Ethernet Service exclusively for management.

¹³ Since the management plane is an issue under discussion at several Standards Development Organizations, this Appendix does not preclude description of new alternative proposals in addition to those ones already presented in this chapter.

A proposal of Ethernet Service configuration related to the latter alternative is presented in the following text.

The main general assumptions are:

- Management plane is associated to a CE-VLAN ID common to all the RAN BSs and RAN NCs.
- CE-VLAN ID tagging is performed at the UNI-C at both the RAN BS and the RAN NC.
- Different Classes of Service are supported and are differentiated through either PCP or DSCP marking.

In terms of Ethernet Services, the following configuration could be used for management:

- An EVP-Tree, associated to the common CE-VLAN ID, is established between the RAN NC (acting as root) and all the RAN BSs (acting as leaves)
- CoS IDs either per <EVC+PCP> or per <EVC+DSCP>.

Both Figure 45 and Table 29 present an example about how management traffic can be treated in Mobile Backhaul.

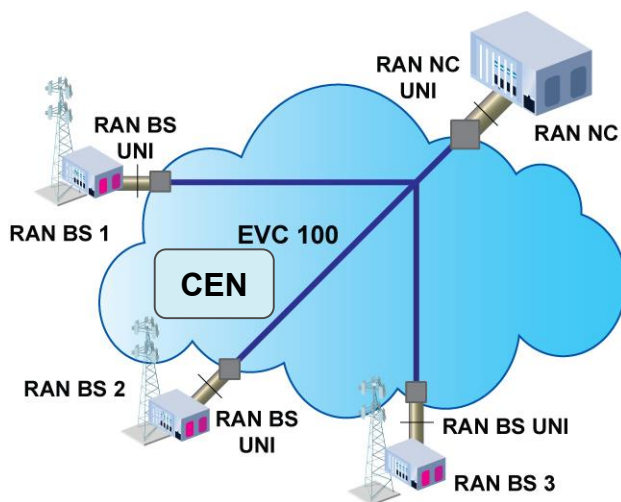

Figure 45: Ethernet Service for Management plane

EVC ID	EVC End Points	Ethernet Service	CE-VLAN ID at RAN BS UNI-N	CE-VLAN ID at RAN NC UNI-N
EVC 100	BS1, BS2, BS3, NC	EVP-Tree	150	150

Table 29: Ethernet Service configuration for Management plane – An example

Tagging is performed at the UNI-C at both the RAN BS and RAN NC sides. One-to-one mapping between CE-VLAN IDs and EVCs is done at the UNI-N at both the RAN BS and the RAN NC sides.

Enabling the CE-VLAN ID Preservation Attribute, the same VLAN ID value is maintained over the EVC easing the configuration of all the appliances in Mobile Backhaul.

The EVC reserved for management can support multiple Classes of Service: both Figure 46 and Table 30 below show such an example.

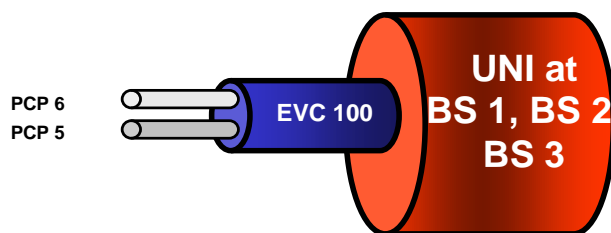

Figure 46: Multiple CoS IDs on the EVC reserved for Management traffic

CoS ID <EVC+PCP>	Class of Service	i.e. Traffic Class
< EVC 100+6>	Instance of H ⁺ class	High Priority Mgt
< EVC_100+5>	Instance of H class	Low Priority Mgt

Table 30: Example of Multiple CoS IDs on the EVC reserved to Management

The CoS ID Preservation Attribute should be enabled in order to simplify the configuration of the Mobile Backhaul.

Appendix D. Multi-CoS Backhaul with Token Sharing (Informative)

This Appendix identifies four Class of Service (CoS) Names for use for Mobile Backhaul applications. These are specified in the document and repeated here for context: {H+, H, M, L}. MEF 23.1 specifies three CoS Labels {H, M, L} and mandates Bandwidth Profile per CoS ID for those CoS Labels.

A Mobile Backhaul Service using the MEF 10.2 [6] bandwidth profile algorithm, each Class of Service instance (bandwidth profile flow) is policed independently - having the following bandwidth profile parameters {CIR, CBS, EIR, EBS, CM, CF} applied to each bandwidth profile flow. Using the MEF 10.2 model, the Customer Equipment needs to shape traffic into each flow to conform to the Ingress Bandwidth Profile parameters of the CEN. For example, ignoring the Color Mode and Coupling Flag parameters for now, the Ingress Bandwidth Profile at the UNI may be configured as follows:

- H+ CoS: CIR=1 Mbps, CBS=2*Maximum Service Frame Size (MSFS), EIR=EBS=0
- H CoS: CIR=X Mbps, CBS=4*MSFS, EIR=EBS=0
- M CoS: CIR=Y Mbps, CBS=12*MSFS, and EIR and EBS is small, to allow for some small increase in rate above the committed rate (might be required for certain applications or 'high priority' mobile users)
- L CoS: CIR and CBS is small (enough to have some committed bandwidth), and EIR=Z Mbps, EBS=24*MSFS (this CoS might be used for certain 'best-effort' applications or maybe for 'low priority' mobile users).

When designing backhaul solutions, Mobile Operators tend to think about “X Mbps per cell site”, not X Mbps per CoS for a given cell site. Separate bandwidth profiles per CoS tend to complicate the design for the Mobile Operator, even further complicated by the difference in offerings of the various backhaul providers used by the Mobile Operator. This is why many Mobile Operators desire a single CoS, using the highest performance available, even though a relatively small percentage of traffic really requires that performance level. This practice leads to a CEN that is out of balance with respect to traffic management, having Internet traffic mixed with voice and video traffic in the same forwarding class within the CEN. This can lead to over-subscription of internal CEN links and performance impacts to the highest priority traffic.

In general, Backhaul Providers would like to encourage multi-CoS behavior, since the traffic in the CEN can then be prioritized for the applications that require a given performance level.

A Mobile Backhaul Service using the MEF 10.3 [7] bandwidth profile algorithm enables a new service model using algorithm commonly referred to as token sharing. This algorithm has lots of flexibility to enable various models. Setting the parameters in a certain way can result in unused bandwidth in a higher priority flow able to be used in a lower priority flow. This may make it easier for MOs to move to multi-CoS, since the backhaul service can be designed for X Mbps per cell site. This appendix explains the token sharing algorithm, per MEF 10.3 [7], and describes two use cases that may be useful for Mobile Backhaul applications. See Section 12 of MEF 10.3 [7] for the detailed specification of Bandwidth Profiles at the UNI and Appendix C of MEF 10.3 [7] for some Bandwidth Profile use cases using token sharing. Also, Appendix A.2 in MEF 6.2

[3] shows an example of EPL with two classes and with Token Sharing Enabled at the UNIs (Figure 15 of MEF 6.2 [3]).

Token Sharing Principles

The basic concept of the MEF 10.3 [7] Bandwidth Profile algorithm is that an envelope is defined at a UNI, and each such envelope contains multiple bandwidth profile flows¹⁴, and the flows within that envelope can share unused bandwidth according to certain rules. This concept allows for different models of envelopes and flows. One such model is that the envelope can be the EVC and the bandwidth profile flows can be the Class of Service Names that are supported by the EVC. Another model could be that the envelope is more than one EVC (could be two EVCs, or more, or the whole UNI) and the flows can be either the EVCs within the envelope or the Class of Service Names within the envelope. This Appendix focuses on guidance to Mobile Operators and Backhaul Providers using a single EVC as the envelope, with the CoS Names associated with that EVC as the Bandwidth Profile Flows, and with an Ingress Bandwidth Profile used in the CEN. Figure 47 below, and the accompanying text to the left of the figure, provides a brief overview of token sharing, per MEF 10.3 [7]

¹⁴ There can also be only one Bandwidth Profile Flow in the envelope, but this model reduces to the MEF 10.2 Bandwidth Profile algorithm assuming the bandwidth profile parameters are set appropriately.

- Shared Token Policing Principles:**
- 1) Multiple flows within one envelope can share bandwidth. Flows are ranked 1 to n, lowest to highest.
 - 2) CIR, EIR controls source of tokens
 - 3) CBS, EBS controls depth of buckets
 - 4) CF^i controls sharing exc ess green tokens, per flow
 - a. $CF^i=0 \rightarrow$ down to next lower rank
 - b. $CF^i=1 \rightarrow$ across to yellow bucket of same rank
 - 5) Excess yellow tokens always flow down to next lower rank
 - 6) CF^0 controls sharing excess tokens from lowest rank green bucket to highest rank yellow bucket
 - a. $CF^0 = 1 \rightarrow$ shares excess green to highest rank yellow
 - b. $CF^0 = 0 \rightarrow$ discard excess green
 - 7) xIR_{max} limits flow of tokens into a given bucket
 - 8) Token flow can skip a rank (e.g., no yellow bucket, or $EBS = 0$ for that flow)
 - 9) Backward compatible to MEF 10.2 by constraining one flow per envelope, and making xIR_{max} sufficiently large
 - 10) Flexible algorithm allows for various deployment models

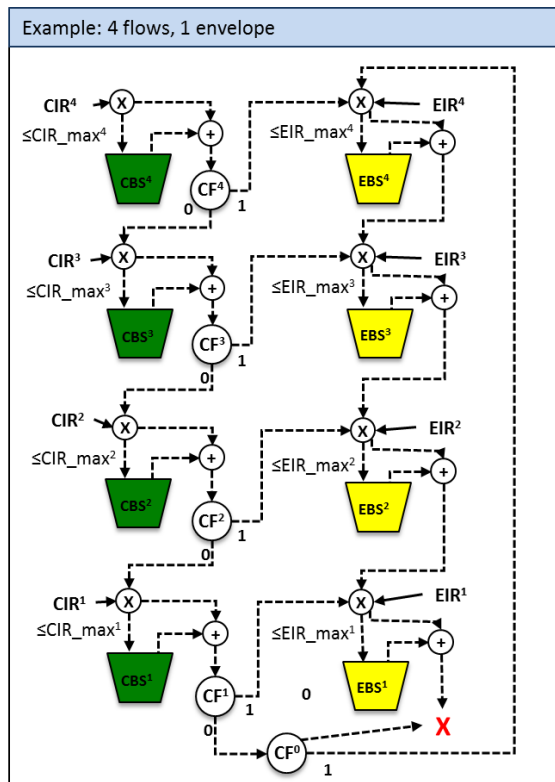

Figure 47: Summary of Token Sharing

Token Sharing Example for Mobile Backhaul

The following example is for an Ingress Bandwidth Profile applied to an envelope (the EVC connecting the RAN-BS with the RAN-NC) containing four Bandwidth Profile Flows (CoS Names {H+, H, M, L}) and applied at each UNI in the EVC. In this example, Color Mode is assumed to be Color Blind (see MEF 10.3[7]). In this example, the Mobile Operator and the Backhaul Provider agree on a template (sometimes referred to as a multi-CoS package) to be applied for EVC orders connecting a RAN-BS and its RAN-NC. An example of such a template is shown in Table 31 below.

Multi-CoS Template #1: Envelope (EVC) with four Bandwidth Profile Flows, $CF^0 = 1$				
Bandwidth Profile Parameters	H+	H	M	L
CIR (Mbps)	X	0	0	0
CIR _{max} (%)	1%	30%	30%	50%
CBS (KB)*	1*MSFS	4*MSFS	24*MSFS	24*MSFS
EIR (Mbps)	0	0	0	0
EIR _{max} (%)	0%	0%	70%	50%
EBS (KB)*	0	2*MSFS	12*MSFS	12*MSFS
CFi {0,1}	0	0	0	0

Note: CBS and EBS recommendations are expected in MEF 23.2 project; the assumption in the above table is that they would be expressed as a function of Maximum Service Frame Size (MSFS) and the amount would vary by CoS Name

Table 31: Example of Multi-CoS Template

The Mobile Operator only needs to order the CIR (X) for the EVC, the value of which could vary by cell site. CIR_{max} and EIR_{max} are shown as percentages of X. Note that the sum of the CIR_{max} and EIR_{max} values for the EVC may exceed the CIR ordered. This allows for more potential utilization of unused bandwidth for the lower priority flows during times when the higher priority flows are underutilized.

Figure 48 below shows an example of 100 Mbps required for the EVC, applied with the multi-CoS template shown in Table above.

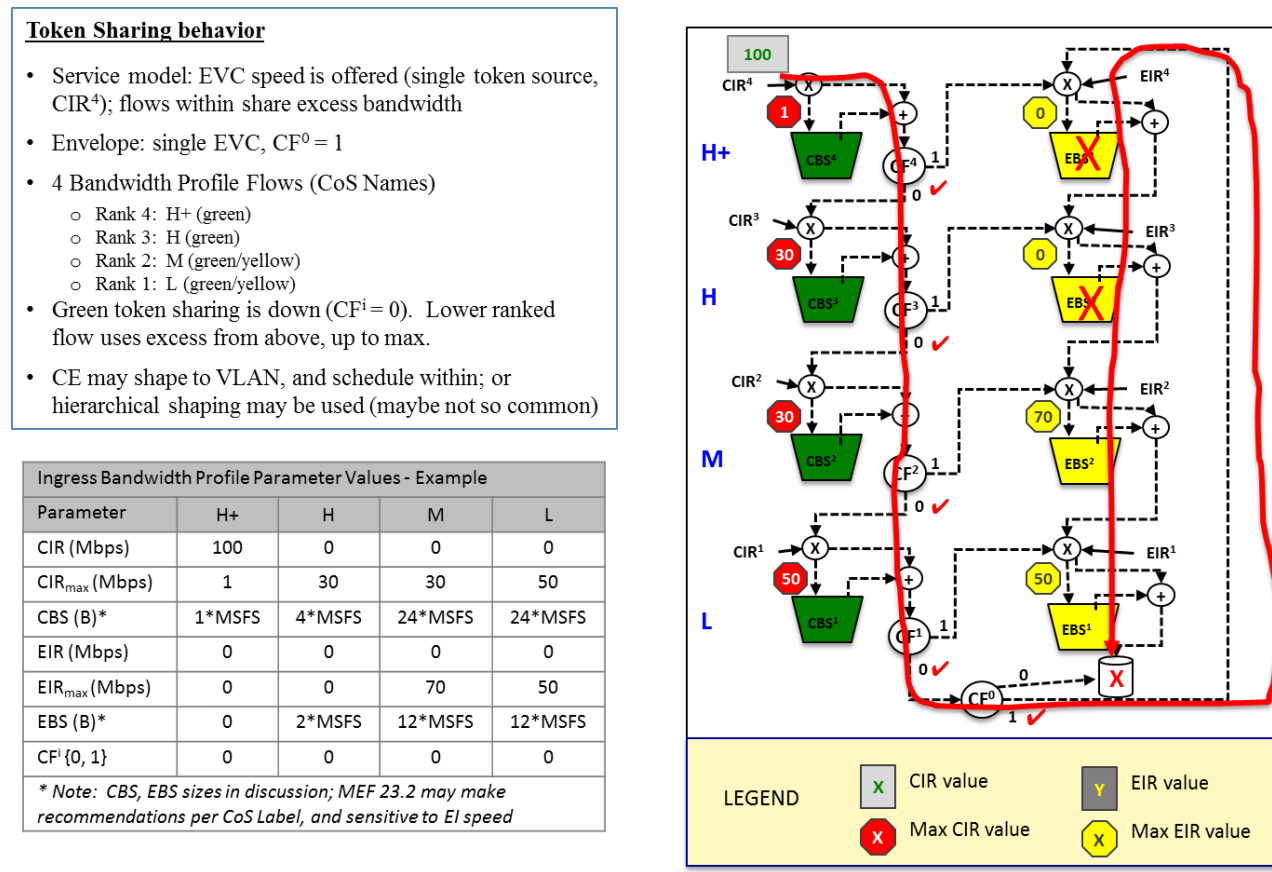

Figure 48: Example of token sharing for Mobile Backhaul

In the above example, the Mobile Operator orders an EVC with token sharing connecting the RAN-BS with the RAN-NC and specifies a CIR value of 100 Mbps, in each direction. One assumption is that the Mobile Operator and Backhaul Provider had agreed on how to package such an order. The 'package' is shown in Figure 48 above, with the Bandwidth Profile Flows and associated ranks identified and the Bandwidth Profile parameters specified.

In this example, there is a single source of tokens at the top driving the entire system, CIR^4 . It is set at 100 Mbps. The CIR_{max} values are chosen to guarantee enough committed bandwidth for each CoS Name, while allowing the excess green tokens below the bottom rank to convert to

yellow tokens to fill the top Yellow bucket. Any excess yellow tokens then cascade down the ranks of the Yellow buckets.

As can be seen, all of the CoS Names get some share of the CIR of the system. In the worst case, where all CoS Names highly are utilized in the same time period, the top three CoS Names get their CIR_{max} and CoS L gets the remaining, 39 Mbps (100-1-30-30). During times when a higher ranked Bandwidth Profile Flow is not being utilized, L CoS can get up to 50 Mbps of the system CIR. During a time period where only M and L CoS are utilized (both highly), L CoS would get 50 Mbps of CIR and M CoS would get 30 Mbps of CIR and an additional 20 Mbps of EIR. As can be seen, the CIR_{max} and EIR_{max} values can be tweaked to give more or less bandwidth to the competing Bandwidth Profile Flows.

Such a system could be extended to allow for an envelope of two EVCs, each with four CoS Names (a total of eight CoS Names) sharing the bandwidth. This might be useful in cases of two EVCs per cell site, where one is active and the other is used as standby.

Appendix E. Radio Coordination (Informative)

Standardization continues in 3GPP on LTE-Advanced features that reduce interference in the radio domain and thus increase the uplink and/or downlink speeds for the mobile handset. Any feature that reduces interference will improve the quality of experience for the end user.

Several of these features are worth understanding as they have additional timing or latency requirements for backhaul or midhaul – examples of these are summarized in Table 32: Applicable phase and time synchronization, latency, and bandwidth requirements for various radio coordination features. Note that the delivery of accurate phase/time synchronization by the mobile backhaul network has been defined by ITU-T in the PTP profile [47] (full timing support to the protocol level from the network), but is not yet included in this amendment (although it will be part of a future deliverable of this IA), so the values are shown for information. Phase/time synchronization can be provided by other means (e.g., GNSS).

Coordination	LTE / LTE-A feature	Time synch <i>common reference accuracy</i>	Latency	Bandwidth
Moderate	Range expansion	None ⁴	None ⁴	Low
Moderate	Adaptive resource partitioning	None ⁴	None ⁴	Low
Moderate	Inter-Cell Interference Coordination (ICIC)	None ⁴	None ⁴	Low
Moderate	eICIC	+/- 1.5us +/- 5 us	None ⁴	Low
Moderate	Dual Connectivity	TBD ³	5-30ms ³	TBD ³
Tight	CoMP - UL Coordinated Scheduling	+/- 5 us	1-10 ms ¹	Low
Tight	CoMP - UL Coordinated link adaptation	None ⁴	1-10 ms ¹	Low
Tight	CoMP - DL Coordinated Scheduling	+/- 5 us	1-10 ms ¹	Low
Tight	CoMP - DL Coordinated link adaptation	None ⁴	1-10 ms ¹	Low
Very Tight ²	CoMP - DL Coordinated beamforming	+/- 1.5 us	< 1 ms	2.5-10 Gbps

Very Tight ²	CoMP - DL non-coherent joint transmission	+/- 5 us	< 1 ms	< 150 Mbps
Very Tight ²	CoMP - UL Joint processing	+/- 1.5 us	< 1 ms	2.5-10 Gbps
Very Tight ²	CoMP -UL Selection combining	+/- 5 us	< 1 ms	< 150 Mbps

Notes:

3GPP Standardization is ongoing in this area, as such this table is a snapshot of the anticipated requirements. See [71] and [87].

¹ No strict requirement, performance benefit reduces with higher latency

² Very Tight coordination case is out of scope for this phase

³ Backhaul characteristics to be determined depending on 3GPP release 12 conclusions 3GPP Standardization is ongoing. See [72]

⁴“None” - no other requirements than the FDD or TDD system requires, and can be supported with MEF 22.1 [19]

Table 32: Applicable phase and time synchronization, latency, and bandwidth requirements for various radio coordination features

Several 3GPP defined coordination and interference cancellation techniques are described below, with emphasis on the impact on the backhaul:

1. Range Expansion
2. Adaptive resource partitioning
3. ICIC
4. eICIC / FeICIC
5. CoMP Coordinated Scheduling (or Dynamic Point Selection)
6. CoMP Beamforming
7. CoMP non coherent joint transmission
8. CoMP joint processing (transmission/reception)
9. Dual connectivity

Range Expansion

With the deployment of multiple small cells within the macro coverage area, more “cell-edge” is created. Conventionally, the LTE handset (UE) associates with a base station with best downlink (DL) signal-to-interference-plus-noise-ratio (SINR). However, a handset with larger macro

SINR may have lower path loss to the nearby small cell base station. The result is significant UL interference at the small cells.

Range expansion (see Figure 49), which has been possible since 3GPP Release 8, can be used to expand coverage area for the small cell. Instead of SINR, the UE association can also be determined by minimal path loss. A handover bias is set to indicate the handover trigger between the macro and small cell. Intelligent association achieves better spectrum efficiency and network capacity, lower interference per bit and a spatial reuse efficiency similar to cell splitting.

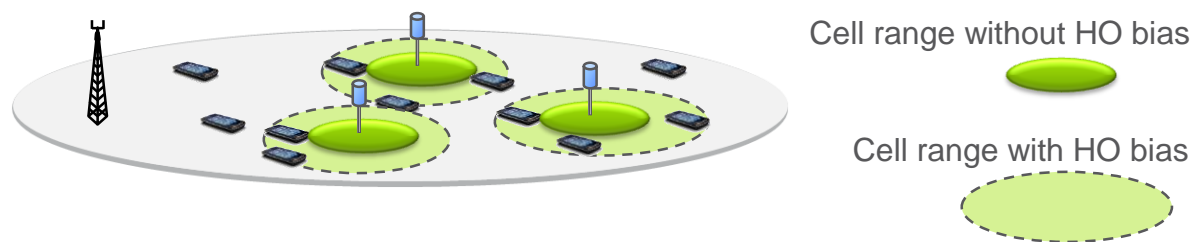

Figure 49: Range expansion shown with handover (HO) bias.

Adaptive resource partitioning

The basic radio resource for OFDM transmission can be described as a two-dimensional

time-frequency grid that corresponds to a set of OFDM symbols and subcarriers in the time and frequency domains. In LTE, the basic unit for data transmission is a pair of resource blocks that correspond to a 180kHz bandwidth during a 1ms subframe. Therefore, by aggregating frequency resources and by adjusting transmission parameters, such as modulation order and channel code rate, one can flexibly support a wide range of data rates.

Resource partitioning should adapt to network loading, backhaul availability, topology, SINR conditions at UE/base station, mobility, QoS, traffic patterns, etc. Distributed, adaptive resource partitioning schemes are essential to manage interference and optimize throughput performance in heterogeneous networks

The nodes in the network negotiate their resource reservation by sending messages to each other. These resource request/grant messages can be sent over backhaul connections or OTA. The slow adaptive resource negotiation algorithm is based on node load status and feedback from active UEs and updates every few hundred ms. Dynamically adaptive resource negotiation algorithm is better with bursty traffic (temporarily loaning resources between nodes) but requires OTA signaling.

- › Latency: no special requirement

Scheduling

In general, scheduling refers to the process of dividing and allocating resources between users who have data to transfer. In LTE, dynamic scheduling (1ms) is applied both to the uplink and downlink. Scheduling should result in a balance between perceived end-user quality and overall system performance. Channel-dependent scheduling is used to achieve high cell throughput. Transmissions can be carried out with higher data rates by transmitting on time or frequency resources with relatively good channel conditions. The OFDM time-frequency grid facilitates the selection of resources in the time and frequency domains -- LTE supports persistent scheduling and dynamic scheduling.

ICIC - frequency domain partitioning

In some cases, the macro and small cell can use separate carriers to avoid strong interference. In this case, carrier aggregation gives flexibility in managing the interference. Essentially, the macro cell transmits at full power on its primary carrier frequency and lower power on the second carrier frequency. The small cell then uses the second carrier frequency as its primary carrier.

While this does not require time synchronization, it also offers less granular resource allocation as partitioning is limited by the number of carriers. As a result, this does not scale beyond a few small cells per macro cell.

- › Latency: no special requirement

eICIC / FeICIC – time domain partitioning

Enhanced ICIC, is essentially time domain partitioning of resources in such a way to minimize the interference between the macro cell and the small cell in a large range expansion (also called handover bias) operation. That is, when the UE is intentionally locked onto a weak DL small cell.

With a range expansion of RE dB, a user connected to a small cell can be hit by one or more interfering downlink signals from macro cells that are RE dB stronger than the desired signal – plus the handover margin. With a moderate value of RE , that is, a moderate cell selection offset, the radio interface is robust enough to handle this situation. For larger values of cell selection offset, the macro cells can be muted or made to use reduced power. This may be done in a static or traffic adaptive pattern. Care must be taken not to mute the macro too often, which might lead to worse performance since the (overloaded) macro cell becomes even more loaded during its active periods.

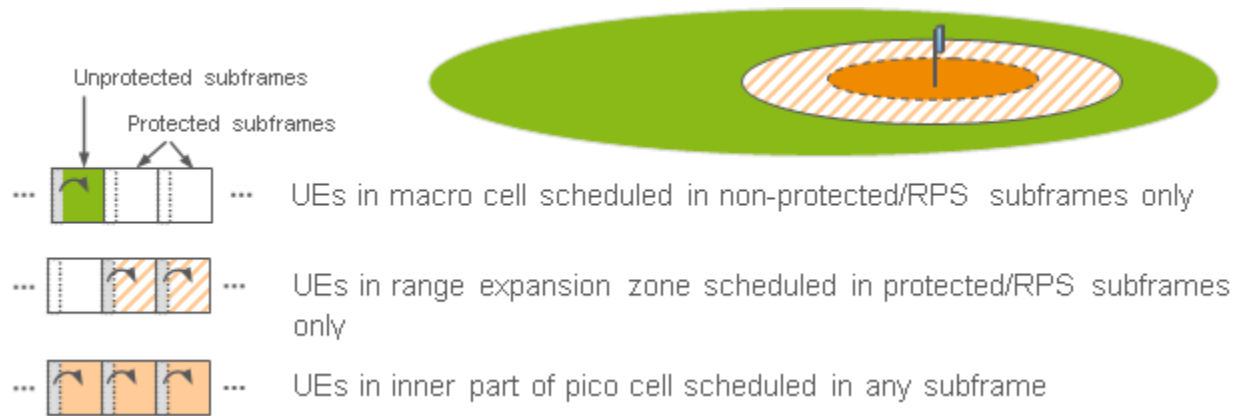

Figure 50: enhanced Inter Cell Interference Coordination (eICIC)

This is supported in LTE by static and adaptive Almost Blank Sub-frames (ABS) and Reduced Power Sub-frames (RPS). To support large cell selection offsets, almost blank subframes (ABS) were introduced in LTE release 10. One drawback of this approach is that when the data channel in the macro base station is completely switched off, there is a degradation in performance for users connected to the macro base station. The reduced transmission time leads directly to lower data rates, which leads indirectly to increased load (higher resource utilization) for the same amount of carried traffic. This effect can be mitigated by not completely switching off the macro data channel in the ABS, but instead reducing the power to a level that the small cell users can support. This concept is referred to as reduced power subframes (RPS). Capacity gains of up to 100 percent have been seen in 3GPP-defined scenarios

Using the LTE eICIC concept, the macro base stations schedule RPSs in a periodically repeated pattern. The pattern is signaled to neighbor base stations to enable them to schedule users in the imbalance zone when the macro power is reduced. The fraction of RPSs in the pattern can be adapted to the traffic situation. This is known as adaptive RPS. RPS is preferred over ABS as it more efficiently utilizes resources in all sub-frames.

eICIC consists of three design principles

1. Time domain interference management (Rel-10)

Severe interference limits the association of terminals to small cells

2. Cell range expansion (Rel-10/11)

Time domain resource partitioning enables load balancing between macro and small cells. Resource partitioning needs to adapt to traffic load

3. Interference cancellation receiver in the terminal (Rel-11/12)

Ensures that weak cells can be detected and interference removed.
Inter cell interference cancellation for control and data channels

The latter principle is sometimes referred to as a further enhanced ICIC (FeICIC).

- › Time alignment: +/-1.5us -- +/-5us required between macro and small cell
- › Latency: no special requirement (>20ms)

Coordinated Multipoint (CoMP)

Coordinated Multipoint is effectively a network MIMO utilizing multiple antennas at different cell sites, all of which have visibility to the handset (UE).

For Downlink (DL) CoMP, this is explicitly supported from 3GPP Rel-11 and mostly relies on UE feedback. This results in a medium performance benefit.

Uplink (UL) CoMP currently has little 3GPP specification impact as it is mainly based on implementation and inter-node communication. That is, it is similar to soft/softer handover. However, this can result in a large performance benefit. There are several CoMP methods that have been defined in Rel 11 and that will be further enhanced in Rel 12.

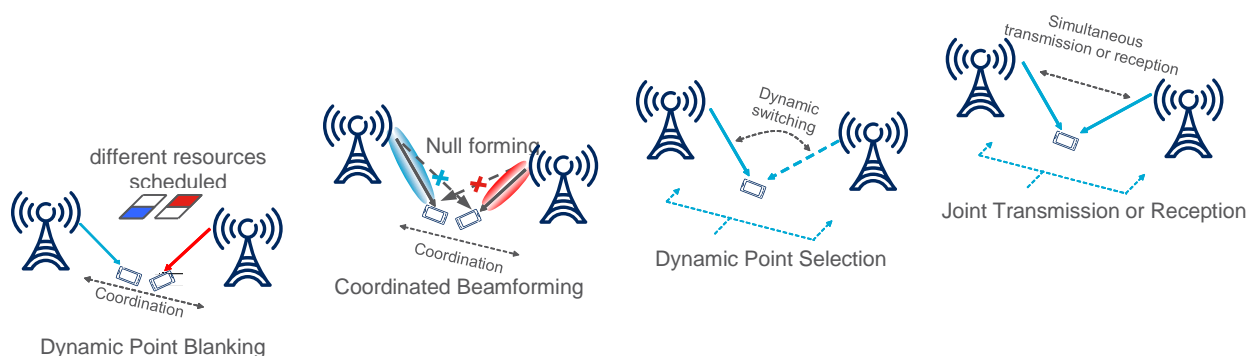

Figure 51: Several options of CoMP (Coordinated Multipoint)

Coordinated Scheduling / Dynamic Point Blanking

Coordinated scheduling is a CoMP method in which a joint scheduling decision is taken across a set of cells, rather than letting each cell's scheduler operate independently. As an example, using coordinated scheduling a macro base station might be silent or use reduced power, only when a nearby small cell base station schedules a user that would have been heavily interfered by the macro base station, such as a user in the imbalance zone. Coordinated scheduling is also known as 'dynamic point blanking' and corresponds to fully dynamic ABS/RPS.

Essentially, the UE receives data from single TX point. Scheduling of time/frequency resources is coordinated among points. This exchange of coordination information between points, is on a per TTI (transmission time interval) level (i.e., every 1ms).

- › Time alignment: +/-1.5us required between macro and small cell
- › Latency: 1..10ms – the lower the latency, the better the cell edge gain

Joint Reception

CoMP joint reception is a UL CoMP method that involves precise scheduling of UE on the uplink. The CoMP base stations receive the transmitted data from the UE. One base station is the master as they share received data and jointly process it. A communication between the UE and master base station (ACK/NACK) as well as to the other base station is required.

- › Time alignment: +/-1.5us required between macro and small cell
- › Latency: <0.5ms

Dual Connectivity

Dual connectivity (3GPP 36.300 [85]) involves a UE consuming radio resources from at least two different base stations(master and secondary) connected with midhaul or backhaul (both called “non-ideal backhaul” in 3GPP). This results in a UL/DL split between the base stations that increases throughput and decreasing HO signalling. While the DL split is specified in Release 12, the UL split is under study in Release 13. In the case where this is deployed with an X2 interface between the master eNB and a secondary eNB the requirements on this midhaul connection can be relaxed and support latency of up to 30ms and have sufficient bandwidth.

- › Latency: 5-30ms

Appendix F. Multi CEN Use Cases for Mobile Backhaul (Informative)

This Appendix identifies the possible use of OVC services per MEF 51 [29], using examples of possible deployments. In the examples described in this appendix, we assume that a Mobile Operator, *MO*, buys EVC services (see MEF 6.2 [3]) from a Backhaul Service Provider *BH* to connect UNIs at various cell sites with one or more UNIs at the aggregation site. From the *MO* perspective, there is one backhaul CEN. In fact, *BH* may use a chain of OVC Services from different Operators to provide the EVC service required by *MO*.

The business arrangements are generally unconstrained, e.g.,

Mobile Operator and *Backhaul Service Provider* may be separate companies, or separate business units within the same company. The *Mobile Operator* is responsible for the mobile service, and the *Backhaul Service Provider* is responsible for the EVC Service.

Backhaul Service Provider and *CEN Operator* may be separate companies, or separate business units within the same company. The *Backhaul Service Provider* may or may not own a CEN. In typical deployments, it does own a CEN, but the MEF constructs allow for flexibility.

CEN Operator is best viewed as an independent Operator, chosen by the *Backhaul Service Provider* for delivering a component (an OVC Service) of the EVC service. It is the *Backhaul Service Provider's* responsibility to ensure that the OVC service can support the end-to-end EVC service. It is the individual *Operator's* responsibility to ensure that the OVC Service performs as stated. As stated earlier, there may be a chain of OVC Services (across multiple Operator CENs) to support an EVC service.

This appendix gives examples of multiple CENs supporting EVC Services for mobile backhaul applications, and is based on the OVC Services definitions [29]. In addition, guidance is provided on the relationship of the EVC and OVC service attributes.

Example of EVPL Service

Figure 52 below depicts two EVPL services. Note that multiple EVPL services can be supported at each UNI.

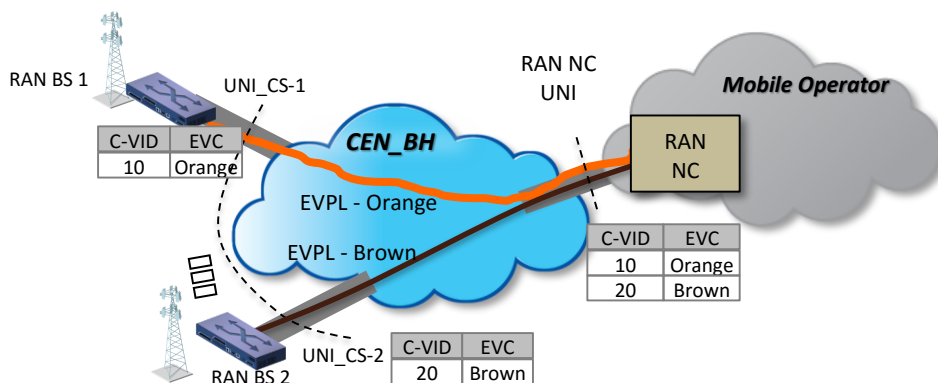

Figure 52: Example of two EVPL services used for Mobile Backhaul

In Figure 52 above, *BH* uses the Orange EVC to connect UNI_CS-1 with the RAN NC UNI, and the Brown EVC to connect UNI_CS-2 with the RAN NC UNI.

We assume that *BH* is responsible for the end-to-end EVPL services, but it does not have a CEN that can provide connectivity to each of the cell sites. So, *BH* buys a chain OVC services from multiple Operators to support the EVPL services.

Figure 53 below depicts an example of three CENs involved in supporting the two EVPL services with four Access E-Line Services.

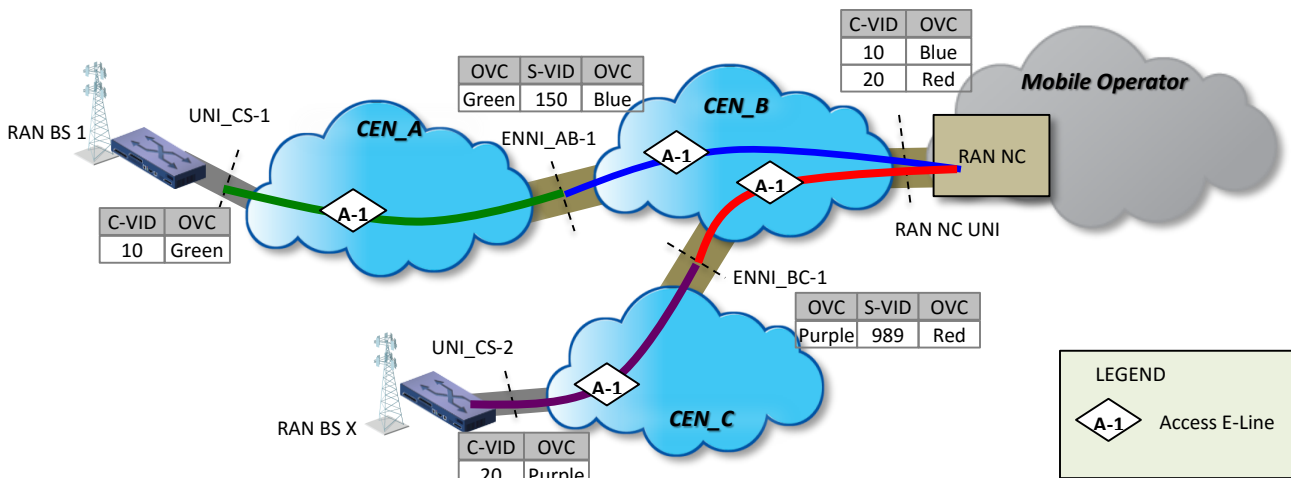

Figure 53: Example of three CENs supporting EVPL with Access E-Line Services

An Access E-Line service (Green) is used in CEN_A to connect the UNI_CS-1 with ENNI_AB-1. Another Access E-Line Service (Blue) is used in CEN_B to connect the RAN NC UNI with ENNI_AB-1. The two OVCs are interconnected at ENNI_AB-1 using S-VLAN ID of 150, completing the connectivity for the Orange EVPL service shown in Figure 52. Similarly, two OVCs are used in CEN_C and CEN_B to support the Brown EVPL service shown in Figure 52 between UNI at Cell Site 2 with the RAN NC UNI.

A different potential arrangement of OVC Services is shown in Figure 54 below, i.e., an example of four CENs involved in supporting the two EVPL services with four Access E-Line Services and two Transit E-Line Services. CEN_D might be required in some deployments for reach or for ease of connectivity to the 'last mile' Operators.

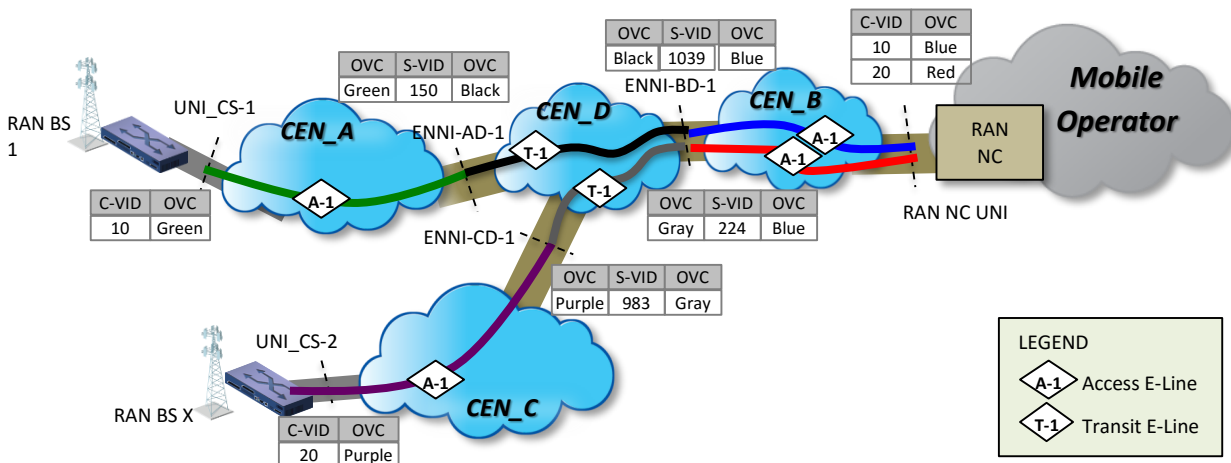

Figure 54: Example of four CENs supporting EVPL with Access E-Line and Transit E-Line Services

As can be seen in Figure 54 above, the Black and Gray Transit E-Line Services are used to extend the end-to-end EVPL Services across the Transit Operator's CEN_D.

Example of EVP-LAN Service

Figure 55 below depicts one EVP-LAN service, which is used to connect UNIs at several cell sites with each, and also providing connectivity back to the RAN NC UNI. The MO may decide to use this service for the X2 interface application. Note that multiple VLAN based services can be supported at each UNI.

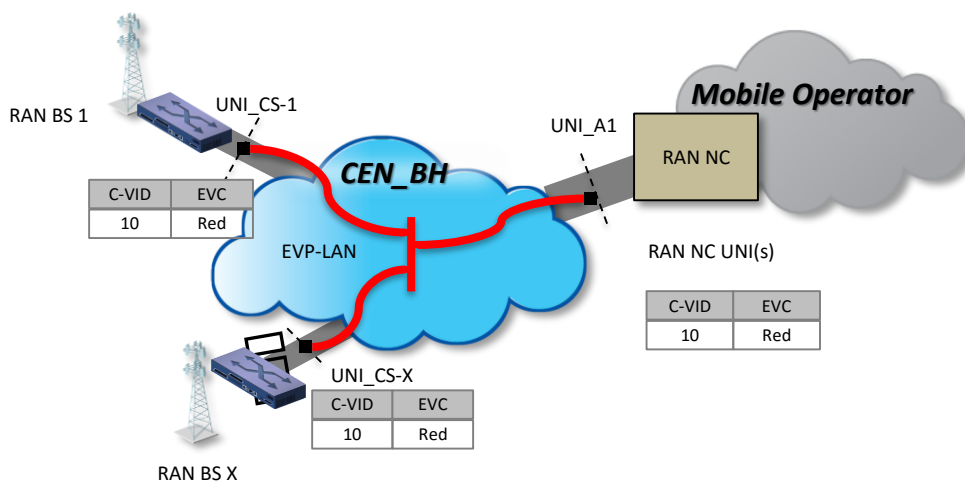

Figure 55: Example of one EVP-LAN service used for Mobile Backhaul

In Figure 55 above, BH uses the Red EVC to connect UNI_CS-1 with other UNIs at other cell sites, including UNI_CS-X, with the RAN NC UNI.

As in the EVPL example, we assume that BH is responsible for the end-to-end service, but may not have connectivity to each cell site from its network. So, BH buys OVC services from multiple Operators to support the EVP-LAN service. Note that at least one of the OVC Services in the chain needs to use a multipoint-to-multipoint OVC to support the EVP-LAN service.

Figure 56 below depicts an example of four CENs involved in supporting the EVP-LAN Service, with three Access E-Line Services and one Transit E-LAN Service.

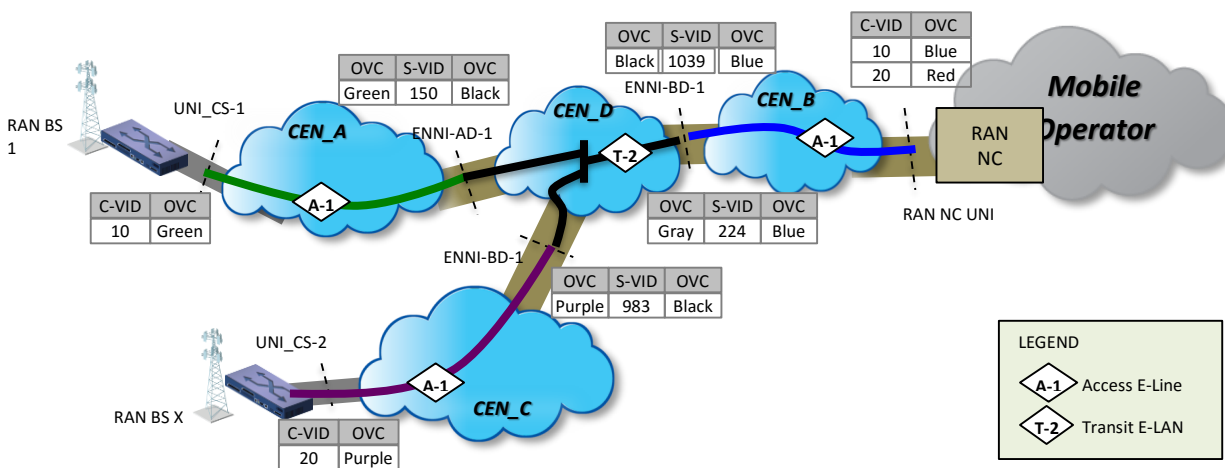

Figure 56: Example of four CENs supporting EVP-LAN with Access E-Line and Transit E-LAN Services

This service topology fits to a model where tight control of multipoint service features is required. In this example, last mile Access Operators provide the point-to-point spokes (the Access E-Line services) to the Transit Operator's CEN (CEN_D), where the bridging is done. It should be noted that a similar solution could be used without CEN_D, using instead an Access E-LAN service in CEN_B.

A different arrangement shown in Figure 57 below which supports the EVP-LAN Service with two Access E-LAN Services, two Access E-Line Services and two Transit E-Line Services.

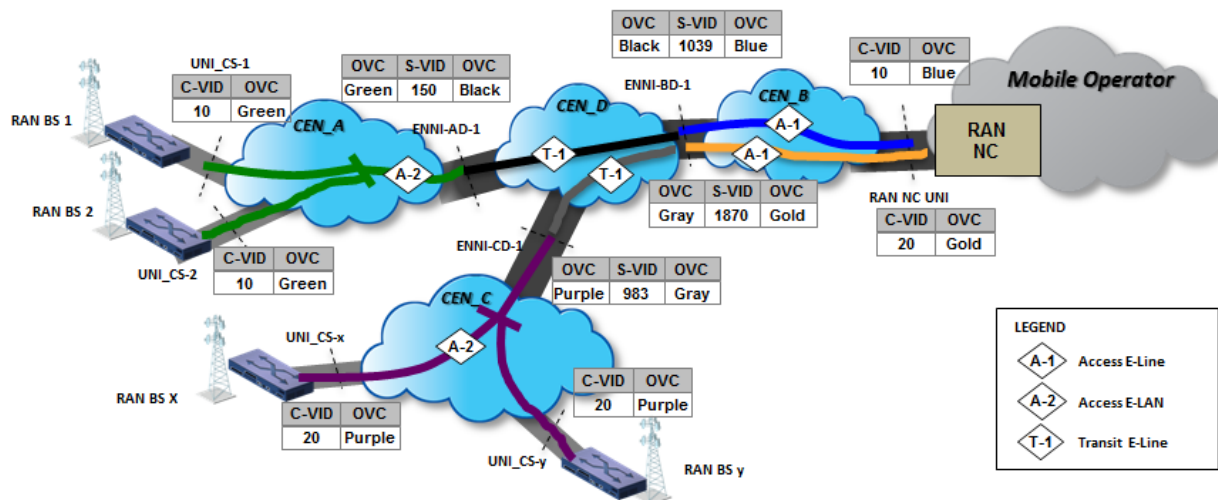

Figure 57: Example of supporting distributed EVP-LAN Services

This arrangement is similar to the one described previously, but now CENs A and C provide bridging capability among the cell sites using an Access E-LAN Service in each CEN. This service topology fits to a model where local bridging is required to ensure tighter control of delay performance and to keep local traffic (e.g., X2) local to the CEN providing access to the cell sites.

As described in the above examples, a solution with a single multipoint-to-multipoint OVC in the chain may be preferred in some deployments since it can be operationally simpler to use, i.e., the bridging functionality is done in one CEN and issues related to MAC address limits or rate limiting of multicast and broadcast traffic can be managed more easily by a single Operator. The other OVC Services in the chain can use point-to-point OVC services. A solution with more distributed bridging functionality in multiple CENs might be preferred in other cases, e.g., where the Access Operator's CENs are small, and local bridging is required across more than one CEN; such an approach may help to keep the X2 traffic among a cluster of cell sites, ensuring better frame delay performance among those UNIs.

Relationship of EVC and OVC service attributes in support of multi-CEN Mobile Backhaul

In multi-CEN deployments, Service Providers and Operators need to agree on the details of the OVC service attributes so that the chain of OVCs can support the end-to-end EVC Service. See

Appendix A of OVC Services [29], which provides detailed guidance on the relationship of the EVC and OVC attributes.
